

3 1761 06335385 8

LIVING

PIGMIES.

# The 'N. & G.' Kinematographic

ts.

capable of  
Photography  
Lantern

nary  
y as

The 'N  
Co  
recor  
light  
surfa  
cover  
Siz  
quite

for  
Day-  
ring  
any,

Extra £  
Abso

and  
) 0

The 'N  
Bes  
and u  
negat  
Elect

tion  
the  
l for  
) 0

The 'N  
Co  
made  
base  
or 'N

well  
able  
ier,  
) 0



The Library  
of the  
David Dunlap Observatory

Presented by  
..... Dr. C. A. Chant.....

Dec. 3, 1935

Automatic winders for same.

£ 15 0

## Complete Developing and Drying Set of Apparatus.

Made of well-seasoned wood to stand any climate. £15 15 0

PERFORATING MACHINES for hand or power.  
FILMS, BOBBINS, WINDERS, and all  
ACCESSORIES and SUNDRIES.

Illustrated Catalogue, Threepence, Post Free.

# NEWMAN and GUARDIA, Limited,





Digitized by the Internet Archive  
in 2010 with funding from  
University of Toronto



DAVID DUNLAP  
OBSERVATORY/900  
LIBRARY

The ~ ~ ~

# 'N. & G.' Cameras - -

## for Hand and Tripod.

Have been in Constant Use for . . .

 **More than Seven Years**

. . . in all Parts of the World.

**EIGHT DISTINCT PATTERNS** † **ALL ONE QUALITY . .**  
TO †  
**SUIT EVERY REQUIREMENT** † **The Highest**

**Prices from £13 to £50.**



The Neatest and Best **FOR ALL-ROUND WORK :**

**SPECIAL PATTERN B:** Zeiss "Satz" Lens, 2 foci; Double Rising Front; Double Extension. Price from **£21 10 0**

The Best **FOR SCIENTIFIC WORK** and General Photography :

**SPECIAL TWIN-LENS PATTERN:** Two Zeiss "Satz" Lenses, 2 foci; Rising Front; Double Extension, Double Bellows, Full-size Focussing Device, highly efficient in any light. Price from **£35 0 0**

New Pattern **FOR HIGH-SPEED WORK** and General Photography :

**HS PATTERN:** Zeiss "Planar,"  $f/3.8$  Lens; Focal-plane Shutter and "Standard" Lens Shutter. Total Range of Exposure from  $\frac{1}{1000}$  to "time" at will. Price from **£25 0 0**



**COMPLETE CATALOGUE**, 80 pages, 7 x 10 in, Art Paper, containing 112 Illustrations, including 60 Reproductions from Original Negatives by Leading Workers. Price 1s. 3d. by Post.  
"A Lesson to Picture Makers."—*Photography*.

† **ABRIDGED  
LISTS  
FREE.**

Sole London Agents for **PROF. JOLY'S Process of PHOTOGRAPHY IN NATURAL COLOURS.**  
A thoroughly *bona fide* and Practical Process. As simple as ordinary Photography. Full Particulars on Application.

**LENSES, TRIPOD CAMERAS, and all kinds of  
PHOTOGRAPHIC APPARATUS,  
ACCESSORIES and MATERIALS.**

**90 & 92, Shaftesbury Avenue, London, W.**



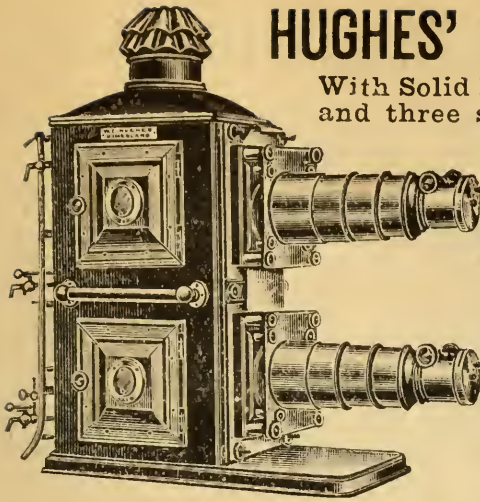

## HUGHES' SPECIAL BIUNIAL,

With Solid Brass Telescope Draw Tubes and three sets of Lenses for different distances. Price £13 13s.

**This is the greatest value ever offered.**

Handsome polished Mahogany body (lined with iron), elegant solid brass fronts, registering screws, diaphragm shutter for rolling curtain effect, Malden dissolving top, and two blow-through safety jets. £13 13s.

## HUGHES' MAGNUM - - MIXED GAS JET.

APPROXIMATELY 2,000 CANDLE-POWER.

**A JET OF JETS.**

*A Light of Great Whiteness.*



The most perfect and reliable Jet on the market, constructed on a new principle. Improved Hemmings' Safety, perfected after exhaustive experiments and splendidly made. All screwed and cast, and highly finished. Two mechanical movements. Portable, unique, economical; will fit any lantern. Limes  $1\frac{1}{4}$  diameter can be used with advantage.

No. 1. **PRICE ... .. £3 10 0**

*Specially adapted for the Cinematograph because it is safe.*

No. 2 **PRICE ... .. £2 18 0**

*For Theatres and ordinary work. Not so well finished and usual lime pin.*

Before purchasing send for grandly Illustrated Catalogue, over 180 fine Engravings, not commercial blocks, but original, of the largest and finest assortment of Magic Lanterns, Grand Effects, &c., in the world. Price 6d., postage 3d. 60,000 Slides, List 4d., postage 2d.

**W. C. HUGHES,** Brewster House, 82, Mortimer Road, Kingsland, London, N.  
Specialist in Optical Projection. ESTABLISHED OVER 30 YEARS.

[See following pages.]

# STREET CINEMATOGRAPHS

OR OUTDOOR THEATRE.

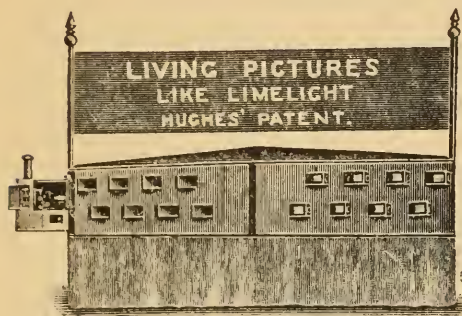

*A Palpable Hit!*  
*A Huge Success!*

*Greatest Money-Taker of the Nineteenth Century.*

\* \* \*

**HUGHES' New Patent  
PHOTO ROTOSCOPE**

## DUPLEX STREET CINEMATOGRAPH. . . .

Forty can see at one time. Results beyond anything yet accomplished. Coins money

Is not an Automatic Toy Machine. Large Living Pictures in the Open Air.

## Hughes' Duplex Street Cinematograph

Price £38 10s. complete.

## HUGHES' STREET CINEMATOGRAPHS.

Twenty People can see at once. A tremendous success. Price £21 10s. complete. Illustrated Particulars of above 3d.

HUGHES' LIVING PICTURE

## *Photo Rotoscope.*

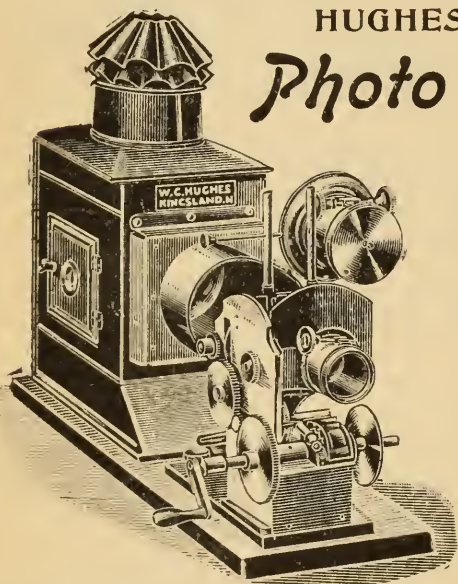

A little gem instrument, flickering reduced to a minimum, can be attached to any lantern, will give with oil 4ft. pictures; Limelight 10ft. to 14ft. pictures. Price, complete with lantern, No. 1 £13 13s.; without £9 9s. No. 2 £15 15s. and £11 11s.; superior to many machines on the market costing from £20 to £30 each.

Grandly Illustrated Cinematograph List of above machines, developing apparatus, cameras, jets, screens, &c., post free 6d. Films Lists, 3d. Essay on Cinematographs, valuable help, 4d. Illustrated Film List, 6d. Illustrated Second-hand Lists of lanterns, slides &c., bargains, 3d.

Established over 30 years.

**W. C. HUGHES,** Specialist in Optical Projection,  
BREWSTER HOUSE, 82, MORTIMER ROAD, KINGSLAND, LONDON, N.



ANIMATED PHOTOGRAPHY IN A NUTSHELL.

THE AMATEUR COMBINED LA PETITE  
**Cinematograph Snap-shot Camera**

Printer, Projector, Reverser,  
 fitted with high-class Lenses

Price complete **£6 6s.**

A splendidly constructed piece of  
 apparatus, technical and perfect.

THE LA PETITE

AMATEUR PROJECTOR.

For Projecting, Reversing, and  
 Enlarging only.

Price **£3 17s. 6d.**

Lanterns from **21/-** to **30/-** each,  
 with oil lamp.

Sensitive Films, positive and neg-  
 ative, 25ft. **3/6** each.

Films Subjects for above **10/-** each.

*Every Pater, Son, Grandson, Etc., should  
 possess one. Living Pictures of Friends,  
 Children, Etc. Lists Free.*

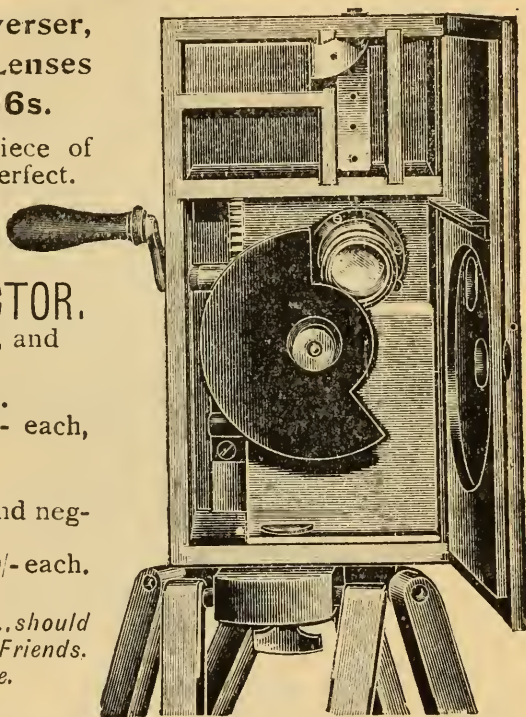

If you want a first-class Oil Lighted Lantern, have . . .

**HUGHES' MARVELLOUS PAMPHENGOS**

Nearly 4,000 sold, pictures like limelight. Price **£6 6s.**, reduced  
 to **£4 4s.**; the **£4 4s.** reduced to **£3 10s.**

Before purchasing, get Hughes' Grandly Illustrated Catalogue of  
 High-class Lanterns, Triples, Biunials, Novelties and Effects, as sup-  
 plied to Madame Patti, Prof. Malden, Dr. H. Grattan-Guinness, Royal  
 Polytechnic Institution, &c. 180 choice original engravings, price 6d.,  
 postage 4d. List of 60,000 slides, post free, 6d.

Grandly Illustrated Cinematograph List of above machines, develop-  
 ing apparatus, cameras, jets, screens, &c., post free, 6d. Films Lists,  
 3d. Essay on Cinematographs, valuable information, 4d. Illustrated  
 Film List, 6d. Illustrated Second-hand Lists of lanterns, slides, &c.,  
 bargains, 3d.

THE CHEAPEST & BEST.

ESTABLISHED OVER 30 YEARS.

**W. C. HUGHES**, Specialist in Optical Projection,

Brewster House, 82, Mortimer Road, Kingsland, London, N.

# ANIMATED PICTURES.

HUGHES' GREAT

Motor-

Pictoroscope

*By Royal Letters Patent.*

Can be used without a Shutter, therefore absolutely no Flickering.

The consummation and embodiment of great improvements on all other Cinematograph Machines.

**ADVANTAGES**—New Piston Plunger for gently drawing down the film, therefore never tears or injures. New Film Cage; films are never scratched or defaced. New focussing arrangement for Lenses, useful and clever. New Automatic Miniature Art Picture Frame.

**PRICE £47 10s.**

complete, ready for use. With high-class Mahogany Lantern, cushed and lined with asbestos.

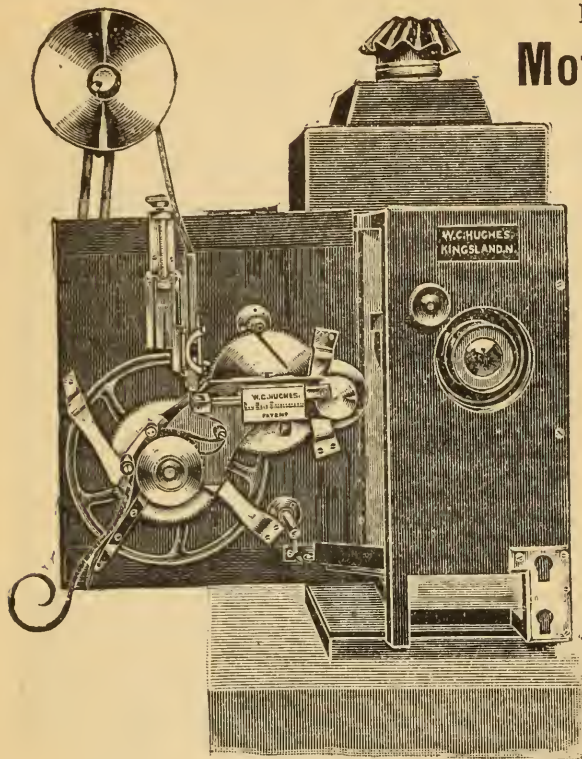

HUGHES' MOTO BIJOU

## Living Picture Camera.

The latest and most approved Camera for amateur Photography. Can be used as a Camera and as a Printing Machine.

**SIMPLICITY,  
THEREFORE  
PERFECTION.**

The adjustable shutter enables the operator to alter the slot from 3in. to  $\frac{1}{4}$ in. opening to suit subject. Most carefully and scientifically constructed

**Price £15 15s.**

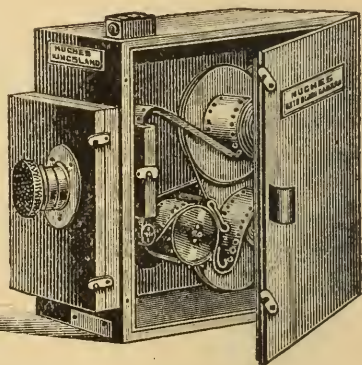

**HUGHES' MOTO BIJOU MAGAZINE CAMERA**, for taking 500 to 1000 lengths of Films. Price £35. A Magnificent Instrument, has taken the most perfect negatives.

**HUGHES' COMPLETE DEVELOPING AND FIXING APPARATUS FOR FILMS.** The most simple and effective. Price £6 10s.

**GRANDLY ILLUSTRATED CATALOGUE** of Motor-Pictoroscope, Photo Rotoscope Peepshow Cameras, Developing Apparatus, &c., &c., post free, 6d. Hughes' Instructive Essay on Cinematographs, 4d. Two Grandly Illustrated Film Lists, 8d. Ordinary Film Lists, 2d., post free.

**W. C. HUGHES, Specialist,** Brewster House, 82, Mortimer Rd., Kingsland, LONDON, N.

ESTABLISHED 30 YEARS.

[See preceding pages

LIVING PICTURES.





# LIVING PICTURES :

THEIR HISTORY, PHOTO-PRODUCTION  
AND PRACTICAL WORKING.

WITH

*A Digest of British Patents and Annotated  
Bibliography.*

BY

HENRY V. HOPWOOD.

"Our swift scene flies, in motion or no less celerity than that  
of thought."—*K. Henry V.*, Act iii., lines 1-3.

---

THE  
OPTICIAN & PHOTOGRAPHIC TRADES REVIEW,  
123-5, FLEET STREET, LONDON, E.C.

1899.



~~1335~~

TR  
850  
H6  
1899

# CONTENTS.

---

	PAGE
PREFACE      ...      ...      ...      ...      ...      ...	xi—xii
CHAPTER I.—Persistence of Vision and Continued Perception of same Object.	
Persistence—Colour Tops—Optic Wonder—Thaumatrope invented jointly by Herschel and Fitton—Stereo-Thaumatrope      ...      ...      ...      ...      ...	1—8
CHAPTER II.—Illusion of Motion, produced by successive Views of slightly varying Diagrams.	
Wheel - Phenomena — Phenakistoscope—Anorthoscope—Wheel of Life — Choreutoscope — Dædaleum — Zoëtrope—Praxinoscope—Alternate Views—Book-form Apparatus—Mutoscopes—Viviscope ...      ...	9—42
CHAPTER III.—Chronophotography and the Practical Development of the Living Picture.	
Posed Photographs—Pure Chronophotography—Battery Apparatus — Jansen's Photo - Revolver — Marey's Photographic Gun—Early Attempts at Intermittent Motion of Band—Kinetoscope—First successful Machines — Jenkin's Phantoscope — Cinématographe—Kinetic Lantern      ...      ...      ...      ...	43—109
CHAPTER IV.—Present Day Cameras and Projection Apparatus.	
Classification of Intermittent Mechanism — Modern Suggestions and Actual Machines—Nomenclature...	110—187

## CHAPTER V.—Films: their Production and Treatment.

Celluloid — Perforation — Exposure — Development —  
 Printing Positives—Colouring—Repairing... .. 188—206

CHAPTER VI. — Exhibiting Hints, Accessories,  
 Lighting, Accidents, etc.

Vibration—Flicker—Correct Adjustment of Film and  
 View—Reversing—Safety Appliances—Lighting—  
 Screens—Peep-show Apparatus ... .. 207—224

## CHAPTER VII.—Past, Present, and Future.

Who Invented Living Pictures?—Gradual Progress of  
 Invention—Present Uses—A Flight of Fancy ... 225—234

APPENDIX I. — Chronological Digest of British  
 Patents ... .. 235—253

APPENDIX II.—Annotated Bibliography ... .. 254—265

GENERAL INDEX ... .. 266—275

COMMERCIAL SUPPLEMENT ... .. i—xxvii

## PREFACE.

---

IN presenting this book to my readers I feel the necessity of making a few remarks with regard to its scope. The subject of which it treats is, in earlier years, so bound up with researches on Persistence of Vision that I have been sorely tempted to stray into many seductively interesting bye-paths. Limitations of time and space have, however, exercised a certain influence, and I have been compelled to restrict my work in absolute conformity with the title of my book. Therefore, none of the interesting apparatus for demonstrating persistence of vision find a place within these pages, nor have the various theories on the subject been discussed. I have somewhat reluctantly confined myself strictly to the description and history of apparatus for producing the illusion of motion. At the same time, my book (within its proper limits) commences early, and, at the conclusion of a review covering over two thousand years, will be found, I hope, fully "up to date." I have adopted the practice of italicising the name of each instrument when first met with in the Historical Section, and the Index will be found to include, in alphabetical order, not only names properly applied, but also such mis-spelled variations as I may have met with, and also many which have been erroneously used, they, like "the flowers which bloom in the spring," having "nothing to do with the case." The changes rung on Kine-, Cine-, and Vita- are so numerous—one might say irritating—that I am led to hope that the mathematical laws of permutation may break down, and, in defiance of arithmetical rules, thus create a necessity for radical changes in the naming of later machines. The descriptions in the list of British Patents must not be taken as full; I see no necessity to reprint a mass of Government Blue-books

which are available in full to the public, but I believe that every specification pertinent to my subject is at least mentioned, and I am convinced such a list is a necessary complement to an historical review. Furthermore, these patents will be found to include many ideas which may contain some useful germs, and although many of these crude conceptions have not been practically carried out, they at least afford food for thought. An acquaintance with the minuteness of the steps in the evolution of the Living Picture has caused me to attach value to even the slightest novelty, find it where I might. With regard to the Bibliography, I do not put it forward as exhaustive. Were it so, the valuable papers would be hidden among a number of reprints and comments. I merely append some of the more important references I have collected in the course of my reading, in order that others may pursue any point on which they desire further information than I have been able to supply in the space at my disposal. To this end the Index is especially directed; I believe its utility will justify the labour I have expended upon it. In conclusion, I would say that my aim has been to express each fact as clearly as possible in a popular way, and to present in a connected form as much information as I could collect, in order that my book might not only provide a few hours' pleasant reading, but also serve as a standard of reference on its subject. Finally, I should esteem it a favour if any reader who discovers an error, either of commission or omission, in my work would acquaint me with the fact, for "to err is human"; and I should be pleased to find my critics approach the other extreme of the proverb cited.

HENRY V. HOPWOOD.

*January, 1899.*



## CHAPTER I.

### PERSISTENCE OF VISION AND CONTINUED PERCEPTION OF THE SAME OBJECT.

IN all branches of applied science the reflective mind derives pleasure from tracing a perfected instrument back to its simplest form, thus separating its primary and essential factor from those mechanical improvements and additions which serve to render the apparatus perfect in action and commercially practicable. For instance, the telescope and microscope, the use of which has carried man's sight farther and farther into the boundless realms of the infinitely great and immeasurably small, derive their utility, when all is told, from the fact that a ray of light is bent out of its path when passing through any point where a change of (optical) density exists in the material universe. The reason of this it is not necessary to enquire into ; the experimental fact is accepted on its own merits while the possibility is admitted of some underlying verity which may prove the connecting link between this and other related phenomena, and still further simplify the expression of the natural laws governing them. And thus pursuing our present subject and considering the marvellous mechanism which brings the past in all semblance of vivacity under present view, it is only necessary to ascertain the fundamental fact which renders possible so wonderful a result. But, instead of analysing the finished apparatus for ourselves, it is best to take our starting-point from others, and at once prepare to follow from its primitive germ the growth of the Living

Picture—a history which could never have been written were it not for the physiological phenomenon of Persistence of Vision, that basis upon which rests every one of the mechanical appliances which will be described.

The stock experiment which proves Persistence of Vision is of so elementary a character that man must be supposed to have noticed the effect long before he was capable of theorising upon its cause. If a stick with lighted or glowing point is taken and whirled in a circle (an action doubtless performed in prehistoric times), it will be at once noticed, if the speed is great enough, that the glowing end of the stick is no longer seen as a point; but a luminous circle filling its whole path is visible instead. Again, take a flat steel spring and fix it at one end, strike the other so as to cause it

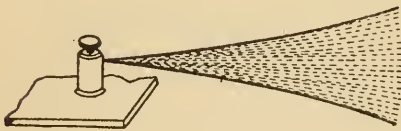

FIG. 1.

to vibrate, and the spring will appear to fill the whole of the space over which it moves, as seen in Fig. 1. Now it certainly does not require much proof that neither stick nor spring can be in two places at once; and the only possible solution of the mystery is that the luminous point or spring is seen in any given spot after it has moved away, and continues to be visible there until its return to the same position, when its image again falls on the same spot in the eye and thus gives an impression of continuous presence. This taking place all along the path of the moving object naturally causes it in appearance to fill the whole space. Fortunately this, as most other experimental facts, admits of simple verbal expression—one sentence suffices—we continue to experience the visual effect of light after it has ceased to act. This phenomenon is called,



as already mentioned, Persistence of Vision, and from this point we make our departure; the investigations and theories respecting the cause of this effect, whether residing in the brain-cells' slow return (after their excitation) to normal state, or connected with the nature of the stimulus experienced by the terminal of the optic nerve in the retina, are all interesting; but they do not alter the experimental fact of persistence, which is certainly true, even though all the theories hitherto promulgated with respect to it should prove to be erroneous.

A sentence, which is probably the first written reference to persistence of vision, is contained in the fourth book of "De rerum natura," by Lucretius, dated about 65 B.C. He there says: "This [perception of movement] is to be explained in the following way; that when the first image passes off, and a second is afterwards produced in another position, the former then seems to have changed its gesture. This we must conceive to be done by a very rapid process," etc. Though seemingly so very *à propos* this passage is in reality only a reference to a theory of dreams, and its interest arises from the fact that Dr. Plateau found it quoted against him (by Dr. Sinstedden) on the invention of the phenakistoscope; and it seems of some interest as being the first-quoted anticipation of the first living picture apparatus. Indeed Lucretius only expresses the *fact* of persistent vision and mentions no *apparatus* for its demonstration.

This matter appears to have been first treated of two centuries later in the second book of Ptolemy's Optics. This work, written about the year 130 A.D., narrowly escaped annihilation; only two copies are known to exist, and these are both Latin translations through the Arabic. One copy is in the Bibliothèque Nationale in Paris, the other and more perfect example is in the

Bodleian Library at Oxford. Ptolemy in this treatise mentions that if a sector of a disc be coloured, the whole will appear of that colour when rapidly revolved, and if the sector be variously coloured at different distances from the centre, the disc will appear ringed. Alhazen, the great Arabian philosopher, refers to the subject about A.D. 1100, as do others, including Leonardo da Vinci, who was born in 1452. Coming to later years, Newton, Boyle, and others mention the matter, but little practical investigation was done except the attempts by Segner, d'Arcy, and Cavallo to measure the duration of vision after the extinction of light. To conclude the references on this subject, it is only necessary to mention that the period of persistence is now accepted as (on the average) from  $\frac{1}{10}$  to  $\frac{1}{24}$  of a second, subject to the degree of intensity, duration, and colour of the light received by the eye.

Up to the end of the eighteenth century no progress was made in the *application* of the principle of persistence, and the character of last-century knowledge is well summed up in Abbé Nollet's "Leçons de Physique," 1765, tome 5, where he says: "When an object moves very rapidly before our eyes, we often attribute to it size and shape which it does not possess. A polyhedron revolved on its axis seems to us a sphere; as does also a circle revolved on one of its diameters," etc., etc. This statement merely implies the knowledge that one object may be seen in more than one place at once if it move fast enough; and here may be mentioned a very popular toy of thirty odd years ago, brought out by the Stereoscopic Company under the name of "The Optic Wonder." In this a piece of wire bent to the outline of one side of a vase or the like symmetrical figure was made to revolve rapidly round its vertical axis, and thereby gave the impression of a complete vessel. As an addition a glass rod, bent

to a half outline of a glass shade and mounted outside the wire, caused the appearance of a complete transparent covering. Later, a heavy metal top was used to obtain rotation, the wires being inserted in a hollow vertical spindle. This toy was manufactured in France and known under the name of "La Toupie éblouissante," or Dazzling Top (Fig. 2). These toys were, of course, manufactured subsequently to the date as yet reached in this review of progress, but have most connection with this stage of the whole subject.

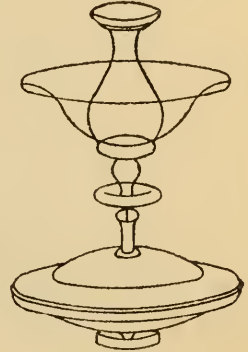

FIG. 2.

So, up to the year 1825, demonstration was confined to exhibiting *the same object in more than one place* at once; but in 1826 or thereabouts it was rendered possible to see *two different objects in the same place at the same time*. This was accomplished by the *Thaumatrope*, the invention of which is attributed by Brewster to Dr. Paris, who himself claimed it in his book, "Philosophy in Sport made Science in Earnest." It consists of a card having images on each surface,

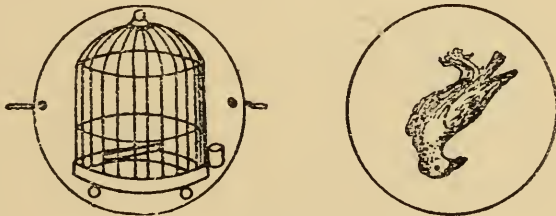

FIG. 3.

inverted with respect to each other, as in Fig. 3, and these images (when presented in rapid alternation by the revolution of the card) both persist, and so appear simultaneously and continuously present in the field of view. With reference to the general acceptance of Dr.

Paris as inventor of this instrument (which Carpenter attributes to Dr. Wollaston), it is well to notice the following little known story from Charles Babbage's "Passages from the Life of a Philosopher" [Autobiography]. "One day Herschel [Sir John], sitting with me after dinner, amusing himself by spinning a pear upon the table, suddenly asked whether I could show him the two sides of a shilling at the same moment. I took out of my pocket a shilling, and holding it up before the looking-glass, pointed out my method. 'No,' said my friend, 'that won't do'; then, spinning my shilling upon the table, he pointed out his method of seeing both sides at once. The next day I mentioned the anecdote to the late Dr. Fitton, who a few days after brought me a beautiful illustration of the principle. It consisted of a round disc of card suspended between two pieces of sewing-silk. These threads being held between the finger and thumb of each hand, were then made to turn quickly, when the disc of card, of course, revolved also. Upon one side of this disc of card was painted a bird; upon the other side, an empty bird-cage. On turning the thread rapidly the bird appeared to have got inside the cage. We soon made numerous applications, as a rat on one side and a trap upon the other, etc. It was shown to Captain Kater, Dr. Wollaston, and many of our friends, and was, after the lapse of a short time, forgotten. Some months after, during dinner at the Royal Society Club, Sir Joseph Banks being in the chair, I heard Mr. Barrow, then Secretary to the Admiralty, talking very loudly about a wonderful invention of Dr. Paris, the object of which I could not quite understand. It was called the thaumatrope, and was said to be sold at the Royal Institution, in Albemarle Street. Suspecting that it had some connection with our unnamed toy, I went next morning and purchased for seven shillings and



sixpence a thaumatrope, which I afterwards sent down to Slough to the late Lady Herschel. It was precisely the thing which her son and Dr. Fitton had contributed to invent, which amused all their friends for a time and had then been forgotten. There was, however, one additional thaumatrope made afterwards. It consisted of the usual disc of paper. On one side was represented a thaumatrope (the design upon it being a penny piece) with the motto, 'How to turn a Penny.' On the other side was a gentleman in black, with his hands held out in the act of spinning a thaumatrope, the motto being 'A New Trick from Paris.'"

To conclude the history of the Thaumatrope a reference to a suggestion made by Claudet in 1867 is alone necessary. In the ordinary form both sides of the card revolve around the same axis at the same distance, and therefore appear on the same plane. But Claudet suggested that if the card were of considerable thickness or a substitute were provided (similar to a shallow matchbox cover), and the axis of rotation passed through one side, as shown in Figs. 4 and 5, the picture drawn on the other side (revolving at a distance from the axis)

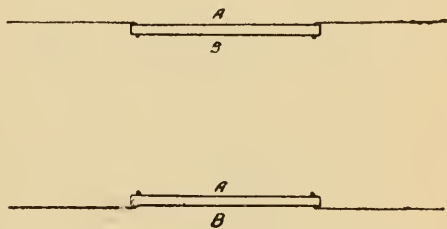

FIGS. 4 &amp; 5.

would come nearer to the eye (situated either at A or B) than that through which the axis passed. One object would thus appear to stand in front of the other, giving an appearance of relief which would convert the usual form into a *Stereo-Thaumatrope*. This apparatus was designed by Claudet to demonstrate rapid alternate convergent and divergent action of the optical axes, but discussion of the questionable accuracy of his conclusions is quite foreign to the subject of

this book, and finds its proper place in a stereoscopic treatise.

It is indeed strange that a toy which in the earlier years of the present generation could be bought six on a halfpenny card should have cost seven-and-sixpence at the date of its inception, and should have tempted the Royal Institution to enter commercial life; but stranger still is the thought of that shilling, carelessly spun seventy years ago, being the first step in the long series of persistent vision apparatus whose latest developments achieve results wonderful indeed when not understood, more wonderful still when a just comprehension is formed of the numberless details which are necessary to the effective working of a living picture. However, to return to the year 1826, the date of the publication of the Thaumatrope's description. One stage in this history is here complete; Fitton's instrument set men thinking, and only six years elapsed before the first appliance was introduced for obtaining the illusion of motion.

## CHAPTER II.

### ILLUSION OF MOTION PRODUCED BY SUCCESSIVE VIEWS OF SLIGHTLY VARYING DIAGRAMS.

THE researches which led to further advance in the illusive production of motion were distributed among many scientific men, each to a great degree unaware of the others' work. The starting-point on the theoretical side was probably Dr. Roget's paper published in 1825, on apparent distortion of the spokes of a rotating wheel when seen through a fence (*i.e.*, a series of vertical slots); a subject later investigated by Plateau. The latter, in 1836, invented the Anorthoscope, an instrument which reversed the illusion observed by Roget, and gave a correct image from a distorted original. In this contrivance a back disc bearing a distorted image revolves at a speed four times greater than a front one which is pierced with four radial slots at angular distances of 90 degrees. When in motion this instrument shows four non-distorted images formed from the one distorted original. Rose's Kalotrope (shown in 1856 at the Polytechnic) further modified this action, and caused beautiful symmetrical designs in curved lines to be produced from originals of very commonplace appearance. These instruments, though in their first forms not strictly connected with the illusion of motion, are so beautiful in their action that, depending as they do on persistence of vision, they deserve mention in case any reader cares to "look up" a subject of so interesting a nature. But in the year 1849 Plateau himself suggested a modification of this instrument which produced the illusion of motion in

a most effective manner, and this matter will be referred to somewhat later in its proper sequence.

Probably it was due as much to the invention of the Thaumatrope as to Roget's researches on apparent deformation of the spokes of revolving wheels that attention was directed to the fruitful combined subjects of persistence of vision and rotation of a series of diagrams; for in 1831 we find several writers, including Aimé and Faraday, referring to the fact that when two cogged wheels, with equal number of teeth, revolve at equal speed *in opposite directions*, one in front of the other, the eye, if placed at a distance, perceives a stationary image of one wheel only. (Plateau had made the same observation in 1828.) This illusive stationary wheel merely results from the strong image perceived each time the aspects of the two wheels coincide; the phase when the cogs of one wheel are passing over the spaces in the other forming, so to speak, a blurred background on which the strong stationary image stands out. To illustrate this Faraday constructed

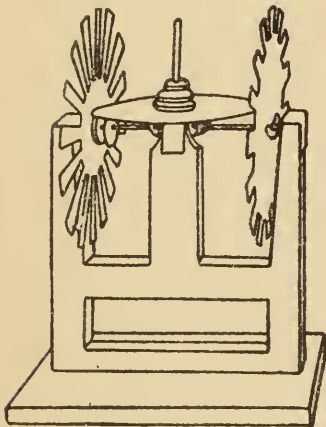

FIG. 6.

a demonstration apparatus called *Faraday's Wheel* (Fig. 6), in which two discs with notched edges were revolved at equal speeds in opposite directions by friction gearing. Faraday and Plateau both investigated the results of revolving two cogged wheels *in the same direction* and looking through the cogs of the front one at the other; in which case also an apparently

stationary wheel was seen, though from a far different cause to that in the first case, as will be seen in the following explanation of the action of a slotted disc.



Faraday also pointed out that *one* wheel gave the same result if revolved in front of a mirror, the image taking the place of the second wheel; the advantage secured being that speed of object and image were bound to be absolutely identical.

It was but a step from this discovery to the employment of a disc pierced with slots to look through and bearing radial lines on its face, *i.e.* the side to be turned towards the mirror. From this experiment strange results followed. When the slots were equal in number to the radii (Fig. 7), the image (as seen through the slots and in the mirror) appeared stationary; when the slots were slightly fewer than the radii, the wheel appeared to travel slowly forward (*i.e.* in the same direction as the real motion of the disc) and to move in the backward direction if the slots outnumbered the radial marks. Now it must be understood that the disc is revolved so rapidly that if the image be viewed directly (*i.e. not through the slots*) the black spokes would be confused into a gray circle.

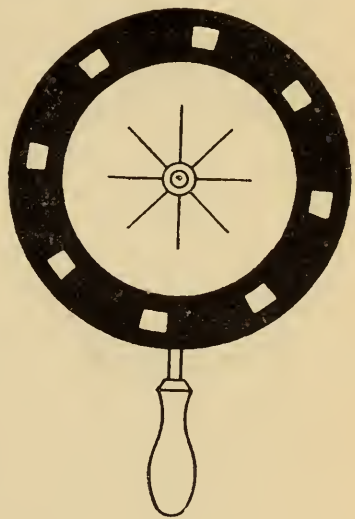

FIG. 7.

Yet when seen through these small openings every individual spoke appears distinctly, a fact which points out the slots as the key to the mystery. The reason is simple. Every time a slot passes the eye an impression is received of the image of the whole face of the disc (as seen in the mirror), and though the whole image is turning rapidly, the slot (if narrow) goes so quickly past the eye that the image has not time to move far enough to give any impression of motion, and therefore

it appears to be standing still. If, now, when the second slot passes before the eye the image presents a precisely similar view to the previous one (and this is the case when radii and slots are equal in number) it is obvious that it will not appear to have moved at all; for we shall have combined *two successive similar images*, by the action of persistence, into *one permanent impression*. If, however, the slots are fewer in number than the spokes (Fig. 8), when the second slot comes before our eye the second spoke instead of falling in the same place as the first, will be seen slightly in advance of that spot, and will thus give the impression that the first

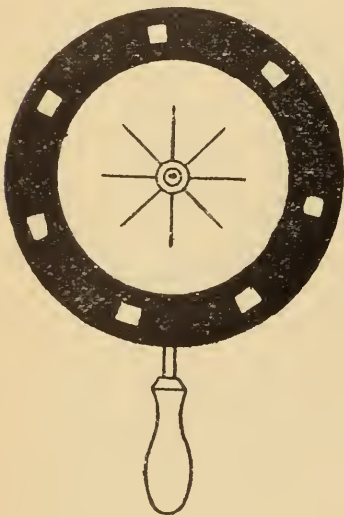

FIG. 8.

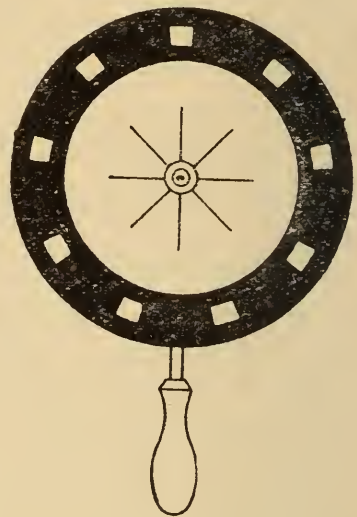

FIG. 9.

spoke has moved forward a little. If, however, the slots are more numerous than the spokes (Fig. 9) we receive our second view a little before the second spoke has arrived at the spot where the first was seen, and we therefore imagine the first spoke to have moved back to that extent. It will now be clear that the whole phenomenon depends on the fact of the moving image being seen for so short a period that it appears to be still; during the time it is *not* seen another image takes

its place, and this substitution is effected so rapidly that the first image persists in the eye until the second one is presented to view; this order of things being repeated with succeeding images so long as the disc is turned.

Suppose, now, instead of a series of *similar* images we have a succession of slightly varying drawings (say of a man) in which while the body agrees in all, yet the arm is in different positions, such as lifted gradually higher and then dropped so that the last of the series nearly agrees with the first. In this case repeated views of the body will all agree, but the arm will be seen, first low down, then gradually rising, then falling and rising again; persistence of vision blending the images, so that the action appears continuous although we really see it in jerks. And here we have the true living picture, capable of improvement no doubt, needing instantaneous photography to confer accuracy, requiring extreme mechanical perfection to secure a sufficient number of pictures in a second and to again combine the same into one continuous scene; but yet, from this point onward, there is little discovery to record, though many ingenious inventions remain to be described. These inventions naturally aimed at one result, but by different methods, and therefore the history of each class of device must be separately traced.

The instrument which has just been referred to as the progenitor of all these species was invented simultaneously by Plateau of Ghent and Stampfer of Vienna; and though their instruments were identical they naturally received different names from their respective originators. Plateau forwarded an example of his *Phenakistoscope* through Quetelet to Faraday in November, 1832, his letter being printed in February, 1833. Stampfer first made his *Stroboscope* in December, 1832, at which date no description had been published

of Plateau's previously constructed Phenakistoscope. As an early instance of confusion of terms it may be mentioned that Snell, writing in 1835, calls the Stroboscope by the name of *Phantascope* or *Kaleidorama*. Müller in 1846 applied this instrument for the demonstration of wave-motion, and Poppe, Savart, and others employed it for the synthesis of other natural motions. One application is shown in Fig 10, where a pendulum

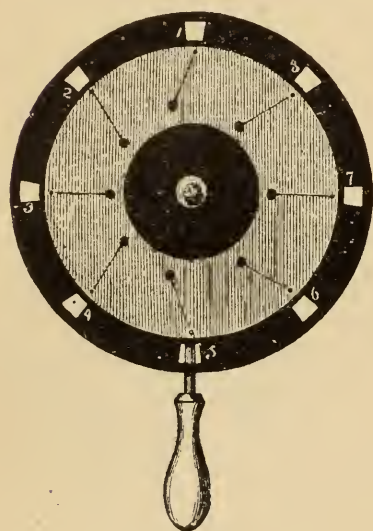

FIG. 10.

appears to swing as the successive stages of that action are momentarily perceived through the slots by means of a mirror. It will be understood that while the slotted disc is of metal the diagrams are drawn on a circular removable card, in order to allow the inspection of varying subjects. One late and very interesting form of this instrument may be mentioned here. Lommel in 1881 suggested that a strong beam of light

might be thrown, from behind, through the disc by means of a lens bringing the beam to a focus in the slot. In this way a powerful illuminating beam was passed through a very narrow opening, and as it again spread out a mirror reflected it on to the surface of the disc, as seen in Fig. 11. When the disc was in rotation the light only fell on the designs in intermittent flashes as each slot allowed the beam of light to pass. The result of interrupting the light in this way, instead of by a slotted disc between the eye and the design, was to render it possible for a whole roomful of people to see



the entire disc at once, whereas with the older arrangement only a single person could view the effect at one time.

The slotted disc was, however, felt to be a great disadvantage by reason of the small amount of light which could reach the eye; an idea of the proportion allowed to pass may be formed from the relative extent of slot and opaque disc, for of course while the latter is before the eye no light is received. Wheatstone endeavoured to overcome this failing by allowing the disc to be viewed on its face instead of in a mirror. By means of a cog and snail motion the disc was kept at rest for a comparatively long period and then rapidly jerked into its next position. The eye was thus impressed with a vigorous image which persisted over the short period of blur caused by the rapid movement, and then received the succeeding stationary image in its full strength.

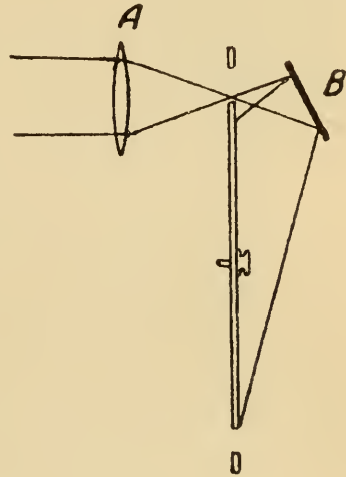

FIG. 11.

This crude apparatus is interesting because some of the most effective of modern machines employ an intermittent motion with so long rest and such rapid travel that a shutter is dispensed with; while one of the most satisfactory forms of apparatus manufactured in France actually takes its name of *Héliocinégraphe* from the very same cog and snail motion employed by Wheatstone forty or fifty years ago. It was subsequently suggested, in order to obviate the use of a mirror, that a slotted disc might be mounted in advance of the diagram but on the same axis, so that they both revolved

in the same direction at the same speed (Fig. 12), and though this form of apparatus did not make its commercial appearance till some-



FIG. 12.

what late in the day, it will be seen from the drawing that the arrangement is exactly equivalent to viewing the back of a slotted disc in a mirror. It, however, opened the way for further improvement by exhibiting clearly the shutter-like nature of the slotted disc.

The first attempts at projection were founded on this type of machine, the design wheel being transparent and light thrown first through it, then through the slots, and finally on to the screen by means of an objective. This was done by Uchatius between 1851 and 1853, but Plateau himself had practically attacked the same problem in 1849 in a modification of his Anorthoscope. It will be remembered that the Anorthoscope produced four non-distorted images from a distorted original. Plateau placed sixteen images in progressive series round the margin of a glass disc, and in front of this, in a reverse direction, revolved, at a four times greater speed, an opaque disc with four slots. The front of the apparatus could be observed by many people at once, and to prevent confusion the parts of the disc showing the non-erect images were screened off. It will be seen that as a slot passed the aperture in the screen one image would be viewed and the light then cut off while the transparent disc turned one-sixteenth of its diameter and the opaque one one-quarter. The next image would then be revealed, by its coincidence with

the slot, in the same position as that in which the previous image was observed.

Plateau seemed very proud of the sensation caused by his first design (drawn to his request, for by this date he was unfortunately stone-blind). It represented a devil blowing up a fire, and the effect was so striking that Plateau was led to further suggestions of a photographic character, which will be referred to in their proper place. It is plain that to render this apparatus available for projection it but required a condenser behind the transparent disc and an objective in front of the opaque one, but Plateau does not appear to have suggested this, and the first application of differentially speeded discs to the purpose of projection-work appears to be the *Lantern Wheel of Life*, an instrument of considerably later date. The Austrian Lieutenant (subsequently General) Franz Uchatius wrote, on the 16th February, 1851, a letter to Prokesch, the head of the Viennese optical house now known by the name of Fritsch. In this letter he refers vaguely to the glories of the Phenakistoscope having been surrendered, and his subsequent papers show that the manufacture of his instruments was entrusted to the above-mentioned firm. The first form attempted was an arrangement exactly similar in principle to Fig. 12, the light being thrown through a transparent design disc on to a screen by means of an objective, the slotted disc acting as a shutter. The loss of light proved to be enormous; figures of greater size than six inches could not be shown; and Uchatius was led to invent, and Prokesch to manufacture, an apparatus of an exceedingly ingenious and interesting nature, which was shown at the Vienna Academy of Sciences in 1853.

In this later form the diagrams were painted on the circumference of a transparent disc, which remained stationary. In front of each design a lens was placed,

the whole circle of lenses being capable of adjustment in order that all the optic axes should cross at the place where the image was formed on the screen. The separate lenses thus all threw their respective diagrams in the same place, the succession of the series being attained by revolving a limelight behind the diagrams, only one of which was thus lit at a time. The interest of this apparatus is great, not only from the fact that the source of light was the only moving part, but also because this appears to be the first suggestion of projecting successive pictures through more than one optical system, a method which at the time of writing is probably the novelty of the day. Instead of moving the illuminant, it would have been simple to have deflected the light by means of a rotating mirror, but

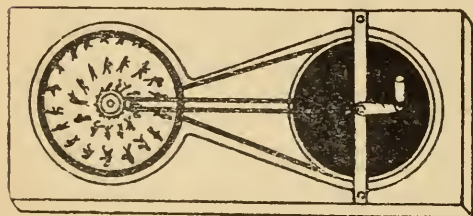
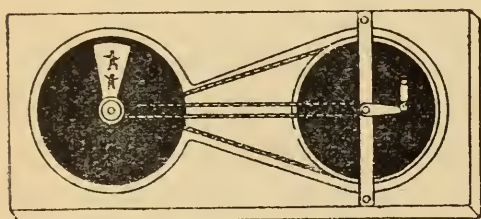

FIGS. 13 & 14.

this multiple form does not appear to have been followed up, and though in any type of slotted machine with continuously moving diagrams the loss of light must have been enormous, yet it was towards the improvement of this type that attention was directed. To secure increase of illumination it was necessary

to show the object for as long as possible, making the change to the next diagram in a very short time. This desire mainly arose because the need for a projecting instrument was strongly felt, and it is certain that no toy attains a great popularity whose use is confined to one individual at a time.



The most effective early device for this purpose was the Ross *Wheel of Life* (Figs. 13 and 14), designed for use in the Optical Lantern, and patented in 1871. The disc bearing the figures is caused to revolve slowly; the opaque disc has one sector removed and travels at such a speed as to make one revolution while the transparent disc moves one stage. Thus in Fig. 13 two figures are seen through the opening in the opaque disc. Its revolution promptly cuts them out of sight, and by the time the opening comes back to the same place the next pair of figures (in slightly different attitudes) are found to occupy the same vertical line. This arrangement is practically a substitution of a one-slot disc for a four-slot one as used by Plateau in the instrument last described. The result of this arrangement is that the lantern screen is full of figures all in motion and in various phases of the same action; but this multiplicity of images is confusing, and attempts were made to show only one figure on the screen at a time. Mr. Beale, of Greenwich, devised a method whereby a face could be shown in motion by means of a series of sixteen pictures illuminated by intermittent flashes. A painting of a human bust was made on a screen, the face being replaced by a hole, behind which could be brought sixteen views of a face in the various stages of a grimace or smile by means of the revolution of a disc on the circumference of which they were painted. A sixteen-holed shutter worked by gearing admitted a flash of light to illuminate the painting for a moment as each face arrived in its proper position, the light being cut off during a quick change to the next expression. By means of an ingenious contrivance which allowed only every alternate opening in the shutter to act, and was adjustable to show first one series of eight and then another, the resultant grimace was varied in a most amusing way. This arrangement,

however, needed a full-sized painting for every effect, and was not of the ordinary magic-lantern nature; the separate pictures not being projected, but only illuminated intermittently.

A single and therefore larger figure than that given by the Wheel of Life was subsequently projected on the screen by the same inventor, whose "Dancing Skeleton" was a great success. A disc was used, rotating in front of a lantern condenser; but this disc, instead of being formed of glass, was of thin sheet metal, the figures of a skeleton in various attitudes being cut out, stencil fashion, round the margin. These necessarily brilliant white figures were projected on the screen in the usual way by an objective, the light being cut off by an interruptor (geared from the axle of the disc) during the period of change. Mr. Beale also constructed this instrument with the stencil figures on a long slip, performing the necessary eclipses by a rising and falling shutter, the whole arrangement being called by him the *Choreutoscope*. An improved form of this device was patented by Hughes (1884), and is applicable to any

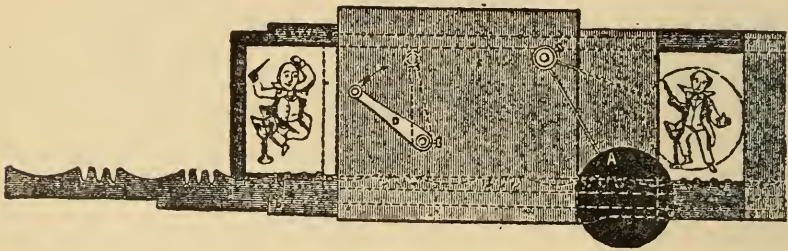

FIG. 15.

ordinary optical lantern. Fig. 15 shows the working parts. Turning the handle revolves a disc, a pin on which raises the shutter and so interrupts the light. Teeth on the disc then come into play, shifting the long slide one stage, and so soon as it comes to rest the shutter drops and exposes the picture. A continuous.

motion of the handle repeats these actions with sufficient rapidity to throw an apparently permanent and moving figure on the screen. A somewhat similar arrangement to Beale's Rotary Choreutoscope was patented in the United States by A. B. Brown in the year 1869 (No. 93,594). This specification is mainly of interest by reason of the construction employed in the intermittent mechanism. It forms a very close approach indeed to the modern cinematograph with Maltese Cross motion; a star-wheel and pin being used to drive the design wheel periodically, while a two-sector shutter is shown geared to eclipse the light during the change of picture. From this point it would be comparatively easy, by describing no more than two machines, to bridge the gap of twenty years which still remains to be traversed ere the first machine of distinctly modern type appears. Mr. Heyl, in the year after Brown's United States patent, exhibited a somewhat similar apparatus, employing photographic images; but consideration of his machine must be deferred until the next chapter, for many elementary forms of apparatus remain to be described before the subject of chronophotography is discussed.

Of the simpler diagram apparatus, however, the phenakistoscopic, or disc-and-slot machines, are practically exhausted, except so far as their principles may recur in some form of photographic device, and it is necessary now to consider the cylindrical apparatus (directly derived from the Phenakistoscope), popularly introduced about 1860, and subsequently called the *Zoëtrope*, *Zootrope*, or *Wheel of Life*, the latter term being a name also applied to a previously described lantern slide (page 19). Desvignes patented the *Zoëtrope*, though not naming it, in 1860. The year 1867, however, saw a patent (No. 64,117) issued in the United States to William E. Lincoln, of Providence,



U.S.A., for the selfsame contrivance under the name of *Zoetrope*, apparently the first use of the word. But this type of slotted machine takes its origin at a date far anterior to those quoted above; in fact, only a little more than a twelvemonth elapsed between the invention of the phenakistoscope (1833) and publication of the following suggestion by W. G. Horner in "The Philosophical Magazine." "The apparatus is merely a hollow cylinder, or a moderately high margin, with apertures at equal distances, and placed cylindrically round the edge of a revolving disk. Any drawings which are made on the interior surface in the intervals of the apertures will be visible through the opposite apertures, and if executed on the same principle of graduated action, will produce the same surprising play of relative motions as the common *magic disk* does when spun before a mirror. But as no necessity exists in this case for bringing the eye near the apparatus, but rather the contrary, and the machine when revolving has all the effect of transparency, the phenomenon may be displayed with full effect to a numerous audience. I have given this instrument the name of *Dædaleum*, as

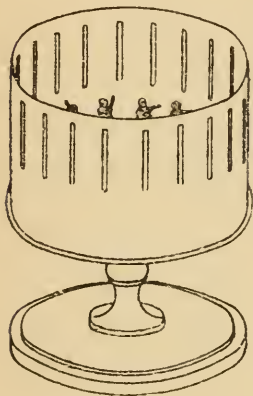

FIG. 16.

imitating the practice which the celebrated artist of antiquity was fabled to have invented, of creating figures of men and animals endued with motion. . . . I have not thought it requisite to give a more particular description of the instrument, having communicated every needful part of the detail, some weeks ago, to a respectable optician of Bristol, Mr. King, jun."

This is an absolutely correct description of the instrument patented by Desvignes twenty-four years later, and known under the name of

the Zoëtropé, an instrument which is still frequently to be seen for sale. The apparatus, in its modern form, is shown in Fig. 16. A band of figures having been placed inside the cylinder, the whole is rotated, and the figures are then seen in motion. The series of figures is such as shown in Fig. 17, which forms a very good example. The bodies, being equal in number to the slots, appear to remain in the same place although legs and arms are in motion. But the number of heads being one less than the slots, the whole series appears to have a slow motion in the reverse direction to that in which the Zoëtropé is turning (*cf.* Fig. 9). The effect is therefore that of a row of dancing figures, perpetually trying on heads and then passing them to their neighbours, who repeat the same antics. The variations between successive figures are better seen in Fig. 18, taken from Bradley's English Specification, dated 1867. As shown in his engravings the modern Zoëtropé is a moderately high cylinder, the slots being placed in the upper part. The first commercial form, however, though the same in principle, differed from this plan in construction. No drawing of Horner's Dædaleum appears to have survived, but the Desvignes' designs are of great interest, as foreshadowing many later inventions, and reference will frequently be made to his various suggestions. Fig. 19 shows his arrangement of the slots *below* the designs, a kind of casing, T, in the interior of the cylinder being fixed in such a manner that it does not revolve, and



FIG. 17.



serves the purpose of limiting the field of vision. By the simple expedient of turning the cylinder on its

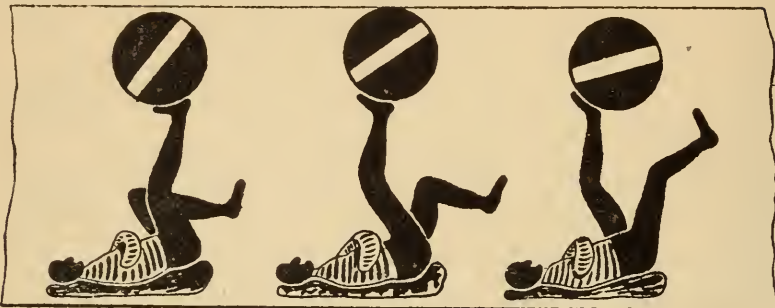

FIG. 18.

side the apparatus was adapted for the exhibition of stereoscopic views, as seen in Fig. 20, a suggestion being made that transparent images might be employed.

With the exception of placing the slots above instead of below the designs, little alteration has been made in this type of instrument up to the present day, attention being mainly directed to the improvement of the figures. Anschütz used this form of

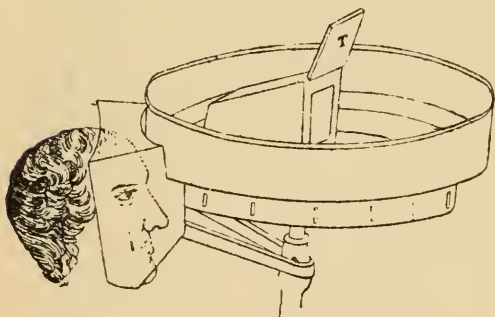

FIG. 19.

apparatus to produce the appearance of motion from series of animal movements photographically obtained. It will be seen that when diagrams are drawn the cycle of movement can be completed in a given number of pictures, and the older form of instrument was therefore provided with a fixed set of slots, the diagrams being prepared

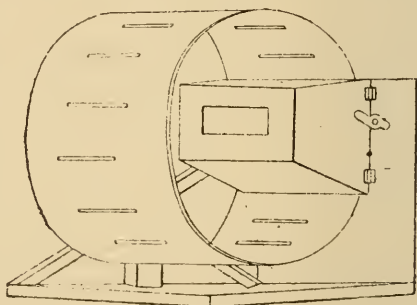

FIG. 20.

with a sufficiency of figures to obtain the desired result. It is very different in the photography of moving animals. In taking these, six, eight, ten, or more pictures may be necessary before the same attitude re-occurs; and this, of course, is absolutely necessary to enable the last picture to run on to the first and give an endless repetition of the same movement. Anschütz was thus obliged to form his Zoëtrope (called by him the *Tachyscope*) as a very shallow cylinder, into which could be inserted a long strip bent round to form the walls. This strip bore the required number of images to complete a cycle of movements, and was pierced with the number of slots necessary to give a correct effect with the number of pictures in the series. Marey not only used photographs but also actual models, on a small scale, of such animals as he desired to show in motion. One of these *Stereo-Zootropes* is still preserved at the Paris Physiological Station, and by the continued observation of successive models in different attitudes the effect is produced of an actual animal running, or bird flying round the interior of the cylinder. In this connection it is interesting to refer again to Desvignes, whose 1860 Specification shows a Zoëtrope employing solid models. By the construction of his apparatus (Fig. 21) the figures were placed on the margin of the cylinder rather than in its interior, but the idea is essentially similar to Marey's.

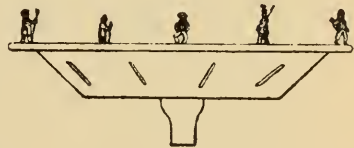

FIG. 21.

Now, one great defect of this, as indeed of every other instrument where the object is in motion while seen through a slit, is distortion. When the object and slit are travelling in the same direction (as in the Phenakistoscope) the object appears elongated, when the reverse is the case (as in the Zoëtrope) it

appears compressed in the direction of its length. Plateau in 1849 had recognised this difficulty, and therefore prepared his diagrams in a form purposely distorted in an opposed sense to the distortion caused by the revolving disc, one distortion thus neutralising the other. This defect led Clerk-Maxwell, in 1869, to propose the substitution of concave lenses for the slots, their focal length being equal to the diameter of the cylinder. The virtual image of the design opposite the lens was thus formed exactly midway between lens and picture, and this spot necessarily coincided with the axis of rotation. That being the case, the successive images were perceived in one and the same spot, and remained stationary during the whole time they were individually exposed to view, the movement of the lens being neutralised by the movement of the real object on the other side of the cylinder. It will be seen that the distortion common to all ordinary types of slotted machines was thus done away with, and at the same time the images appeared more brilliant—a wide lens being substituted for a narrow slot. Maxwell used this device for combining series of diagrams of many physical phenomena (such

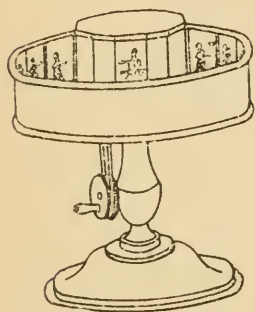

FIG. 22.

as smoke-rings, etc.), in order to show the resultant movement, but the apparatus does not seem to have come into general use.

In the year 1877, however, Reynaud patented a contrivance which attained almost instant popularity under the name of the *Praxinoscope* (Fig. 22). In this instrument the pictures are not directly viewed, but are seen in a mirror, the picture under observation thus being the one nearest the observer instead of that on the opposite side of the cylinder.

It will be seen that the pictures are arranged on a slip placed round the interior of a drum much more shallow than that of the Zoëtrope, and the centre of the cylinder is occupied by a set of mirrors, equal in number to the diagrams, and arranged in polygonal form, the said polygon having a diameter half that of the cylinder. Now, as the picture is a quarter diameter in front of the mirror, its image will appear the same distance behind, exactly on the axis of rotation, the one immovable spot in the whole apparatus. A reference to

Fig. 23 will make the action clear. O is the centre of rotation; A, B, E are two mirrors, and C, D, F the two pictures opposite them. When a picture is in the position S', S, the mirror T', T directly faces the eye, and the image is perceived as if it were at D''', C''', its vertical central line coinciding with the axis of rotation.

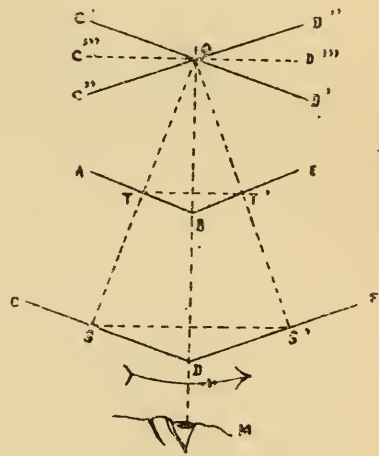

FIG. 23.

It will also be seen that a picture at C, D forms its image at D', C', and a picture at D, F forms its image at D'', C''. In all these cases the central lines of the various images agree, and manifestly they will not appear to shift their position as a whole on the change from one attitude to another. Further, when the apparatus is in the stage shown by heavy lines (that is to say, with the eye looking between the pictures on to the junction line of two mirrors) half of one image will be seen in one glass and half in the other, thus making up a complete image from the combined halves; the appearance given when in action being that of a series of plain glasses passing between an



immovable image and the eye. Here, then, there is no interruption of the light, and the brilliancy of the image is so much the greater, while its stationary position obviates that distortion which forms so great a disadvantage in slotted machines. Reynaud suggested an adaptation for stereoscopic purposes (Fig. 24), but this does not seem to have been carried out.

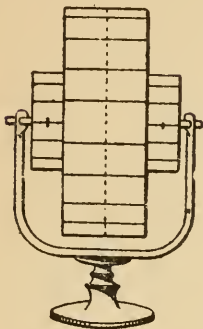

FIG. 24.

Several ingenious additions to this instrument were, however, subsequently made by the same inventor. One, shown in Fig. 25, and called the *Praxinoscope Theatre*, was designed to show a moving figure on a stage. The praxinoscope was screwed into position in the bottom portion of a box, through the lid of which (standing at right angles) an inspection opening was provided. Between this opening and the praxinoscope a sheet of glass, bearing a painted proscenium, was held at a slight angle, the opening of the stage being left clear. On the interior of the lid changeable pictures of scenery could be placed, and were seen reflected in the glass as if they were really in position behind the stage-front. At the same time the moving figures in the praxinoscope (strongly illuminated and drawn on a black background) were seen *through* the transparent mirror, and thus appeared to be in motion on a stage provided with scenery. This result was also obtained in another manner, which permitted a large number of observers to see the effect at once. A kind of double magic-lantern

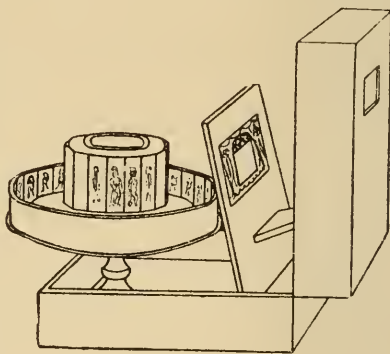

FIG. 25.



(Fig. 26) was used, one member of which threw some scene on the screen in the ordinary way, while the other projected a beam of light through pictures on a transparent praxinoscope drum. On leaving the pictures this light was reflected from the specially angled central mirrors through a lens on to the screen, where it formed an image of the moving figure superposed on the scenery thrown by the other objective. This apparatus

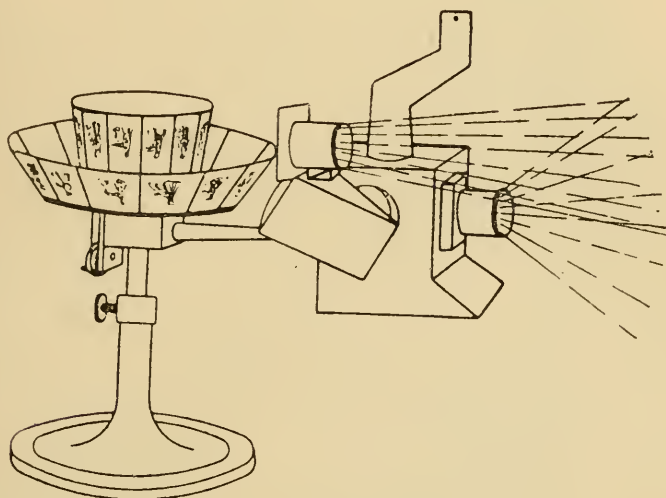

FIG. 26.

was called the *Projection Praxinoscope*, or *Praxinoscope Theatre*.

In 1889 M. Reynaud patented another form of instrument, which permitted the employment of much longer series of pictures. In the previous form the length of the series was limited by the size of the drum. It will be seen by Fig. 27 that the subsequent method permitted a long band to be wound from one reel to another, passing over a skeleton drum on its way. The principle of projection was the same as in the earlier instrument, the permanent scene being thrown by a lantern, L; while another source of light, L', projected a beam through the picture on to the central drum (of the usual

praxinoscope type) from which it was reflected, the mirror M again diverting the light through the objective O. Another mirror changed the direction of the rays and threw the moving picture on the screen. An endless band permitted the use of a comparatively long repeating series, while the length of a non-repeating scene was only limited by the size of the spools and

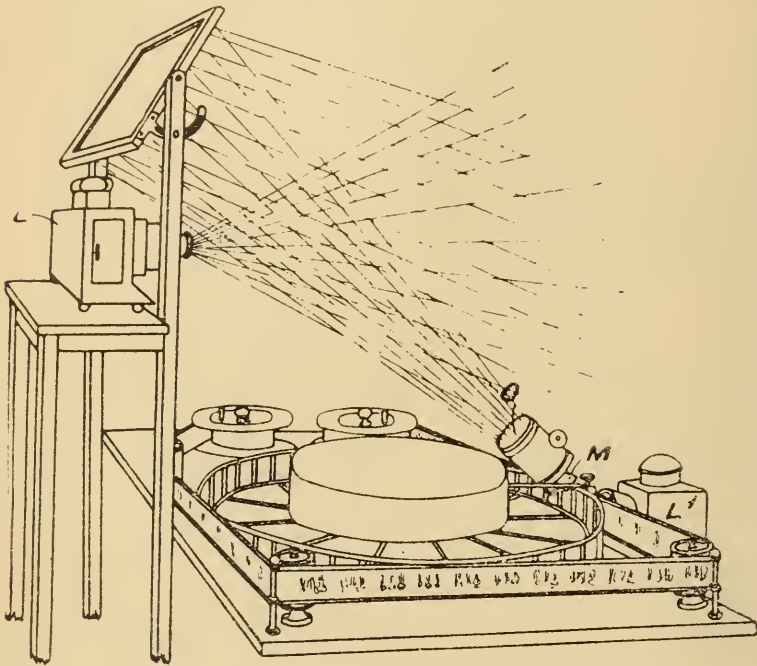

FIG. 27.

the cost of preparing so large a series of pictures. Under the name, firstly of the *Praxinoscope Projection Theatre* or *Optical Theatre*, and subsequently under that of the *Theatriaxinoscope*, this apparatus appeared—in fact still remains—on the Paris boulevards. A serious disadvantage of this form of Praxinoscope must be referred to. The band is necessarily vertical, the objective sloping. This militates against the sharpness of the projected pictures, while the light being reflected from the drum, and again diverted by two more mirrors, all tends to degrade the clearness of the final image on

the screen. But even with these imperfections this arrangement marks the culminating point in the development of the Praxinoscope type, another form of which instrument devised by the same inventor, deserves mention from its extreme simplicity. It was called *La Toupée-fantoché* or *Marionette-top*, and, as seen in Fig. 28, consisted of four mirrors arranged as a pyramid and surmounted by an interchangeable card bearing four designs. The whole was placed on a spindle, and, when rotated, gave a moving image on exactly the same principles as those governing the more elaborate devices previously described. Although this type of instrument has not been further developed, it is worthy of notice that

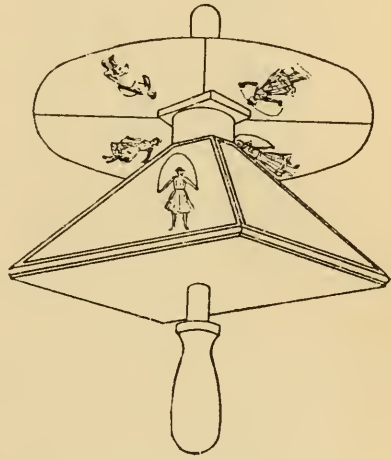

FIG 28.

during the year 1897 two patents at least were applied for having as their central feature a mirror which by its movement rendered the continuously moving picture optically stationary. But in the use of one mirror its slow movement must be followed by a quick return in order to register with the succeeding view; and this quick return, though it saves strain on the film, is yet optically equivalent to a rapid removal of the picture without that movement being covered by a period of darkness. Still, ideas move slowly, and Reynaud's polygonal revolving mirror may yet be applied to the projection of series views of greater complexity than his simple figures afforded.

In following out the cylindrical type of instrument we have come nearly up to date; but there is one other class of device, employing diagrams with a view to

producing illusive motion, a search for the origin of which necessitates a considerable chronological backward movement. Returning to the Thaumatrope, it will be remembered that both sides of the card

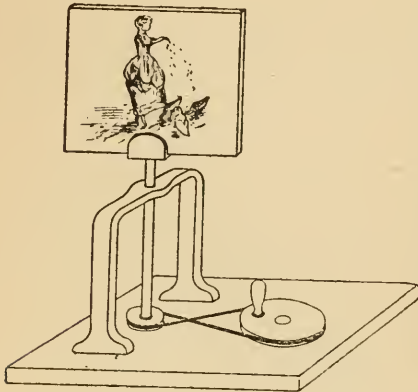

FIG. 29.

are perceived at one and the same time; the card revolves so rapidly that each picture comes back before its image has faded from the eye, and therefore both appear present at once. It will be conceded that the same effect would be produced if the axis of revolution were vertical instead of horizontal, and, in fact, this form of Thaumatrope has been used for demonstration purposes (Fig. 29), while a penny street novelty of June, 1898, shown in Fig. 30, is but a similar instrument rotated by vanes and a blowpipe. Now, it is apparent that if the second picture did not come into view until just as the first was dying out, and remained in sight after the first had entirely faded away, then, under such circumstances, the two views would not be concurrently

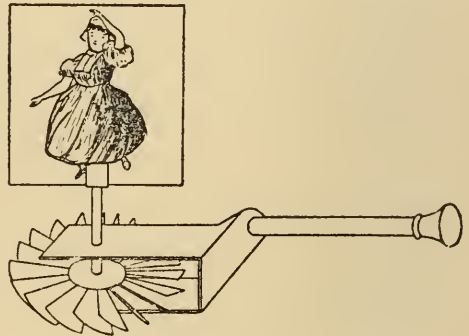

FIG. 30.

perceived, and the first picture would have appeared to have changed into the second. A toy based on this principle was invented by Dr. Richard Pilkington, and is described in "Cassell's Popular Educator"; the date of the invention is not given, and the toy does not appear to have been referred to in any other publication.



As shown in Fig. 31 the *Pedemascope* is fitted with a design giving the effect of jumping, an action from which its name is derived.

A card bearing the two extremes of a movement printed on its two sides was mounted in a wooden holder by means of a longitudinal groove, and the holder was rapidly twirled between finger and thumb, backward and forward, through a half-revolution, by means of

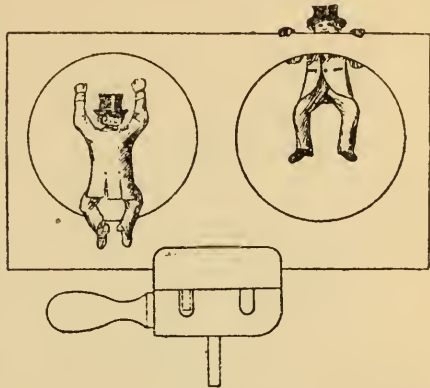

FIG. 31.

an axial pin projecting through a handle. Stops were arranged on this latter to prevent the card exceeding the necessary half-turn, and the apparatus may be considered as one of the most simple for exhibiting the illusion of motion.

In 1868 Langlois and Angiers invented and patented a means of rapidly alternating two microscopic views by means of a pushing-piece, the views returning by

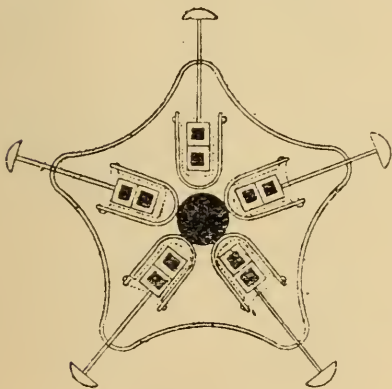

FIG. 32.

the spring of a block of rubber against which they were mounted. This device they named the *Kinéscope*; and a multiple form, designed for a watch-chain charm, is shown in Fig. 32. Their specification also refers to this device as the *Photoscope*.

Another example of this two-diagram class is the ordinary magic-lantern *Slipping-Slide*. One glass bears a figure with, for example, his legs in duplicate, one set being raised and the other



lowered as seen in Fig. 33, wherein a clown is painted on a black background and over him slides a second glass bearing two black patches so arranged that one



FIG. 33.

of the legs is covered while the other is in full view. By a to-and-fro motion of the slipping glass the two differently posed legs are alternately shown, with the apparent result of a gymnastic performance, which may be varied by the action of a second slipping glass

arranged to alternately cover and uncover the duplicate lower portions of the raised legs, which then appear to work from the knee.

Another toy, shown in Fig. 34, is of a very simple nature. A vertical spindle carries a set of four cards, projecting radially at angles of 90 degrees, the whole set being united and capable of rotation. In the four

angles between the cards four successive positions of the same figure are shown. The set of pictures is rapidly rotated by the cards acting as vanes when blown upon, and it will be seen that one figure is observed when an angle is opposite the eye, while a picture compounded of the left-hand of one design and the right-hand of the next is seen when a card stands

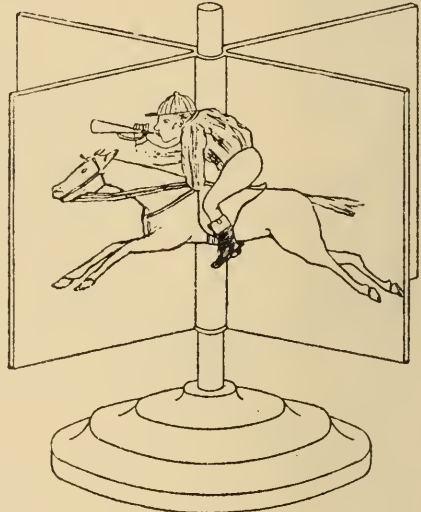

FIG. 34.

“edge-on.” A further development of this was patented in 1895. The cards are independent, and instead of travelling at a fixed rate, are stopped back, but when

released fly over quickly by reason of their spring connection with the central rotating shaft. Though the inventor designed this apparatus as capable of rapid action, it is not, in fact, so employed. It may be seen frequently, working slowly, as a kind of revolving album in photographers' windows.

When a large number of leaves are used, apparatus of this character naturally takes the form of a book in which the bent-back leaves bearing the series of designs are presented to the eye in rapid succession by their escape from under a slowly drawn-back thumb.

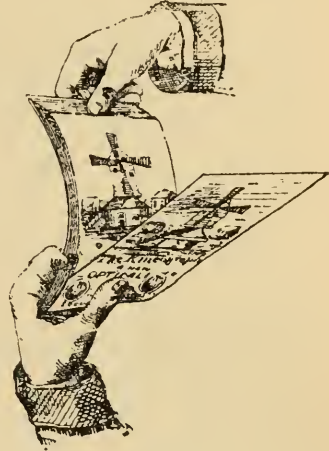

FIG. 35.

The first suggestion of this kind appears to be due to Linnett, who, in 1868, patented his *Kineograph* (Fig. 35). He also suggested the use of mechanical appliances for turning over the leaves, but showed no such arrangement. The book idea (patented again in 1886) had a considerable revival of popularity in 1897 (in which year



FIG. 36.

another patent was granted for an apparently similar device) under the title of the *Pocket Kinetoscope*, half-tone photographs being employed instead of drawings. Book-form apparatus have also been brought out in France by M. Watilliaux under the name of *Folioscope*. A kind of clip was patented in 1896 (No. 20,136) as a substitute for the thumb, and as a means of providing more regular action.

A suggestion by Casler provides for the cards being mounted radially on a wooden holder

instead of being bound in close contact (Fig. 36), and a bent wire lever bears on the upper portion of the cards in order to gradually release them as it passes over. The most perfect, and at the same time most

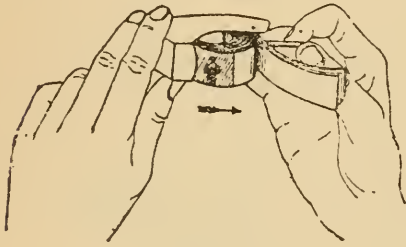

FIG. 37.

compact apparatus in book form is Short's *Filoscope*. The book is bound in a metal clip pivoted in a metal casing, and may be revolved by pressure on an attached lever as seen in Fig. 37. The

leaves are released in regular succession, and fly over rapidly on their escape from the edge of the case, the latter being so formed that the cards when not in use possess a concave curve on their face. By this means their resiliency is preserved and their rapid motion when released is increased. The form assumed by the leaves when the apparatus is closed is shown in

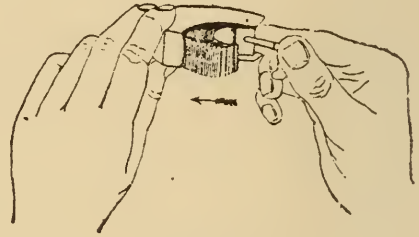

FIG. 38.

Fig. 38. The views are small half-tone prints on the end of comparatively long leaves, the increased length of the leaf serving to rapidly remove each picture to

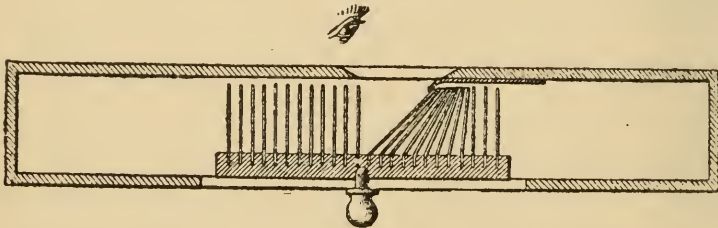

FIG. 39.

a considerable distance from the following one, thus affording a very clear view.

A variation of this book-form type is Casler's *Mutoscope*, which consists of a receptacle having an



opening in its face, under which a set of cards are passed, these being arranged in a series on a flat plate. This plate can be slid along the interior of the receptacle by means of a handle passing through a slot, as seen in Fig. 39, and each card is held back by a stop in order to allow it to be inspected. When the edge of the card is drawn over the stop, the whole rapidly flies past the opening into its normal position, leaving the next picture in full view. Another form of this apparatus is shown in Fig. 40, where the cards are seen mounted on a band in such a manner that one only projects from the top of the casing at a time. The whole series may be pulled over at any desired speed by means of a ring shown at bottom, the

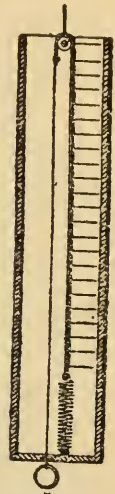

FIG. 40.

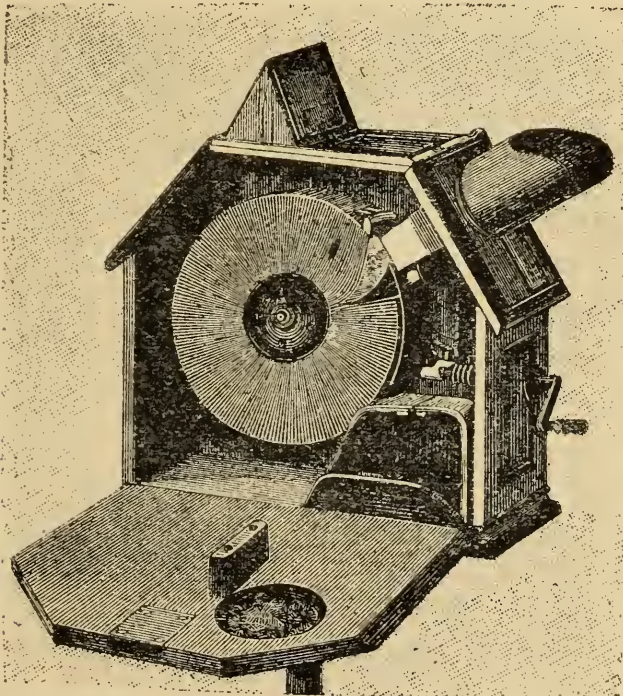

FIG. 41.

band of views being returned by the action of an opposed spring.

A more compact arrangement, and one permitting continuous repetition of a series, is that in which the pictures are mounted on a revolving axle. Fig. 41 is a view of an instrument invented by the same man and called by the same name as the preceding apparatus. A series of cards sufficiently numerous to permit the representation of a continuous scene is mounted radially from an axle. These cards bear photographic enlargements 6 by 4 inches, and the whole may be rotated at any desired speed by means of a handle. Each picture is arrested momentarily by a stop, thus allowing the picture to be distinctly seen, and

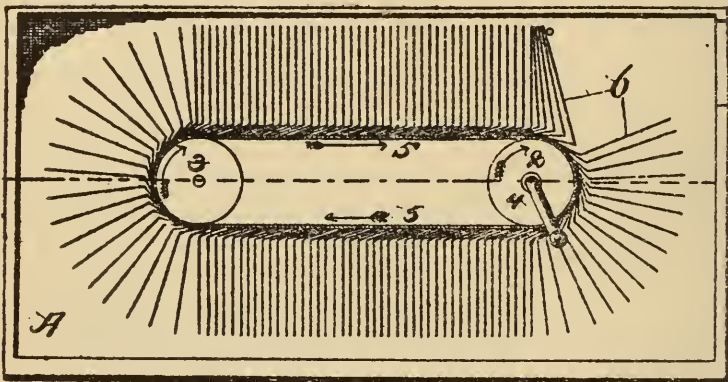

FIG. 42.

then permitting it to fly into its normal radial position as the rotation of the axle sets its edge free. The patent (No. 14,439 of 1895) provides that a longer series may be mounted in helix on the axle, which then must be so arranged that it moves slowly sideways. A subsequent patent suggests the interposition of resilient leaves between the picture cards in order to increase and preserve their spring, and the same end may be attained by the method of mounting shown in Fig. 42. It will be seen that the form of card adopted carries the picture at a tangent, and it therefore flies over rapidly without requiring resiliency, a property not always



possessed by those materials best fitted for printing on, and which is at the best somewhat difficult to maintain in apparatus in constant use. A large number of these Mutoscopes, worked on a coin-freed principle, formed one of the features of the Photographic Exhibition at the Crystal Palace in May, 1898. Messrs. Lumière's *Kinora* (Figs. 43 and 44) is very similar in principle, but varies in a few details, mainly directed towards the important matter of resiliency. The pictures are

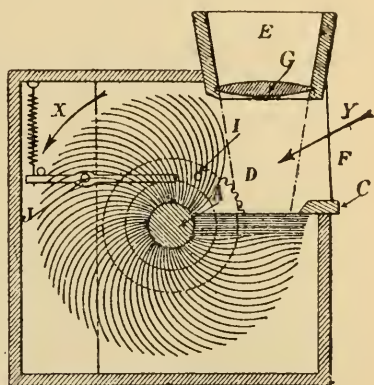

FIG. 43.

mounted on flexible supports, blackened on the back to obviate reflection of stray light, and these supports possess a curved form. The cylinder is rotated by a clockwork motor, H, so as to bring the concave sides of the pictures towards the inspection lens inserted through the top of the casing. A stop, C, arrests the pictures before they reach the lens, to the axis of which they are held at right angles, the curve in the flexible support straightening out to compensate for the rotary movement of the axle. Each

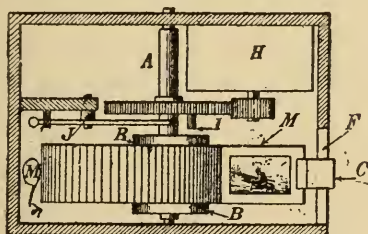

FIG. 44.

picture therefore lies perfectly flat for inspection and then flies rapidly past the lens, returning to its proper radial position and curved form by virtue of its elasticity. The apparatus may also be set in motion by hand, and if more than one scene is depicted in the series an automatic stop, J, is provided. A simple form of this type which has recently made its appearance in the shop windows is

shown in Fig. 45. The cards, tangentially mounted, are held back by a guard, and when released fly into an upright position for inspection, their vertical situation being maintained by a wall against which they rest

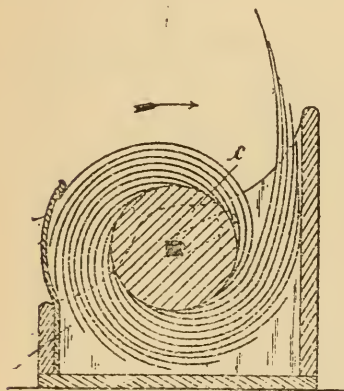

FIG. 45.

until covered by the next picture. Watilliaux' Folioscope is also made in rotary form.

One early application of the Phenakistoscope and Zoëtropé must be referred to, but the idea never brought forth any very practical results, though many minds attempted a solution of the problem. A glance at the Digest of British Patents, and the Bibliography given at the end of this work, will show that in early years great attention was devoted to methods of attaining the simultaneous perception of solidity and motion. Six patents were applied for between 1853 and 1860, all having this object in view, and other methods than those therein described were suggested in various periodicals. With but one exception no new principle was involved, the only suggestions being either that the edges of two discs should be viewed through ordinary stereoscopic eyepieces (the vision being interrupted by passing slots on an independent disc) or else that the two views should be mounted side by side inside a horizontally revolving cylinder slotted in the usual way, an arrangement merely equivalent to a Zoëtropé working on its side, as was shown in Fig. 20. The exception referred to is the principle of allowing only one eye to perceive one view at one time, a slightly different design being presented to the other eye just previously to the first being cut off. Claudet, in making this suggestion in 1853, was

thus endeavouring to meet the same difficulty which faces present-day constructors—namely, interruption of light sensation. It will be seen the difference was that he endeavoured to present a continuous yet progressive image to the brain by means of images impressed alternately on the two eyes and overlapping in point of time; while at the present day there appears to be a tendency towards some method of projecting one

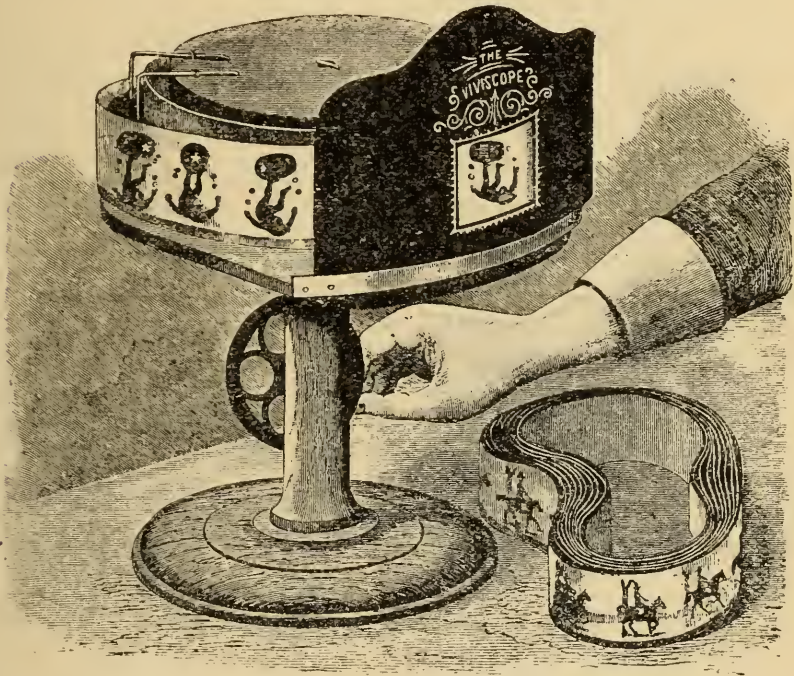

FIG. 46.

picture on the screen from one lantern before the previous view is shut off in the other, thus presenting a continuous picture equally to both eyes.

Two other methods of changing the picture stand by themselves. The first is the *Viviscope*, Fig. 46, in which a band bearing a series of diagrams is in tight contact with a large cylinder except where a small interposed roller bears it off. This small roller travels round under the band, which remains stationary while



in contact with the large cylinder. Each time, however, that the small roller passes any point the band returns to contact with the large cylinder in advance of its previous position. The diameter of the roller is so proportioned that the length of this advance is equal to the distance necessary for the substitution of the next picture. A reference to Patent 2,623 of 1890 will conclude the description of these more or less primitive diagram forms of apparatus. It is a method of substituting one picture for another by means of sectional change over all its surface instead of displacing it as a whole, and the methods suggested are ingenious, although the device apparently has not had a commercial career. The first stage of the History of Living Pictures is now at an end ; the early short-cycle devices have been described, and though some of them have in their development attained a considerable degree of progress, yet without photographic aid it is most probable that they would not have reached so high a degree of efficiency. Thus, the final evolution-stage of the Living Picture commences with the rise of Chrono-Photography, and this subject must next be pursued.



## CHAPTER III.

### CHRONO-PHOTOGRAPHY AND THE PRACTICAL DEVELOPMENT OF THE LIVING PICTURE.

IT has been repeatedly mentioned in the previous chapter that diagrams were unsatisfactory elements from which to build up the illusion of action, and the reason is not far to seek. The numerous attitudes through which a man or animal passes when in active motion are not perceived by the eye; they succeed one another so rapidly that only a general impression of the whole motion is conveyed to the mind; and this general impression, though perhaps satisfactory (from an artistic point of view) when shown in a single picture, cannot be expected to afford sufficient grounds for the preparation of an analytical series of diagrams representing the successive phases of a motion which is only perceived as a whole. It was early known that a moving object momentarily illuminated appeared to be motionless, and, in fact, this was easily deduced from the action of the Phenakistoscope. For instance, in 1850, Tyndall demonstrated the successive phases of a water jet's motion by the expedient of illuminating it with an electric spark, and Fox-Talbot, in 1851, suggested the production of instantaneous photographs by lighting the object in the same manner. This portion of his patent he afterwards disclaimed, but it forms an appropriate starting-point from which to pursue the History of Chrono-photography, inasmuch as, in principle, it is a matter of indifference whether a momentary impression is made on a sensitive surface through the illumination of the object for a very short period, or

whether the permanently illuminated object is only permitted to throw its image on the plate for an equally limited space of time.

But, in its early days, the science of Photography did not provide its devotees with the means of securing an image in a sufficiently short time—a rapid exposure might be made, but no surface of adequate sensibility was available; so, though Photography was employed very early in the production of images for the Phenakistoscope, yet the only advantage secured was an accuracy of outline not to be obtained by hand. Plateau, in 1849, suggested the employment of photography for obtaining a series of pictures (preferably stereoscopic) which should be absolutely correct in outline, but he only foresaw a series of prepared *models* as the originals of his views; the length of exposure necessary excluded other ideas. This accuracy of outline, in some instances, was all that was required. When Desvignes, in 1860, obtained a series of views destined to show a steam-engine in action the process was simple and the result certain. Each element of the engine necessarily followed a predetermined and invariable path, and consequently it was only requisite to place the engine in successive positions of one fly-wheel revolution in order to obtain a series of photographs which, when combined in the Zoëtrope, undoubtedly gave an accurate representation of the engine's usual motion. Still, it was in no sense a reconstruction of a previously existing action of the machine. The separate views were not obtained during the engine's motion, and their accuracy was due entirely to the certainty with which the object could be placed in a series of positions known on mechanical grounds to be those assumed by it when in action.

This certainty could not be secured when living creatures were the subjects, and they could only be

posed in a series of attitudes such as, by supposition (generally erroneous), they would assume in the course of the desired movement. Confirmation of this view is afforded by Mr. Wenham's letter of 1895, in which he relates an amusing story of a series of posed photographs obtained in 1852. The photographs themselves gave no cause for complaint, but when combined by means of the phenakistoscope the subject, who had been using a pestle and mortar, declared that "he never worked like *that!*" The first suggestion of Chronophotography appears to be contained in Du Mont's patent of the year 1861. Therein he says: "Nowadays, photographers are enabled to reproduce on surfaces of great sensibility to the light what they have termed instantaneous images; they photograph a moving object, such as a running horse, etc., but have never thought of obtaining but a single image of the same object, and did not even wish to reproduce several successive ones, or the successive phases produced by motion." Several arrangements were suggested by him, in all of which a shutter was geared to expose the plates when they were perpendicular to the axis of the lens. The sensitive surfaces succeeded each other at regular intervals, being placed either on a prismatic drum, sliding frame, or dropped in series from an upper chamber into a lower one; the latter arrangement, according to the drawings, being almost identical with a very common method of plate-changing employed in present-day hand cameras. Edwards, in 1867, suggested the taking of successive separate pictures on one plate. Ducos du Hauron took a French patent (No. 61,976) in 1864 for "an apparatus for the photographic reproduction of any scene whatever, with all the changes which it has undergone during a specified time." This patent, though issued, was not printed, owing to non-payment of fees; but if the manuscript still exists in

Paris, it would be of great interest to ascertain the methods proposed.

It is well to devote some attention to the years 1869 and 1870; that is to say, the period immediately

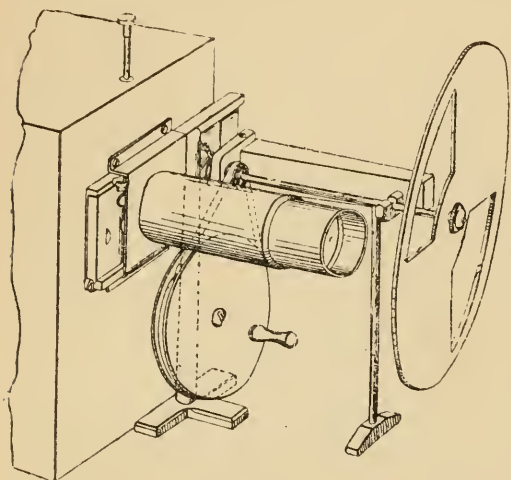

FIG. 47.

preceding the first attempts in chronophotography. Two forms of apparatus, casually quoted on page 21, give a very clear idea of the stage of progress then attained; and they are the more interesting inasmuch as the instrument intended for use with drawn designs shows a greater approximation to modern machines than does the one which employed photographs. Brown's apparatus, shown in Figs. 47 and 48, depended on non-photographic images, of which a series was painted on a polygonal glass plate, P, and dropped into a holder somewhat similar to a magic-lantern slide. A gear-wheel, shown in Fig. 48, served to rotate the designs, and was itself revolved intermittently

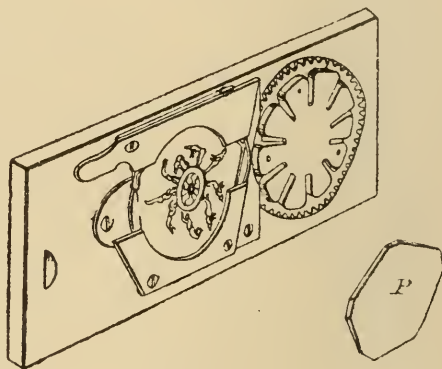

FIG. 48.

by pins contained in the lantern, with which it engaged when the slide was pushed home. These two pins projected from a disc and engaged periodically with a star-wheel, formed in one piece with the gear-wheel



which served to rotate the picture-disc; a motion which in an improved form is still frequently applied to the modern moving band. A two-sector shutter was geared to eclipse the light when either of the two pins caused the design-wheel to move.

So far as can be traced, all photographic efforts were limited to posed subjects up to 1870; the February of which year saw the exhibition of Mr. Heyl's *Phasmatrope* at the Academy of Music in Philadelphia, and, though very successful, this apparatus was based on the synthesis of poses and not of analytical photographs secured from a moving figure. As shown in Fig. 49, the apparatus consisted of a large wheel containing nine divisions, each of which was furnished with two openings for the purpose of carrying transparencies. The whole disc could be revolved, step by step, by means of a ratchet and pawl worked by hand through a reciprocating bar. A shutter, operated by the same means, was so arranged

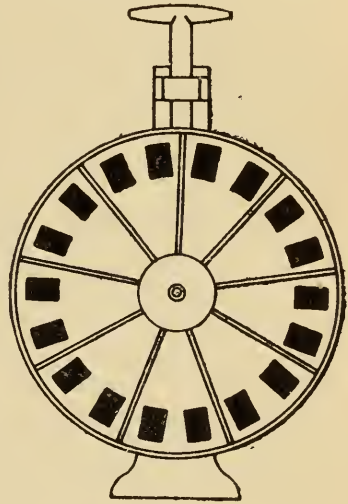

FIG. 49.

as to cover the pictures during the whole period of substitution. The transparencies were prepared from posed subjects, such as the six different positions in a waltz, etc., the figures being three-quarters of an inch in height and projected to life size. The negatives were wet collodion, and that is sufficient reason why posing was necessary; putting the question of time required for exposure on one side, there still remained the difficulty of rapidly substituting a fresh sensitive surface for the one just exposed, and this difficulty could not be fully overcome until the introduction of

dry plates or, better still, films. But advances were nevertheless made, for the rise of chrono-photography afforded opportunity to work out mechanical details for obtaining rapid successive exposures, though the resulting views were not intended for subsequent recombination into motion.

It was in the same year (1870) that Marey commenced his researches on the analysis of motion, and the advance in sensibility of photo-surfaces has lent continual aid from that time onward. Marey in France and Muybridge in America soon entered into communication; the latter started work in 1872, their common object being the discovery of the successive attitudes which collectively make up a given motion, though they worked by somewhat different methods. Marey confined himself from the first to the method of casting his series of momentary exposures on one plate by means of one lens, while Muybridge adopted an opposed course. Some consideration is necessary as to the results involved by these modes of proceeding. Both methods had their respective advantages as regards Chrono-photography pure and simple, but one was limited in its development, the other contained the vital elements of the modern living-picture machine. Briefly stated, Muybridge's plan was to take successive views of an object as it passed in front of a series of cameras; Marey obtained a series of pictures by repeated exposures with one lens. Although Muybridge started work at a somewhat later date than Marey, he devoted greater attention to his subject, and it will be more convenient to first discuss his plan and all the battery forms of apparatus because they have not successfully emerged from the "struggle for existence"—as regards the modern living picture they have died out, though still of great service in pure Chrono-photography.

In the year 1877 Muybridge, for the purpose of

investigating animal motion, laid out a course, similar to a running-path, one side being bounded by a white background so as to obtain silhouette figures. Along the other side was ranged a series of cameras, the shutters of which were released by electro-magnets, set in action by the moving object itself by means of strings placed across the path, as seen in Fig. 50. This device allowed large pictures to be taken, every one representing the object as it appeared in front of the lens by which the photograph was secured; but it was absolutely necessary not only that the members of the object should be in motion, but also that the object itself should move along the path.

Still, this method was adopted by Anschütz of Lissa, in Prussia, with magnificent results, and series of photo-

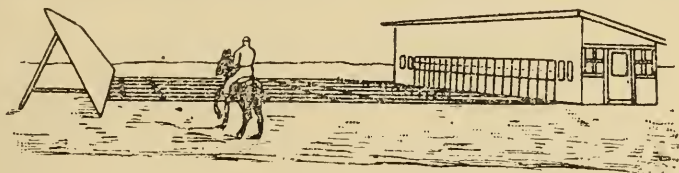

FIG. 50.

graphs so obtained by him met with a ready sale when printed on bands appropriately slotted for use as a Tachyscope (see page 25). Much of his success was due to the employment of an improved form of shutter, very similar to the present focal-plane pattern with adjustable opening. Not only were his photographs prepared in this manner for inspection, but in the year 1889 he brought out his so-called *Electrical Tachyscope*, though there was no point of similarity between this instrument and the Tachyscope proper. As will be seen by the illustration (Fig. 51), transparent photographs were arranged in series round the margin of a disc contained in an inner room and revolved before an opening equal in area to one design. Both the inner

chamber and that containing the audience were darkened, and as each picture came behind the aperture a pin on the disc operated an electric current, thus causing a spirally wound Geissler tube (placed at the back of the picture) to light-up momentarily, the

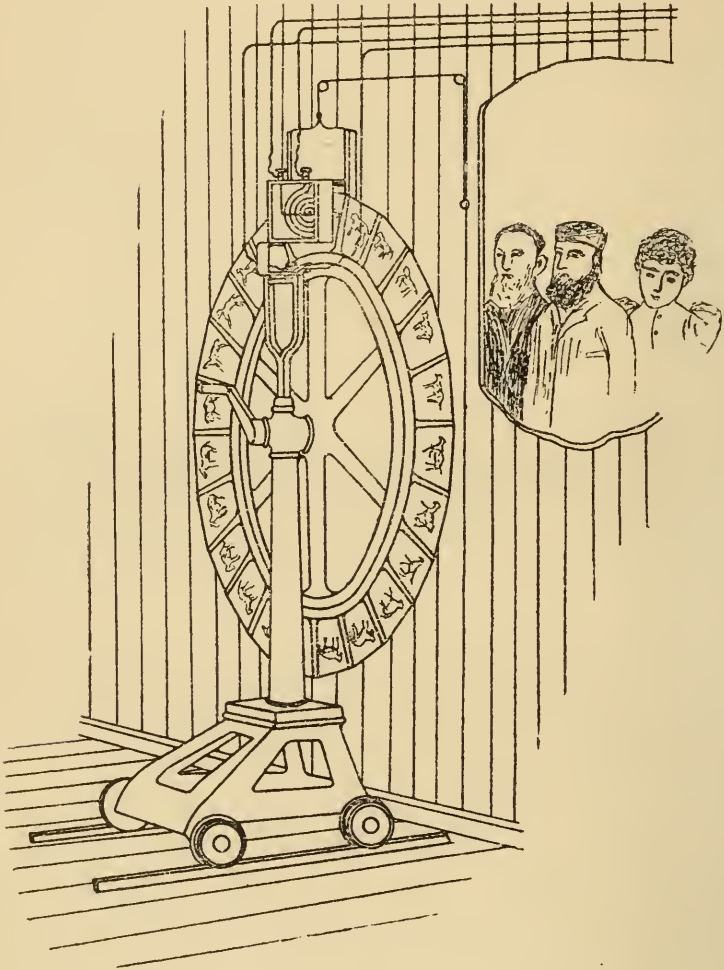

FIG. 51.

successive pictures being seen by the light of the repeated flashes. The disc-form of this apparatus was exhibited in 1889, but in 1892 it was patented with the additional suggestion that a strip of photographs might be used, a suggestion put in practice shortly afterwards



by the introduction of coin-freed or "penny-in-the-slot" apparatus (called the *Electric Wonder*) for viewing living pictures in this and other countries. This appears to have been the first practical and public development of Desvignes' suggestion, in 1860, to use an electric spark to render each picture "visible at its proper time and place." Nevertheless, it must not be forgotten that Donisthorpe, in 1876 and 1878, suggested his so-called *Kinesigraph*, the feature of which was intermittent illumination of a series of views in strip form by similar means to those just described, while the same expedient was one of the first adopted by Edison when conducting the experiments which resulted in the well-known Kinetoscope. About the same time Muybridge had perfected a projection apparatus, called the *Zoö-praxiscope*, which he exhibited at the Royal Institution in 1889. His silhouette pictures were placed round the margin of a fifteen-inch glass disc revolved between a condenser and projecting lens. Immediately in front of the glass disc a zinc one, pierced with one slot, revolved in an opposite direction at such a speed that the slot passed each time a picture came into position. The demonstration was very successful, some photographs not of silhouette nature also being projected.

But as regards the securing of the pictures themselves the necessity of the object having a progressive movement as it passed the long line of separate cameras, as before explained, limited the choice of subjects greatly, and about the year 1887 attention appeared to be generally directed to concentrating all these lenses within a space which might be approximately considered as a single point of view, and so render possible the recording of successive attitudes of a figure which remained in one place; the background therefore no longer needing to be an absolutely plain surface as was the case when successive attitudes were photographed

with a change of local position. Le Prince, working on this principle, in 1888 approached the modern type very closely in appearance, but in appearance only. As will be seen from Fig. 52, he employed a battery

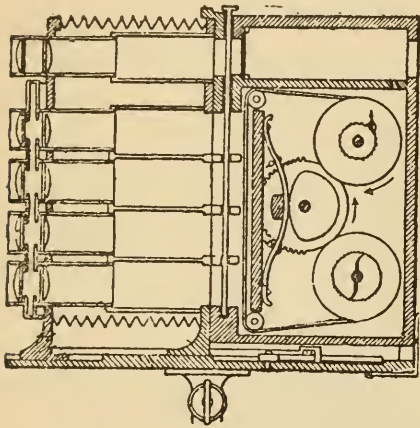

FIG. 52.

of sixteen lenses acting on two sensitive bands, wound from one pair of rollers to another, the two films being side by side. The eight lenses facing one film were released in rapid succession, somewhat overlapping in point of time; the other series of eight lenses were then discharged, during which time the first film was moved

on ready to receive another eight pictures; each film being clamped by a cam-actuated frame during exposure. These exposures were made overlapping in point of time; that is to say, one lens was always opened before the preceding one was shut-off, and when used for projection, as in Fig. 53, this same principle was followed, and therefore no period of darkness occurred between the respective separate pictures. The complicated

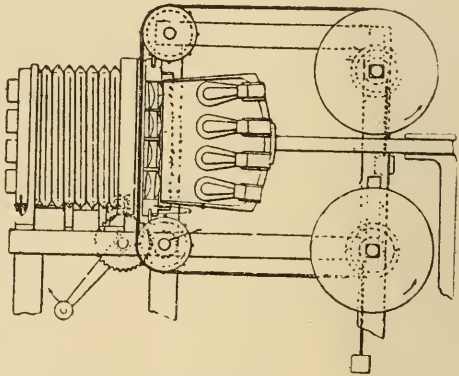

FIG. 53.

nature of the shutter mechanism is shown in Fig. 54, the individual shutters being set in action by partially toothed wheels, rotated in common, but acting at different times by reason of the varying position of

their teeth. At the first glance this combination of serial exposure, intermittently moving film, and clamping-frame appears to be the first machine of the modern type. But consideration will show that Le Prince's apparatus was founded on absolutely different principles to those in vogue at the present time, although some resemblance may be seen to types now suggested, and it may be that future machines may follow some of this inventor's devices. The modern apparatus takes a series of pictures, by means of one

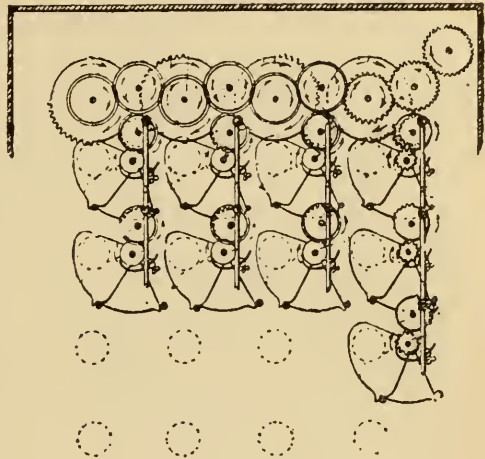

FIG. 54.

lens (or at least from one point of view), on one film moved between the exposures. Le Prince used many lenses and moved his film during the time that neither it nor the lenses facing it were in use, although

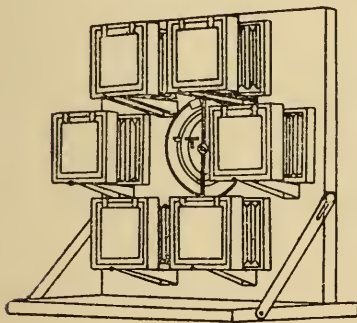

FIG. 55.

exposure was going on by means of other lenses on another film. Practically, his apparatus was a duplicate arrangement of the battery type, and, further, the great difference in position between the lenses at opposed corners must have given rise to varying aspects of foreground objects, thus inducing a false

motion of the same on the screen.

Londe meanwhile had entered the field. He had, in conjunction with Colonel (now General) Sébert, constructed a compound apparatus composed of six

independent cameras arranged in circle as shown in Fig. 55. The six lenses of these cameras were furnished with a series of shutters, naturally arranged in circle, and each composed of two members.

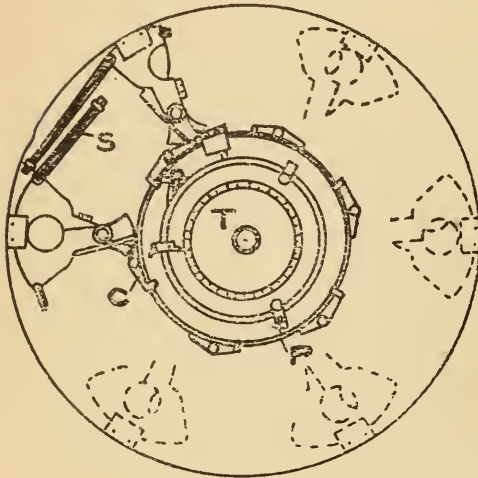

FIG. 56.

and each composed of two members. The motive power was supplied by springs (S, Fig. 56), and each shutter had two projecting catches, C, one of which is shown in the drawing, the other being situated underneath. A centre disc, T, rotated when released, and was furnished with two projecting

stops, one of which opened the shutter by pressure on the catch C, while the other closed it. The latter stop P was adjustable for the purpose of varying the exposure by increasing the distance between the two stops. This apparatus was used by Colonel Sébert for the study of projectile motion.

The latest development of the battery type for securing a limited series of views is that employed at the Salpêtrière for the analysis of abnormal motions, such as epileptic fits, St. Vitus' dance, etc. Twelve lenses are employed, and the shutters released by electro-magnets (Fig. 57).

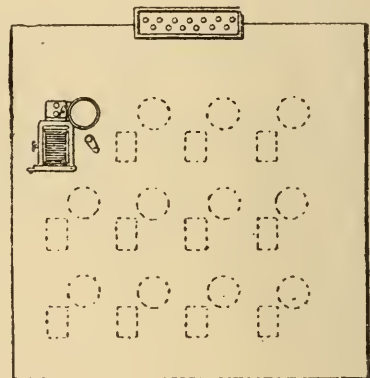

FIG. 57.

The great point of the apparatus is an electrical controller, by which the period allowed to elapse between two exposures



is capable of regulation within wide limits. The series of twelve views can thus be completed in  $1\frac{1}{5}$  seconds or extended over minutes. This, as previously mentioned, is the final example of the battery for taking a limited number of pictures, and was itself three years later in date than the pioneer machine by Greene and Evans, similar in character to those of the present day, which have in nearly all instances followed its arrangement at least in general principles, though the form has been simplified and improved.

The multiple-type having shown itself as adapted solely to the purposes of Chrono-photography, and being without capability of adaptation in the direction of obtaining long series, there remains simply the description of the single-lens system of Chrono-photography. This method, instituted by Marey, was represented in its first stages solely by instruments devoted to the analysis of motion; by slow stages and gradual improvement extending over a quarter of a century it developed the modern living picture apparatus as we now know it. The earliest attempt in Chrono-photography was hardly worthy of the name, yet it pointed the road to the true method of single-lens working. In the year 1865 Messrs. Onimus and Martin exposed the bared heart of a living animal before an opened lens for the purpose of photographing it while in motion. With the low degree of sensibility then obtaining among photo-surfaces the exposure naturally extended over one or more pulsations of the heart, but as a pause takes place at each extreme of the heart's beat, the outlines of these positions were better defined than the space between, and a record was therefore obtained of the maximum and minimum limits of a pulsation. Clearly it was only necessary to secure outlines of several intermediate positions in order that the experiment should attain the character of

Chrono-photography, properly so-called. It will be seen that a photograph of a man lifting his arm would (if the exposure lasted during the whole movement) result in a blur, but if a number of separate exposures were made in the same time, a series of overlapping images, equal in number to the exposures, would occupy the place of the one-exposure blur, and the outlines of these images would in addition form a perfect record of the successive positions of the arm.

The apparatus necessary for this species of Chrono-photography (*i.e.* on a fixed plate) is simple in the extreme. It is only required that a slotted shutter should be revolved before the plate, Fig. 58, in order that successive images may be formed; and these images will be separated in proportion to the movement of the object. This method is all-sufficient for the *analysis* of motion, but the results have anything but a popular aspect; the different images frequently consist in nothing but lines and dots

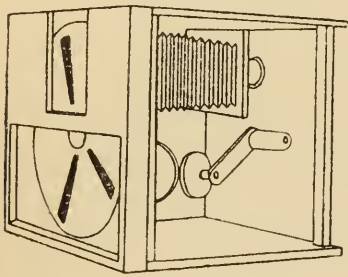

FIG. 58.

representing rods and beads attached to a black-robed subject, who when fully equipped appears to be under the hands of a surgeon rather than those of a photographer. Much work was done on these lines, indeed has been continued up to the present day; but such pictures, valuable as they are for the physiological information they impart, are in no sense suited for the reconstitution of the movement of which they form the elements, and much time elapsed before attempts were made to secure separate and distinct photographs of the phases of a given motion. Had a flexible surface been available, no doubt progress would soon have been made; indeed, the necessity of separating the images was felt and a

longer plate, shifting between each exposure, employed. Another method of separating the images was to interpose a revolving mirror between lens and object. This arrangement is interesting from the fact that it has recently been suggested to use the same device in a reverse manner, causing it to project separated pictures on to one place on the screen, while the original arrangement gave separated pictures on the plate from an original which remained in one place. It cannot be postulated too emphatically that, even at this early date, nothing was required but a flexible and transparent film, capable of receiving an emulsion of increased sensitiveness, in order that the modern living picture might spring into existence; but twenty years were fated to elapse before these necessities were placed at the disposal of the photographic world. Therefore nothing was available except glass plates, and these were naturally used in circular form in order that as long a series as possible might be secured.

In the year 1874, however, an opportunity occurred of photographing a very brilliantly lit object of great interest; and a desire on the part of M. Janssen to obtain a chronographic photo-record of the Transit of Venus across the sun's disc caused him to invent his *Photographic Revolver* and successfully employ it in the far-off regions of Japan. This instrument was placed under cover as shown in Fig. 59, and when in use was directed on a heliostat, which served to keep the image stationary by neutralising the sun's apparent motion. With it forty-eight images were taken around the edge of a circular plate in the space of seventy-two seconds,

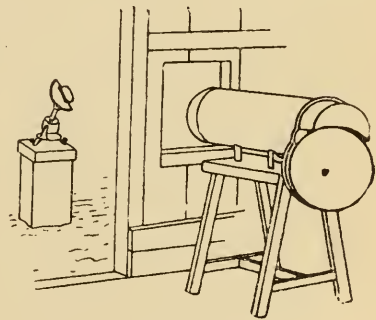

FIG. 59.

and this operation was repeated four times, so as to secure a record of the interior and exterior contact at each margin of the sun's disc. The mechanism by

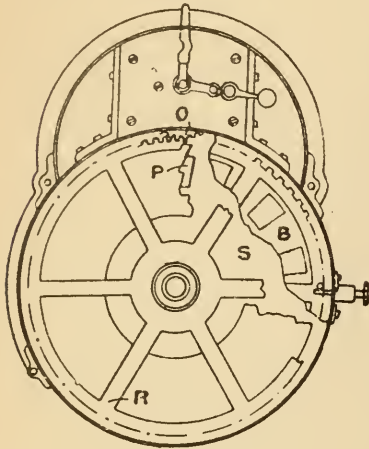

FIG. 60.

which this was effected (shown in Figs. 60 and 61) merits description as being the first practical automatic apparatus for obtaining a chrono-photographic record consisting of separate pictures. A large wheel, R, carried the sensitive plate (making one revolution in seventy-two seconds), and in front of it a disc, B, pierced with twelve openings, made one revolution in eighteen seconds.

Between these two wheels was placed a partition S, pierced with a single opening. When the mechanism was released, the motor-wheels, O, set both the sensitive plate and shutter-disc in motion. The sensitive plate made the forty-eighth part of a revolution and then stopped, this being effected by a Maltese-cross movement. At the moment of its arrest one of the twelve openings in B passed the fixed aperture P, thus making an exposure. The plate moved on, while protected by the opaque part of B between two openings, and then stopped for the next exposure. Some instruments of this kind were taken by an English commission

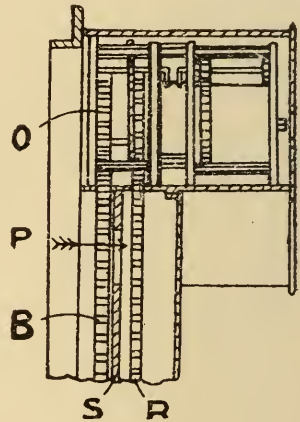

FIG. 61.

to the Andaman Islands in the following year (1875) for the purpose of observing an eclipse of the sun, but the expedition was unsuccessful owing to adverse weather.



Still at best the Photographic Revolver was but an observing instrument, and little could be done in the way of combining the distinct views into one motion; forty-eight separate pictures at the rate of twelve per second would only last the fifteenth part of a minute, and even then would compress the events of seventy-two seconds into that time. To obtain a longer series, Donisthorpe in 1876 further developed Du Mont's idea of rapidly dropping an exposed plate into a lower chamber, so leaving the next free for exposure, and provided a special gearing by which the shutter covered

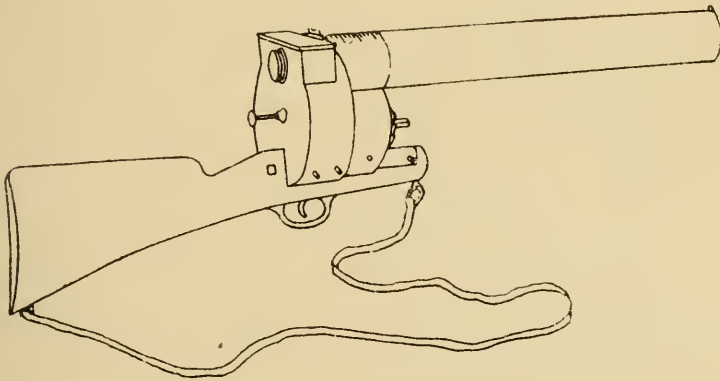

FIG. 62.

the lens during the change. Nevertheless, Janssen's instrument was the model on which Marey founded his *Photographic Gun*, which was of real value for analysing motion in such a way that it could be subsequently re-compounded by means of the Zoëtropé. Its name was well chosen, and is perfectly descriptive of the apparatus shown in Fig. 62. The length of barrel was necessitated by the use of a long-focus lens, which was, of course, absolutely indispensable when photographing a small object at a considerable distance. This barrel was arranged so as to telescope for focussing purposes. The breech contained clock-work mechanism for effecting the series of exposures,

and a glance at Fig. 63 will explain the methods employed. It will be understood that the back cover is removed in order to show the parts. On pressing the trigger a circular shutter with one opening commenced revolving at a predetermined rate. Behind this a disc

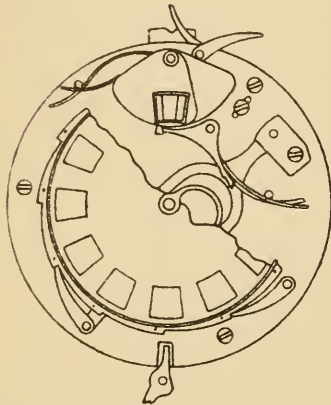

FIG. 63.

(half of which is shown in the drawing) with twelve openings also revolved, the sensitised plate lying behind it and rotating with it by friction. This disc, together with the sensitised surface, was rotated by means of a pawl (shown at the bottom left-hand) on an arm worked by an eccentric, and every time one of the twelve openings, backed by a portion of the sensitised plate, came to rest opposite the lens-

aperture the hole in the shutter passed in front of it, admitting light and making an exposure. It will be understood that during its movement the sensitised plate was protected by the opaque part of the revolving shutter. Marey used this instrument in order to obtain some extremely effective photographs of birds in flight; nevertheless, the apparatus was far from perfect. The defect of this instrument was that twelve images in very few cases gave a complete cycle of movement; when the last picture of the set (say of a bird in flight) was reached, the bird had not arrived at that stage when the wings occupied nearly the same position as in the first picture. But still Marey adhered to the plan of using *one* lens for making successive exposures, and his later improvements followed out that principle.

In 1892 Demeny showed a similar but much improved apparatus at the International Exhibition of Photography. This was of the usual disc form, a rotating

shutter being used the travel of which was far more rapid than that of the sensitised plate; the latter only moving a short distance to its next position while the opaque part of the shutter made nearly a revolution before the single aperture passed the lens. This apparatus was called the *Photophone*, and its construction will be understood from the very similar projecting apparatus, Fig. 64, named the *Phonoscope*, in which the major portion of the shutter is cut away in order to show the picture-disc.

The origin of this name is found in the fact that M. Demeny used this instrument for securing a series of twenty-four photographs of a man during the act of pronouncing some phrase, in order to analyse the lip-motions. The reconstitution of the lip-action was so successful that a deaf-mute was enabled to read the words "Vive la France" from the lips of a photograph.

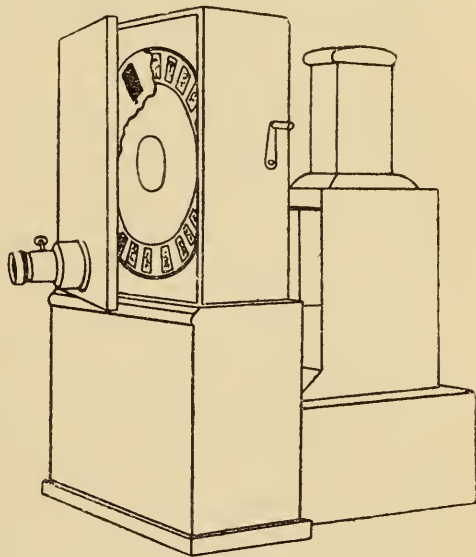

FIG. 64.

The set of pictures being sufficiently long to cover the whole period of utterance, an enthusiastic deaf-mute could pass the day experiencing (it is impossible to say "hearing") the above-mentioned patriotic sentiment. It is worthy of notice that even the intelligent specimen of humanity above referred to was absolutely nonplussed when the handle was turned backward, and the lip-motion consequently reversed. The Photophone was apparently the final example of the disc-form which took its origin in Janssen's Photographic Revolver. This apparatus.

was patented, and in the same specification M. Demeny showed some modifications directed towards obtaining longer series. This form of the apparatus does not appear to have been publicly exhibited, but is sufficiently interesting to merit description. The views

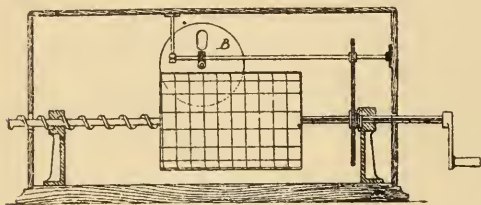

FIG. 65.

were mounted in spiral on a non-transparent drum, the axis of the latter being furnished with a helix which traversed the drum at such a rate as to maintain the spiral set of pictures under

the inspection lens, as seen in Fig. 65. The shutter was not interposed between eye and picture as is usually the case, but was mounted between light and drum. Fig. 66 shows the beam of light passing through the slot in the shutter B, and after undergoing a deviation by the mirror *m*, falling on the drum and thus illuminating the successive pictures by intermittent flashes as the slot in the shutter periodically permits light to pass. A reference to Fig. 11 will demonstrate the relation between Lommel's invention of 1881 and that of Demeny in 1892; the principle being the same although the latter apparatus gave a

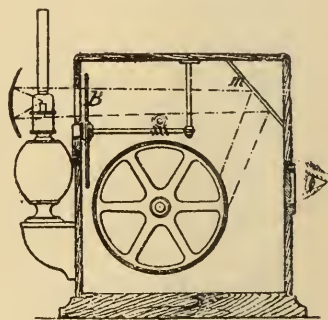

FIG. 66.

longer series and displayed but one image at a time. The specification suggests that a phonograph might be combined with the inspection apparatus—an idea previously set forth by Donisthorpe in 1876 and 1878.

During these later years the extreme rapidity attained by photographic emulsions, together with the possibility of obtaining long lengths of flexible transparent film,



rendered the production of a long series of photographs in rapid succession possible. Many steps leading up to this desirable consummation have been quoted in the past pages, and methods of securing rapid exposures were invented to keep pace with increasing speed of plates; indeed, it may be said that as a general rule it has always been possible to procure a shutter so rapid in its action that it refused to yield a picture, and shutter devices have always been ahead rather than abreast of plate speeds.

The idea of using a band for the purpose of lengthening the series of views is almost as ancient as

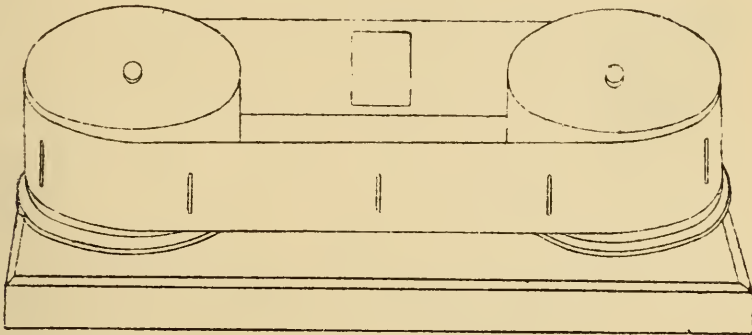

FIG. 67.

the Phenakistoscope itself. In fact, the first published description of the Stroboscope contains a suggestion of this character, Stampfer therein intimating that a long endless band might be passed over two rollers, provided that suitable means were employed in order to interrupt the light at correct intervals of time. And, indeed, this fact was never lost sight of. Desvignes, in 1860, proposed to place his Zoëtropic designs on endless bands (Fig. 67), but in the days of wet-plate photography such an expedient was entirely out of the question so far as *securing* pictures was concerned, and even the early dry-plate, with all the assistance it rendered, lent no substantial aid in this direction.

Thus, in 1876, Donisthorpe proposed to place his Kinesigraph pictures on a band arranged to run off one roller on to another, but only for purposes of inspection; the negatives from which they were printed were obliged to be obtained at a comparatively low speed on plates and the positives actually mounted at accurate intervals. Not until the introduction of celluloid as substitute for glass was it possible to secure a long series of exposures on a suitable strip, and the commercial existence of this eminently suitable support began to bear fruit in the year 1888. Here, as in every other branch of our subject, the first steps were

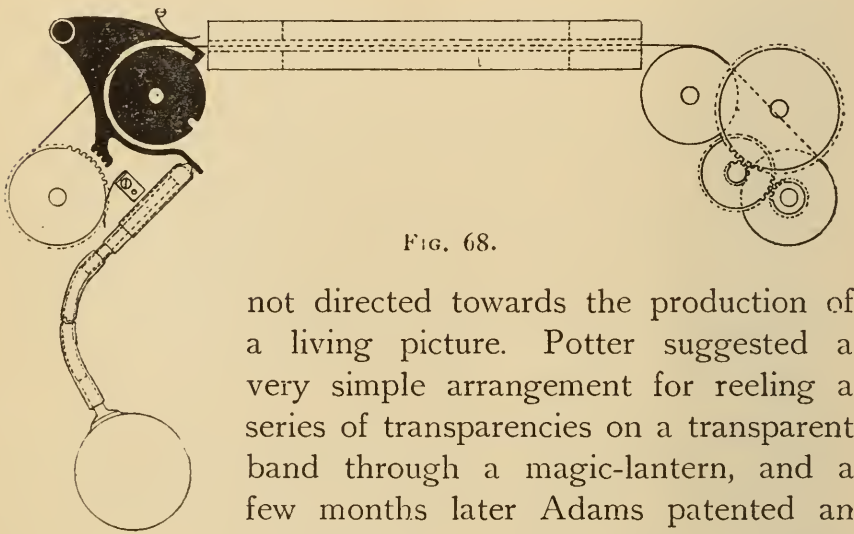

FIG. 68.

not directed towards the production of a living picture. Potter suggested a very simple arrangement for reeling a series of transparencies on a transparent band through a magic-lantern, and a few months later Adams patented an arrangement for the same purpose, which is interesting from the fact that it contains, in a crude form, very similar features to the first workable living picture machine. As seen in Fig. 68, the band was drawn onward by a spring roller, but was normally prevented from moving because it was gripped between a roller and brake-block, both shown black in the illustration. When a pusher came into action the brake-block was raised, as shown in the drawing, until the stud dropped into a slot in the roller, when the

teeth also locked the wheel attached to the spool. This arrangement would certainly have been unsuitable for rapid working, if only on account of strain on the film, but it is interesting as an example of how an idea may be "in the air," for this spring roller, allowed to act intermittently by means of an escapement tooth, was the feature of the apparatus patented in the next year by Messrs. W. Friese-Greene and M. Evans, to whom must be adjudged the honour of having first introduced a practical instrument capable of securing a record of any event and suitable for subsequent reproduction of a moving picture of the past occurrence. Their joint specification was filed on the 21st of June, 1889; on the 25th of February, 1890, an actual instrument was shown before the Bath Photographic Society, and at that date their projection apparatus was in the maker's hands. Their camera was capable of securing three hundred exposures at the rate of ten in each second, though this speed could be increased considerably if required. The construction of this piece of apparatus was most ingenious and so simple that a short description will suffice. The film passed from one spool over a plate, which held it flat for exposure, and then on to a second spool by which it was wound and stored. Both spools were driven at an equal speed from the main-shaft, and thus the film would have passed the exposure opening with a steady and uniform motion had it not been that a roller was interposed between the light-aperture and the receiving spool. This roller contained a spring, continually wound from the main-shaft. The spring would have forced the roller round as fast as it was wound up but that on the roller's edge was placed an escapement tooth which rested against a cam. This cam (itself in continual rotation) stopped the roller from turning, but a gap in its edge allowed the escapement tooth to pass once in

a revolution. When this occurred the roller made one turn and drew down sufficient film to remove the exposed picture and substitute the next portion of the film. While this was stationary and the cam making its next revolution, the winding-up bobbin was storing away the piece of film just pulled down, while the feeding-spool was reeling-off just sufficient to supply the next sudden revolution of the spring roller, the spring of which was at the same time being wound-up. A special shutter was also shown, but it was of comparatively little importance when compared with the arrangement for intermittent film-feeding described above.

Greene was also working about this time, apparently in conjunction with Rudge, on a machine designed to project successive pictures without interrupting the light. The images were placed alternately on the edges of two discs which revolved side by side in front of a single large condenser. The light and condenser could be moved slightly out of the central line so as to illuminate, say, the left-hand picture, and were then shifted so as to light up the next design situated on the right-hand disc. While this was being shown the left-hand disc turned one stage in order to bring the third picture in position. Separate projection lenses were used, one facing each disc. The extent of movement required by the condenser in order to illuminate the images alternately was very small, and furthermore the light was not suddenly cut-off, but died away gradually, thus reducing the flicker. An experimental machine on these principles was shown before the Bath Photographic Society, but there appears to be no record as to any exhibition of the perfected instrument.

As before stated, the honour of prior publicity undoubtedly rests with Messrs. Greene and Evans, but others were working at the same problem, and in



August, 1889, Messrs. Donisthorpe and Crofts filed a specification in which they showed another means for securing a stationary film during the period of exposure or projection. This device was ingenious, the film being in continual process of unrolling from one spool and rolling on the other, and yet the portion in use was kept stationary opposite the lens without any sudden pull to change the portion exposed. The film passed from one spool to another at a continuous speed past the exposure opening, but this movement was periodically neutralised by lifting film, rollers and all, at a speed equal to the downward motion of the film by means of a crank-motion, the whole frame being steadied by rollers (shown black on drawing) running between guides (Fig. 69).

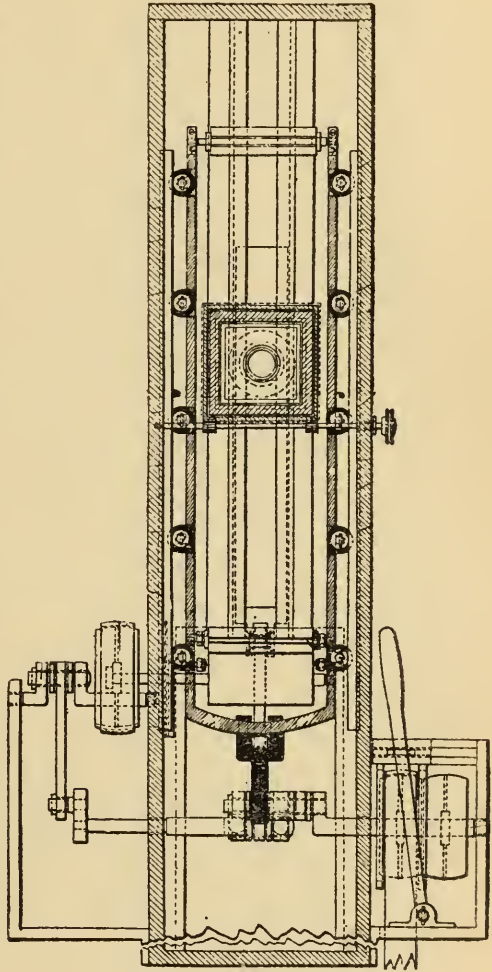

FIG. 69.

Thus a portion of film opposite the lens was continually travelling nearer to the bottom roller, but was also being raised at an equal speed; the same piece of film therefore remained in the same place during exposure. This terminated, the whole frame sank to a sufficient extent to expose the

next section of film, which, though still moving on, was kept in the same position for so long as necessary by a repetition of the raising of the whole mechanism. Though this apparatus is somewhat complicated, the description afforded by the specification is specially interesting as showing the difficulties to be contended with at that date. The inventors purposed obtaining their negatives on strips of sensitised paper. Now paper, even at the present day, imparts some grain to the negative, and this was the case to a greater degree nine years ago. The pictures, therefore, were designed to be prepared on a larger scale than at present—two and a half inches diameter was suggested; while for the band of transparencies the only available material was again paper, rendered partially transparent by vaseline or castor oil. This difficulty was so great that the inventors also suggested that an opaque band might be used and the pictures projected by reflected instead of transmitted light, somewhat on the principle of the Aphengoscope. The large size of the pictures, and consequent large extent of film required to pass in a given time, together with the considerable mass of moving parts, must greatly have hampered the inventors in preparing an effective machine; but, after all, difficulties and even failures, to the philosophic mind, are of almost equal interest with conspicuous successes; they afford equal ground for consideration, and furnish data from which to accurately estimate the relative values of various systems.

This apparatus again points out the one essential needed to complete the modern living picture—a transparent, structureless support. This necessity was furnished in the year 1888 by the introduction of celluloid. On its first appearance this material was not so satisfactory for photographic purposes as it is now, neither could it, at first, be obtained in the

18 positive

requisite ribbon form, and Marey's first instruments for using films were rendered ineffective (except as regards pure chrono-photography) by the limited length of the bands commercially available. Nevertheless, invention and suggestion now began to move at a rapid pace. Early in 1890

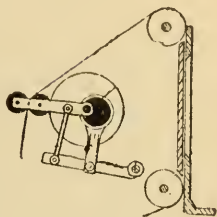

FIG. 70.

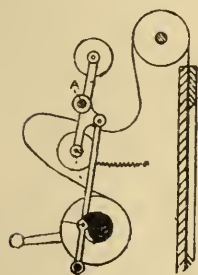

FIG. 71.

Evans suggested several arrangements for moving the film intermittently. The principal form was one in which a friction-roller in continuous rotation was brought into contact with the film periodically for a sufficient time to move it one picture length. This end might, of course, be attained by the use of many mechanical equivalents. Other arrangements shown by him are worthy of illustration as embodying the germs of many modern motions. For instance, two small rollers, shown black in Fig. 70, are kept in continual rotation, and gripping the film between them, draw it onward at a constant speed. But the arm on which these rollers are mounted is drawn backwards and forwards by the black eccentric seen on the right. Consequently, during the time the lens is open the rollers are drawn to the right along the film without moving it though they are rotating all the time; but so soon as the lens is closed the arm moves in the opposite direction, thus drawing the film onward to the extent of the travel of the arm, plus the amount due to the rotating grip of the rollers. Another arrangement has two rollers situated on the ends of a rocking arm mounted

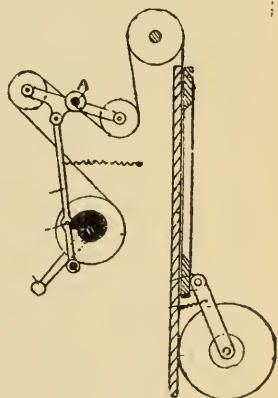

FIG. 72.

on a pivot (A, Figs. 71 and 72. This arm is periodically tilted by a lever worked by the black cam seen at the bottom of the drawings. In Fig. 71 an exposure has just commenced. The film is held steady by a light gripping frame, and the store reel is occupied in rolling-up the slack portion of film. When this is accomplished the cam causes the rocking-arm to tilt, as seen in Fig. 72, thus drawing a fresh portion of film in front of the lens and then, suddenly returning

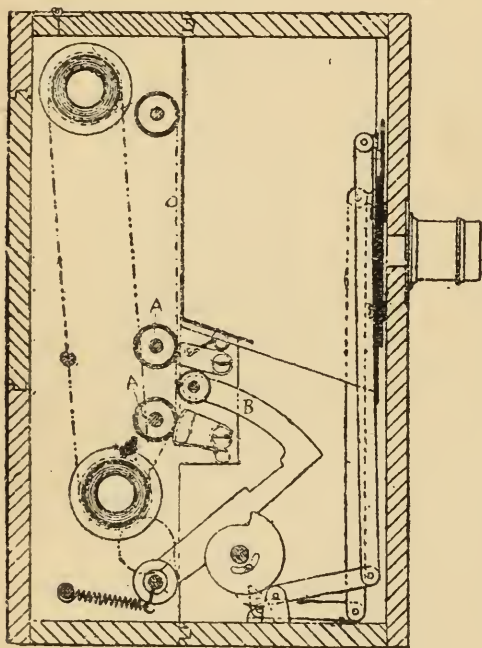

FIG. 73.

to its first position, leaves a double loop of slack to be stored away exactly as seen in the preceding figure. A few days afterward Varley filed a specification showing another means for attaining the same end as that secured by Evans's rocking-arm, namely, causing a loop to be formed in the film by means of intermittent pressure. The film was steadied by the action of two spring-

pawls which gripped it against two rollers (A, Fig. 73). By the revolution of a cam, not shown, an arm, B, was periodically thrown forward against the film, of which a sufficiency was driven back between the two rollers, A, to draw an exact picture-length down. The arm then returned to its first position while the store-reel took up the slack so formed. The cam seen in front works a double shutter by means of levers. It was also suggested that light should be allowed to



act through four holes in a screen, forming marks at the sides of each picture for the purpose of punching holes in exact register.

M. Marey, towards the end of 1890, constructed a chrono-photographic camera in which a band passing from one spool to another was employed. This apparatus had been gradually evolved from one constructed in the year 1888, having a *paper* negative band periodically arrested by an electro-magnetic grip. In 1889 the paper gave place to film, and a zoëtropic instrument combining views so obtained was exhibited at the Paris Exhibition of that year, when M. Marey showed the apparatus to Mr. Edison. In 1890 the mechanical details were finally arranged as shown in

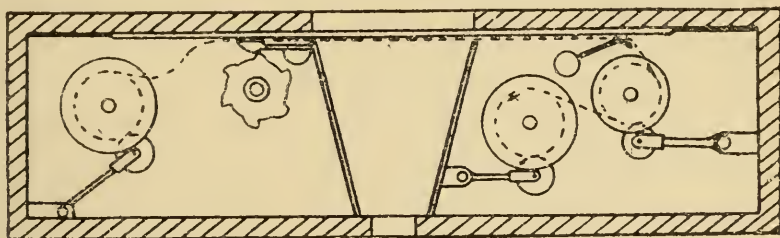

FIG. 74.

Fig. 74. The *Chronophotographe*, or, as it was first called, the *Photochronographe*, was driven by clock-work, and all its parts could (previously to making an exposure) be set in motion without actuating the film. On touching a stud a friction-roller pressed the film against the top right-hand roller (already in motion as stated), which then began to drag the film off the left-hand bobbin, past the exposure opening, and past a spring, as shown by the dotted line. The receiving-bobbin was mounted on a revolving spindle, but could not itself revolve, by reason of the pressure exerted on it by a brake. So soon, however, as the stud pressed the friction-roller against first-mentioned roller this brake was taken off, and the receiving-bobbin, being

free to revolve, took up the film passed on to it. To render the film periodically stationary, a rounded bar was pressed against it at proper intervals of time by means of a star-cam, thus gripping it tightly and preventing its motion. Inasmuch, however, as the motive-roller was continually dragging at the film, the latter would have been torn were it not that the film passed over a weak spring. This straightened out under the pressure exerted by the film, thus shortening its path and feeding the roller with sufficient film to last until the grip was taken off, when the spring returned to its former position and assisted to draw the next section in front of the exposing aperture. M. Marey did not succeed in obtaining very long series of exposures with this apparatus. About forty pictures were taken in whatever period of time seemed desirable, and he complained, in an account given by him of his work, that bands of film longer than four mètres were not obtainable. Still, had he confined his pictures to moderate dimensions, he would doubtless have been more successful from the living picture point of view; the fact of procuring negatives nine centimètres (about  $3\frac{1}{2}$  in.) square was quite sufficient to fill up his band long before an extensive series was obtained. But as Director of the Physiological Station his work lay mainly in the analysis of motion, and the only use made of his early serial pictures was to recombine a phase of motion by means of a modified Zoëtrope in order that the real action of one second might be spread out in point of time to facilitate leisurely inspection, and for this purpose it was necessary to remount the positives at proper intervals, the spacing on the negative band being slightly irregular. About the same time M. Marey constructed a somewhat similar instrument for use with the microscope in order to record the various motions of the lower forms of animal life.

At this point it is difficult to say whether a retrospective view is necessary or not. If first ideas are to be taken into consideration, then Mr. Edison should have been mentioned earlier, but the first intimation of his work in the domain of the Living Picture did not reach England until the 28th of May, 1891, when a somewhat meagre account of his *Kinetoscope* was printed in "The Times," having been received through Dalziel's Agency, while the full description of his invention, filed in the United States 24th August, 1891, was not issued until March 14th, 1893 (No. 493,426), and was never patented in England. The first public exhibition of this instrument seems to have taken place at the Brooklyn Institute on May the 9th, 1893, the first machines in England being shown in Oxford Street in October, 1894. It certainly appears as though Edison might have established a claim to be considered the father of the modern Living Picture (so many forefathers have been mentioned, it is difficult to trace the exact pedigree) had he not been deluded and delayed by affection for his pet child, the Phonograph. It was apparently in 1887 that he first conceived the idea of coupling the reproduction of a past event with the repetition of sounds recorded at the same time. He appears to have spent much time in a fruitless attempt to secure his negatives in a manner analogous to the reproduction of speech on the phonograph—that is to say, in a spiral line round a cylinder similar in every respect to that of the sound-recording instrument which was put into action at the same time. And here it may be well to explain the nomenclature of Mr. Edison's various productions. A *Kinetograph* takes the separate pictures, the *Kinetoscope* recombines them into motion. The prefix of Phono- denotes that a Phonograph is coupled with the instrument, consequently a *Phonokinetograph* records both events and sounds, and the

*Phono-kinetoscope* reproduces them by direct vision. This instrument has also been called the *Kinetophone*. When the *Vitascope* is defined as the same inventor's projection-apparatus the list of Mr. Edison's contributions to the Living Picture vocabulary is complete, though, in view of the statements made by Mr. Jenkins, there is some doubt as to Mr. Edison's connection with the *Vitascope*.

Now to return to facts. Edison's first pictures were absolutely microscopic, a matter which at once gave rise to a dilemma. If small, they needed considerable enlargement in order to be viewed, and this necessitated a sensitive surface which should be practically structureless. Nothing but collodion would meet this requirement, and its low degree of sensitiveness to light rendered it very difficult to obtain an image at all. Increase of aperture in the lenses certainly would meet the difficulty, but only at the expense of that definition which was so essential when subsequent enlargement was required. Therefore this method was abandoned, and larger negatives obtained in spiral on sheets of celluloid wrapped round a cylinder or on the edge of a disc, and at this stage Edison adopted the method of lighting his views momentarily for inspection by means of a Geissler tube, through which a current was passed every time pins (placed on the revolving disc) made the necessary contact. This was the plan adopted in Anschütz' Electrical Tachyscope, exhibited in 1889; but it is apparently impossible to discover at what date Mr. Edison hit upon the same device. He finally settled down to a form of instrument having a one-slot shutter and continuously moving band; the exposure was consequently extremely brief, and the waste of light involved by this arrangement rendered his apparatus as crude in its principles as the first Phenakistoscope, though from



the point of view of mechanical accuracy it was a marvel.

In many of its mechanical details, however, Mr. Edison's perfected Kinetoscope was unique, and a short description of the apparatus, considered as a whole, will serve as a basis for their elucidation. The mechanism was contained in a cabinet furnished with

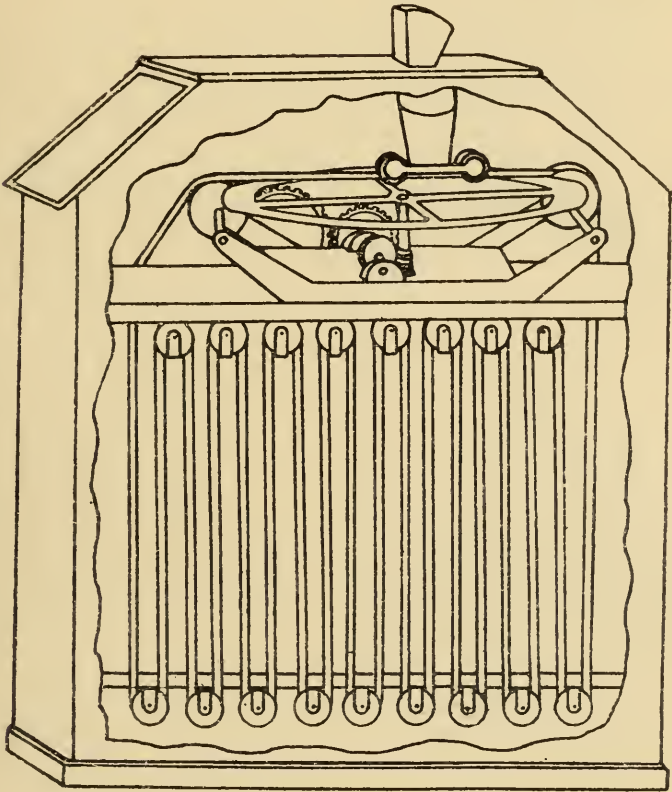

FIG. 75.

an inspection opening at the top, as seen in Fig. 75. This cabinet was divided into three compartments, the one above extending over the whole width of the case and containing the essential mechanism, the other two divisions each occupying one-half of the lower portion. One side, shown in the drawing, contained a spool-bank accommodating an endless film, while the other

side enclosed the motive mechanism, which was naturally electric, that method of driving being well known as Mr. Edison's favourite. The celluloid band was of the now familiar form; that is to say, each margin was perforated with four holes to every picture, though in 1890, when his pictures were smaller, Mr. Edison used a single line of perforations only. This endless perforated band passed from one side of the spool-bank to the other through the upper chamber, being stretched

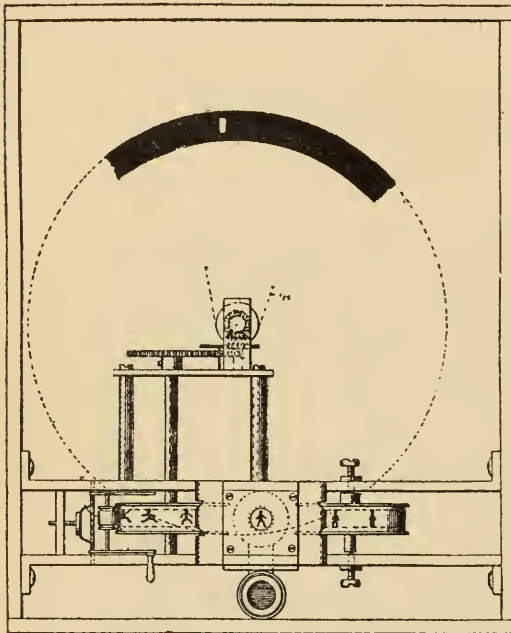

FIG. 76.

over two sprocket-wheels (fitting the perforations), which drove the band past the inspection lens at a constant speed equal to forty-six pictures per second. Below the band, and opposite the inspection opening, an incandescent lamp was situated; the American patent shows a peculiar form of alum-trough placed between lens and film in order to absorb heat, and also a prism arrangement for altering line of sight. As the band was not arrested for the inspection of each picture, some means of providing momentary illumination was necessary, and this was accomplished by a one-slot shutter making forty-six revolutions per second, so as to allow light to pass each time a picture was accurately centred. The mechanical ingenuity displayed in the accomplishment of this method of intermittently illuminating a film continuously moving

at so high a speed is worthy of all praise ; but it must not be overlooked that the *system* itself was faulty, and totally precluded use of the apparatus for projection purposes. A glance at Fig. 76, which shows the shutter and film in plan, will demonstrate the enormous waste of light involved by Mr. Edison's arrangement. The slot was only one degree in width, and therefore only one - three - hundred - and - sixtieth part of the available light was allowed to pass to the eye. Under these circumstances no known source of light would be powerful enough to stand the waste in projection work, while a camera arranged on the same principle would be an impossibility ; an attempt to secure forty-six pictures per second would necessitate exposures of less than the sixteen-thousandth part of a second, a period too brief for the most sensitive emulsion to cope with.

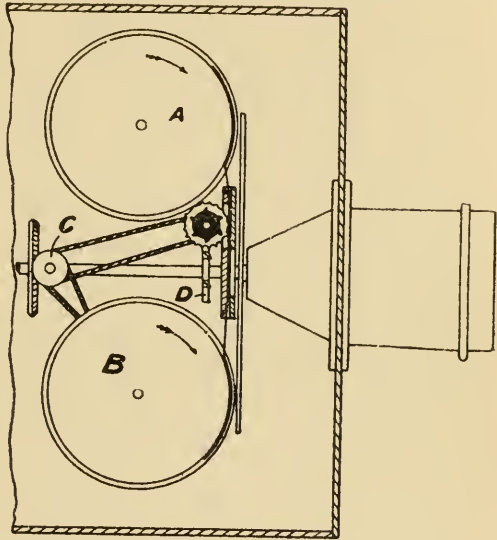

FIG. 77.

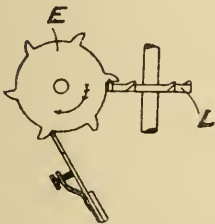

FIG. 78.

An entirely different arrangement was therefore adopted in order to secure negatives in the camera, but little information was allowed to transpire ; and although the patent specification was filed in the United States on August 24th, 1891, the patent itself was not issued until more than six years had passed away. Up to the 31st August, 1897, it was only known, in vague terms, that Mr. Edison.

used some form of intermittent mechanism giving one-tenth movement and nine-tenths rest. The arrangement adopted in U.S. Patent No. 589,168 is now seen to be that shown in Fig. 77, wherein the film passes from spool A to spool B, being drawn along by a sprocket-wheel driven from the pulley C. The film would move continuously were it not that the rotation of the sprocket-wheel is periodically checked by the interaction of two toothed wheels, one (D) situated on the main shaft, and the other (shown black in the illustration) beneath the sprocket-wheel and on the same axle. To save strain, the pulley runs loose when the two wheels are locked together as shown in Fig. 78. The right-hand wheel is just about to allow the other to move one stage, the tooth passing through a slot

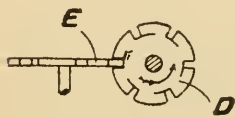

FIG. 79.

(Fig. 79). So soon as this tooth makes its escape the wheel E turns and carries with it the sprocket-wheel, and therefore the band. When a picture-length has passed, the next tooth on E strikes the surface of D, and remains locked until the next slot comes round and permits another tooth to escape.

This machine would not perhaps be of great importance were it a recent invention, but it must be remembered that it was filed six years ago, on the same date as the Kinetoscope specification, and these two documents make mutual cross references to one another. When, therefore, it is seen that the long-concealed document is furnished with comprehensive claims, including the perforated film, views in series from one point of view, and many other equally general ideas, some point is lent to the persistent rumours that Mr. Edison is about to assert his "rights." The invention not having been patented on this side of the Atlantic, the question hardly affects the English



public ; but if rumour speak truly, there are many users of perforated film in the States who naturally have not foreseen that years after acquiring their machines they would have a covering patent flourished in their faces—a patent concealed from public view for six years!

Two projecting machines were at one time on the market under Mr. Edison's name ; but they will be referred to later, neither of them seeming to employ the intermittent motion of an escapement nature which Mr. Edison undoubtedly patented in 1891 and presumably applied to his camera. It however seems feasible that this patented method was abandoned in favour of another ; the wear must have been great, for both wheels were subjected to sudden impact forty-six times per second, and the interval between these impacts was mainly occupied by frictional contact between tooth and checking-surface.

From what has been said respecting the Kinetoscope it will be seen that this instrument was practically identical in principle with Anschütz' Electrical Wonder exhibited at Frankfort in 1891, with the difference that in order to secure momentary illumination of a continuously moving film Edison used a revolving shutter and Anschütz a flashing Geissler tube ; Edison's line of sight was vertical and that of Anschütz horizontal. Furthermore, in 1888 Le Prince suggested the use of perforations and sprockets for feeding his band through the machine ; but in the absence of celluloid this band was metallic, and acted rather as a carrier. Still, Mr. Edison must be credited with the practical introduction of the perforated film, and this system of perforation formed the foundation of a large number of methods for securing accurate registration and intermittent movement. The gauge of perforation which he instituted has, with a few exceptions, been practically

adopted as the standard, and the maker of every machine in present use which utilises perforations for feeding is so far indebted to the "Wizard of the West." Furthermore, though the Kinetoscope was only available (publicly at least) for inspection, and not for projection, Mr. Edison did the world a great service in bringing the matter of Living Pictures into a prominent position; he demonstrated the fact that a suitable transparent flexible band was commercially available, and the encouragement thus given to manufacturers and inventors who saw a possible remunerative field for the exercise of their talents was doubtless largely responsible for the rapid progress towards

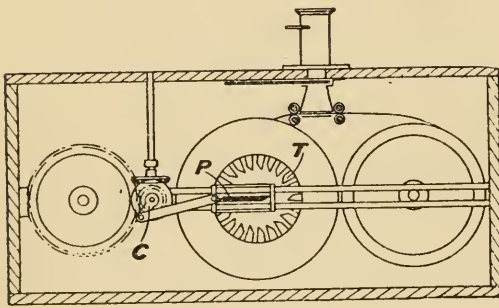

FIG. 80.

of step-by-step motion (Fig. 80). A tappet, P, with inclined faces is drawn to and fro between parallel guides by means of a crank, C, and each time the frame carrying it reaches the top or bottom of its stroke the inclined face of the tappet strikes the inclined face of a tooth, T, thus driving the drum onwards. This forward motion ended, the tappet enters the straight portion between two teeth and so steadies the wheel. On its return journey it leaves this space centred against the slide, and the circle of teeth consisting in an odd number, there is naturally a tooth ready placed for acting on when the tappet reaches the end of its stroke. After the wheel has been steadied by the

effective projection which was made during the next three years.

On September the 24th, 1892, Mayer filed an American specification (No. 525,991), which shows a new form

tappet a slight pressure is maintained by detent-springs to prevent accidental displacement.

In the same year (1892) a suggestion was made in "The Optician and Photographic Trades Review" which, considered from the purely theoretical side, is of considerable interest though the practical difficulties involved are obvious. It was based on a modification of the ordinary panoramic camera, in which, as is well known, the whole camera revolves horizontally about the optical centre of the lens. The image is thrown on a film carried round a curved bearing-surface, a screen confining the action of the lens to a comparatively small angle. When the curved film extends over 180 degrees a half-revolution of the camera forms a picture of one-half the horizon; but if the film is fed from one side and taken up at the other a complete revolution may be accomplished and the whole horizon embraced. Let us suppose this operation completed in one-tenth of a second, and it will be plain that, given a further supply of film, the camera might make another turn, and yet another until the film was exhausted. Now, every time the lens faces any particular object it will photograph it again and again subject to the changes which it has undergone during the revolution of the camera, and if a positive be made and the operation reversed, light being thrown through the film and lens on to a screen (the projector revolving all the time), then the whole horizon may be reproduced in continual process of change on a circular screen. The chief objections to this course are that public audiences are not accustomed to a circular screen, and also that the consumption of film would be enormous; with a two-inch lens about  $6\frac{1}{4}$  inches of film would be used every tenth part of a second, as against  $\frac{3}{4}$  inch at present. Of course, as suggested, a part of the horizon could be screened off and other subjects taken on the

protected portion of the film, but probably the collection made on one ribbon would not be universally acceptable, and the idea, ingenious as it certainly is, cannot be considered as within the range of practical politics.

In June, 1893, M. Marey took a French patent (No. 231,209) for his *Photochronographe*, a slightly

improved form of the apparatus shown on page 71. The arrangement of its several mechanical details rendered the spacing of the individual photographs somewhat irregular, and the views were therefore of comparatively little use for subsequent projection. At a considerably later date M. Marey overcame these difficulties, and his final apparatus will be described in the next chapter.

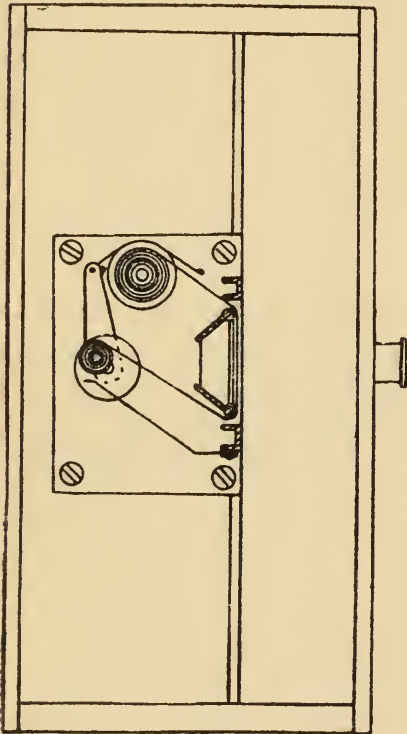

FIG. 81.

Another French patent (No. 233,337) of October in the same year contains the description of M. Demeny's apparatus subse-

quently introduced as the *Chronophotographe d'amateur* or *Biographe*. Fig. 81 shows the principle involved in the invention. The film was reeled from one bobbin to another, being steadied in front of the aperture by a pressure-frame. The lower or taking-up bobbin was, however, mounted eccentrically, and thus on its down-stroke gave a sudden pull to the film, which then remained stationary while the bobbin rose and rolled



up the film previously pulled down. In this crude form the apparatus was only adapted for taking short series; the amount of film rolled up on the lower bobbin naturally increased during working, and therefore varied the amount of film pulled down at each revolution. The error was obviously that of imparting eccentric action to the store-bobbin; had the latter remained independent and the eccentric motion been applied to an intermediate roller the action would have been constant. This fact was soon recognised, and M. Demeny incorporated a new and important modification into his German and English patents applied for only two months later—that is to say, in December, 1893. This development was not added to his French patent until July, 1894, and it is from this patent that Fig. 82 is reproduced. The eccentric motion previously applied to the bobbin was now transferred to an intermediate portion of the mechanism, thus giving an intermittent pull to the film, constant in extent and regular in action. The film,

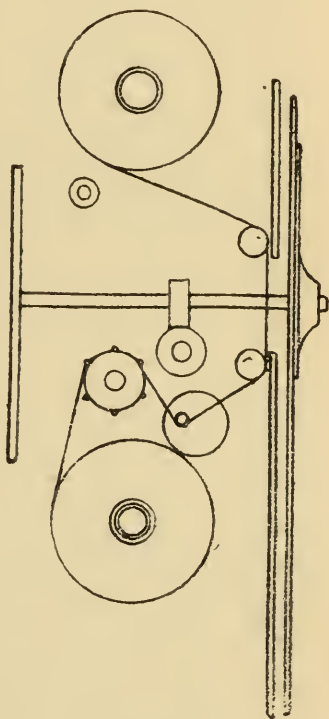

FIG. 82.

after passing in front of the aperture, where it is steadied by friction rollers, is periodically struck by an eccentric rod or dog-motion, which draws down sufficient film to change the picture. The film is meanwhile constantly passed on at a regular rate to the store-reel by a sprocket-wheel. The specification further suggests that the eccentric need not be shaped as a rod or roller, but may take the form of a "blade,"

and several devices of this kind are shown in Fig. 83. This dog-motion or pitman is so generally employed that it is only right to recognise the name of Demeny as that of the originator of this type of machine; there does not appear to have been any mention before 1893 of the motion used in the Chronophotographe, though, considering the number of instances in which vague suggestion has been found to have long preceded practical application, it would probably be somewhat rash to definitely affirm the statement.



FIG. 83.

In November, 1893, Friese-Greene filed an English specification chiefly remarkable for its resemblance to Varley's invention of 1890 (Fig. 73). However, as the drawing shows the cam-driven arm more clearly, it is reproduced in Fig. 84.

Further extraordinary suggestions were made for utilising the apparatus in the production of moving stage scenery, a double dissolving shutter was shown, and it was said that cobalt salts might be used to colour films in order to produce change of tint under the influence of warmth; though how this principle affects a kinetographic film (which moves at short intervals of time and is specially protected from heat) was not explained.

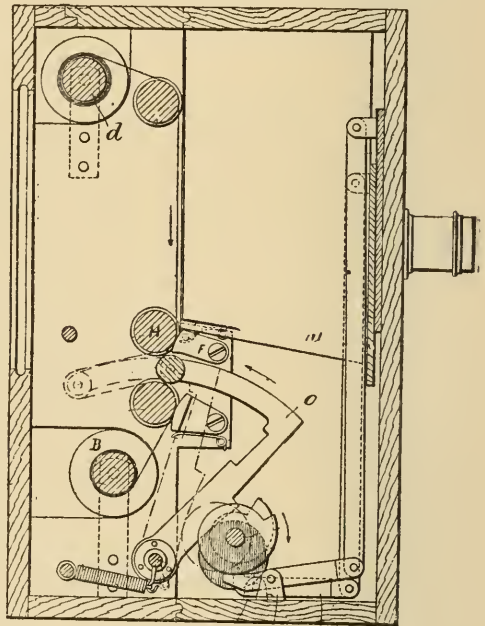

FIG. 84.

As a curiosity may be mentioned an idea published in 1893 in "The Optician and Photographic Trades Review." The suggested method of working depends largely upon the optical properties of the cyclostat, an instrument for rendering a revolving body optically stationary by means of a prism rotated in the same direction as the body under observation, but at half the angular speed. If, now, we have a revolving circular sensitive surface, we can render it optically stationary by means of a cyclostat, and can take a photograph upon it by an exposure of any duration despite its continual rotation. But if the sensitive surface is formed of a portion of a flat spiral, lying on a plate through a slot in which it is fed up and withdrawn, this very action causes a rotation. This rotation will be neutralised as a whole by the cyclostat, but the portion of the spiral acted on will nevertheless be continually added to on one side and drawn away on the other. The image of any object will be therefore rendered optically stationary, but will be subjected to blurring due to its proper movement during the time that any specified portion of the spiral is exposed, as of course is the case in every photographic exposure. But as the film dips down through the slot a fresh piece is fed up and receives the image in the same stage as the withdrawn portion and itself starts on its circular trip. By this means the extent of blurring is kept within the usual limits. If a similar spiral positive film is fed through the slot in the same manner and viewed by means of a cyclostat a moving picture may be seen, and as persistence is not called into question, the rate of revolution of the spiral may be far slower than the speed at which the photograph was obtained and which was governed by the necessity of making one revolution in a sufficiently short time to obviate conspicuous blurring. Such an arrangement does not lend itself



to projection (except aphengescopically), but would be suited for direct inspection. No trial instrument on this principle appears to have been made; the complications caused by photographic manipulation of a spiral film are probably quite a sufficient bar to the experiment.

A new principle was introduced by Jenkins in 1894, his United States specification having been filed on January 12th of that year, though not issued until May.

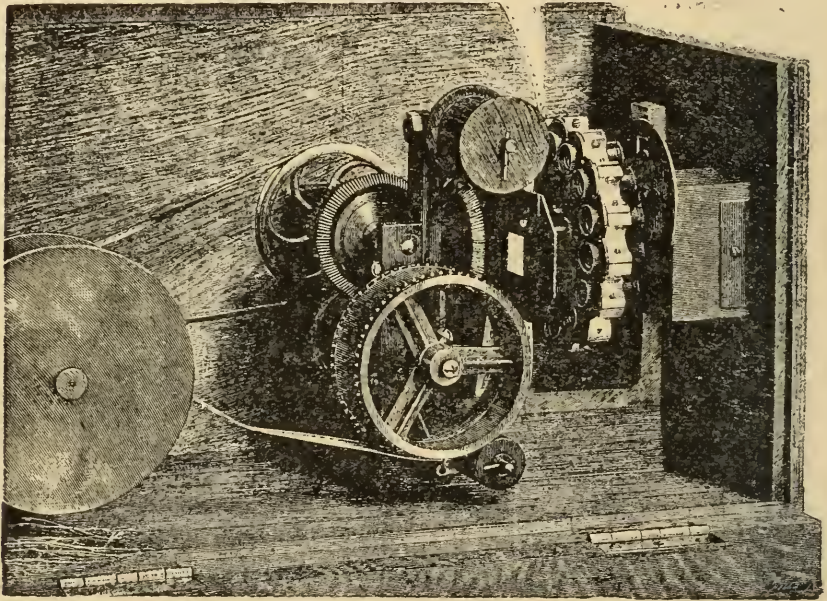

FIG. 85.

1896. The *Phantoscope Camera* (Fig. 85) employed a continuously moving film in front of which revolved a disc bearing a number of lenses. The speed of this disc was so determined that each picture on the film was accompanied in its travel past the aperture by an accurately centred lens; and though the film was moving in a right line and the lens in a circle, projection took place over so small an arc that the deviation from a right line was insensible. Though the lenses pass



an opening in the casing, a little reflection will show that if the aperture be rightly proportioned it does not act as a shutter; on the contrary, the pictures are independent, the formation of one beginning before the exposure for the preceding one has ceased. This apparatus should be reversible, but as a matter of fact Mr. Jenkins adopted a different system for his projecting Phantoscope which was not exhibited until 1895, nor described until 1896. The interest of the Phantoscope Camera resides in the fact of its similarity to Uchatius' arrangement of 1853; both had the image and lens in fixed relation, but while Jenkins moves image and lens together, Uchatius kept them stationary and moved his source of light. This resemblance is, however, of purely historical import; no comparison is possible respecting efficiency. There is no doubt but that Mr. Jenkins has not only successfully operated this form of apparatus as a camera but has also employed it for projection purposes; still it may be questioned whether such a machine could be popularly introduced. In the first place the cost of a multiplicity of first-class lenses is practically prohibitive, and though their number can be reduced, yet every reduction operates to impair the efficiency of the machine. In fact, in an apparatus of this type a large circle of lenses is essential in order that the arc described by the path of the lens may approximate to a right line, and Mr. Jenkins therefore employed quite a different form of machine for projection purposes, and subsequently used it for taking photographs as well. This machine will, however, be treated of in its proper chronological sequence at a later stage. In the November of 1894 the same inventor filed another United States specification (No. 536,569) for an inspection apparatus somewhat on kinoscope lines, but without a shutter, the film being intermittently illuminated by the action

of two incandescent lamps mounted on a revolving arm.

With the commencement of the year 1895 considerable activity was manifested in the United States no less than in France and England, and it is to that year we must look for the appearance of the Living Picture in its final form—that of a perfected and popularly

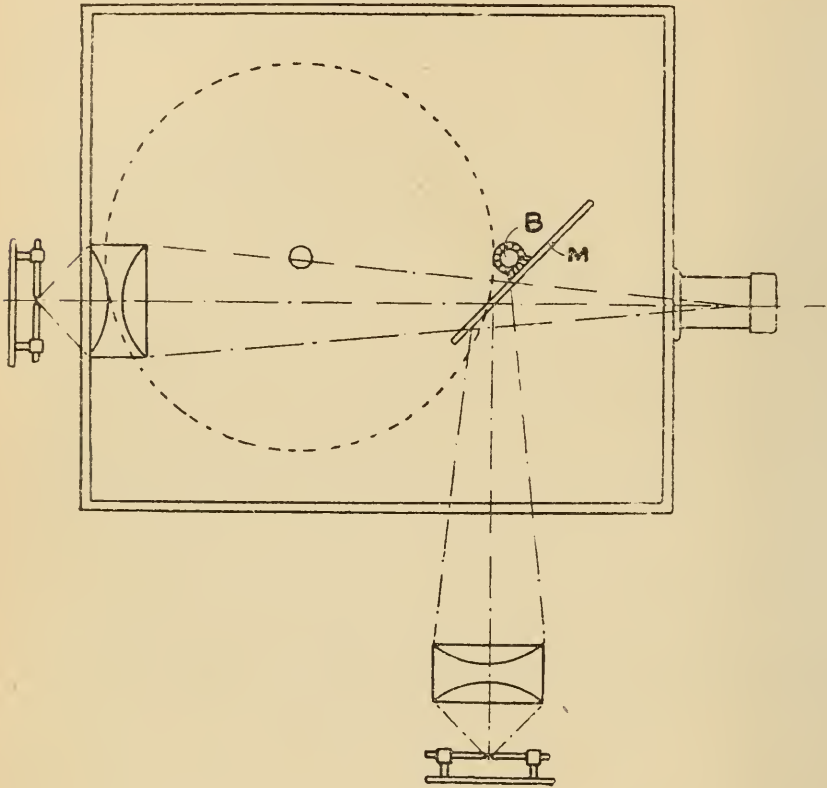

FIG. 86.

successful projection exhibition. On March the 9th a most ingenious specification was filed in the United States by Gray, and subsequently issued on June 4th as No. 540,545. It is perhaps questionable whether perfect registration could be obtained with so many movements applied to the same film, but there is no doubt as to the novelty of the methods proposed.

The apparatus being designed both for projection and securing negatives, the drawings illustrating the former purpose will serve to explain the whole method, which was one of double projection through one lens. Leaving the film out of the question for the moment, Fig. 86 shows two arc lamps each furnished with a condenser. From one of these condensers a beam of light proceeds directly to the projection lens; if this beam be disregarded, it will be seen that the light from the other condenser is caused to follow the same path by a mirror, M, set at an angle of forty-five degrees. This mirror is shown in elevation in Fig. 87, and consists of

a half-circle of silvered glass, the other half-circle being transparent. The mirror is rotated by bevel gear, B; and provided that the two beams of light bear on it below or above its centre, the direct beam will pass to the projection lens when the transparent portion is in position, while the light from the lamp at right

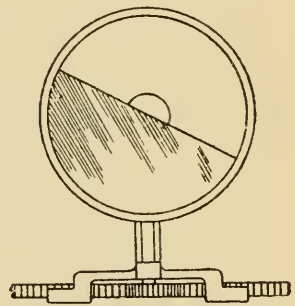

FIG. 87.

angles will be thrown on the screen when the silvered part comes round. Also, in a certain position, portions of both beams of light will reach the projection lens; that is to say, one beam of light will be vignettted into the other and there will be no interruption of illumination. This being well understood, we will in imagination interpose the necessary film, do away with the arc lamps and condensers, and consider the apparatus to be working as a camera. Looking at Fig. 88, the film is seen coming from the right-hand, dropping to the extent of half its width, and being drawn along by forked fingers in order to be wound up on a receiving-spool. The oval seen in the middle is the mirror, in rapid rotation, but at present engaged in deflecting the beam

of light in order to throw an image on the lower portion of the film on the right-hand. As it continues turning, the silvered portion passes and the beam of light traverses the transparent glass and begins to form an image on the upper part of the film directly in front of us on the other side of the fork, and at this stage both parts of the ribbon are being acted upon; exposure at right angles is not quite finished, exposure in a right line has begun. So soon as the mirror has turned sufficiently to allow the whole beam of light to come straight on in the ordinary way, the exposure at right angles terminates and that part of the ribbon is

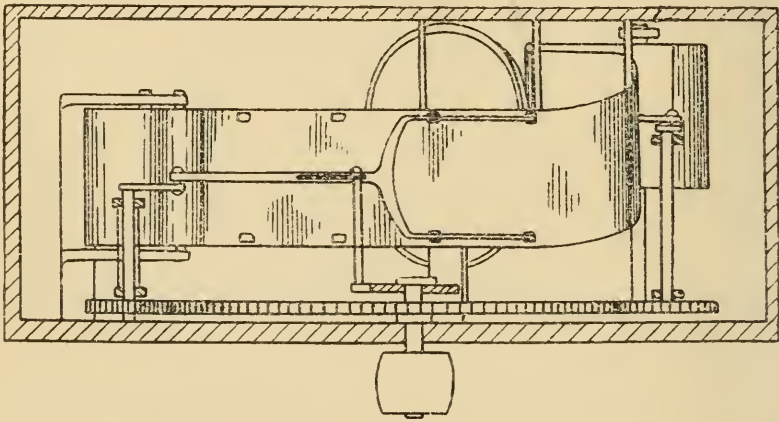

FIG. 88.

moved on by a similar fork to that seen in Fig. 88, thereby throwing up a loop. In the same way, when the mirror begins to cut off the direct light it also commences a new exposure on the fresh surface at right angles, but there is always a time when both portions of the ribbon are stationary and receiving concurrent impressions. The result is a ribbon bearing a double set of pictures, the upper series being obtained direct, the lower at right angles, and every one vignetting, so to speak, into both its predecessor and successor. The claws are driven to and fro by a



crank, as shown in Fig. 89, the tooth dragging over the film in one direction, but being pressed into the perforation by a spring when travelling the other way. The complication of a triple movement of the film would doubtless render accurate registration somewhat difficult with this apparatus, and it may be thought that more emphasis has been laid on it than it deserves; but when it is remembered that this machine contains the first of a long series of claws and spring teeth for moving the film, and

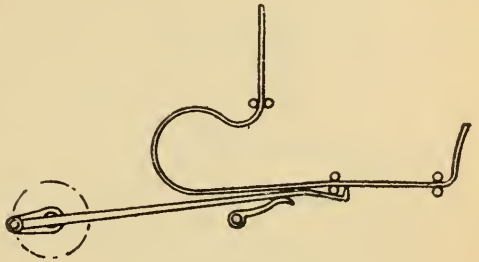

FIG. 89.

also shows a semi-circular rotating mirror for deflecting the light (a device patented in another connection at a far later date), it will be conceded that the ingenuity displayed by the inventor calls for recognition.

A few days later, on March 25th, 1895, Eames filed a specification in the United States, subsequently issued as No. 546,093, showing an arrangement which could only be called an improvement on Jenkins' Phantoscope Camera if the question be considered in an economic sense. The number of lenses was reduced to two, a substantial saving in expense of construction, but the disadvantages introduced appear to outweigh the saving secured. It is of almost vital importance that the individual views be obtained from the *same point of view*; if succeeding pictures be secured by lenses placed side by side, a variation in position of foreground objects results as a matter of course; and this variation, which is essential in stereoscopic work, is prejudicial under other circumstances and bound to cause a false vibration of objects on the screen. It cannot be denied that enough trepidation exists in

the average Living Picture without risking a further importation of so little desirable a characteristic! Still, the *Animatoscope* is a distinct type of machine, and as such it must be described. A single film is employed; but this film is of double width, and travels continuously downwards behind a pair of lenses mounted on sliding panels (Fig. 90). A circular shutter, furnished with two slots, each extending halfway round, revolves between lens and film. Presuming that exposure has just

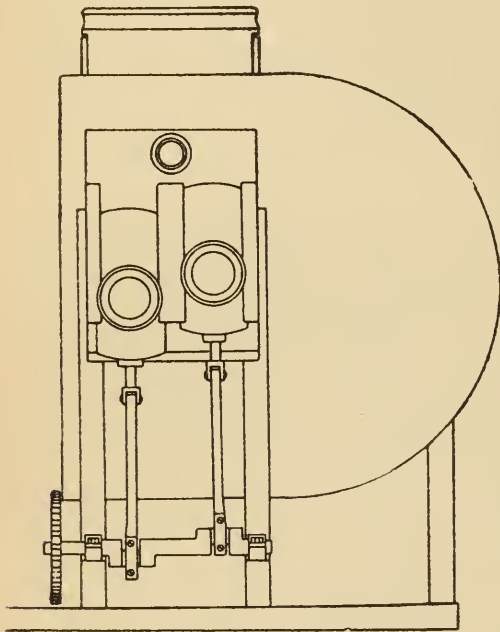

FIG. 90.

commenced with the right-hand lens, the cycle of operation is as follows. The film descends at a fixed rate, so also does the lens, it being drawn down by the crank-rod attached to the front panel. The lens does not, however, travel at exactly the same speed as the film; the moving parts are so geared that when used for projection purposes a line connecting the

centre of the picture with the centre of the screen shall always pass through the optical centre of the lens. While this right-hand lens is descending, the left-hand one is rising, but has no action on the film because the light is cut off by the shutter. So soon as the lens begins its descent light is admitted to act, and at this time the position of affairs is such as to display the characteristics of the machine. One lens has reached the bottom and is just terminating its

exposure; the other lens is situated at half a picture height above and is just commencing to act. The result is shown in Fig. 91, where the two series of pictures are seen side by side upon the film, the upper margin of one picture being level with the centre line of that which follows. The speed of the film is therefore reduced to one-half, the alternating exposures or projections overlap, and all parts of the apparatus are in continual movement. By these means it is claimed that unsteadiness is avoided, while it is certain there is no interruption of light either in camera work or exhibiting.

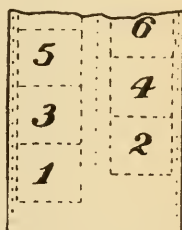

FIG. 91.

And now the turning-point in the History of the Living Picture is reached. Up to this date the Kinetoscope was the only instrument of a distinctly popular nature, and it may be safely affirmed that, whatever may have been done in the way of private experiment, no public exhibition of a projected Living Picture had been a popular success. With the advent of Messrs. Lumière's *Cinématographe*, however, this desirable consummation was attained, and to them must be attributed the credit of stimulating public interest to such a pitch as to lay a firm foundation for the commercial future of cinematographic projecting apparatus. It was on the 13th of February, 1895, that Messrs. Lumière filed their French specification No. 245,032, their English patent being dated the 8th of April. To the French documents four or five additions were made, and a further English patent was taken a year later. As, however, these additions are but slight expansions of the original ideas, it is perhaps as well to describe them together. It may be mentioned that the *Cinématographe* was exhibited at Marseilles in April, 1895; and a display given at Paris in the following July was the



commencement of a career of unequivocal success. The beauty of the Cinématographe resides as much in its simplicity as in the results obtained, and no apology is required for a somewhat lengthy description being given of a machine which has attained a position of

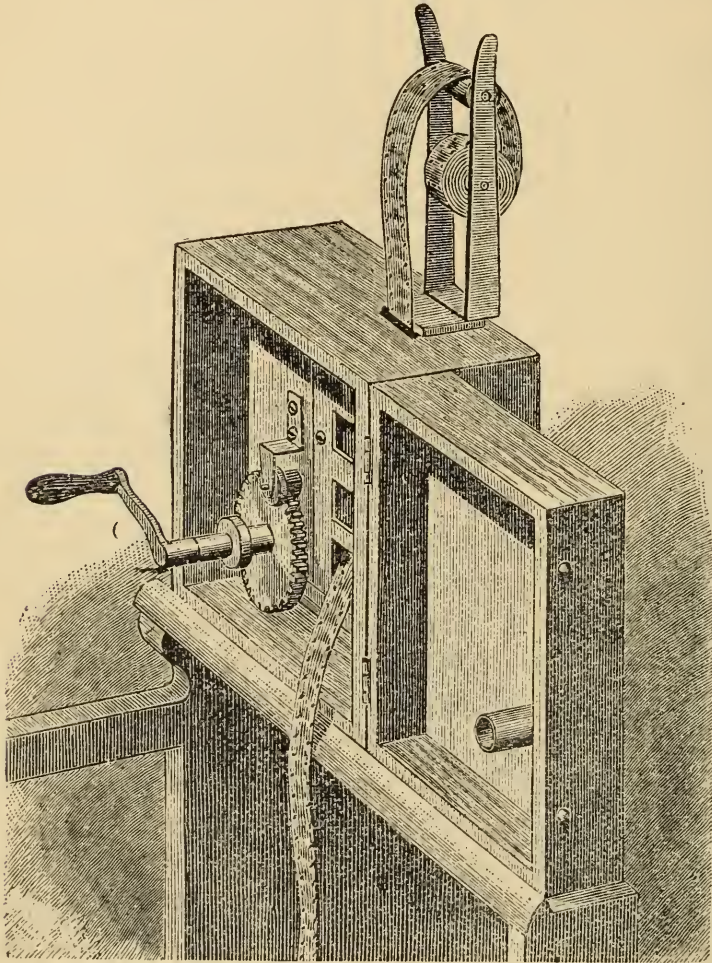

FIG. 92.

historical importance. Fig. 92 shows the casing opened, while Fig. 93 clearly exhibits the hidden mysteries. First and foremost, let it be supposed that the machine is arranged with a view to projection; the film-spool is placed in a holder at the top and the film is led



through the machine. It will be seen that the film is only provided with two holes to each picture, one on each side. Briefly stated, the action of the machine is as follows. A picture is at rest opposite the lens, but so soon as a rotating shutter cuts off the light two little pegs enter a pair of perforations and then sink down, carrying the picture band with them to the exact extent of one view. The pegs then come to rest, steadying the film, and are withdrawn in order that

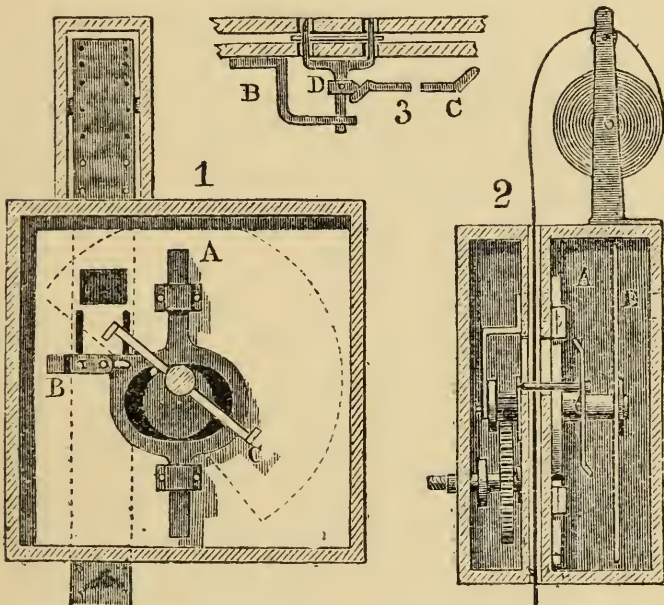

FIG. 93.

they may rise preparatory to drawing down a fresh portion. While they are rising the shutter passes away and allows the stationary picture to be projected. How this is accomplished will be understood by reference to Fig. 93. The pegs are carried by an arm, B, fixed on a frame, A, which is driven up and down by a central cam. A rotating arm, working from the same centre as the cam, has wedge-shaped ends, and the pins are not rigidly fastened to the arm, B, but are formed like

the prongs of a little fork which can slide backwards and forwards. Every time the pegs arrive at the top, the wedge on the end of the rotating arm acts against another wedge, D, on the fork and drives the pegs into the perforations. This done, the frame, pegs, and film sink together. Arrived at the bottom, the other end of the arm, furnished with a wedge slanting the other way, comes round and acts on the other side of D in order to draw the pegs out so that they may rise without moving the film.

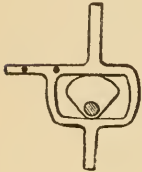

FIG. 94.

This is the whole principle of the machine in its simplest form, but its efficiency depends on an important modification. If the central cam were a disc, as shown in Fig. 93, the frame would take as long to make its downward journey as it would to travel in the reverse direction; and, further, the motion would be continuous. Therefore the cam is formed as shown in Fig. 94, with the result that while the cam turns through 60 degrees the frame remains stationary for the insertion of the pegs; a further movement of 120 degrees drops the frame, the pegs drawing the film down. During the next 60 degrees of rotation the frame remains still to allow the pegs to be withdrawn, while the 120 degrees required to complete one rotation are occupied by the rise of the frame. Therefore the film is only in movement for one-third of the total time of one revolution. Some further modifications are shown in Fig. 95. Instead of driving the cam at a

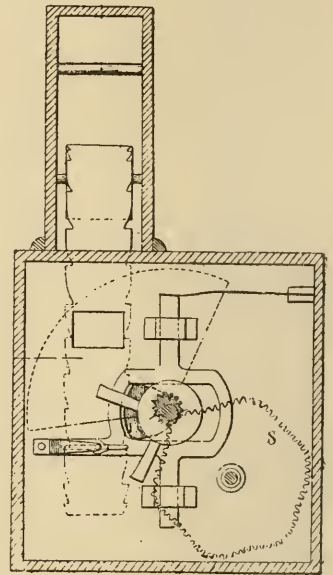

FIG. 95.

Instead of driving the cam at a

regular speed, the toothed wheel S may so act on the shaded wheel as to cause it to rotate more quickly at one period than another, and in consequence the film may be drawn down quickly, while the raising of the pegs occupies a longer time. As the film is stationary during the rise of the pegs, the picture may be projected for considerably more than one-third of a complete revolution, and the period of darkness is consequently reduced. The two arms that act on the pegs are therefore placed closer together and project from the edge of a disc, better seen in Fig. 96. Subsequently these arms disappeared, their functions being discharged by variations in the surface of the disc itself; but the

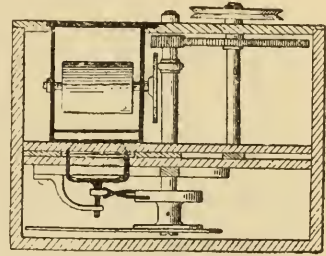

FIG. 96.

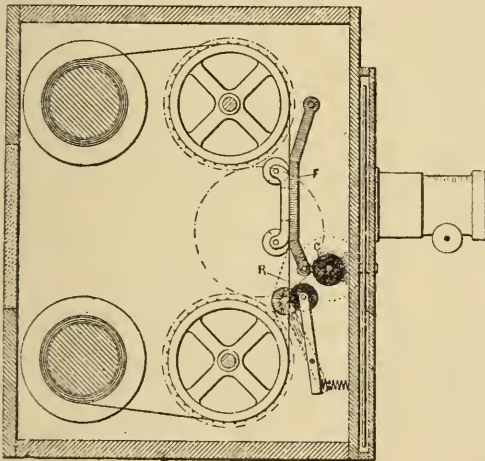

FIG. 97.

latest developments of this machine will be illustrated in the next chapter.

While Messrs. Lumière were triumphing over their difficulties in France, the problem was also being attacked on this side of the Channel. It is certain that Mr. Birt Acres was working

concurrently with Messrs. Lumière, for he photographed the University Boat-race with his *Kinetic Camera* on March 30th, 1895, only a few days after Messrs. Lumière filed their French patent, and before the deposit of their English one. In fact, Mr. Acres



appears to have been beaten all through the race by a few days; his English patent is dated about five weeks after Lumière's, and he does not appear to have given a public exhibition until the early days of 1896. But this point is of little importance, for his apparatus was constructed on distinctly different lines to those adopted in the Cinématographe. Fig. 97 shows the *Kinetic Camera* at the commencement of an exposure. The film is firmly held by the shaded clamping-frame F, pressed home by the black cam C. While exposure is proceeding the upper sprocket-roller is feeding out an exact picture-length—that is to say, it moves four teeth forward. So soon as the shutter cuts the light off the clamping-frame is loosened, and the roller R, which has been bearing against the film, is thrown into its shaded position by the action of a spring, thus drawing down the slack which has accumulated above the clamp and substituting a fresh sensitive surface, which is at once firmly held in position. A fresh exposure now commences, during which the bottom sprocket-roller takes up the looped film and so gradually forces the roller R back into its original position ready to act again when the clamp is taken off. This apparatus has undergone several christenings. Brought out in January, 1896, as the *Kinetic Lantern*, this term was abandoned the following March in favour of the name of "*Kineopticon*." Being called to give an entertainment before the Prince of Wales in July, the inventor found, to his surprise, that the programmes issued under Royal auspices referred to his invention as the "*Cinematoscope*." What could a loyal photographer do except follow the same course as Mr. Acres actually did? Cinematoscope it was by Royal dictum, and Cinematoscope it remains to this day. But as "a rose by any other name would smell as sweet," so has the Cinematoscope retained its good qualities under all its varied nomenclature.



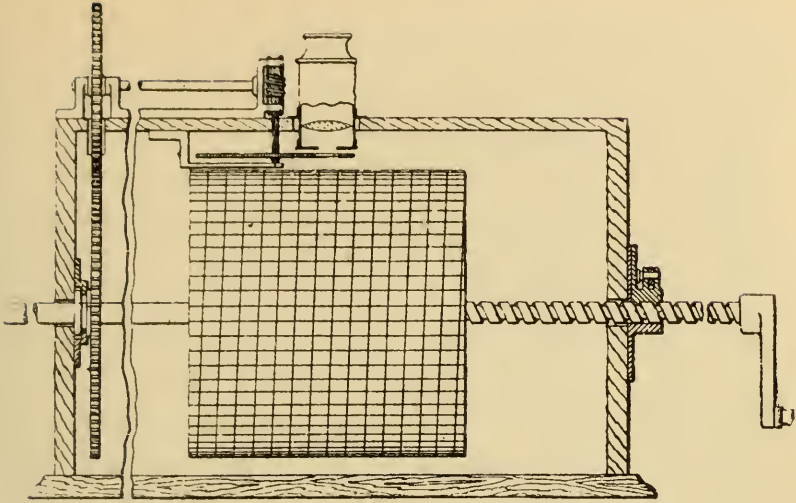

FIG. 98.

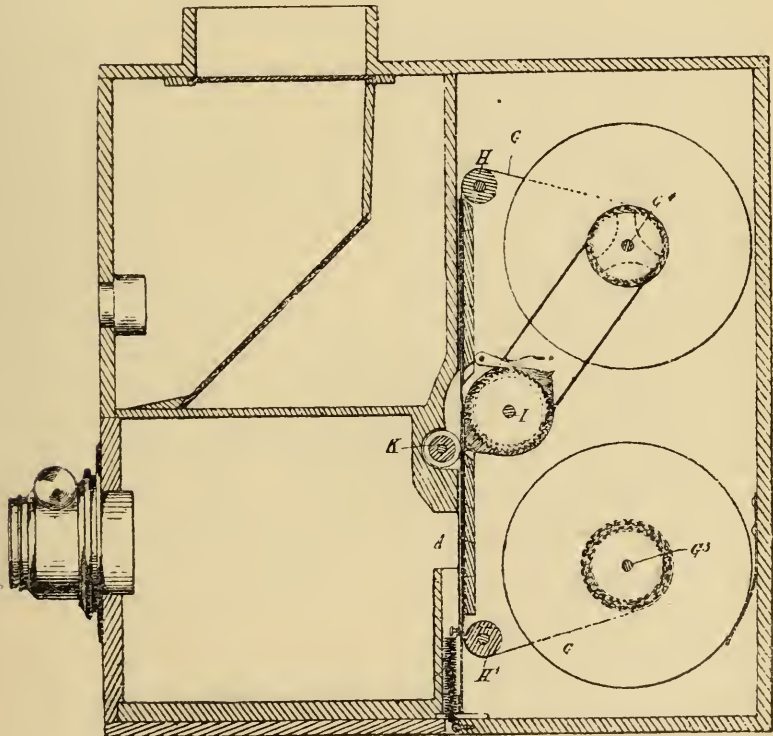

FIG. 99.

In order to maintain a chronological sequence, an apparatus may be here noticed which is chiefly remarkable for its resemblance to Demeny's drum-form Phonoscope, Figs. 65 and 66. The shutter is, however, revolved between the eye-piece and the image, instead of between the light and the drum; and the drum itself, instead of moving transversely, as seen in Fig. 98, may remain stationary while the eye-piece is shifted instead.

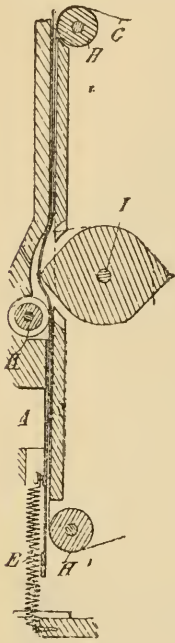

FIG. 100.

The following month (June, 1895) Blair took an English patent for a kinetographic camera in which the shutter acted on the usual focal-plane principle—that is to say the exposure was made through a slit passing over the sensitive surface. Fig. 99 shows the film passing from a lower spool, over tension-rollers H', K, H, on to an upper receiving - spool. A peculiarly shaped roller, shaded in drawing, revolves on an axle, I, and is prevented from turning backwards by a ratchet.

Supposing an exposure just terminated, the parts would be in the position shown in the illustration. The lower tooth on the shaded roller then passes through a hole in the film and also through a hole

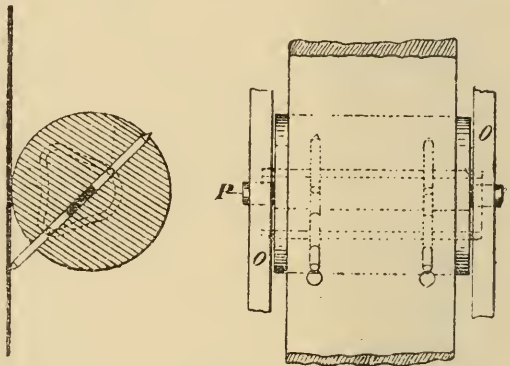

FIG. 101.

in the top of the flexible shutter which lies in front, and raises both together as seen in Fig. 100. The film is protected by the shutter, in which, however, there is

a transverse slot, and the light will act through this narrow slot on the film which lies behind. So soon as this slot arrives level with the top of the aperture A, the tooth on the roller leaves the perforations and the film remains at rest. This withdrawal of the tooth also releases the shutter, which is rapidly drawn down by the spring E, and as the slot passes over the sensitive surface an exposure is made. The working parts are then in the original position, ready for another movement of the film. It will be seen that this system gives a succession of views separated by a blackened strip the width of the shutter slot. It was also suggested that instead of specially shaping the roller which carried the pins it

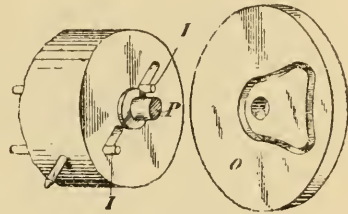

FIG. 102.

might be made cylindrical as shown in Fig. 101, the pins being periodically protruded from its surface and subsequently retracted by means of the T-shaped head of each pin, I, taking into a cam-groove in a plate, O, mounted at the side of the cylinder. The arrangement of these parts will be seen in Fig. 102.

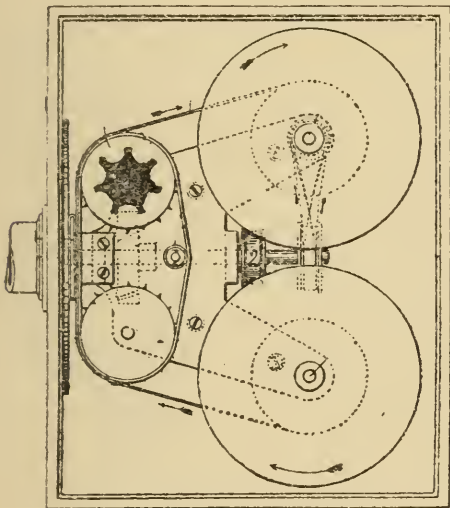

FIG. 103.

On the 16th of July, 1895, Petit applied for a patent in the United States (No. 560,424), and his device for moving the film intermittently forms a capital example of how a given mechanical movement may pass into

another form. The camera, Fig. 103, follows the usual type in its main arrangement, but only one of the sprocket-rollers is driven; the other one rotates by means of a band which passes over both, being perforated exactly as a film.

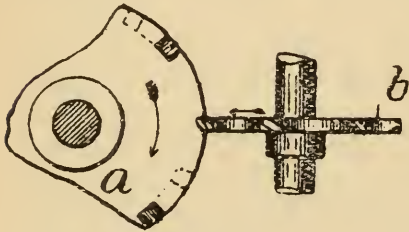

FIG. 104.

The film itself travels in contact with this band, which not only ensures the equal movement of both sprocket-rollers, but also lends support to the film.

Intermittent rotation is secured by means of a star-wheel, shown black on drawing, attached to the same axle as the upper sprocket-roller. This star-wheel is marked *b* in Figs. 104 and 105, and at the first glance there appears a great resemblance to Edison's device shown in Figs. 78 and 79. But this latter was purely an escapement mechanism; the toothed wheel always had power applied to it, but could not turn because it was locked, and therefore its driving-pulley slipped. When a slot arrived in place the tooth escaped straight through it; the interaction of the wheels supplied no power. But in Petit's machine the slots were *not* straight; they acted as cams.

It will be seen that the wheel *b* was held perfectly steady, the wheel *a* resting between two teeth. As the slot 3 approached the wheel *b*, a slight protuberance, 4, drew a tooth into the slot, which then forced the tooth through to the other side of the wheel *a*, thus rotating *b* and the sprocket-roller with it. It will be seen that *a* serves the double purpose of driving *b* round intermittently and also of steadying it between whiles.

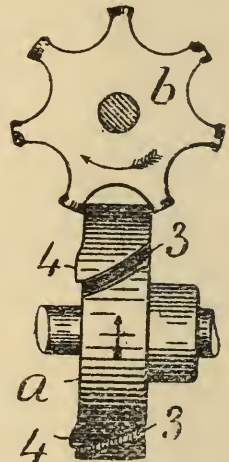

FIG. 105.



Another invention of considerable interest was patented in Germany by Müller of Cologne on the 25th August, 1895 (No. 92,247). There is no need to give a full description of the apparatus, for Fig. 106 proves that it was identical in principle with Acres' Kinetic Camera shown in Fig. 97, a spring-actuated

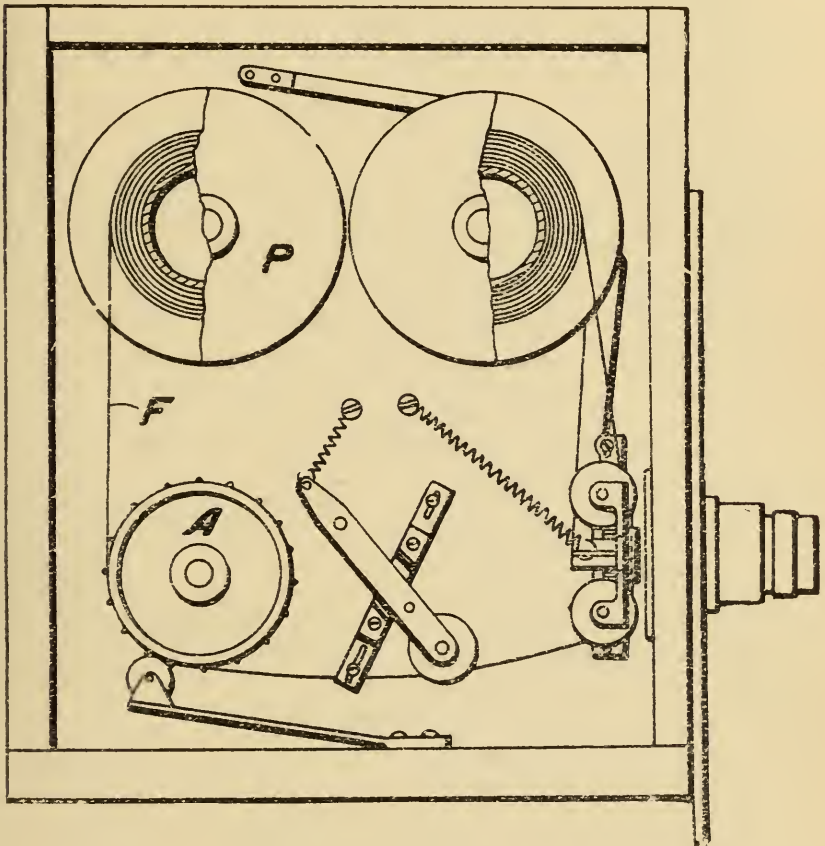

FIG. 106.

roller drawing the film onward whenever a clamp was taken off. Müller's arrangement of the clamp differed somewhat from that adopted by Acres, as will be better seen in Fig. 107, where the clamp L has just been withdrawn from contact with the film F. This invention affords an interesting instance of independent invention of the same device; for Müller's specification

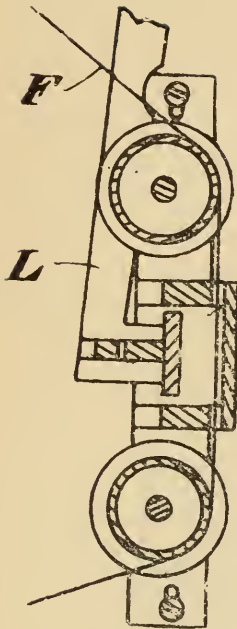

FIG. 107.

was filed in Germany after Acres' English application, but at least nine months before the Kinetic Camera was publicly described, and it may therefore be assumed that this coincidence is but one more verification of the theory that "great minds think alike."

A French patent, dated the 26th of August, 1895, was granted to M. Joly for an apparatus working on much the same principle as Varley's invention of 1890 (Fig. 73). Fig. 108 shows the film accumulating behind pressure-rollers, K, and then passing through a steadying-frame, *j*, and clamp, better seen in Fig. 109.

The film was drawn down by a reciprocating roller on a lever, but this lever was turned the reverse way to Varley's arrangement, and instead of being tilted forward by a cam, it was driven back by its connection with an eccentric pin on the disc E.

In the following month (September, 1895) Friese-Greene patented a camera which is only noticed here because it has been referred to as a kinematographic apparatus. Certainly the specification speaks of producing a

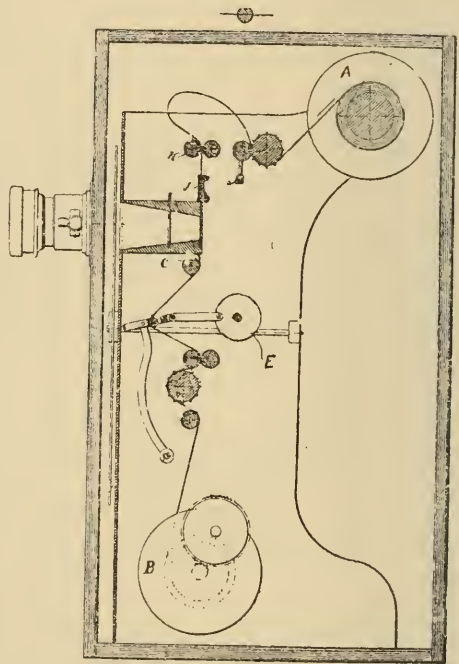

FIG. 108.

series of photographs successively, but a glance at Fig. 110 will show that if the black wheel be rotated continuously the period of rest will be far shorter than the period of movement. When it is seen that a stop is provided for giving time-exposures and a marking arrangement indicates where the film may be cut between the views, there seems little doubt but that the apparatus is merely an ordinary hand camera.

The same day (25th September, 1895) Petit took a United States patent (No. 560,425) for a multiple-view Kinetoscope.

The film passed from one spool on to another (N, Fig. 111), being driven by sprocket-rollers. Between the film L and the eyepieces an endless band, B, passed in the opposite direction around drums, P. This band was pierced with slots and acted as a shutter.

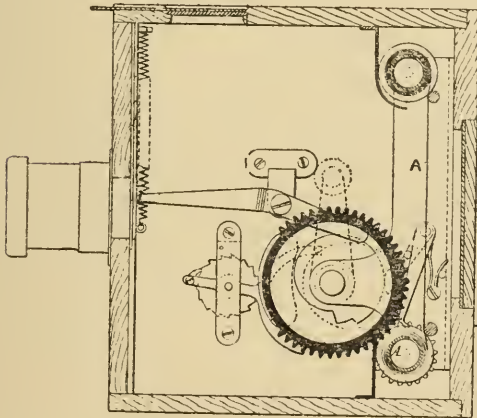

FIG. 110.

shutter is a slotted drum revolving between the light and the film. The slot is just in position,

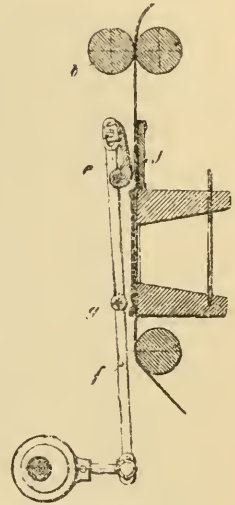

FIG. 109.

reversed in order to return the film to its original spool. The English patent (No. 10,778 of 1896) included both this and the camera previously described under United States specification No. 560,424. In addition, another form is shown (Fig. 112), wherein the

allowing light to pass through the film and the eyepiece C, the other inspection openings being

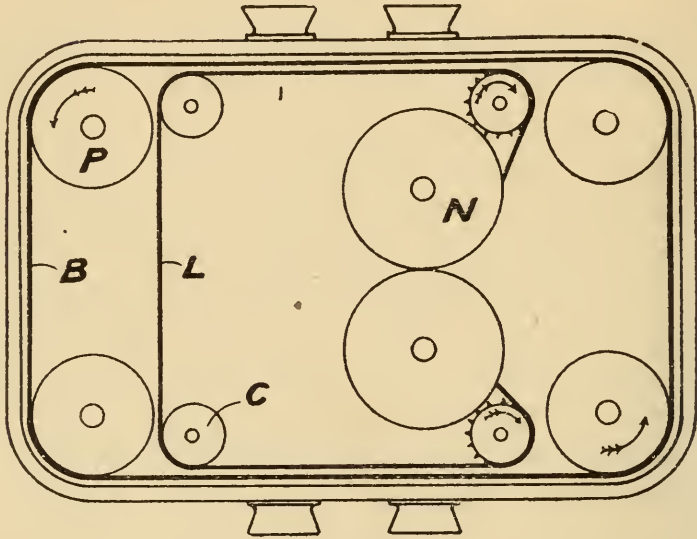

FIG. 111.

similarly lit up in the course of one revolution of the drum.

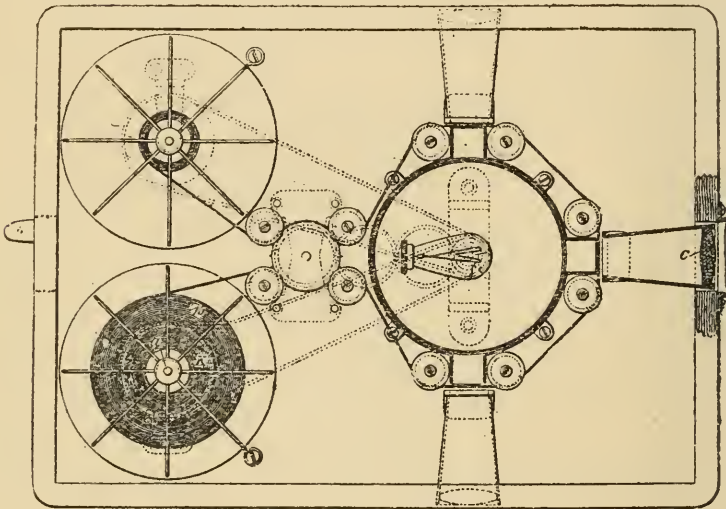

FIG. 112.

On the 1st November, 1895, a German patent (No. 88,599) was applied for by Max Skladanowsky, who



appears, on his own showing, to have occupied the same position in Germany as Lumière in France, Acres in England, and Jenkins in America; that is to say he was not only the populariser of the Living Picture in his own country but was also an independent inventor. He gave the first exhibition of projected Living Pictures in Germany on the very day on which he applied for his patent. His apparatus had, however, been constructed fully a year before, without any knowledge of the efforts which were being made in other countries. The chief feature of this apparatus was the arrangement of the parts employed for moving the film. The toothed wheel seen in Fig. 113 is in connection with the sprocket-wheel,

and is driven by the worm below. Were this worm fixed it would rotate the wheel continuously, but it is mounted on a sliding axle driven backwards and forwards by a

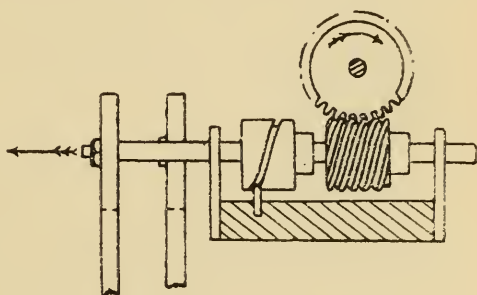

FIG. 113.

stud bearing in a cam-groove. Thus at one time the wheel remains stationary, the worm, so to speak, screwing itself along on the wheel; but when the axle travels back, not only does the worm act in its proper manner but in addition drags the wheel round. Herr Skladanowsky at first used two machines giving alternate projection, but subsequently employed one machine only, having a special form of shutter. His pictures measured 4 by 5 centimètres, and therefore gave a considerably larger view on the screen than those obtained with the first French machines.

The last apparatus to be described in this chapter stands in a manner on the borderland of history. Mr. Jenkins undoubtedly constructed his *Phantoscope*

*Lantern* so far back as 1894, though no description of its working appears to have been published until 1896. Still it was exhibited towards the end of 1895 both at the Atlanta International Exposition and the Franklin Institute. Shortly after this, on March 17th, 1896, the instrument was, according to Mr. Jenkins' own account, surreptitiously removed from his house at Washington, and he maintains that a similar machine was subsequently put on the market under the name of the Edison Vitascope. There may very well have been

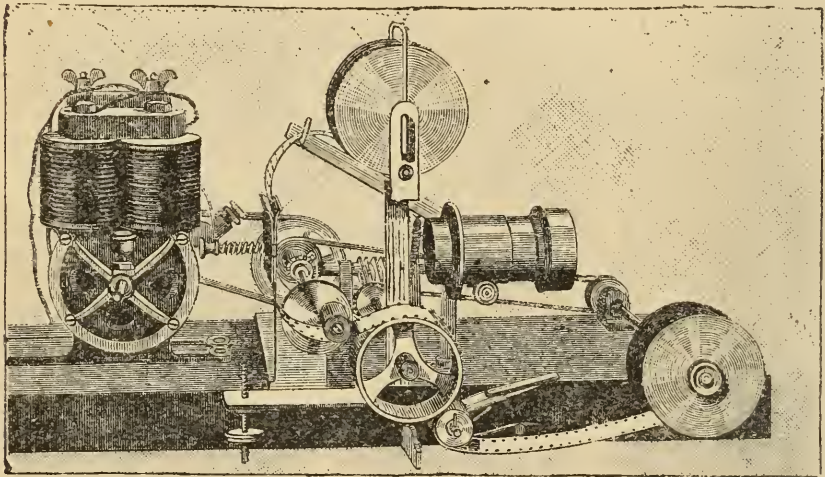

FIG. 114.

no connection between the two events, for the Phantoscope itself was strikingly similar to Demeny's Chronophotographe, dated 1893. Both depended on a dog-motion for the intermittent movement of the film, but the general arrangement of the two machines was somewhat different. The Phantoscope (Fig. 114) was electrically driven; and, as the period of motion was only one-twenty-fifth of that of rest, a shutter was dispensed with. In fact, Mr. Jenkins claims to have used a similar apparatus without a shutter for camera work, the amount of light reaching the film while in

motion being so small as to cause only an imperceptible degree of fog.

Here, then, History ends. It is a comparatively simple matter to present facts in some sort of sequence after the lapse of time, but a space of two years affords so little perspective that it is better to terminate our journey through the "has been" at the end of the year 1895. In fact, at that date practically every device connected with the production of a Living Picture had been described or at least foreshadowed; all leading principles had been enunciated, though the methods suggested for carrying them into effect were capable of considerable mechanical improvement. Plateau's simple rotating disc and Stampfer's suggestion of a moving band had gradually borne fruit; the improvement in photographic processes, the researches in the domain of pure chrono-photography, and the invention of celluloid all lent their aid, and successful exhibitions of projected Living Pictures in France, England, Germany, and the United States sealed the popular verdict that the Living Picture had arrived, fully and completely, in December, 1895. Therefore it is better to regard all subsequent machines and ideas as part of the actual present, as efforts to impart the finishing mechanical touches to several well-defined principles, and merely place on record in the next chapter such machines and projects as are now before the public in order that a clear idea may be formed of the actual position and degree of perfection of the Living Picture in this Year of Grace 1898.

## CHAPTER IV.

### PRESENT-DAY CAMERAS AND PROJECTION APPARATUS.

IN giving an account of present-day machines it is desirable to include not only those actually on the market but also such others as have been described by their inventors, even though but one machine may have been constructed. A much greater variety of design has been introduced than is commonly supposed to be the case, and an introductory review of principles will greatly assist subsequent comprehension of the working of individual machines. This course is the more desirable inasmuch as the efficiency of any given apparatus depends even more on excellence of workmanship than on the mechanical devices employed; and improved design is of little ultimate advantage unless accompanied by a more than equal advance in accuracy of construction. The action of a Living Picture machine is in every respect comparable to that of a clock or watch, and as regards these latter it is certain that workmanship is the main factor in the results attained; no doubt an English chronometer greatly excels a machine-made watch, but only on condition that far greater care is exercised in its construction; if this be not so, the probability is that the commoner article will prove the more satisfactory. So it is with Living Picture machines. The advantages and disadvantages of respective types may be discussed till no doubt remains as to which is the best, *theoretically*, but even then the final test can only be the performance



of individual machines, the action of which may vary in any two samples although both are of exactly the same design. Therefore in the following review of *principles* it must be taken for granted that the workmanship is perfect, and this assumption can only be verified by inspection of the machine in actual operation.

The central feature of all apparatus under consideration is undoubtedly a film bearing a series of pictures, and the various means suggested or employed to render each view apparently stationary form the best basis for the arrangement of a systematic review. Thus, the film may be:—

- A. Moved continuously, but be
  - 1. seen for a very short period ;
  - 2. rendered relatively stationary ;
  - 3. rendered optically stationary.
  
- B. Moved intermittently by rollers
  - 1. through interaction of wheel with teeth or pegs ;
  - 2. through interaction of wheel with worm or cam ;
  - 3. by changing position of the sprocket-roller itself ;
  - 4. by ratchet gearing ;
  - 5. by periodical grip of two rollers.
  
- C. Moved intermittently by teeth
  - 1. always in contact with film (spring-teeth) ;
  - 2. inserted and withdrawn (claw) ;
  - 3. or substitutes (as gripping fingers).
  
- D. Moved intermittently by pressure of
  - 1. eccentric ;
  - 2. reciprocated arm ;
  - 3. spring arm acting when clamp is taken off the film.

So far as possible all motions that have been suggested will be described in the above order, but one class has a tendency to run into others, and the arrangement cannot be regarded as a strict one. Still the attempt will serve as a brief recapitulation of past devices, and at the same time afford some idea of other methods recently proposed. It has been stated that the "description of an appreciable number of these machines would be a somewhat heavy and monotonous task," but it is to be hoped that, heavy and monotonous as the task of selecting details may be, the reader may yet be spared the mental indigestion which is the Author's due, and his alone. And so to proceed with a general outline review of every system of importance yet suggested.

AI. *Continuously moving film seen for very short period.*

This type is primeval. The Phenakistoscope worked on this principle, and Plateau's "Diable soufflant" was essentially similar although speed of image was reduced. From these two instruments were derived all such machines as the Lantern Wheel of Life, the Zoöpraxiscopes, and in a degree the Phonoscope; while Edison's Kinetoscope, excellent as the results were which it gave, nevertheless falls into the same category. But, even in so elementary a type, there is some scope for suggestion; and where vision is only momentary it is clearly desirable that as much light as possible should be passed through the slot. Lommel in 1881 attacked this difficulty by throwing a condensed beam of light through a narrow aperture working in the plane of the focus, and this same system reappears in Latham's invention of 1896, though in a considerably elaborated form.

*A2. Film rendered relatively stationary.*

Of this class there appears to be only one example, viz., Donisthorpe and Croft's machine, shown in Fig. 69. In this case object, lens, and image were all maintained in fixed relation; devices which move lens and film together are better regarded as belonging to the next class.

*A3. Film rendered optically stationary.*

The first attempt to render an image optically stationary was probably made by Clerk-Maxwell in 1869, as explained on page 26. His arrangement of concave lenses instead of zoëtropic slots is of interest in conjunction with Maskelyne's 1896 rotating lens-drum, which serves a somewhat similar purpose, though the comparison must be taken in a purely historical sense, and not in a practical one.

Another important optical method which has been put into practice is the use of a mirror turning at such a speed as to maintain the beam of light passing through the lens in a right line. The origin of this idea may be found in Reynaud's Praxinoscope (Fig. 23), and its latest developments in Campbell and Casler's inventions of the year 1897. Suggestions involving the use of a cyclostat, such as mentioned on page 85, also fall within the same category, the general principle involved being this: A revolving image may be rendered optically stationary by the interposition of a reflecting surface moving in the same direction but at half the speed. The two principal instances of moving lens and image together have been noticed in Figs. 85 and 90, and Bonelli's invention of the year 1865 also bears on the same question.

B1. *Film moved intermittently by rollers actuated by wheel and teeth or pegs.*

To introduce this class an illustration may be given which has nothing whatever to do with the Living Picture. In fact, a prize competition might be started for the first correct answer as to the use of the apparatus

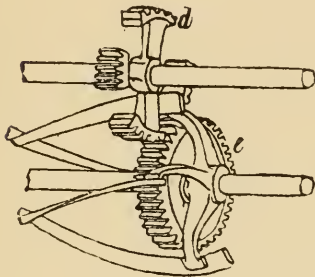

FIG. 115.

shown in Fig. 115; but as there are no prizes, it may be stated at once that the figure is a drawing of a lawn-mowing machine with projecting knives. Nevertheless, it will serve better than any other as a foundation for the discussion of principles.

Let us imagine the wheel *e* to be joined to the axle of an ordinary sprocket-roller, it will be seen that if the upper axle were rotated the wheel *e* would be partially revolved every time the segment *d* acted upon it. Further, if the segment contained the right number of teeth, the wheel *e* might be rotated to the exact extent necessary to draw the film onward one picture-length. The reason why a movement of this simple description would be ineffective is found in the fact that the ordinary Living Picture film requires to be started and stopped at least ten times in a second. Now, the momentum of the wheel *e* and film combined would carry the mechanism onward after the segment *d* ceased to act, and would therefore draw

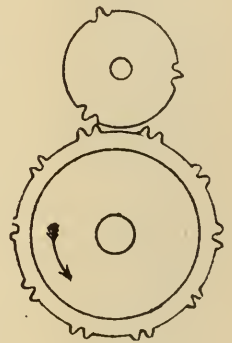

FIG. 116.

down more than one picture-length at each stroke. As exactitude in starting and stopping is absolutely essential in cinematographic apparatus, it is necessary that this point should be thoroughly grasped, and if



our outside illustration has succeeded in driving the fact home it will not have been dragged to light in vain.

The simplest form of this class is obtained by rearranging the teeth on the large wheel and reducing the segments on the upper one to a single tooth each, as seen in Fig. 116. Here it is the large wheel which is driven by the smaller, the large wheel standing still until a fresh tooth comes round, the plain part of the upper wheel resting against two teeth on the lower one, which is thus steadied. A further development of this plan

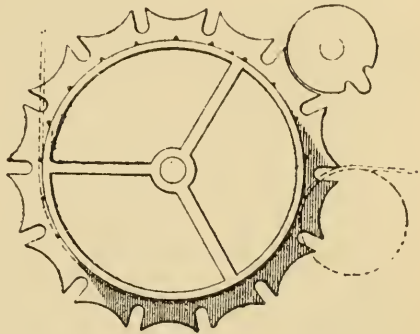

FIG. 117.

is seen in Fig. 117, where the small wheel only bears one tooth, the rest of its circumference being adapted to rest against the specially shaped intervals between the slots in the large wheel in order to effectively steady it. The single tooth may be replaced by a peg, shown black in Fig. 118. This peg, standing out from a disc, enters a slot in the Maltese cross attached to the sprocket-wheel, gives it a quarter-turn, and then passes on, leaving the cross steadied by the raised portion of the disc which carries the pin. This arrangement moves the cross once for every revolution of the pin-disc; if the latter bears two pins it will of course act twice instead of once,

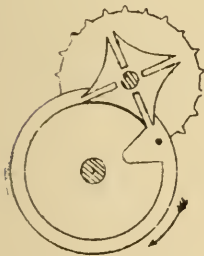

FIG. 118.

as seen in Fig. 119, wherein pins are replaced by rollers in order to reduce friction. This motion is applied to the bottom sprocket in order to pull down loose film which has accumulated behind a grip, but two sprocket-wheels may be simultaneously actuated by the arrange-

ment shown in Fig. 120. This Maltese cross motion is one employed for very many years past in horology under the name of the Geneva stop, wherein the arms

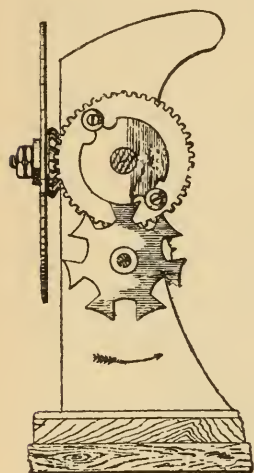

FIG. 119.

of the cross were hollowed at their ends so as to bear very accurately against the curved edge of the pin-disc exactly as shown in the drawing. One of these arms, however, was not hollowed, and therefore locked against the disc in order to prevent further rotation which would have resulted in over-winding; hence the name of stop. Though this stopping motion was its first use, the arms were soon made alike, thus permitting continual rotation, and the device has long been employed in varied branches of mechanical engineering to convert continuous into intermittent rotation on exactly the same principles as those applied to the machines under present discussion. If desired, the whole arrangement may be reversed, and instead of the pin driving the slot, the slot may drive the pin. The lower slotted disc on Fig. 121 pushes one pin on at each revolution, driving the previous one past the spring grip, which then locks the wheel in exact position.

B2. *Film moved intermittently by wheel-teeth inter-acting with worm or cam.*

A disc with pegs may be driven by other means. For instance, if another disc be placed "sideways-on," so that it bears against the pins, a groove such as is shown in Fig. 122 may be arranged so that the pins, in turn, enter and pass through it. Imagine the disc G in rotation and a peg entering the slot at A. While the disc turns halfway round the peg will be firmly

held in the same position, for the groove remains at the same distance from the centre of the disc. So soon as the groove begins to approach the centre the peg will be raised until it passes out at the end B, when another peg enters at A and is held firmly in the same manner as the previous one was, and thus renders the film steady. But this cam-groove may be applied in a more ordinary fashion in the form of a "drunken screw." If the wheel L in Fig. 123 be rotated so as to act on K, the latter will not be moved while all the grooves in L are straight.

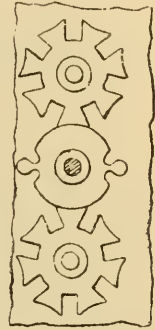

FIG. 120.

But so soon as the inclined part of the screw comes into action, K will be forced round some distance from one side to the other, and will then be held steady while the straight part again passes. Or the screw may be reduced to one thread, keeping in direct line for the major portion of one turn and rapidly passing over, as seen in Fig. 124. Instead of varying the pitch of the worm, a double motion may be

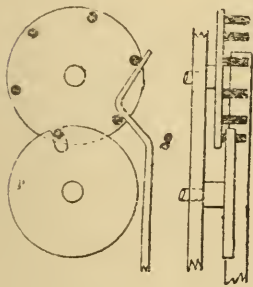

FIG. 121.

given to it, as was described in connection with Fig. 113. In Figs. 104 and 105 the outside of the turning disc acts in the same manner as the straight portion of the screw referred to in Fig. 123, while the groove acts the part of the inclined part. The little protuberance which draws the tooth over may of course be replaced by a kind of hook which forces it in instead, as seen in Fig. 125. A modification of this same movement is shown in Fig. 126, where a solid "snail" is employed.

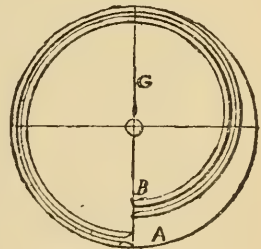

FIG. 122.

In this case the star-wheel, instead of being forced round through an inclined groove, is caused to follow

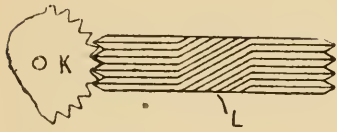

FIG. 123.

an inclined surface which acts somewhat as an escapement. The star-wheel is not directly attached to the driving axle A, but a spring is interposed, and

one of the rollers on the end of an arm is therefore always pressing against the edge of the continually revolving "snail" S. For three-quarters of a revolution this arm naturally remains still, but when the inclined surface of the long tooth comes round the arm follows it, making a quarter-revolution and turning the sprocket-wheel to the same extent. So soon as the arm escapes from the tooth

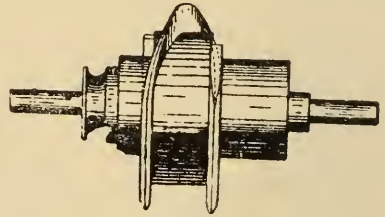

FIG. 124.

the next arm finds itself steadied against the regular surface of the "snail." A form of snail-motion was used very early by Wheatstone as a motive device, while the earliest intermittent motions, such as the Choreutoscope and Brown's apparatus of 1869, shown on page 46, employed pegs acting on slots placed either around the edge of a disc or along a rack.

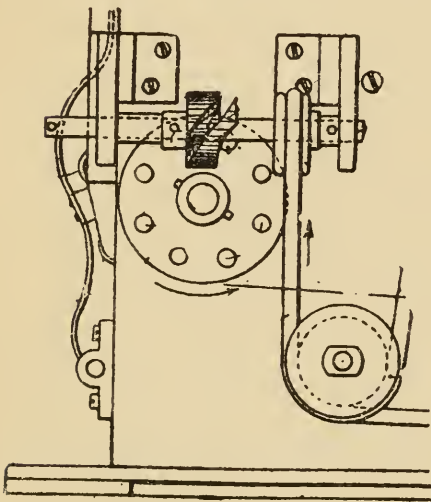

FIG. 125.



B3. *Film moved intermittently by raising and lowering sprocket-rollers.*

If the lower sprocket-roller maintains a fixed position and is continually rotating, it will of course continue to draw down film. If, however, it be mounted as shown in Fig. 127, the action on the film may be rendered intermittent although the sprocket-wheel does not cease revolving. The sprocket-axle is mounted eccentrically on a disc, the revolution of which consequently alternately raises and lowers the sprocket-wheel. This latter receives a rotary movement of its own through epicyclic gearing, and were its axle fixed, it would, as previously stated, draw the film down at a constant speed. The two movements are, however,

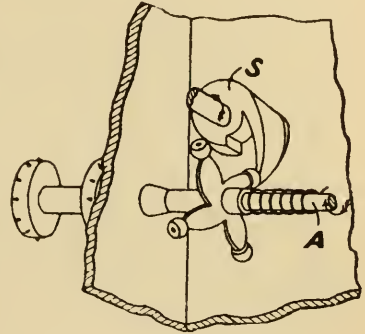

FIG. 126.

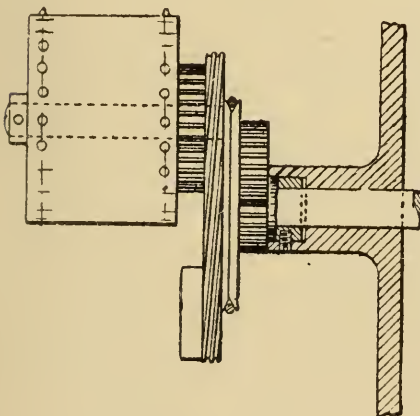

FIG. 127.

so proportioned that the roller rises along the film at the same rate as the sprocket-teeth rotate, and the wheel itself merely travels up the film. On the downward motion it not only rolls the film down in the ordinary way but also superadds a drawing action due to its fall. This device, so similar to Demeny's unworkable eccentric bobbin (Fig. 81), is employed in the Prestwich camera, and serves as a good example of the manner in which an ineffective motion may be transformed into a thoroughly effective and reliable

instrument by careful mechanical treatment. The sprocket-roller, while receiving a motion of its own,

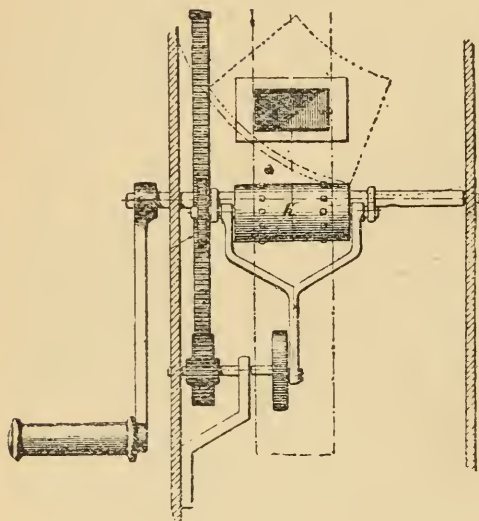

FIG. 128.

may be raised by a crank, as shown in Fig. 128, instead of by a direct eccentric motion applied to its axle. If, however, the sprocket-wheel does not receive a motion of its own, this movement forms a transition stage between rising-sprocket and claw-motion. The wheel seen in Fig. 129 rolls upwards

along the film, but is prevented from rotating in the reverse direction by a ratchet. On the down stroke of the crank-arm the wheel becomes fixed and acts exactly as a claw by drawing the film down.

#### B4. *Film moved by roller actuated by ratchet-gear.*

The first use of ratchet-gear appears to have been in Heyl's 1870 machine, described on page 47, but this apparatus was of very primitive type, a separate hand-pressure being required for every movement of the disc. Fig. 130 shows a ratchet-wheel (of course placed on the same axle as the sprocket-roller). A spring-pawl is jointed on the end of a crank-rod reciprocated by an eccentric. Every time the rod moves forward the spring-tooth pushes the wheel round; when the rod retreats, the tooth drags over the curved surface until it drops into position behind a fresh ratchet. Meanwhile a spring-pawl at the top, set the reverse way, prevents any backward motion of the wheel. In another

form the ratchet-tooth, instead of being tied to the same centre as the disc, may be placed on a plate mounted loosely on the same axle. A spring-pawl may be seen in Fig. 131 holding the ratchet-wheel steady. A crank-rod worked by an eccentric swings the loose plate to and fro, and the pawl mounted on the plate drives the ratchet-wheel on by acting against a second set of teeth, lying underneath those fitting the steadying-pawl. It will be noticed that the steadying-pawl not only bears against the ratchet teeth but also locks into a little groove. From this groove it is lifted at the proper moment by a pin on the loose disc. This pin is shown black, and lies just against the curved spring of the other pawl. One other form may be described here, Fig. 132, in which the ratchet is not a motive device, but only serves as an escapement.

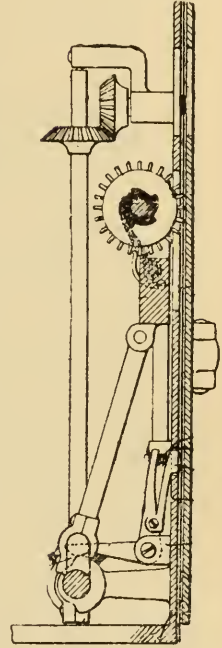

FIG. 129.

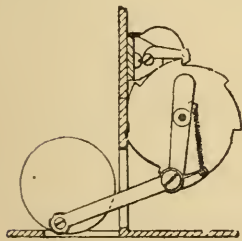

FIG. 130.

The sprocket-roller has a hollow axle, through which passes the spindle attached to the peculiarly shaped plate seen in front of the ratchet-wheel which is attached to the roller. This oval plate is in continual rotation, and so tightly drawn back against the ratchet-wheel that the two rotate together by friction. As seen in the drawing, however, a falling lever catches on a tooth of the ratchet-wheel and prevents it moving. As the front disc continues turning, the lever is lifted by one of the projections on the disc, thus freeing the ratchet-wheel, which then turns, being dragged round by the disc. But so soon as the projecting part

of the disc has passed, the lever falls, again locking the ratchet-wheel, and so renders the sprocket-roller and film stationary. It

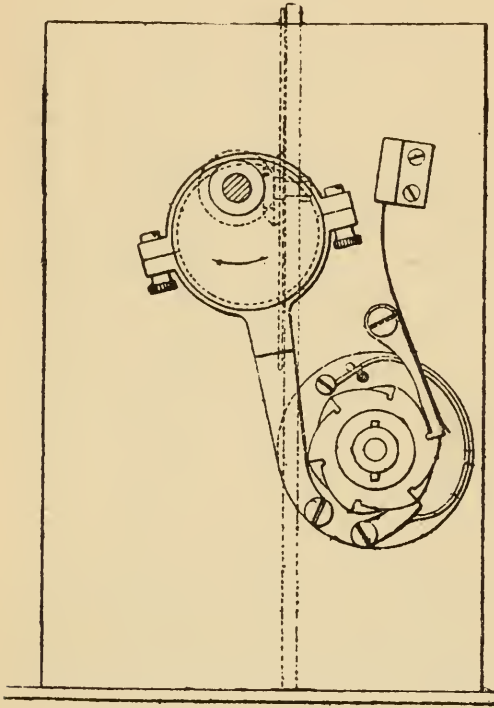

FIG. 131.

is clear that the front disc is not obliged to serve the double purpose of escape-cam and motor. If the sprocket-wheel be driven by a contained spring, the front disc need have no frictional action on the ratchet-wheel, but will only serve to lift the pawl and allow the ratchet-wheel to turn under the action of the spring as often as a cam-boss passes. In fact, this front disc

may take the exact form of a ratchet-wheel with the teeth set the other way, the curved back of the teeth acting as cams. The pawl will then be lifted as many times in a revolution as there are ratchet-teeth on the front disc.

*B5. Film moved by intermittent grip of two rollers.*

Two early methods of obtaining an intermittent motion from continually rotating rollers were suggested by Evans in 1890. One suggestion was that the rollers might be allowed to roll along the film for a time, thus leaving it stationary, and then be drawn back as shown in Fig. 70. Or the two rollers might periodically be held apart and only permitted to grip the film for a



sufficient time to draw a picture-length down. A simplification of this method is shown in Fig. 133, where two rollers are seen gripping the film between them and thus driving it onward. But it will be noticed that the left-hand roller is not of sufficient size to reach the film except in the part now acting. When this has passed there will be no grip on the film, which will remain stationary until the projecting part of the left-hand roller again comes round. Naturally this segmental piece exerting pressure on the film is so proportioned that its length is exactly equal to one picture. The Biograph works somewhat on this principle, but its details are so complicated that the machine must be described later on as a whole.

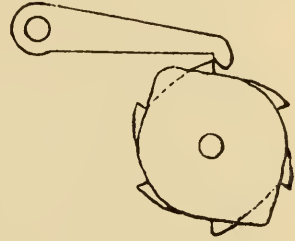

FIG. 132.

### C1. *Film moved by spring-teeth.*

In a degree the spring-fork used by Gray in 1895 (Figs. 88 and 89) was the forerunner of the spring-

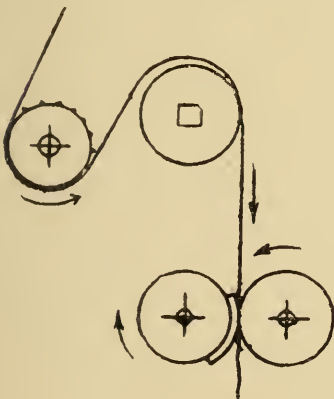

FIG. 133.

tooth, and in the same moderate degree a resemblance may be traced in the rising wheel governed by a ratchet which was shown in Fig. 129. In that arrangement the tooth acting on the film was able to travel over the film in one direction, and was fixed when moving the other way by the action of a ratchet-tooth, but this ratchet-tooth did not act

directly on the film. In the spring-claw, properly so-called, it does so. Fig. 134 may serve to explain the action, it being understood that this is a double-

action device, one spring-tooth serving to move the film and the other to steady it. H and  $d$  are two similar spring frames, but H is fixed while  $d$  slides up and down on a bearing, G. As shown, the tooth  $d^2$

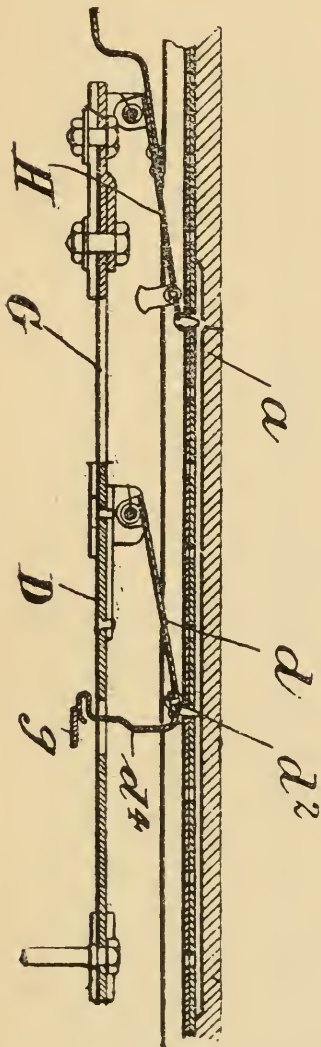

FIG. 134.

has just brought the film down and is momentarily at rest in order to steady the film, being pressed home by the stop  $g$ . Now, when the frame  $d$  begins to rise, so soon as it is free from the pressure of  $g$ , the tooth  $d^2$  will have no action on the film, but will drag over it as the spring part  $d$  yields a little. The friction of the tooth is prevented from shifting the film in the slightest degree by the action of the fixed spring-tooth attached to H. When D has arrived at the top of its stroke and begins its downward journey the tooth  $d^2$  falls into a film perforation and catches in it, driving the film down. Both the spring-teeth being set in a slightly downward sloping direction, the lower moving tooth has no tendency to slip out of the film, while the upper tooth allows the film to pass freely.

Fig. 135 shows another arrangement of this description. A little frame slides up and down behind the film. On this frame two little pawls, of the shape shown in the right-hand drawing, are pivoted and pass through the frame, being pressed into

contact with the film by the springs F. On the upward journey the upper slanting surface of the tooth drags over the film, the whole pawl being pressed back against the spring. On the downward travel the spring presses the tooth into a perforation, and the film being in contact with the straight under-edge of the tooth, the latter has no tendency to leave the perforation.

*C2. Film moved by teeth mechanically inserted and withdrawn (so-called claw).*

This claw principle has been fully described in conjunction with Lumière's Cinématographe (page 95), and therefore only a few modifications need be mentioned. For instance, the frame bearing the pegs may move up and down by means exactly similar to those shown in Fig. 93. But instead of being pushed in and out of the film perforations by wedges on rotating arms, a little rod may be carried backwards from the frame carrying the pins. This little rod has a bent head, which enters a groove on the edge of a disc (Fig. 136). Imagine this head to be in the position *o*, and the pegs will be held forward so long as the groove runs parallel with the front edge of the disc, and if the frame is sinking at the same time, the film will be pulled down. When the pegs arrive at the bottom of their stroke, the inclined portion of the cam-groove arrives at the position *o*, the rod connected with the pegs is drawn back the width of the edge of the disc, and the pegs are consequently withdrawn from the film, which remains stationary while the frame is rising and until such time as a reverse

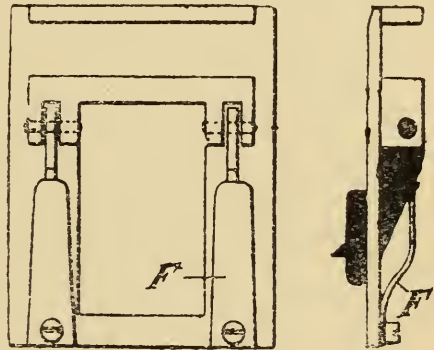

FIG. 135.

motion of the rod is caused by an opposite inclination of the cam-groove. Again, if the frame with the pegs were continually pressed back by a spring, the front side of the groove could be done away with, and the device would become a disc with variable surface, every bulge on which would drive the pegs forward into the perforations in opposition to the action of the spring. A cam-groove may be used for the double purpose of inserting the pins and also raising and



FIG. 136.

lowering them, as seen in Fig. 137. The pins are pressed back by a spring, *f*, and the stud *e* is consequently driven right home in the cam-groove of the revolving cylinder *a*. As this cylinder turns, the pin-frame will be drawn up and down, and the groove being made to vary in depth, the pins will be thrown further forward at one time than at another. This forward pressure is arranged to coincide with the downward course of the groove, which may also run straight for a short space when it is desired that the pins should be at rest. Or the head bearing the pins may be placed on the end of a suitably actuated lever, and rollers (Fig. 138) on the sides of this head may enter a D-shaped cam-groove (Fig. 139) in plates at the side. The head is therefore compelled to follow a definite path, the straight stroke of the D representing the period during which the pins are in the film and engaged in drawing it down. A kindred device

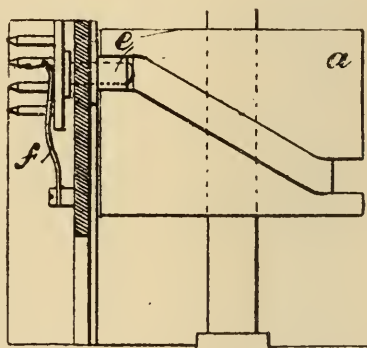

FIG. 137.

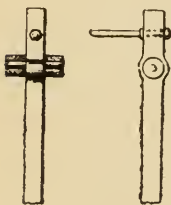

FIG. 138.

and engaged in drawing it down. A kindred device



which permits a variation between the periods of rest and motion imparted to the film is so ingenious that an attempt must be made to describe it, despite its complicated nature. The pins are carried on the head of a lever working about a swinging fulcrum, shown black in the centre of Fig. 140. This lever receives its motion from an eccentric pin on the disc 10 at top. If all parts were as shown in heavy lines, the points of the pins 17 would follow the outlined path shaped somewhat as an irregular D. But the fulcrum can be drawn back by the action of the eccentric 26, and when this is the case the pins will go through their evolutions without touching the film. Therefore, if the eccentric 26 makes a half-

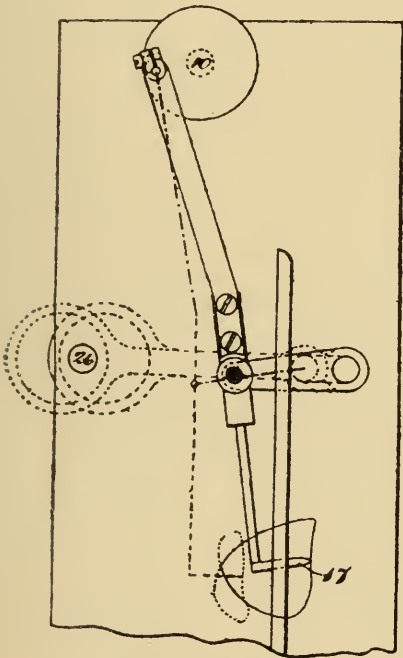

FIG. 140.

revolution to each turn of the disc 10, the pins will first describe the path shown in full lines and then retreat and follow the course of the dotted continuation, thus greatly increasing the period during which the film rests; and this period may be still further increased by increasing the difference in speed between the parts 10 and 26. One very compact apparatus causes a pin-plate, shaped as Fig. 141, to travel up and down a vertical rod, the plate being forced forward on to the film when necessary by the action of a cam-disc.

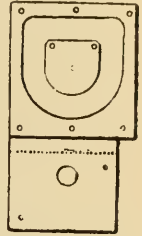

FIG. 139.

C3. *Film moved by gripping-blocks, etc.*

Pins and perforations are entirely done away with by the arrangement shown in Fig. 142. Two blocks,  $M^1$ , may be driven forward to grip the edges of the film against a plate on the other side. The gripping-blocks and plate then sink together, carrying the film with them. Flexible guards,  $M^8$ , prevent the film buckling, and when the pressure of the grippers ceases a brake-pad,  $Q$ , comes into action and clamps the film while the grippers rise.



FIG. 141.

D1. *Film intermittently struck by revolving eccentric.*

The original so-called dog-motion invented by Demeny was shown in Fig. 82, and Jenkins' application of the same is described in connection with Fig. 114. Only one modification needs attention here, and that is a means for varying the extent of stroke. The general principles of all dog-motions are well exemplified in Fig. 143. The film is steadied in front of the aperture by small pressure-rollers and plush pads. The two lower rollers are

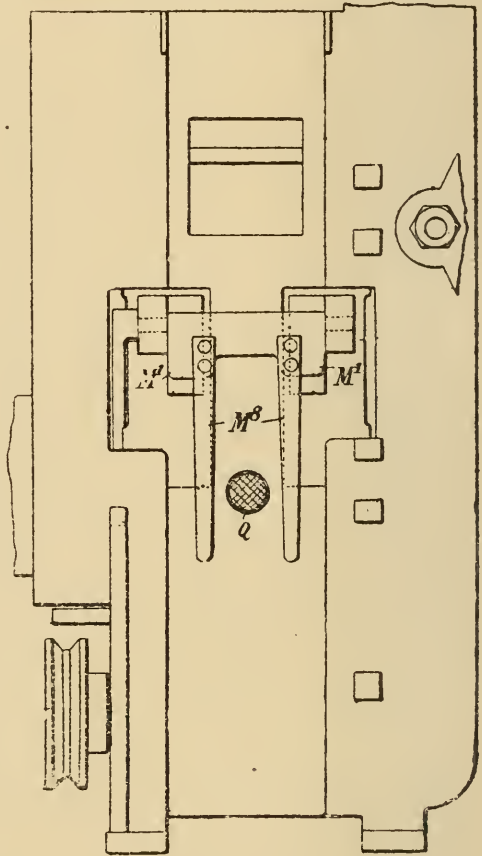

FIG. 142.

continually pulling at the film, and at the end of an exposure the film lies in a straight line between them and the pressure-frame. An interposed disc bears an eccentric rod, which strikes the film once in a revolution and draws some film down. It will be seen that for a fixed position of the disc the amount of film drawn on will depend on the distance over which the dog travels in contact with the film, and this is adjustable by shifting the dog along a slot on the disc. On the other hand, the relation between the periods during which the film is moving and stationary is governed by the number of degrees (i.e. the proportion of a revolution) during which the dog touches the film. If, therefore, the disc be made larger and its centre removed to a greater distance from the film, the dog will bring down an equal quantity of film in a less time, leaving the film stationary for a longer period.

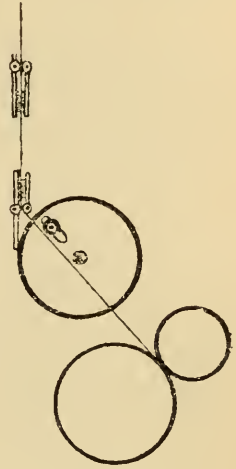

FIG. 143.

D2. *Film moved intermittently by reciprocated roller, etc.*

The roller which strikes the film need not have a rotary action, though that is perhaps the best form, there being no dead point. Evans in 1890 showed a double tilting-arm applied to this purpose (see Figs. 71 and 72), while Varley almost simultaneously invented a cam-reciprocated arm (Fig. 73). Both these actions took place over an arc; but Fig. 144 shows a crank-rod driving a roller in a line at right angles in order to loop the film. Blair has suggested a machine having a rise-and-fall shutter instead of one according to the ordinary type; and his drawings show the roller placed on top of

the shutter, which takes the place of the crank-rod last described.

D3. *Spring arm acting on film when clamp is withdrawn.*

This type of machine has already been fully described in connection with Figs. 74, 97, and 106. The earliest form suffered from the fact that the spring-blade had a period of vibration dependent on its length, and this period seldom coincided with the rate at which the views were being taken. This defect was overcome in the later machines by the interposition of some weighty parts, which destroyed the vibration due to the spring.

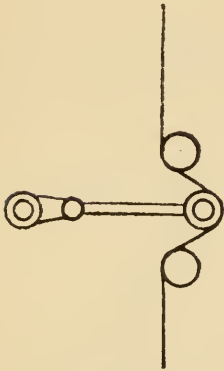

FIG. 144.

If the reader has had patience enough to follow out the preceding rough outline of mechanical methods for obtaining intermittence, he will probably agree that there appears to be little room for the introduction of new principles. Yet these descriptions have been only outline; the illustrations but diagrams. The extreme accuracy demanded in all these motions, together with the necessity of moving the film at a high speed and yet stopping and starting it many times in each second, renders a large number of mechanical refinements necessary. If it be permissible to express a personal opinion, it may be suggested that the best form of machine is that in which all parts (naturally excepting the film) are kept in continual rotation, thus avoiding any wearing pressure on the elements of the apparatus. If intermittently acting parts are employed, the workmanship must be of the best and the material such as will stand continued friction and shock without perceptible wear. Further, whatever the nature of the



mechanism employed, it should, for the safety of the film, apply tractive force gradually, and distribute that force over as large an area of film as possible. Thus in dog-motion machines the size of the dog is of great importance; the larger it is, the larger also the area of the film over which the blow is distributed. If the strain takes place on the sprocket-roller, the film should be kept in contact with it as much as possible, so as to share the pull over a maximum number of perforations. These considerations are elementary; grant them to have been satisfactorily applied, and it will still be conceded that no machine can be so perfect but that some compensating devices are necessary. To attempt the systematic description of these arrangements would be a hopeless task, they are so bound up with the general build of the machine in which they appear. Variations in driving power may be met by interposing a spring, as in Greene and Evans' machine; the driving-band itself may be a spring, or adapted to slip when resistance over a certain point is met with, or the driving pulley may slip instead. If no sprockets are used, the mechanism which drives the film may slip over the surface of the latter; in fact, the method adopted is a matter entirely subordinated to the general features of the machine. So also, if the film creeps and the picture varies its position on the screen, a little shield may be kept in motion to outline the picture and disguise its movement. Or in various ways an extra movement may be imparted to the film itself, as will be seen to a notable extent in the description of the Biograph. In fact, all these refinements are better explained in connection with actual machines; and they, together with such special considerations as double projection, showing ordinary views alternately with living pictures, and exhibiting appliances in general, will be found distributed through the following pages. Therefore,

after this short digression, let us proceed with a review of present-day machines, noting so far as possible all typical apparatus, and also such curious suggestions as obtrude themselves on our notice. It is not possible to give more than a general idea of these present-day machines and ideas, for not only is space limited, but in some instances the makers' courtesy has not permitted illustration, while in a few cases even description has been objected to.

“WARWICK BIOSCOPE.”

In describing this machine it must be mentioned that illustrations of the very latest design are not yet available, but views of last season's pattern will serve to

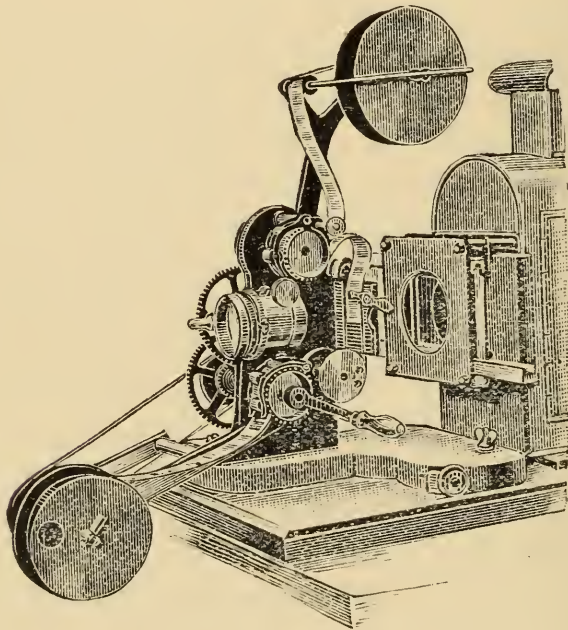

FIG. 145.

show the general character of the apparatus, the added improvements consisting in further refinements in detail, luxuries small in appearance but of great

value in practical working. The machine is of the dog variety, the dog being mounted between two guide-plates, and standing to the right of the lower sprocket-wheel attached to the handle. The film is drawn off the upper spool by a sprocket-wheel, which is geared to turn at exactly the same rate as the lower one. In the illustration (Fig. 145) this upper sprocket has just fed out a picture-length, which stands in a loop above the "film-trap," ready to be drawn down by the next stroke of the dog. The loop drawn down by the latter is continuously stored away on the bottom spool or automatic take-up, which is so geared that it winds up the film under even tension, despite increased diameter in course of working. The "film-trap" or "gate" which serves to steady the film in front of the lens is usually faced with velvet pads, and, despite the utmost care, dust is apt to be retained in the velvet pile, and even under the lightest pressure causes damage to the film, which passes through at an extremely rapid rate. In this season's Bioscope, therefore, velvet is entirely discarded, being replaced by small springs of special form, which bear very lightly on the edges only of the film. In this manner friction on the picture-bearing surface of the film is entirely done away with. The dog is so geared as to leave the picture at rest for a period eight times as long as that occupied in changing. With the majority of views this rapidity enables a shutter to be dispensed with, but in subjects having strong high-lights a rainy effect may be produced, while in a picture having little shadow the amount of light reaching the screen may be sufficient to impair the brilliancy of the view. To meet these contingencies an adjustable shutter is provided, shaped as a four-armed cross with narrow blades, each of which acts as a shutter. These arms are so narrow, and the shutter is so exactly placed at the most condensed portion of

the beam of light, that it fully effects its purpose without giving rise to perceptible flicker. The spool-standards are specially arranged with a reel-stop allowing rapid changing, and at the same time they will take spool-reels up to eleven inches diameter; that

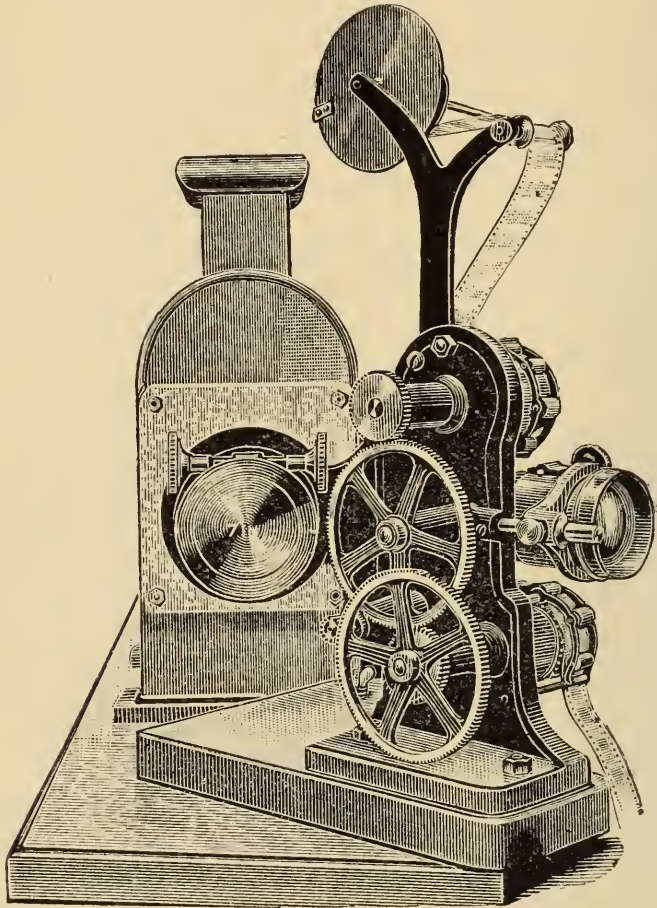

FIG. 146.

is to say, 1,000 feet of film may be placed on the machine in one length. Indeed, even larger spools may be arranged for, up to 2,000 feet capacity; and the "Bioscope Camera" will accommodate an equal length, a fact which enables a continuous scene of thirty minutes' duration to be projected. One other point is.



illustrated in Fig. 146. It will be seen that the base of the Bioscope itself is pivoted on the base-board of the lantern, and its framework bears two projection lenses. When the machine is turned aside in order to change a film, the other lens (suitable for ordinary projection) is automatically brought into position, and lantern-slides inserted in the usual carrier may be shown in the interval without any of those awkward pauses which tend so much to distract and dissatisfy the average audience. The accessories to this machine will be described in a later chapter.

#### CASLER'S MUTOGRAPH AND BIOGRAPH.

These two machines are best known by their magnificent results exhibited at the "Palace." The Mutograph, shown in Fig. 147, is the recording instrument; similar working parts with the necessary modifications being employed in the Biograph, which serves for projection. This giant among cinematographs is driven electrically, and its speed controlled by the same means. The film employed is  $2\frac{3}{4}$  inches in width, the pictures themselves measuring about 2 by  $2\frac{1}{2}$  inches. The results are, of course, characterised by increased detail, but the greater size of the film and its consequent enormous speed necessitate the employment of very different devices to those in general use. Rigidity is obtained by the massive construction shown in the illustration, and equality of speed by the use of electricity as a motive power. The interior details will perhaps be best understood by reference to Casler's Patent of 1897. The feed is given by the intermittent grip of two rollers, 41 and 42, situated just below the lens in Fig. 148. The roller 41 is covered with felt; the roller 42 has a portion of its face of sufficient diameter to grip the film, the rest being smaller and therefore allowing the film to

hang free of pressure. This action is similar to that shown in Fig 133, but the gripping surface of roller 42 is not designed to draw down an exact picture-length; on the contrary, it is so proportioned as to tend to draw down somewhat more than one picture. But only sufficient film for one picture is fed out by the roller 14, and therefore the gripping-rollers slip when an exact picture-length has been drawn. Further, in order that

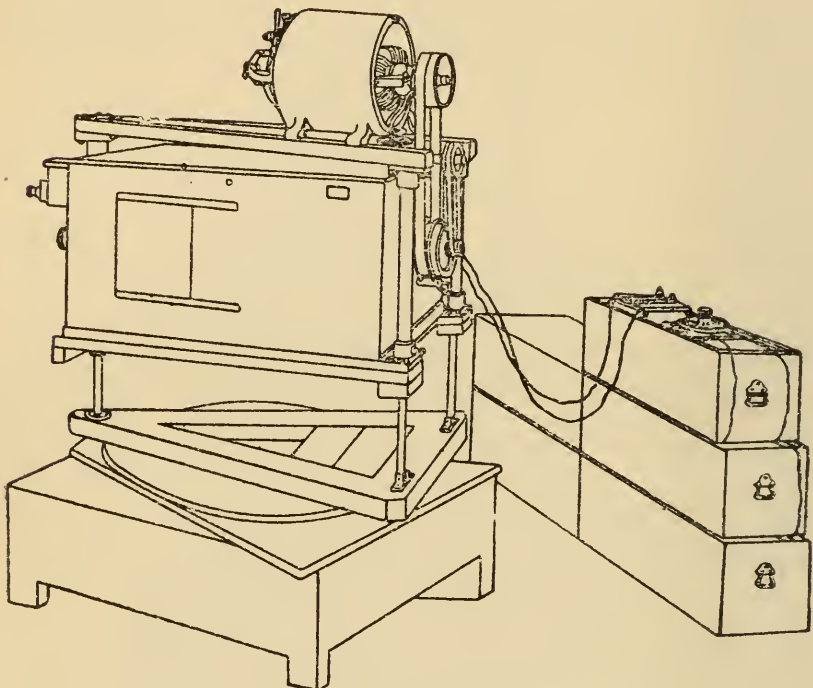

FIG. 147.

the film may be paid out and taken up at the same rate, the feeding-roller is not in direct contact with the film, which is gripped against an interposed band. This band is endless, and is also passed round the roller 22, which feeds the take-up spool. Now as this band is endless, if the speed of the feed-roller 14 is increased, so also is that of the take-up roller 22, for the endless band passes round both, and is in contact with the film at both points. A further means of regulation

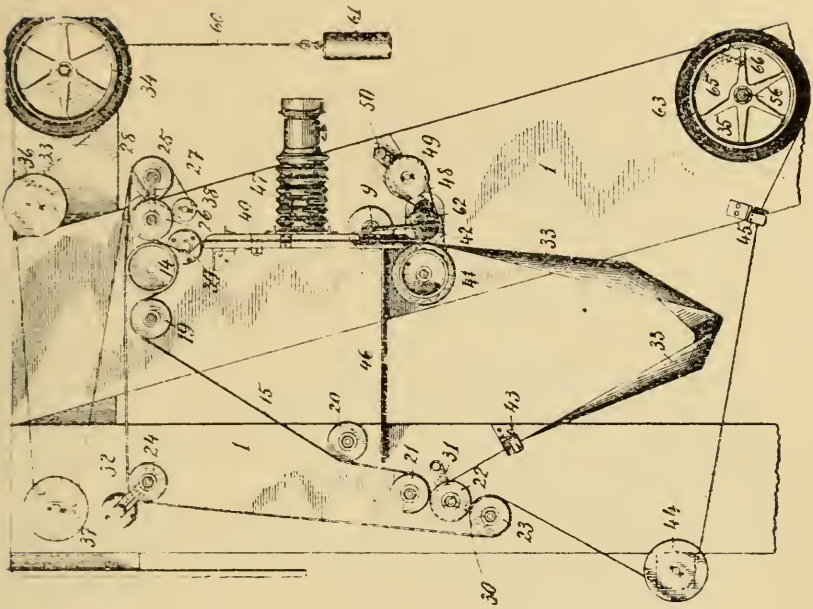

FIG. 148.

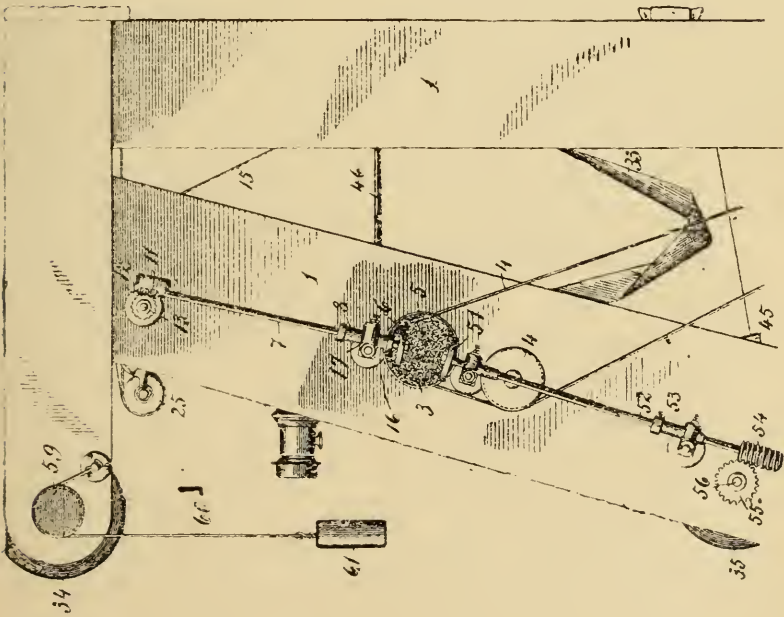

FIG. 149.

exists in the auxiliary feeding-mechanism shown in Fig. 149, the description of which must be read in conjunction with Fig. 148.

Gripping-roller 42 is understood to be the driving element of the intermittent feeding-mechanism, being mounted upon the main driving shaft. The take-up reel 35 is driven from the main shaft and friction-disc 5 mounted thereon by means of the friction-wheel 51, mounted upon a shaft 52, revolvably mounted, and arranged to slide up and down in a sleeve 53. At the lower end of this shaft is a worm 54 meshing with a worm-wheel 55 upon the shaft 56, upon which shaft the take-up reel 35 is mounted. When the friction-disc 5 rotates, this movement is communicated to the reel 35 through the shaft 52 and worm-gear, the weight of the shaft 52 and parts thereon holding it at practically its greatest distance from the centre of the disc 5. But when the film 33 is drawn taut the reel 35 can rotate only at the speed at which the film is fed to it, and since, when the friction-wheel 51 is at its greatest distance from the centre of the disc 5, it tends to rotate the reel 35 at a much greater speed than that at which the film is fed by the feeding-mechanism, as soon as the film becomes taut the speed of the film becomes less than the speed at which the wheel 51 tends to drive it, and the worm 54 climbs upon the gear 55, so raising the friction-wheel 51 until the speed of the take-up reel is adjusted to the speed at which the film is delivered to it by the take-off mechanism 22. As the film is wound upon the reel 35, the diameter of this reel gradually increases; but as it does so the shaft 52 gradually rises so as to keep the peripheral speed of the outside layer of film upon the reel 35 the same as the speed at which the film is delivered to the reel. From this description it will be seen that the machine is absolutely capable of automatically



regulating the speed of the respective parts. For every turn of the gripping-roller 42 on the main shaft an exact picture-length is fed out by the roller 14, and the taking-up spool regulates its own speed to suit the amount of film reaching it. When used for projection, the distance between picture-centres may not be constant, owing to shrinkage; for instance, 100 grips of the feeding-roller may draw down 101 pictures, which would result in the picture gradually creeping across the screen in a vertical direction; when fifty grips had been given, there would be the top half of one picture and the bottom half of another visible. But this is provided against by means of a regulating-screw, 17 (Fig. 149). If the band is travelling too quickly, a slight touch lowers the shaft 7, and the friction-disc 6 is therefore driven more slowly. The feed is thus decreased, and the take-up follows suit of its own accord, as previously explained. This description may be considered somewhat lengthy, but the unique methods of compensation employed do not lend themselves to brief explanation. There is no doubt about the magnificent results attained by this instrument, but it is evident that the perfection of the mechanism demands extreme ability on the part of the operator. It may be mentioned that the pictures shown in the Mutoscope (see page 37) are two-diameter enlargements from negatives obtained by means of the Mutograph.

#### HUGHES' MACHINES.

Among the earliest machines placed on the English market were the Moto-Photoscope Projector (with eccentric intermittent motion) and the Moto-Bijou Camera (a rising-sprocket apparatus). Naturally enough, the lifelong experience in lantern work of Mr. W. C. Hughes, coupled with two years' continuous

experiment, have enabled him to produce a vastly superior machine, superseding

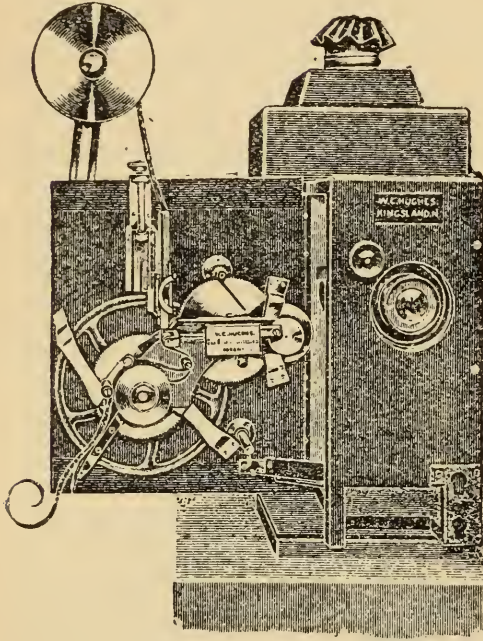

FIG. 150.

to produce a vastly superior machine, superseding the earlier patterns, which therefore need not be described in detail. The Motor-Pictoscope, as the new apparatus is called, carries all the working parts on the inner side of a door, as seen in Fig. 150. The essential mechanism is shown diagrammatically in elevation, Fig. 151, and plan, Fig. 152. It consists in a little frame,  $G^1$ , carrying a small roller,  $G^2$ , driven backwards and forwards by a rod,  $F^1$ , working from an eccentric seen on the right in the first Figure. Every rotation of the handle causes this frame to advance and retreat fifteen times, and on every one of these forward movements the roller  $G^2$  drives the film forward as seen in Fig. 151, drawing down exactly one picture. This motion, though rapid, is not of the nature of a sudden stroke, but is rather a nicely graduated pressure applied with due regard to the safety of the film. This one

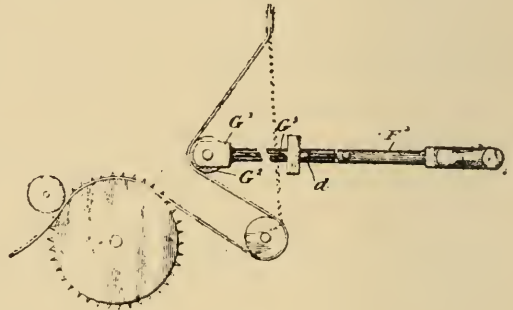

FIG. 151.

oscillating portion is constructed of aluminium, the low density of which renders the weight of so small a part practically negligible. So much for the essentials of the machine; good as the motion is, attention is unfailingly drawn from it to the precision and novelty of the accessory details.

For instance, when the two small pressure-rollers are raised from the sprocket-wheel, the latter is automatically locked—a feature

of considerable importance in correct and safe adjustment of new films. In the film-gate or cage which steadies the film before the lens the old form of pad is naturally discarded, for it is well recognised that pressure must be absent from the picture-surface; but

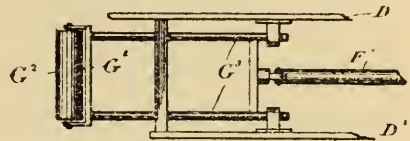

FIG. 152.

in this machine the film-edges, instead of being gripped through springs, are held by an ingenious triple flexible-pressure device, incapable of damaging a perforation, and almost as sensitive as human fingers themselves. The shifting screen or mask outlining the picture may be adjusted from outside by a special regulator,

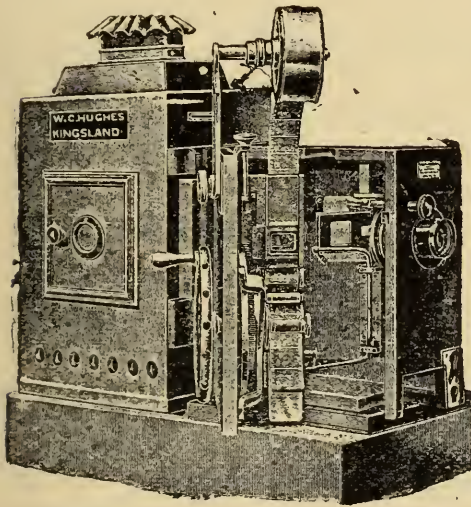

FIG. 153.

while a novel flap-shutter is provided (it will be seen edge-on geared from the same toothed-wheel which drives the eccentric), and it may be removed or placed in position practically instantaneously according to the character of the view under projection.



This shutter serves another purpose, or at least its use as a cut-off is rendered almost automatic. A glance at Fig. 153 will show that the exterior driving-wheel bears fifteen studs. When one of these is locked opposite a certain registering-stud, the shutter is in position to cut off all light from the film, thus complying with one of the most important County Council requirements. Inside the machine will be seen a small frame destined to carry single views or titles of small size. The act of opening the door to change a film throws this frame into exact position for projection by the same optical system employed for the animated views, the substitution taking place practically instantaneously. Safety in working is attained not only by the special shutter-action above referred to, and by an alum-trough in addition, but the lantern itself is so cased with mahogany and lined with asbestos, that it is practically impossible for a film to become damaged, let alone ignited through contact with a hot lantern body. Furthermore, brass spool-boxes are provided, so that the film is protected during the whole time that it is on the machine. Focussing and all operations except film-changing may be effected without opening the casing. Space hardly allows justice to be done to the remaining details—perfect balance of working parts and niceties of adjustment are poorly shown by mere engravings—but sufficient has been said to demonstrate the novelty of the apparatus, and the care with which it has been worked out. Mr. Hughes also makes the Photo-Rotoscope, a smaller apparatus designed for exhibitions on a reduced scale, and one accessory devoted to this end will be described in the chapter on Exhibiting Appliances.



## "ROSENBERG" CINEMATOGRAPH.

This apparatus employs a variable screw as shown in Fig. 124. The machine itself, in its commercial form, is illustrated in Fig. 154, the standard pattern being made for Edison-gauge films. The "gate" is shown open ready for the insertion of a film, outwardly bent projections serving as film-guides, and the gate itself being secured by a loose gravity-catch to diminish pressure on the film. The working parts

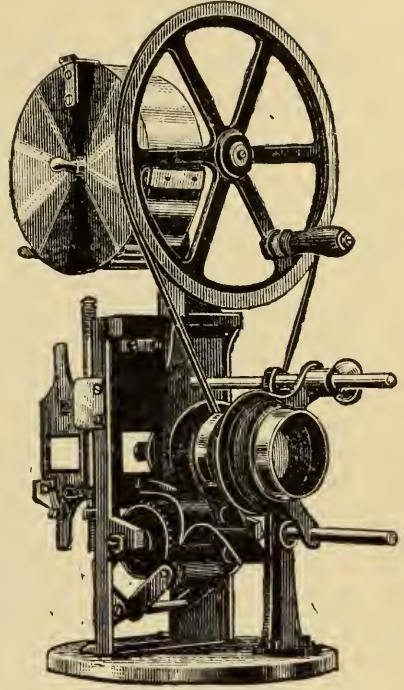

FIG. 154.

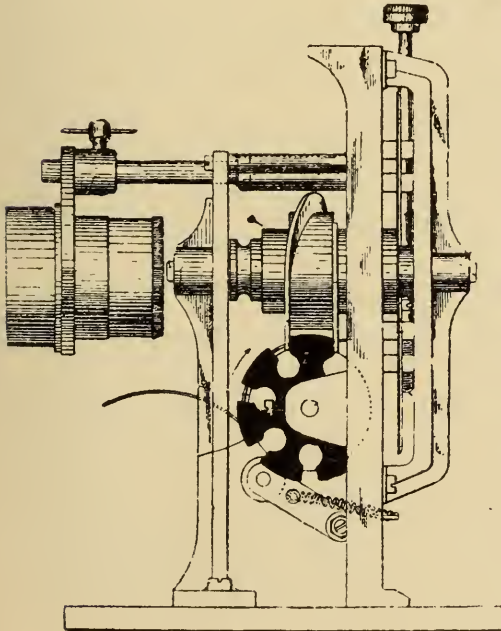

FIG. 155.

are better shown in Fig. 155, which is an elevation of the opposite side to that seen in the preceding figure. It exhibits the star-wheel attached to the sprocket-roller locked between the two straight portions of the driving-worm.

## MAREY'S LATEST CHRONOPHOTOGRAPHE. 1892

The improvements in this machine will be better understood after reference to the earlier form shown in Fig. 74. It will be remembered that the film was fixed by a clamp, the taking-up spool continuing to revolve. In order to provide film to feed this continual action, a spring-blade was interposed, and yielded in order to shorten the path of the film. When the clamp was taken off, the spring returned to its former position, and in so doing drew forward more film. This arrangement involved the spring making

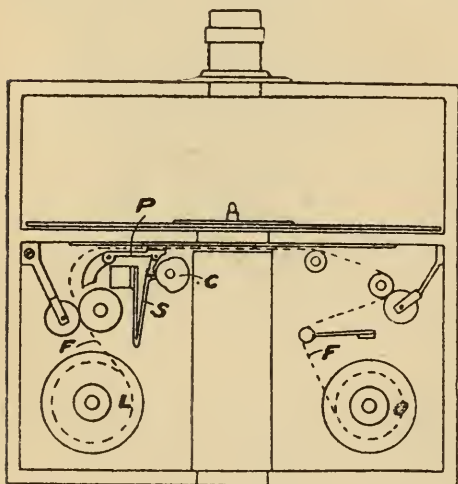

FIG. 156.

a certain number of vibrations per second, but the spring itself, by reason of its length, had a proper vibration, the rate of which very seldom coincided with the number of photographs secured in one second. Consequently the spring acted sometimes as a brake, sometimes as an accelerator, and thus rendered the spacing of the pictures irregular. Also the little spring clamp suffered from the same defect, thus intensifying the evil. A reference to Fig. 156 will show that the clamp *P* is now supported by a spring-frame, *S*, instead of by a vibrating blade. The star-cam is replaced by a single one, *C*, while a pair of rollers bear very lightly on the film before it reaches the tractive-spring *F* in order to destroy the momentum of the film. These modifications have rendered the machine perfectly effective in the matter of equal spacing.

## JOLY-NORMANDIN CINEMATOGRAPHS.

The two machines here described are the inventions of M. Joly, and constructed by M. Normandin. The simpler model is shown in Fig. 157, the intermittent mechanism being separately illustrated in enlarged form on the right. A heavy fly-wheel, F, is driven by gearing, and in one revolution

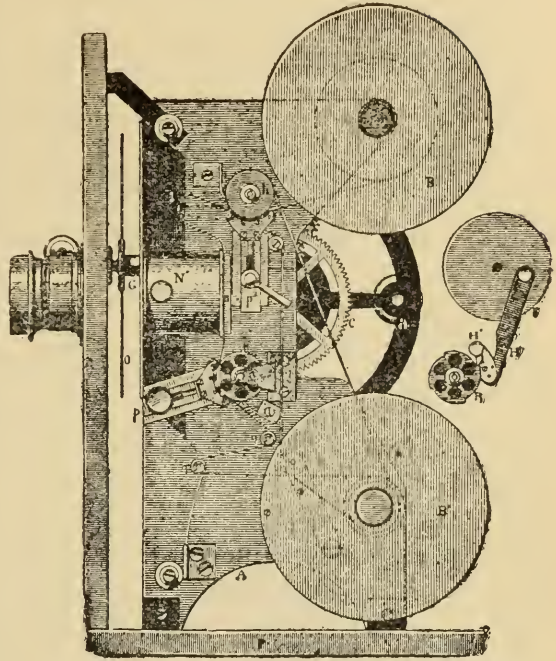

FIG. 157.

causes the pawl H' to move the ratchet-wheel R round to the extent of one-quarter of a revolution. This ratchet-wheel is directly connected to the same axle as the sprocket-wheel which drives the film. The linkage is so arranged that the ratchet-wheel is at rest three times as long as the period of motion. The larger machine shown in Figs. 158 and 159 is

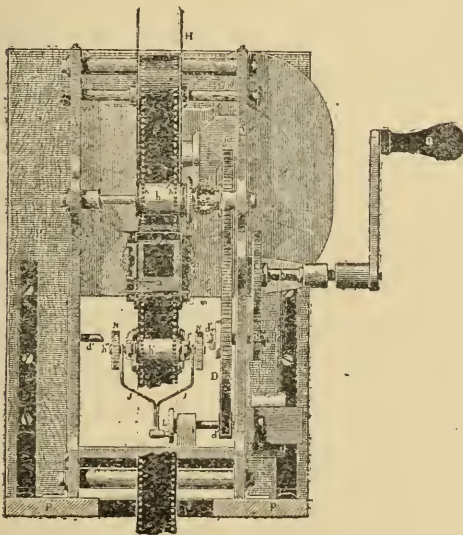

FIG. 158.



constructed to work on the principle illustrated in Fig. 128, a continually rotating sprocket-wheel being driven upward along the stationary film, which it

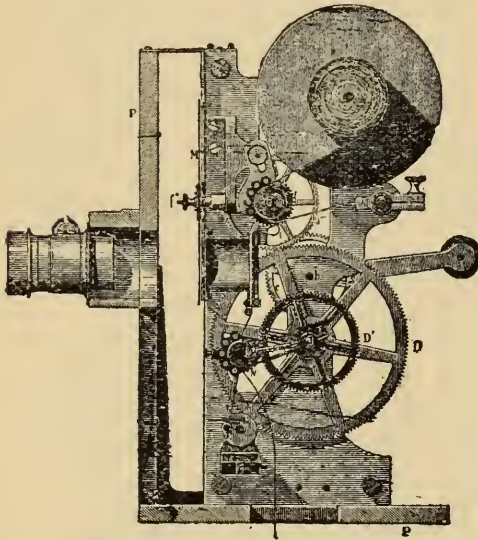

FIG. 159.

draws down rapidly on its return by reason of its fall and rotation combined. Fig. 158 shows the method of lifting the sprocket-roller by means of a crank-rod, while in Figure 159 the film will be seen pressed on to the sprockets by small pressure-rollers. In order that the lower sprocket-roller may be continuously driven by the wheel D', it is

swung from the same centre as the latter, and therefore rises and falls over an arc instead of vertically. M. E. Normandin is now bringing out an improved yet simple form of machine, to be called the "Royal Biograph," but details are not yet ready for publication.

#### MASKELYNE'S MUTAGRAPH.

This instrument is of interest not only from its great success at the Egyptian Hall, but also on account of the extreme ingenuity displayed in its construction. It is founded on purely optical principles, which had been dimly foreseen by Clerk-Maxwell (see page 26). The action is, moreover, identical in camera and projector. Unlike most machines, the film is in continual motion yet not momentarily viewed; for it is rendered optically stationary by means of the drum L<sup>1</sup>, composed of



concave lenses as seen in Fig. 160. The continuously moving film is caused to pass in front of a drum,  $L^1$ , which is geared with the film drums, so as to move with them, and this drum consists, in effect, of a series of lenses, say, concave, which are fixed edge to edge in a suitable frame. Inside the drum are placed two stationary lenses, in a frame  $M$ , in the line of the optical axis, the curvature of one or both of these lenses

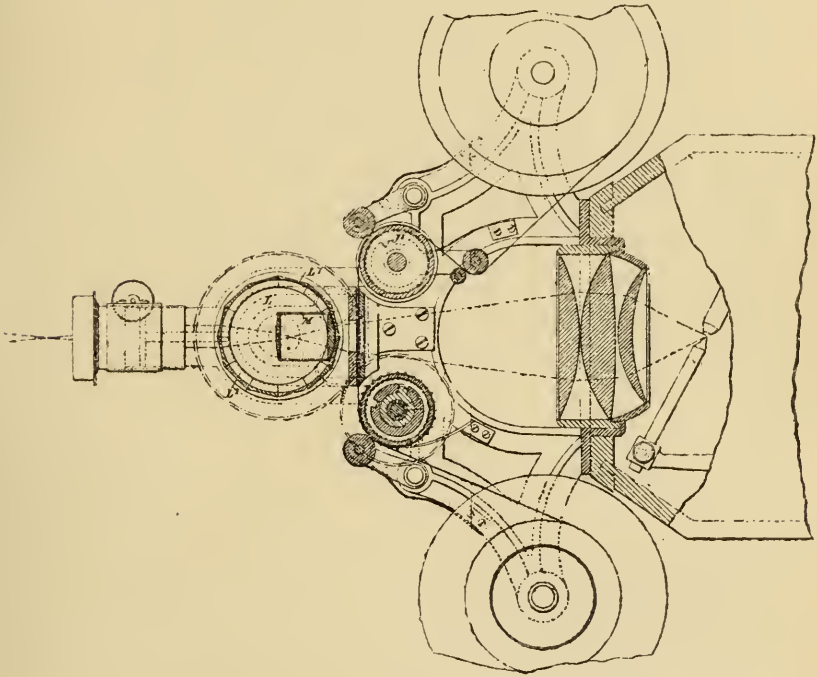

FIG. 160.

corresponding to that of the lenses on the drum. On the outside of the lens drum is the projecting lens or objective, while the source of light and the condenser are behind the film. The effect produced is as follows: Each successive picture on the film, in passing across the field of view, coincides with one of the lenses on the drum. The light passes through the picture on the film, thence through the corresponding lens nearest to it on the drum, the two fixed lenses, and the corre-

sponding lens on the other side of the drum, and then through the objective, reproducing the picture on the screen. When any particular picture is central with the optical axis, the faces of the various lenses will be parallel, and act as a piece of plain glass or a simple lens, and the light suffers no deviation from its course. As the parts move, the refracting surfaces change position, and the deviation thus introduced precisely compensates for the movement of the picture, and causes its image to remain stationary upon the screen. Means are provided for giving an independent motion to the sprocket-roller in order to accurately centre the film either at starting or during working. It was an instrument of this kind which was taken to India in order to secure a view of the late total eclipse of the sun; sad to say, the film disappeared on its journey home, and neither the Wizard of Piccadilly nor a reward of fifty pounds has yet succeeded in bringing the errant eclipse to light.

SKLADANOWSKY'S SERIES-APPARATUS.

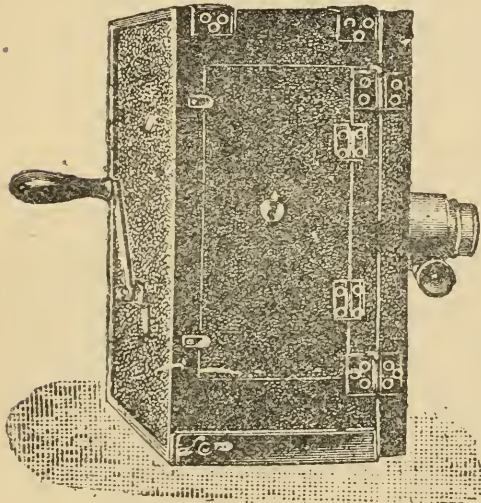

FIG. 161.

Herr Skladanowsky's patented form of intermittent device has already been described in connection with Fig. 113. The camera manufactured by him (Fig. 161), while suitable for all ordinary work, is specially recommended for obtaining living portraits. For this purpose a series of forty-eight to fifty-

views is sufficient, the positive prints being made on paper and bound in book form. The individual pictures measure 1·6 by 2 inches, and are taken on negative films 2·6 inches wide. One of these living portraits, bound in leather and inserted in a case to preserve the spring of the leaves, shows the German Emperor saluting. The effect is far better than the ordinary half-tone books, and indicates a new field of possibility in commercial portraiture. The same manufacturer issues a toy lantern using endless bands.

#### THE LAPIPOSCOPE.

Under this somewhat gruesome title is hidden the instrument whose working principles were described in connection with Fig. 132. That the inventor's name is Lapipe may be an explanation; it can hardly be an excuse. Fancy the dreadful compounds which might be evolved were this example generally followed! The build of the Lapiposcope is shown in Fig. 162, the shutter being of the segmental cylinder pattern.

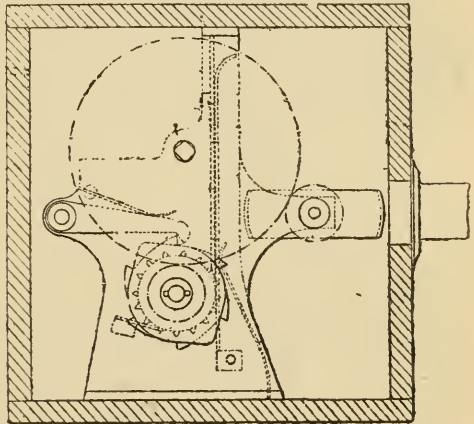

FIG. 162.

#### DEMENY'S "CHRONOPHOTOGRAPHE."

This apparatus, the essential features of which have been explained in connection with Figs. 82 and 83, is made by Gaumont et Cie., being known in England under the name of the Chronophotographer. Two sizes are made, the larger employing films 60 mm. wide, the

increased area of picture being of especial value when the views are destined for colouring. One of the most effective exhibitions with this machine was a reproduced ballet, whose delicate tints and effective

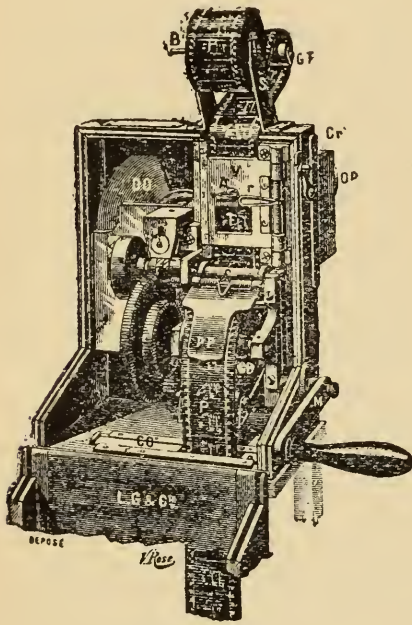

FIG. 163.

detail rendered it a thing of beauty, and a joy—if not “for ever,” at least for so long as the film should endure. Fig. 163 shows the Chronophotographe of 35 mm., i.e. ordinary gauge, arranged for projection. C is the eccentric rod which causes the intermittent movement, while CD is the sprocket-wheel, and DO the segmental shutter. When used as a camera, the apparatus is, of course, furnished with the necessary light-tight film-boxes, and weighs

under nine pounds. The first form issued was shown at the Paris Exhibition of Photography in 1892 as the Bioscope, its principles being the same as those of the Chronophotographe, but the arrangement of its parts somewhat different.

#### RIGG'S KINEMATOGRAPH.

Rigg's patent provided a variable screw-motion such as shown in Fig. 123. An arrangement was also employed whereby the tension of the film automatically withdrew a brake-block from the store-reel. So soon as the drawing action on the film ceased, the brake was automatically applied in order to neutralise the momentum of the store-reel.



## CASLER'S ANGULAR MIRROR.

In this apparatus (Fig. 164) a mirror is used to render the continuously moving film optically stationary. The film passes from the feed-roll 2 to the store-spool 3, in contact with the segmental frame 16, which has an opening, 27. This frame swings from right to left at the same speed as the film, and is so arranged that when starting on an oscillation a picture is outlined by

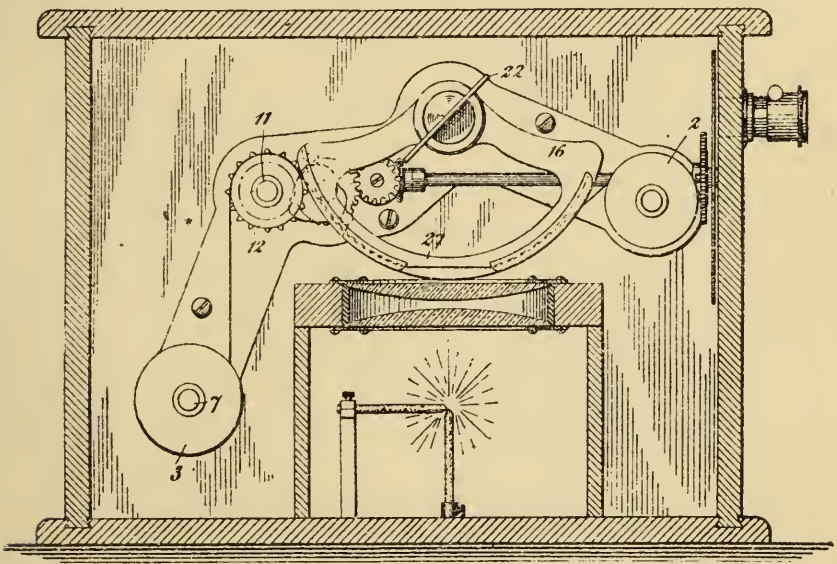

FIG. 164.

the opening. Light passes through this aperture, and the picture to the mirror, which is moved by gearing at half the angular speed of the frame; consequently the rays are maintained optically stationary with regard to the projection-lens. When the frame reaches the extreme of its movement to the left, both it and the mirror are rapidly returned to their original positions by means of cams.

## CAMPBELL'S MIRROR APPARATUS.

This machine (Steward and Frost's United States Patent No. 588,916) is shown in Fig. 165, and depends upon the same optical

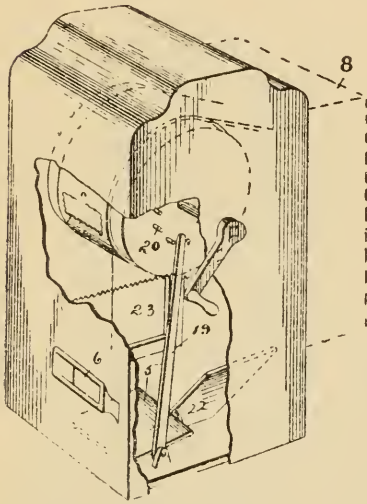

FIG. 165.

principles as the foregoing apparatus. The band runs over a drum, being drawn from a box, 8, and illuminated by means of a mirror, 22. As it is only designed for inspection purposes, the pictures are seen through magnifying eyepieces, 6, the rays being rendered optically stationary by means of a mirror, 5, tilted by means of a lever, 19, actuated by pegs, 20, on the drum. In addition,

it is suggested that the instrument may be employed (of course without the film) for the inspection of moving machinery, etc.

## ANTHONY'S "SPIRAL" LANTERN.

This apparatus may also be used as a camera; its arrangement as a lantern is shown in Fig. 166. More than two hundred pictures may be obtained, or projected from, a plate eight inches in diameter, and the general principles upon which these spiral cameras are worked will be better explained in connection with

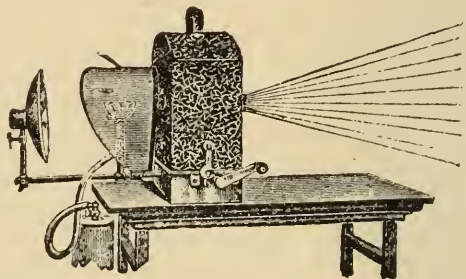

FIG. 166.

## NELSON'S "SPIRAL" CAMERA

(United States Patent No. 594,094). The plate is contained in a light-tight case (Fig. 167), having the lens midway on its vertical line. The plate may be moved from right to left across the lens by means of a screw on the driving-shaft, as seen in Fig. 168. At the same time it is intermittently rotated through the broken-screw K, and the

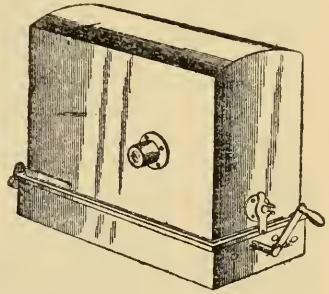

FIG. 167.

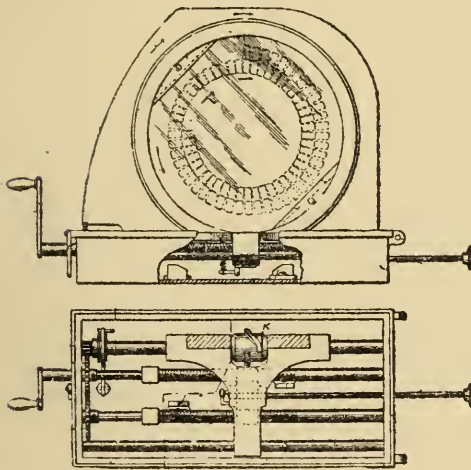

FIG. 168.

result of the combination of these two motions is the spiral disposition of the series of views on the plate. These series are somewhat short, but the preparation of a positive for projection purposes offers no more difficulty than does the making of an

ordinary lantern-slide; there is no shrinkage to consider, and the system therefore has its advantages for the occasional amateur's use.

## "MOTOGRAPH" MOVING PICTURE BOOK.

Though not exactly depending upon persistence of vision, this ingenious device (issued by Messrs. Bliss, Sands, and Co.) may well be mentioned here, its effect being secured by a novel application of an old principle. Every one, presumably, remembers the Lantern Chromotrope, the "twinkle, twinkle, little star," of earlier days.

The apparent motion of the Chromotrope is due to the intersection of curved coloured lines rotated in opposite directions. As these revolve, the point of intersection is removed either to or away from the edge of the screen, and this is the source of the apparent

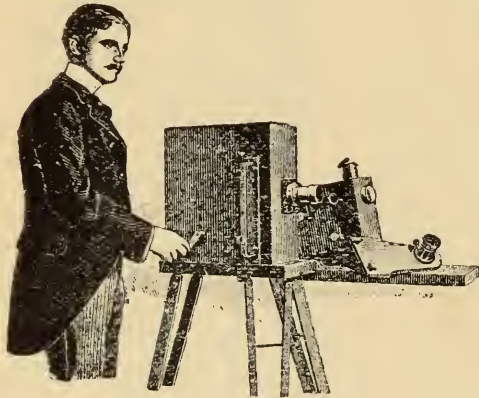

FIG. 169.

motion. In the Moving Picture Book engravings of a machine, volcano, or what not are printed with the shading lines very distinct, and running in definite directions. A transparent ruled screen is supplied with the book, and when this

is laid down on the engraving and given a certain motion, the intersections of all the ruled lines on the screen with the shading lines of the drawing are continually displaced, and give the effect of motion in a direction determined by the direction of the shading lines.

#### ANTHONY'S "BIOPTICON."

This instrument is made to accommodate 500 feet of film, and is illustrated in Fig. 169. Its arrangement for projection will be seen in Fig. 170.

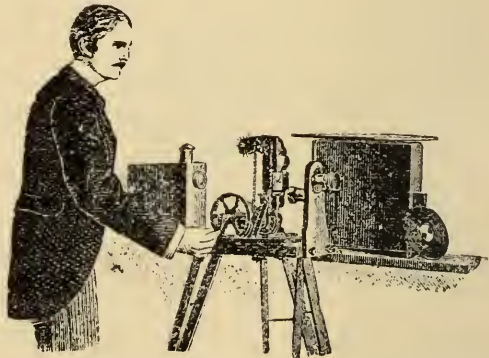

FIG. 170.



## PERRET AND LACROIX' HELIOCINEGRAPHE.

The intermittent motion is a snail escapement, similar to that shown in Fig. 126, and gives a period of illumination three times as great as that of eclipse. The apparatus is suitable both for photography and projection.

## THE "RATEAUGRAPH."

This apparatus, first named "Rateau's Chronophotograph," works on principles already explained in connection with Fig. 134.

In its latest form (Fig. 171) the acting spring-tooth  $n^3$  is carried at the end of a lever,  $n^1$ , tilted through the rocking motion imparted to N by the rotating cam-groove  $m$ . An arm,  $n^5$ , serves to steady the tooth against the stop O. The fixed spring-tooth is attached to the spring-arm Q. The film travels in contact with a perforated band, L, and the apparatus may be hand- or clockwork-driven. A pneumatic shutter-regulator is also shown. This apparatus is

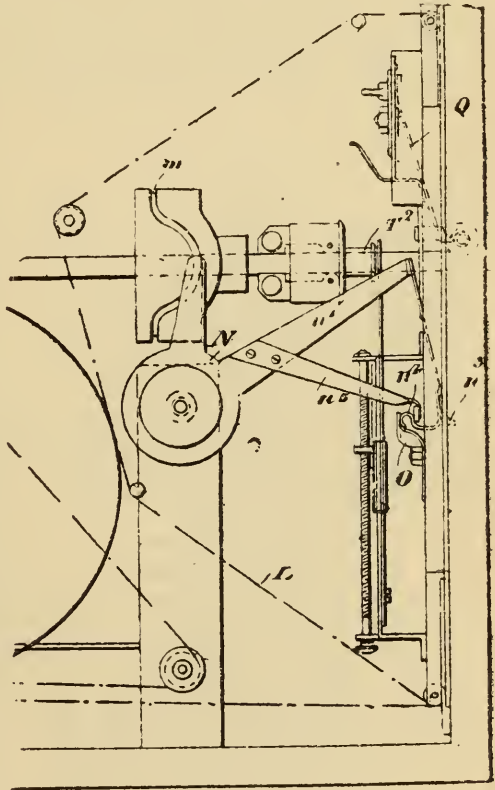

FIG. 171.

designed for producing pictures of the usual size, but in some negatives shown by the inventor the strip

had been worked sideways and the spacing doubled. This arrangement gives a picture  $1\frac{1}{2}$  in. by  $1\frac{1}{8}$  in., with the base-line to the side of the film, which is, however, of the usual size. The apparatus takes any gauge, English or French, but in the negatives above referred to the perforations are circular in sets of three *between* the pictures instead of on the margin.

#### WATSON'S MOTORGRAPH.

This apparatus actuates the film by means of a sprocket-roller containing a continuously wound spring. The sprocket-roller bears a ratchet, which is locked by a spring-pawl lifted at stated intervals by the action

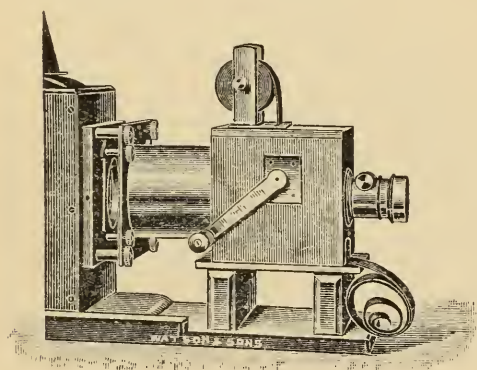

FIG. 172.

of a cam on the same axis which supplies power to the contained spring. A fair idea of this arrangement is given in Fig. 132. If employed as a camera, two spool-boxes take the place of the open spool and loose film seen in Fig. 172. The apparatus

is above all distinguished by its compactness. Its size is far less than that of many hand-cameras, and it also possesses the advantage of easy adaptability to any ordinary optical lantern.

#### MESSTER'S MACHINES.

These are constructed in various patterns, the simplest form of Kinetograph shown in Fig. 173 being intended for home use. The lighting is by oil, but

a safety-shutter to the condenser and also an alum-trough are provided, while another pattern provides also for the projection of ordinary slides. The Amateur-Kinetograph is of somewhat novel design, the usual pair of spool-boxes employed in camera-work being combined into one dark slide, as seen on the right in Fig. 174. The instrument itself stands on the left ready for projection work, and it will be noticed that the mechanism is frictionally driven from the large hand-wheel which

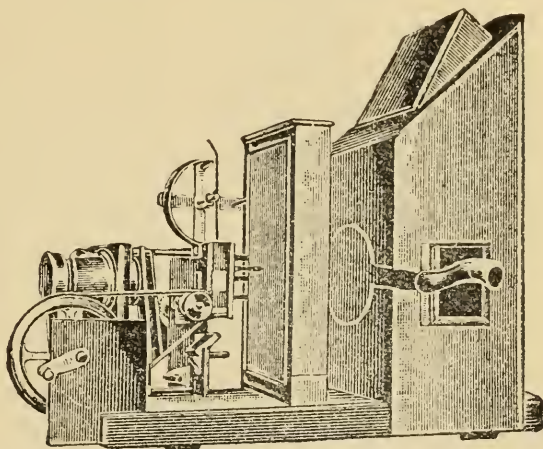

FIG. 173.

frictionally driven from the large hand-wheel which

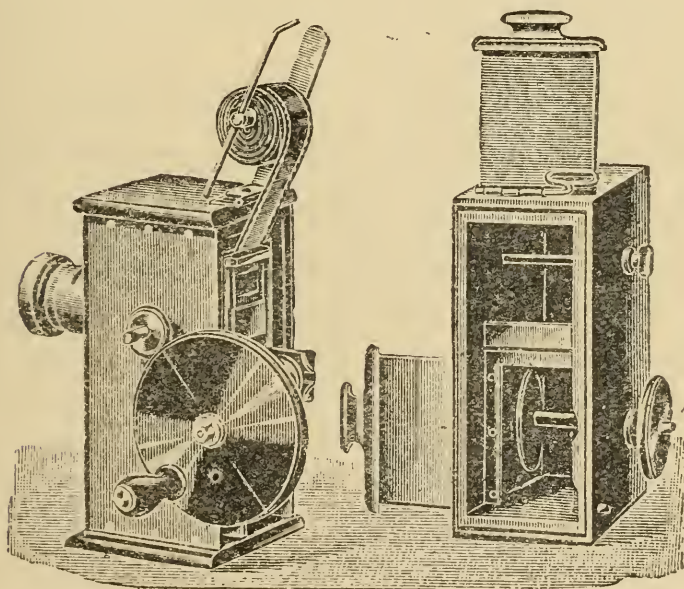

FIG. 174.

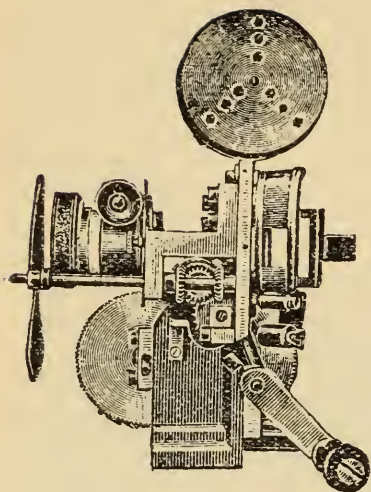

FIG. 175.

also drives the dark - slide spool when the two parts are coupled as a camera. Driving-bands are thus dispensed with. The *Thaumtograph* (Fig. 175) is a portable form for exhibitions, while the "Apollo" *Kinetograph* is of such massive build as to be best suited for permanent placing in public halls, etc.

#### MELIES AND REULOS' KINETOGRAPH.

This machine moves the film by mechanism shown in Fig. 125. It is supplied in two forms, the larger being electric-lit, the smaller serving rather for amateur use. A pair of light ebonite rollers press the film on to the sprocket-wheel, which is made of aluminium.

#### ACRES' DUPLICATE APPARATUS.

The camera (Fig. 176) is designed to procure a series of views by means of two lenses, such views being arranged on the film in the order 1, 3, 2, 4, 5, 7, 6, etc., the film behind one lens being moved during exposure with the other. The film is driven by two sprocket-rollers, A and A<sup>1</sup>, a loop being formed between them. A crank drives a double-toothed rack backwards and forwards, thus rotating the sprocket-rollers, which, however, can only turn in one direction, being prevented from moving backwards by a locking-ratchet. Thus in the illustration an exposure is proceeding with the left-hand lens. As the slide C moves to the right, the sprocket-roller A will not be moved, but A<sup>1</sup> will rotate



and draw the loop  $B^1$  behind the right-hand lens. So soon as exposure with this begins the rack moves back to the left, and now it is sprocket-roller  $A^1$  which remains still while  $A$  draws off more film from the loop  $B$  and at the same time passes on sufficient film to re-form the loop  $B^1$  between the lenses. It has already been pointed out that cameras having a double point of view must induce an apparent vibration of foreground objects on the screen by reason of the varying perspective of alternate

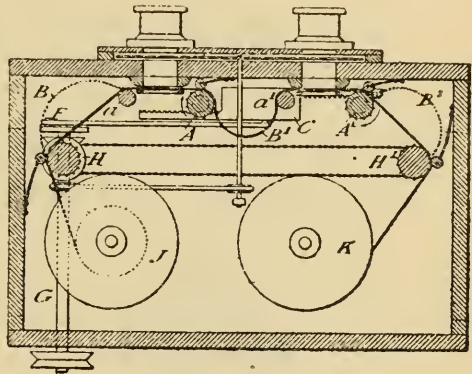

FIG. 176.

views, and, indeed, there appears to be little advantage in employing a duplicate system *for obtaining negatives* unless it be so arranged that both systems work through one objective, as in Fig. 86, or at least from one point of view. The great need is not that the views should be photographed without interval, but rather that they should be *projected* without intervening darkness; and this is perfectly feasible, for the separation of

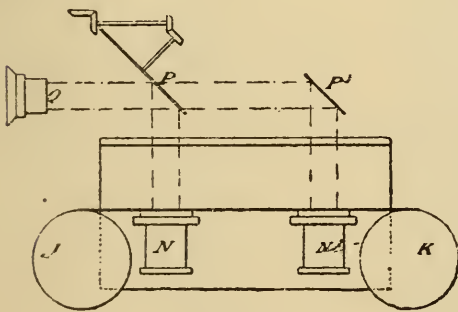

FIG. 177.

projection lenses does not alter perspective. Acres' duplicate projector is shown in Fig. 177, where a parallel beam of light from the lens  $Q$  either passes through the objective  $N^1$  by deflection from the mirror  $P^1$ , or is cut off by a rotating mirror,  $P$ , and transmitted

from N on principles the same as those explained in connection with Figs. 86 and 87. Of course the views must be in alternate order on the band, but such a positive may easily be obtained from an ordinary serial negative, as will be seen in the next chapter.

#### NEW LUMIERE CINEMATOGRAPHE.

The principles of the Cinématographe have been very fully discussed on pages 93-97; the latest form is shown in Fig. 178, lent by Messrs. Fuerst Brothers,

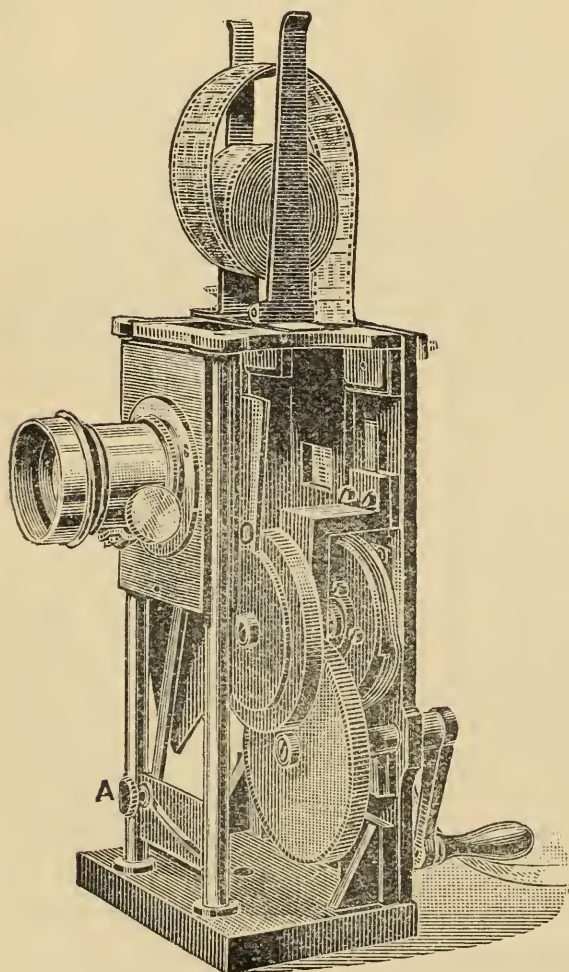

FIG. 178.

the English agents. It will be seen that the claw is actuated by a cam-disc instead of rotating arms, and in this way continual contact is ensured between the working parts; while every portion of the mechanism, of course excepting the claw, is kept in continual rotation. O is the shutter, and A a lever which controls the rising and falling lens-board. By means of this lever the lens may be

centred to the film in conjunction with the usual out-lining mask, and the position of the picture on the screen is therefore not disturbed. In the film-trap steel springs bear on the edges only of the film, and scratches are thus avoided.

#### PARNALAND'S SPRING-TOOTH.

The connecting-rods  $L'$ ,  $M$ , and  $L$  (Fig. 179) are driven by an eccentric, and serve to move a frame up

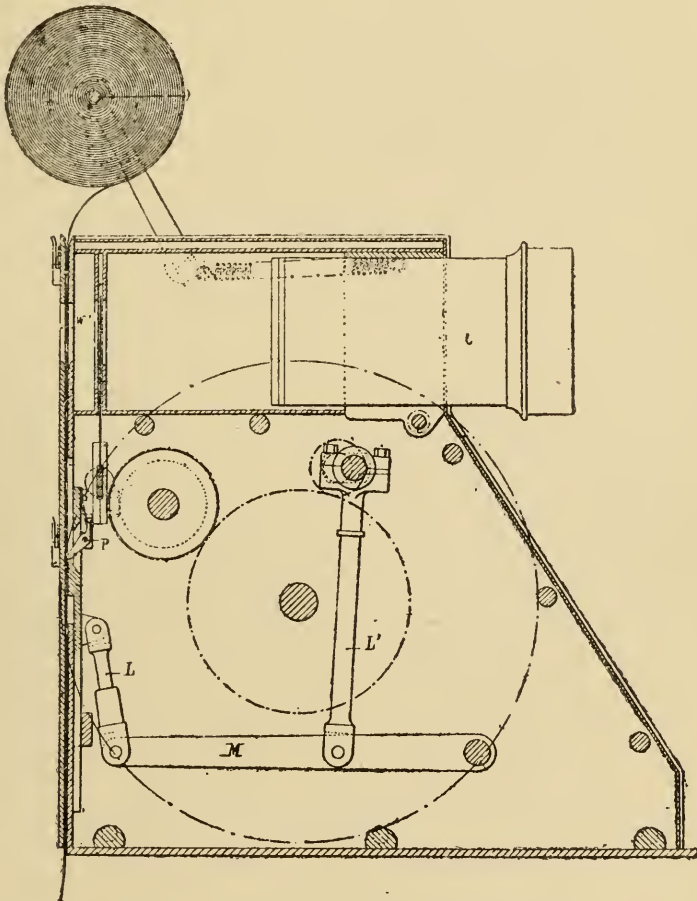

FIG. 179.

and down behind the film. This frame bears spring-teeth,  $P$ , which engage with the perforations, drawing

the film on the down-stroke and slipping over the film on the up-stroke.

#### NAISH AND CO.'S CINEMATOGRAPH.

This apparatus had a claw raised and lowered by a triangular eccentric. The claw was forced forward by a cam-disc, and returned from contact with the film by the same means. The light could be deflected through a vertical lens for ordinary projection.

#### KAISER'S KINETOGRAPH.

This apparatus is described as a modified Maltese-cross movement. The ends of the cross are hollowed, and another cross has convex ends which bear against the ends of the first to steady it. The second cross is carried on a rotating plate, which also bears the pins serving to actuate the first-mentioned cross.

#### THE SANSON CINECOSMORAMA.

No exact description of the commercial form of this instrument is available. Sanson's patent provides a ratchet-wheel periodically moved by a tappet. Another tappet-lever serves to take off a spring-pawl in order to allow the first-mentioned tappet to act. It has a segmental shutter. It is suggested that the instrument may be used for the production of moving scenery and living advertisements.

#### CANNEVAL'S CINEMATOGAPHE.

A claw-frame is driven up and down by a crank-motion, the oscillation of which also governs the insertion and withdrawal of the claw through the oscillation imparted to the frame itself, the pivot of which slides up and down in slots, the frame rocking against a fixed bearing-roller.



## LUBIN'S CINEOGRAPH.

This machine is shown in Fig. 180 arranged for the exhibition of an endless band which passes over upper spools, the slack being contained in an iron box swung under the stand. A special feature is the safety door made of isinglass, which it is claimed stops all heat-rays, and thus ensures perfect safety. Fig. 181 shows the apparatus

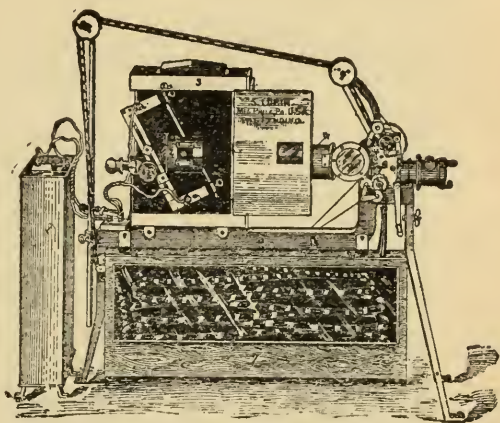

FIG. 180.

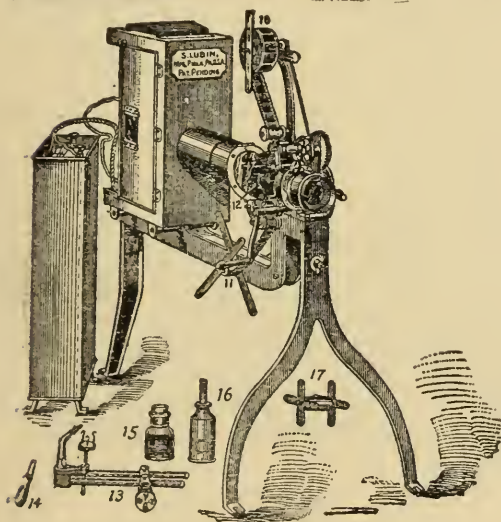

FIG. 181.

arranged for the use of spools in the ordinary way. A speed-regulator is also provided, together with a second optical system for the projection of ordinary views. The fact that patents are pending precludes detailed reference to many interesting features of this machine.

## THE MICROGRAPH.

This instrument, constructed by the Micrograph Co., is shown, so far as working parts are concerned, in Fig. 182. The film is led down from the spool-box

over the front surface of the main plate, through which the periphery of the sprocket-wheel projects at the bottom in order to engage with the film. The film-trap is shown open in the illustration; as it turns back on the film the small roller at the bottom holds the film

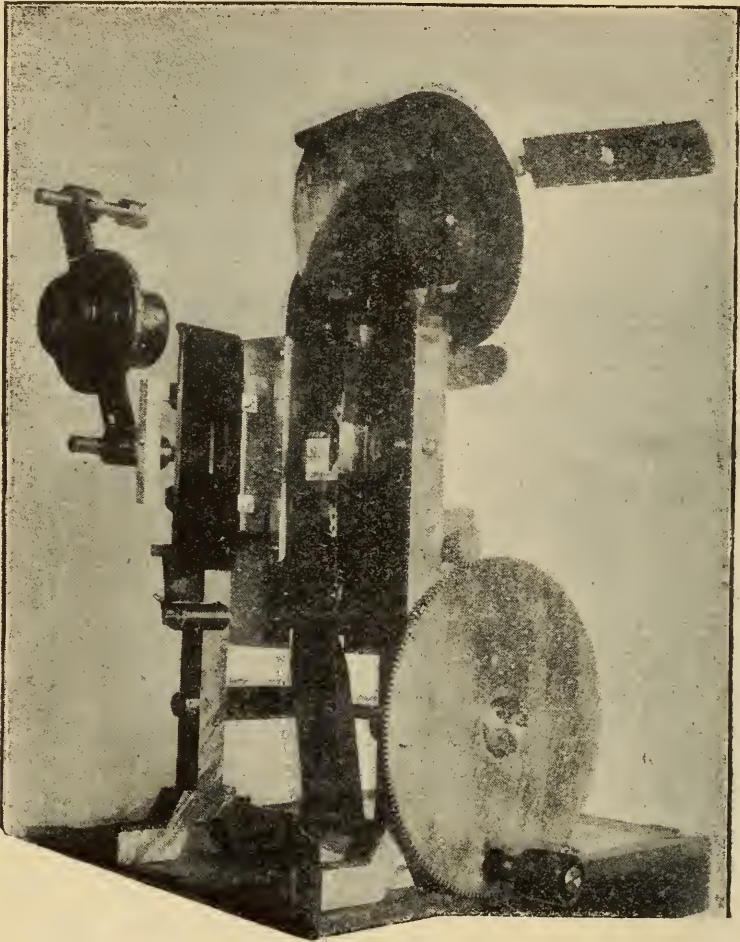

FIG. 182.

up to the sprockets. The sliding jacket carrying the lens is mounted on a transverse bar, which may be instantly thrown up out of the way for film-changing. The sprocket-wheel is actuated by a star-and-pin motion somewhat like Fig. 118, and it will be seen to be driven by toothed gearing direct from the driving-

wheel. The bar for closing the spool-case is shown thrown up; the small lever under the spool-box serves to adjust the mask. The mechanism as shown is mounted on a base-board, and behind it a sliding lantern-body may be adjusted at any desired distance. The lighting is either electric, with a very steady hand-feed lamp; acetylene, which finds considerable favour with the makers, or an incandescent burner served from the ordinary house-gas supply for home use. A form of this incandescent burner using vaporised benzene was introduced experimentally, but abandoned in favour of the other lamps mentioned above.

#### ZION'S MOUVEMENTOGRAPHE.

This apparatus has a star-wheel moved by a variable-pitch worm, and gives a period of illumination twice as great as that during which the shutter (which is made of mica) acts.

#### WRENCH'S "CINEMATOGRAPH."

This machine is open at one side and closed at the other by a shallow box, wherein are contained the essential members of the periodic driving-gear. Discussing the visible mechanism first, it may be mentioned that a spring film-trap serves to hold the film against the aperture in the main plate, and can be turned in or out of action by a vertical rod. In this machine there is no upper sprocket-roller, but its place is taken by a curved incline pivoted to the arm which carries the feed-spool. This guide is maintained normally in position by a spring, thus keeping the film taut; but when the bottom sprocket-roller draws more film the spring guide tilts downward, thus supplying the required length of film. The spring then returns the guide to its normal position, and draws more film from the feed-spool in the process. The take-up spool is driven by



a friction band from the axle which both works the shutter and conveys power to the interior of the casing before referred to, of which Fig. 131 will help to reveal the hidden mysteries. A cheaper dog-motion machine is also issued by the same maker.

#### ANGLO-CONTINENTAL COMPANY'S "KINEMATOGRAPH."

This apparatus was used at the Aquarium for the exhibition of the celebrated prize-fight, the negatives of which were secured by the "Veriscope." The instrument was electrically driven, intermittent motion being obtained by means of a variable-screw acting on a cogged wheel attached to the sprocket-roller.

#### BING'S TOY KINEMATOGRAPH.

The toy lantern made by Messrs. Bing, and shown in Fig. 183, employs specially prepared films with printed pictures standing side by side, the band being driven by a Maltese-cross movement, and periodically occluded by a segmental shutter. The action is very effective, and evidently apparatus of this character may well be entrusted to children who would never be allowed to handle photographic films of a comparatively costly nature.

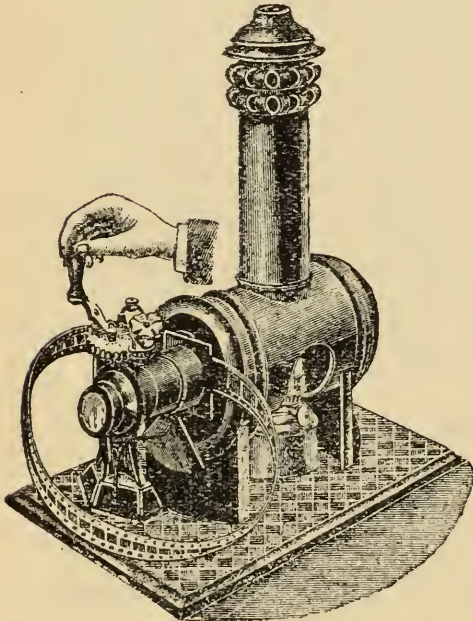

FIG. 183.



## MESSENGER'S "PANTOMIMOGRAPHE."

This is described as a Maltese-cross motion machine. It is constructed by Alibert, and was exhibited at Earl's Court.

## MAZO'S HELIOGRAPHE.

A compact machine with cross-actuated intermittent motion, capable of serving both for photography and projection.

## THE "INVICTA" CINEMATOGRAPH.

Messrs. Noakes and Norman's machine is shown in Fig. 184. The film is actuated by a pin- or claw-motion, and in adjustment only requires to be fed into the machine, when it is automatically seized. There is no sprocket-wheel for driving the film. A new machine on a different principle is in preparation, but is not sufficiently advanced for publication of the details.

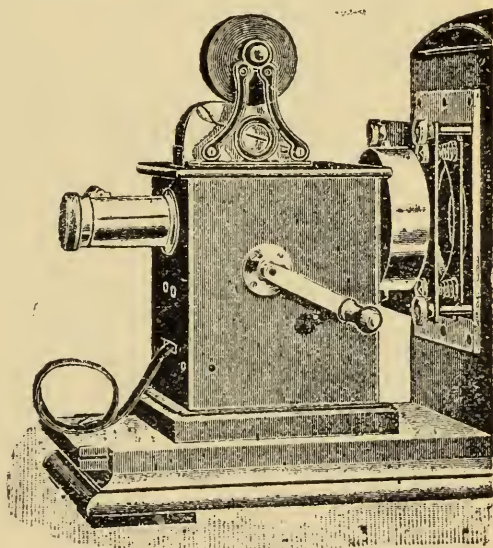

FIG. 184.

## THE "PRESTWICH" MACHINES.

Of many patterns placed on the market by the Prestwich Manufacturing Company, space permits the description of but a few. Fig. 185 shows Model 3 Projector, the film being intermittently actuated by a dog-motion. This machine is fitted with automatic feed and take-up attachments, the spools being capable of accommodating up to 2,000 feet of film. Two simpler

patterns are constructed, but all have a removable shutter and interchangeable sprockets, which may be rapidly adjusted in order to pass a film of any gauge through the machine without possibility of damage. As many films of apparent Edison perforation are found, when tested, to be out by anything between

$\frac{1}{64}$  to  $\frac{1}{16}$  inch in the space of four pictures, this detail is of considerable importance. The simpler forms of camera are provided with focal-plane shutters, inter-

mittent motion being secured by an epicyclic sprocket, such as was shown

in Fig. 127. All the instruments referred to may be had to

work with films  $1\frac{3}{8}$  or  $2\frac{3}{8}$  inches wide. For the larger pic-

ture a duplicate projector is constructed, the film being actuated by a pair of

epicyclic sprockets, the two sprocket - motions, together

with the shutters, being so geared that there is no period of darkness on the screen whatever, and consequently flicker is entirely

absent. The latest form of camera, which may also serve as

a printer, is shown in Fig. 186. This machine is provided with a large view-finder and a recording-dial, which shows exactly how much film has been used; the importance of this attachment cannot be over-

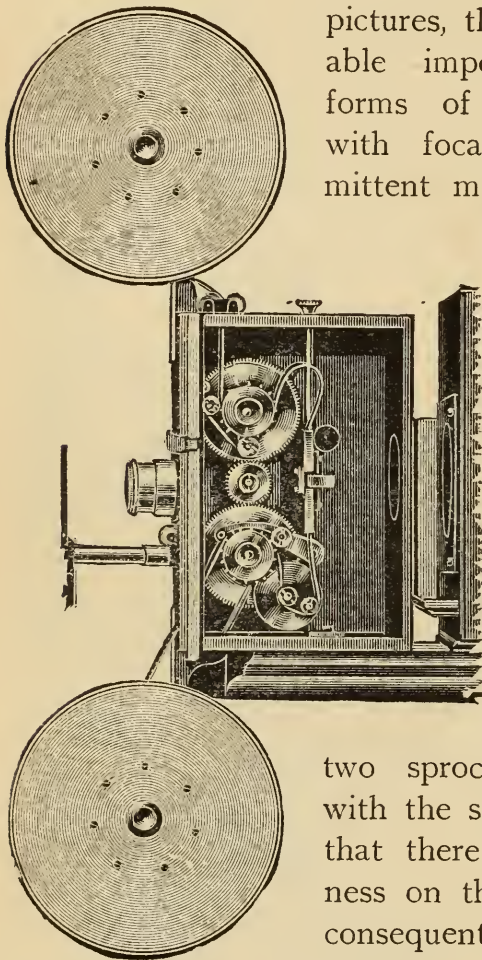

FIG. 185.

estimated when long scenes are being photographed, or

when several short episodes are taken on one long film, for it gives an absolute indication of how much film remains unused. The intermittent motion is a greatly improved guided claw, perfectly effective however high the rate of working, and it will be seen that feed and take-up are exactly balanced by driving the film from two sides of the same sprocket.

But the production of this long series of machines has not exhausted the resources of the Messrs. Prestwich; on the contrary, they have been stimulated to fresh efforts, which undoubtedly will

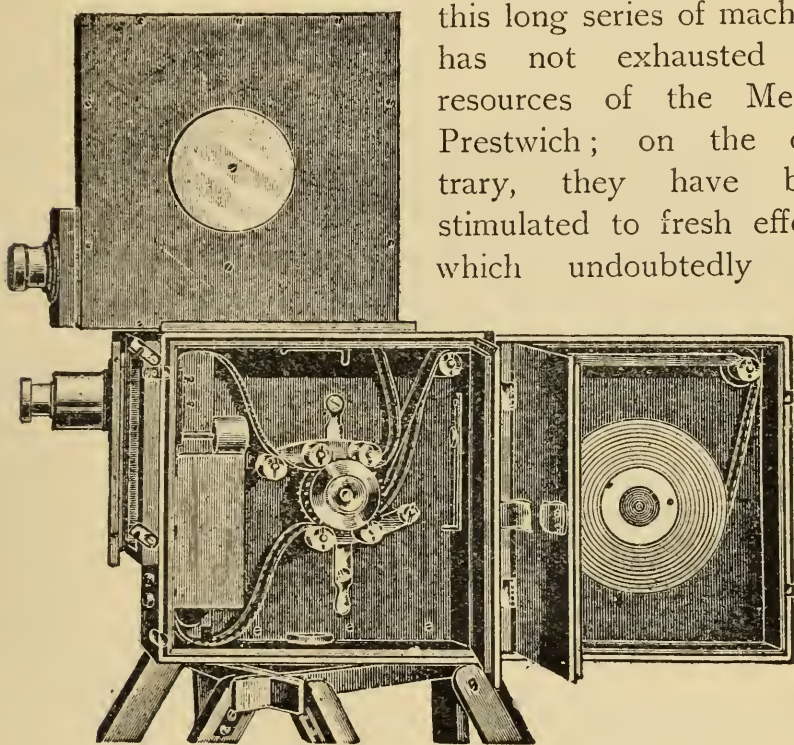

FIG. 186.

have a considerable influence on the future of Animatography. At the time of writing a new machine is in course of manufacture in bulk, and doubtless before these pages are read the machine itself will be on the market. It is to be called the "Junior" Prestwich, and, like the juniors of most families, will make a noise in the world. To descend from the region of metaphor



to that of facts, this "Junior" is a small camera which may also serve as projector. Fig. 187 shows the apparatus, the dimensions of which are far more restrained than those of the usual quarter-plate hand camera. Nevertheless, this machine will take a view of a scene equal in duration to those commonly exhibited, and in use it is simplicity itself. The daylight spool of film,  $\frac{1}{2}$  inch wide, is laid in a recess, the end fed forward, and one turn given to the handle. The film is automatically gripped and placed in correct register,

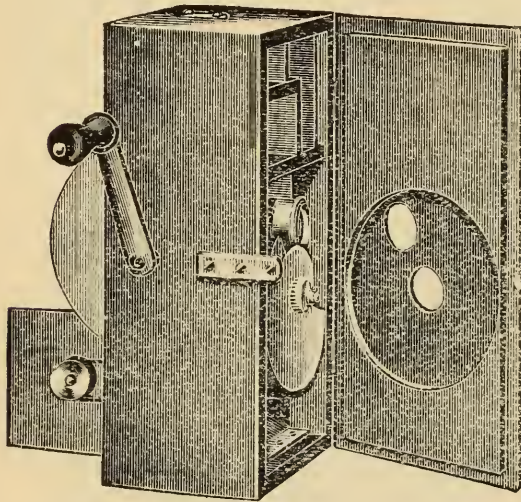

FIG. 187.

and thenceforth, however fast the machine be driven, its action is regular and safe. The shutter is detachable for projection purposes, and a rewinding device is supplied for connection to the apparatus. The pictures obtained are  $\frac{1}{2}$  inch by  $\frac{3}{8}$  inch, and certainly

leave nothing to desire on the score of detail. In fact, the apparatus is as effective in every way as a larger machine, with the important difference that the cost of working is reduced to one-sixth by reason of the smaller area of the film consumed. Such a reduction at once brings the Living Picture into the hands of many who have no idea of exhibiting, but who will welcome a new and fascinating hobby, provided that the expense of its pursuit be not excessive.

Further, a new form of duplicate projector is in



preparation, but not sufficiently near issue to allow of detailed description, although the Author was enabled to inspect one in the Company's works; for admission to which, as well as for information on many points of general interest, the Author is greatly indebted to Messrs. Prestwich.

### THE ALETHORAMA.

This instrument, a recent invention of MM. Mortier and Chéri-Rousseau, is shown in diagram in Figs. 188 and 189. It will be seen that the principles involved are those of the Praxinoscope. The film *F*, Fig. 188, passes round a drum having a continual rotary motion, each picture being centred opposite a mirror behind the film similar to those seen on the left hand. Referring to Fig. 189, it will be seen that light from the condenser *C* passes through the film on to one set of mirrors, from that to another set standing at  $90^\circ$ , and thence through an objective the

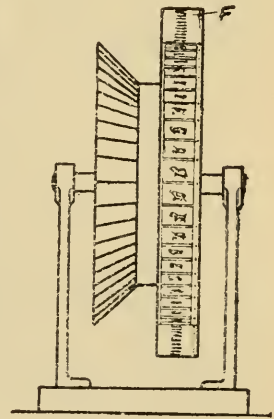

FIG. 188.

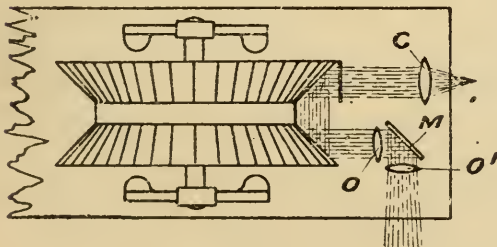

FIG. 189.

two elements of which, *O* and *O'*, are placed at right-angles, the light being turned by a mirror, *M*. The film, as in the projecting Praxinoscope, is in continual movement; the image is rendered stationary by the polygonal mirrors as explained on page 27. This apparatus is capable

of working at high speed, there being no intermittent mechanism and no interval of darkness between successive pictures on the screen. The suggestion made on page 31 therefore seems within a measurable distance of realisation.

### THE RILEY "KINEOPTOSCOPE."

This machine is made in several patterns, though the working arrangements are similar in essentials. Fig. 190 shows the apparatus as constructed for insertion in the stage of an ordinary lantern for home use; while by another arrangement the apparatus slides on a front baseboard

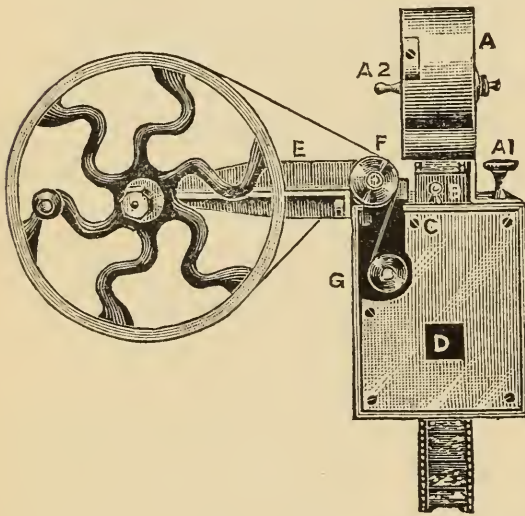

FIG. 190c.

so that the picture may be shifted into better position along the conical beam of light from the condenser. The motion employed is a four-toothed claw inserted to draw the film down and withdrawn previous to rising. The arrangement is such

that an amount of play equal to half the width of a perforation is afforded in order to avoid "punching" an inaccurately gauged film. The apparatus may also be fitted as a camera. This machine has been shown under the name "Steenomatographe," an evident derivation from the exhibitor's surname.

## NEWTON'S "ENGLISH" KINEMATOGRAPH.

This apparatus (Fig. 191) differs from the usual type in several important particulars. It may be adjusted before the condenser of any lantern body, but is itself furnished with a supplementary condenser, which serves for the final concentration of the light upon the film. The intermittent motion is obtained by a revolving eccentric, which is always kept in contact with the film, thus avoiding sudden shock. This eccentric is mounted on a swinging arm, and may be shifted when placing a fresh film, in order to bring the view into register by slightly lengthening or shortening the path of the film. The whole apparatus may be inverted for the exhibition of reverse effects, thus obviating both rewinding and the use of a prism. Chain-gearing is used for driving. An inspection apparatus on

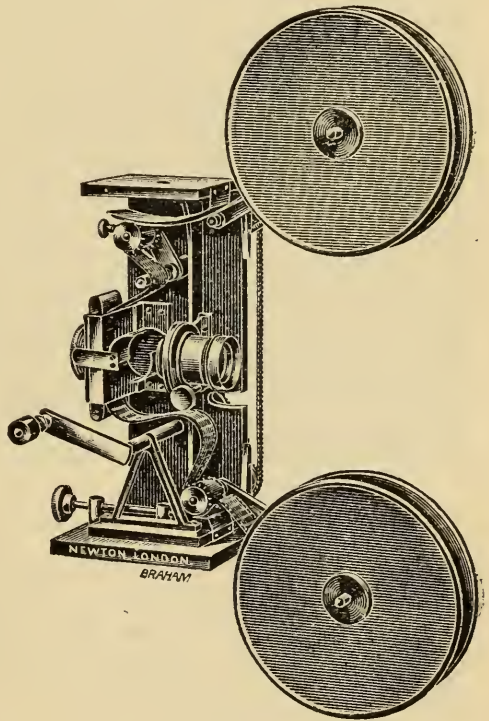

FIG. 191.

somewhat the same lines is made by the same firm, and called the "Newtonian Table Kinematoscope," the film being run under a magnifying eyepiece, and tinters being provided for effect purposes. A further attachment allows the picture to be projected on a 5 by 4 ground-glass screen by an ordinary table-lamp.







## OTTWAY'S "ANIMATOSCOPE."

This machine, which is of very solid construction, employs a Maltese cross actuated by two pins on a smooth disc as the intermittent mechanism. The shutter is serrated at its edges, and thus passes a shadow with an ill-defined edge across the screen, as in the older forms of dissolving view apparatus. When it is desired to project ordinary views during film-changing, a mirror is turned up at an angle of  $45^{\circ}$  before the condenser. The light then, instead of passing through the front mechanism, is deflected upward through a horizontally placed stage carrying an ordinary slide. The light then passes through an ordinary projection lens placed above the stage, and so, by a deflecting mirror, to the screen.

## THE CYNNAGRAPH.

This apparatus, shown in Fig. 193, is of the pin-and-star variety, and, though small, contains all the adjustments usual in larger machines. It is constructed by Messrs. J. Levi and Co., who also make a larger machine called the "Rollograph." A small lantern, the "Amateur Kinematodor," is also issued by the same firm, the views being borne on a disc instead of a strip, and being prepared in colours by lithography.

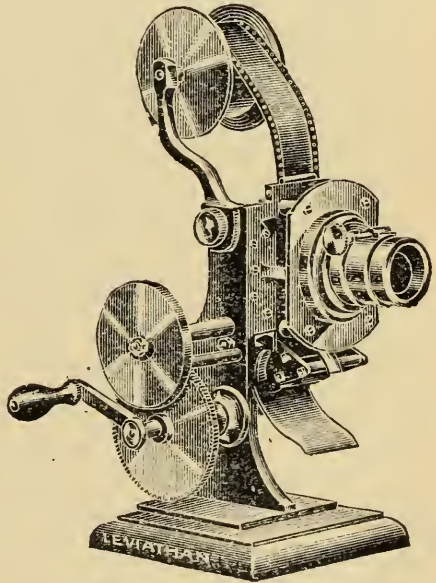

FIG. 193.

## THE "BESSUS" CINEMATOGRAPH.

This machine (Fig. 194), formerly known as the "Airs," moves the film by a Maltese-cross motion. Film-

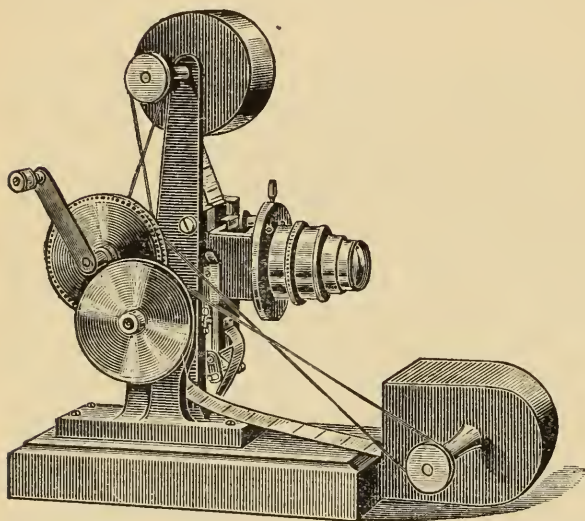

FIG. 194.

winder and intermittent mechanism are band-driven from the driving-wheel in such a manner that the film may be moved and automatically paid-out and wound-up in either direction. The lenses are fitted in interchangeable

cylinders fitting one jacket, thus affording a choice of foci.

## PAUL'S "FIREPROOF" ANIMATOGRAPHE.

This apparatus, first named the "Theatrograph," is best known through the pictures shown by its agency night after night for more than a year at the Alhambra. The intermittent mechanism is somewhat like that shown in Fig. 120. In order to facilitate placing the film, the sides of the sprockets are left open, and the whole apparatus is extremely compact. A shutter may be rapidly adjusted when deemed necessary, and the machine is designed to carry extra-large spools. As regards safety, the very name of the apparatus indicates the special care devoted to the avoidance of accident from ignited film.

## WOLFF'S VITAPHOTOSCOPE.

This machine is, above all, characterised in its new form by extreme stability, combined with portability. The lantern and projecting-apparatus are firmly fixed to a base-board which, together with all the other parts, packs into the case to which the driving-wheel is seen connected in Fig. 195. When required for use, the lantern and projector are lifted out and attached by the base-board to the top of the case by means of

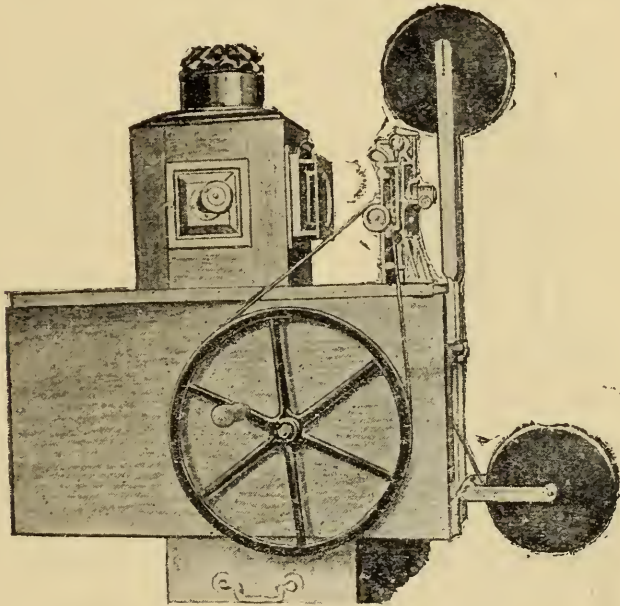

FIG. 195.

two screws working from inside. The driving-wheel and spools, with their standards, are then mounted in their proper brackets, and the apparatus is ready for use. The driving-wheel is heavy enough and geared sufficiently high to serve as a fly-wheel, the band from which drives a pin-disc, which actuates a Maltese-cross somewhat in the same manner as shown in Fig. 118. The spools are of large dimensions, and the film passes from the top one to a feeding-sprocket, which forms



a loop above the "gate." After it has been pulled down by the lower sprocket, the film passes over a guard and through an aperture into the interior of the case, where it may accumulate, or be drawn-off, as shown in the illustration, on to the lower spool, which is hand-driven.

WRAY'S MACHINES.

The ordinary machine, as seen in Fig. 195A, is characterised by extreme portability, as well as the manner in which it may be adapted to any ordinary lantern.

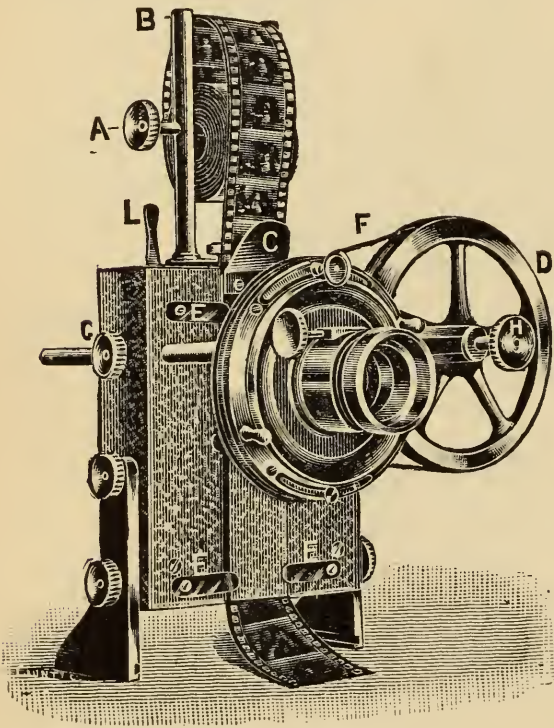

FIG. 195A.

The band passing from the driving wheel rotates a crank disc, the pin on which raises and lowers a plate having two projecting studs which run through slots and come in contact with the film. Through these studs two small pins are protruded under spring-pressure in order to enter the film perforations, and they are both

allowed to go forward and are forced back by the action of a cam disc reciprocated by a lever connected to the same crank pin which raises and lowers the whole frame. The whole mechanism is therefore extremely compact, for it practically consists of but two



plates, one behind the other. The film-trap is slotted to allow play to the teeth, and is lightly held in position by spring pressure. The mask is lever-actuated. A machine for films of much greater dimensions is in preparation, and will probably overtop the Mutograph record, a specimen picture appearing to approach the standard of ordinary lantern slides.

#### NEWMAN AND GUARDIA'S "KINETOGRAPH."

At the moment of closing this chapter an opportunity occurred of inspecting a machine which is probably the very latest, it having hardly made its appearance before the public. The features of this instrument are so striking as to merit somewhat full description. It need hardly be said that the great desideratum in kinematographic machines is increase of light efficiency, and this end is almost perfectly attained in Newman and Guardia's Kinematograph, about 90 to 95 per cent. of the total time of one cycle of movement being devoted to exposure. Thus in securing the normal number of views per second the light efficiency compares favourably with most hand-camera work, and a far greater power of stopping-down is placed in the hands of the photographer. At ordinary apertures work may be pursued in light hitherto unsuitable, while with normal conditions of light and atmosphere the lens may be stopped so as to give detail to an extraordinary degree. How this end is secured may be simply explained, but it is best to first obtain a general idea of the machine. Fig. 196 shows the projector from the front. The film-spool is dropped into a self-adjusting slide at the top, and the end of the film is led between rollers, which drive it by friction on the margin only. These rollers themselves are frictionally driven, and therefore plucking of the film is impossible. A slight turn of the handle drives the film under the

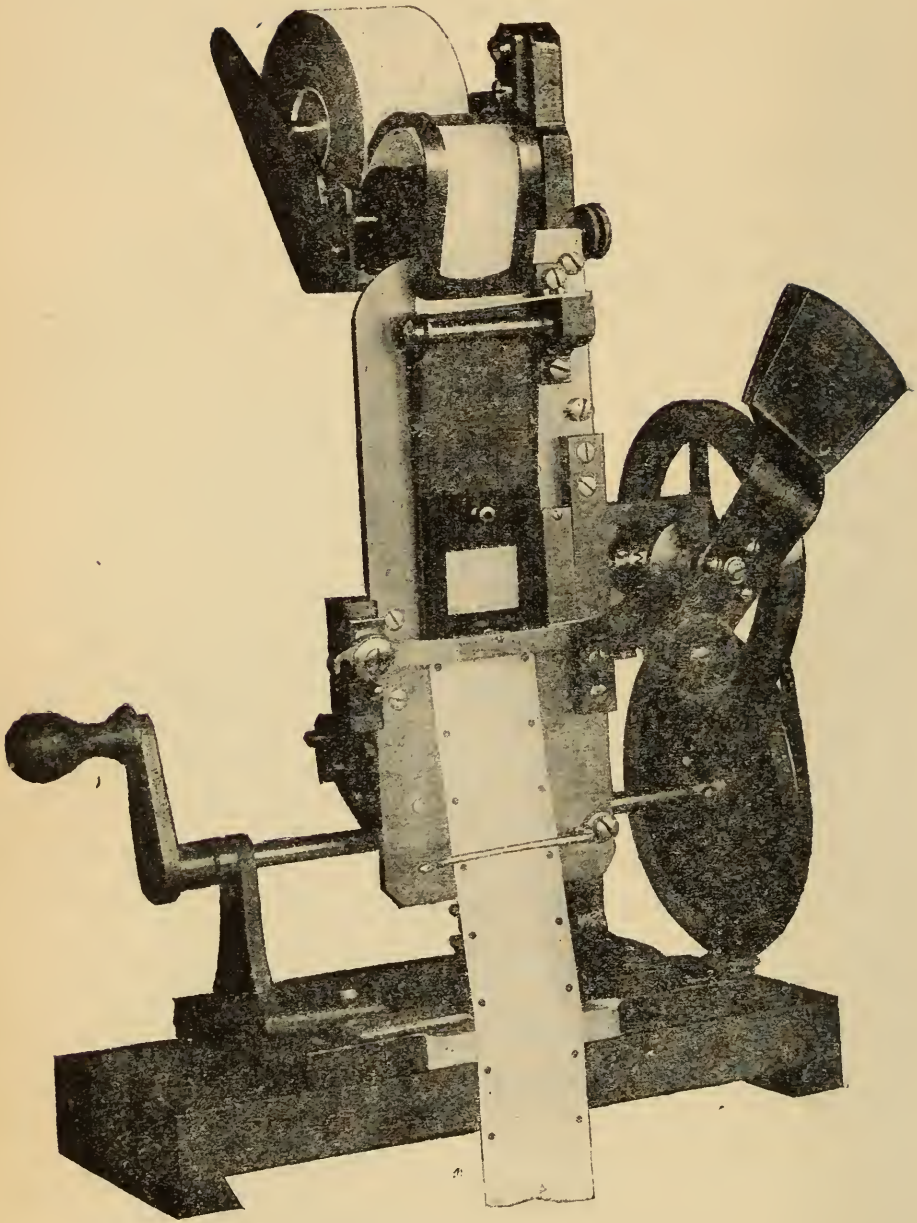

FIG. 196.

curved guard, the film-trap is thrown up on its hinge, under which the film is inserted from the side, and then hangs free over a perfectly clear metal plate. Through two slots in this plate two pins protrude, the film is adjusted so that these pins engage with a pair of perforations, the film-trap is let down and the clamping-bar locked over it, and the machine is then ready for work. The fly-wheel seen on the right acts as a speed-regulator, while it will be noticed that the balanced shutter in front is of extremely small angular dimensions. It occupies barely one-twentieth of its circular path, which is equivalent to saying that over nineteen-twentieths of the light passes to the screen, a practically unsurpassable degree of efficiency. Also the period of rest is nineteen times as long as the period of movement; reference to a small diagram will render clear how this state of affairs is brought about. Fig. 197 illustrates

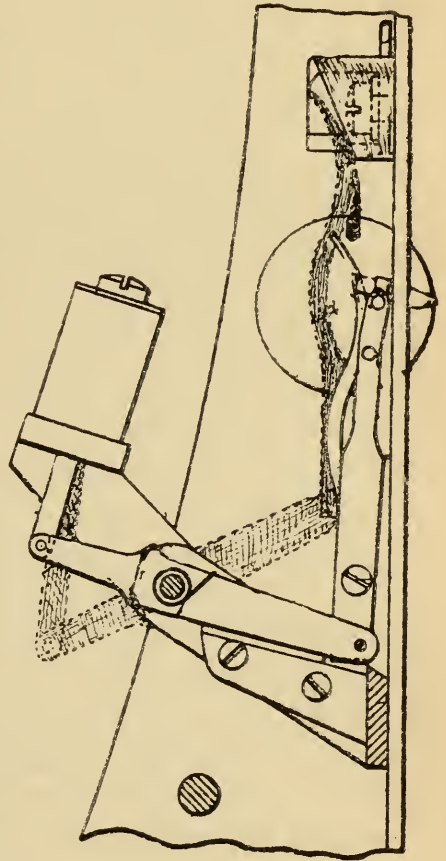

FIG. 197.

the method by which the pins are actuated; they are shown passing through the slotted plate and film perforations, having just arrived at the end of their stroke. They have been drawn into this position by two springs, one pulling downward, the other drawing the teeth forward. Arrived at the bottom of the slot, and

having thereby placed a picture in exact position, the cross-bar seen in the front of the illustration of the complete machine is tightened by a cam, and thus grips the film securely between the film-trap and the main-plate. This done, a little peg on the rotating disc, seen in the centre of the diagram, comes round from right to left at the bottom, catches under a shoulder on the lever bearing the pins, and forces them backwards out of the perforations. Continuing its motion, this peg carries the pins backwards and upwards against the action of the springs. Arrived at the top of its path, the motion of the pins becomes forward, and the lever then stands in the position shaded on the diagram, the pins being omitted for the sake of clearness. The peg continues on its way, but the lever cannot follow it because it butts against a cam-surface as seen in the drawing. The peg therefore passes from under the shoulder on the lever, and continues its journey back to the position in which we first found it. At this moment the springs become free to act, and the levers are drawn down as "quick as thought." The clamping-bar in front has been released just previously, and the upper feed-rollers have been paying out another picture-length; consequently the pins have no weight thrown upon them, and act rather as guides. An adjustable "dash-pot" buffers the end of the stroke, and the whole is now in the position from which we started. The pins are primarily arranged to engage with holes situated at the centre of each side of the picture, their ends being tapered so that they will enter a hole which is slightly out of gauge and bring it into exact position by passing right into it. On turning the snail-shaped releasing cam, the lever may be freed somewhat sooner, and the points being tapered chisel-fashion, they will therefore enter Edison or other perforations equally well. The whole apparatus is fitted on a base-board



which slides on guides in front of an N. and G. Lantern, other projection fittings sliding to the same gauge; in fact, a sideways sliding-base enables Kinematograph, ordinary projection front or lantern-microscope to be alternately centred to the condenser at a moment's notice. So much for the Kinematograph. The Camera is the same in principle, but varies in detail. The daylight film-spool is placed in a drawer at the inside top of the case at the back. The film passes from this drawer over exactly the same path as in the projector, except that the continuous upper feed is given by a sprocket-wheel which is exceptionally well arranged for placing the film. The fly-wheel stands across the front of the machine, being combined with the shutter, and is made heavier in order to serve as a speed regulator. In fact, in driving this machine the hand, so to speak, follows the fly-wheel, and is far less prone to fall into a jerky motion. On leaving the exposure-aperture the film is, of course, wound on a spool which can slip on its axle in order to adjust its speed in case of any temporary check. The strain in this case usually falls on the film, but in this camera any tightening of the film raises a very light lever, which immediately locks a ratchet on the edge of the spool-carrier. The strain is thus promptly taken off the film, but so soon as the tension ceases the lever drops, releases the spool-carrier, and things pursue their normal course. The whole apparatus is contained in a morocco-covered case no larger than a twin-lens quarter-plate camera, notwithstanding the fact that a side cupboard is provided to carry six spare spools and accessories. Not only is a finder fitted, but a safety aperture permits the inspection of a magnified image on the film itself during working, while a register is provided showing the amount of film consumed, and is capable of being reset to zero in the event of two scenes being taken

on one film. These machines were kindly placed by Mr. Guardia at the fullest disposal of the Author, in spite of the fact that preparation for the market was in full swing, and acknowledgment is certainly due to Mr. Guardia for the courtesy which enabled the inclusion of this description.

#### MISCELLANEOUS MACHINES.

The descriptions which have been given probably cover all typical apparatus, and also the bulk of the curiosities connected with Living Pictures. Yet there are other machines; and it may be well to mention them in order that their existence may be placed on record. The Berthon - Bressard - Jaubert Cinémicrophonographe is, for the present, a name and nothing more. The apparatus is intended to reproduce events and their accompanying sounds on a large scale at the coming Paris Exhibition of 1900. J. B. Colt and Co.'s Criterioscope is a dog-motion machine; and the De Bedt's Kinetograph works on principles explained in connection with Fig. 116. The Dom-Martin Cinéma is said to possess a spring-escapement mechanism; and the so-called "Edison" Vitascope was of an ordinary dog-motion type, power being transmitted from the main-shaft by bevel gearing. Hanau's Cinématographe Universel is a combined camera and projector, a simpler form known as the Hanau-Gauthier Chronoscope being fitted for home projection by oil or acetylene. The Biographe "Lear," otherwise the Biographe français, is also intended for home use, and gives a three-foot picture while employing ordinary films. Other toy lanterns using strip films are made by Carette and Co., a similar pattern being on the French market as the "Eureka." One German toy lantern has a disc made of cardboard, the separate chromo-litho pictures being mounted in specially formed apertures. Baxter's

"Perfection" Cinematograph is a compact apparatus somewhat like Fig. 135 so far as the intermittent motion is concerned. Appleton's Cieroscope is a combined camera and projector. The Vieograph was shown at Earl's Court Exhibition, 1898. A miniature "Biokam" is in preparation by the Warwick Trading Co.

Other machines are Beard's Cinematograph, Clément and Gilmer's Vitagraph and Mutograph, Haydon and Urry's Eragraph, Harvard's Cinematoscope, Neumann's Cinematograph, Pirou's Cinématographe, Sears, Roebuck, and Co.'s Optigraph, Stock's Biographe "Soleil," Griffin's Cinematograph, Vever's Viviograph, the Velograph constructed by the Velograph Syndicate, Wood's Movendoscope, Levi Jones and Co.'s Matagraph, Foersterling's Scenetograph, Rowe's Pictorialograph, the Cinematograph Co.'s Projector, and a machine made by the Anglo-American Import Co.

After perusal of the foregoing pages it may be thought that names, no less than mechanical principles, have been wellnigh exhausted. But, unfortunately, some enemy of mankind once compiled a list of names applied to Living Picture machines. He evidently consumed the midnight oil, probably exercised a certain amount of invention; and his list, passed backwards and forwards through several languages, now affords a terrible example of the results of misapplied ingenuity. Many of the names are genuine and have been accounted for; some have nothing to do with Living Picture machines; the remainder, if authentic, belong to apparatus which hide their light under an extremely opaque bushel. For instance, as regards misapplied terms, the Vistascope is Eddy's apparatus for obtaining a bird's-eye landscape by means of mirrors suspended from a kite; the Aërial Graphoscope is a revolving lath used by Bruce as a lantern screen for obtaining ghostly images, and not necessarily applied to Living

Pictures at all, while the Kinegraph is merely Engelmeier's mechanical device for automatically describing resultant forces. Again, Liesgang's Velotrope turns out to be a pneumatic slide-changer, a very effective instrument for its purpose, but not in any way connected with the subject under discussion; while the Phantascopie is Locke's instrument for giving single vision with two eyes, and the Vélodigraphe and Foliographe are merely French hand-cameras. The Troposcope is an apparatus made by Casselli for inverting or erecting telescopic images; and other instances might be quoted to show how unsafe it is to assume the character of an apparatus from its name. While dealing with the subject of nomenclature, it is interesting to note that the first use of the term Cinématographe was of earlier date than the machine to which it is now applied. On the 12th February, 1892, Bouly took a French patent "pour un appareil photographique instantané pour l'obtention automatique et sans interruption d'une série de clichés analytique du mouvement ou autres, dit le Cinématographe." This specification is not printed by the French Government; in fact, many inventions of considerable interest are similarly denied publicity. Variety in names does not obtain among machines merely; Kinetoscopy, Cinematography, and other terms have been suggested as suitably defining the whole art, though none has been universally adopted. A very early suggestion of the words Photographic Effects was made by Mr. Hay Taylor so long ago as 1889 in connection with Greene and Evans' machine, but probably the term Animatography will in the end be found most generally acceptable. In fact, all through the subject there is some confusion of terms, and if we trace the expression Living Pictures back to Tableaux Vivants, it is at once brought to mind that Mr. McDougall and the London County Council—but that is another story!



And now, merely for the sake of completeness, a list is appended of every remaining alleged name which has been noted in a somewhat extensive research; some appear to be derived from personal names, others to be mere mis-spellings, but the list will serve as a warning against the production of further etymological monstrosities.

Anarithmoscope, Artograph, Badizograph, Centograph, Chronophotographoscope, Cinagraphoscope, Cino-graph, Cinomograph, Cinoscope, Cosmonograph, Cosmoscope, Diaramiscope, Electroscope, Hypnoscope, Kathoscope, Katopticum, Kinebleposcope, Kinematoterm, Kinesetograph, Kinesterograph, Kinetinephone, Kinevitagraph, Luminograph, Magniscope, Mouvementoscope, Motorscope, Mutuscope, Panoramograph, Pantamimio-graph, Pantobiograph, Phantograph, Phonomendoscope, Photomotoscope, Photokinematograph, Phototrope, Rayoscope, Scenamotograph, Stereopticon, Stinetiscope, Taumatograph, Thromotrope, Variscope, Venetrope, Viroscope, Virtescope, Visionoscope, Vitaletiscope, Vitamotograph, Vivendograph, Vitopticon, Vivrescope, Watëroscope, Wonderscope, X-ograph, Zeoptrotrope, Zinematograph.

After mature reflection, as regards the majority of the above alleged machines, there is but one quotation which meets the case. In the words of the immortal Betsy Prig, "wich I don't believe there ain't no sich party!"

## CHAPTER V.

### FILMS: THEIR PRODUCTION AND TREATMENT.

A FILM for projecting a Living Picture is nothing more, after all, than a multiple lantern slide; and its production is therefore in all respects similar, with the exception of those manipulative details necessitated by its peculiar form and the special care required to secure absolute registration of each picture with its predecessor. In order to describe all such devices connected with the treatment of films, it may be assumed that whatever is good enough for a lantern slide is the correct thing in treatment for a kineto-film, only probably not good enough. For all practical purposes the subject may be considered as limited to the consideration of celluloid films, for up to the present that substance is the only one that properly fulfils a majority of requirements.

Celluloid as an article of manufacture was invented by the Brothers Hyatt in 1869, but at that time it was designed merely for the production of solid objects. It was not until about the beginning of 1888 that sheets were available for photographic purposes, and even then much remained to be accomplished in order that a sensitive emulsion might be supported evenly and without deterioration. The Blair Company seem to have first supplied films, and it was from them that both Edison and Acres in the first instance obtained their supplies. The Eastman Company quickly followed suit, and Messrs. Lumière, being manufacturers, made their own from the first—a fact which is probably the origin of present lamentable want of uniformity in

gauge. Strangely enough, after the lapse of nearly twelve years, during which rollable films of various makes have been on the market, an American patent was granted to the Rev. Hannibal Goodwin on September 13th, 1898 (No. 610,861), the documents of which had lain under dispute since the date of their filing on May 2nd, 1887. It may be that this patent will not have so much effect as the inventor assumes, and some American journals claim; but in any case it is strange that a small subject such as Kinetoscopy should afford two instances of patents so long delayed. If this patent and the one on the Kinetoscope accomplish all that their inventors anticipate, the American trade in perforated films will be somewhat heavily handicapped; fortunately the matter concerns the United States alone.

But to return to the manufacture of films. Broadly speaking, a solution of nitro-cellulose in nitro-benzole or its equivalent is mixed with camphor, etc., and allowed to harden into sheets by the evaporation of the solvent, and is then coated with a sensitive emulsion. For ordinary purposes this sheet or long roll is merely cut into the requisite sizes; for kineto-films it is passed through roller-shears, which divide it into ribbons. As before mentioned, the Mutograph films are  $2\frac{3}{4}$  inches wide, and this gauge stands alone. The large Demeny Chronophotographe and Skladowsky's Camera take films of 60 and 65 mm. respectively, while the Lumière and Edison gauges are almost identical, the former being 35 mm., the latter 34.8 mm., equal to  $1\frac{3}{8}$  inches. A Prestwich Camera for  $2\frac{3}{8}$  films is also made, corresponding almost exactly in dimensions with the Demeny 60 millimètres. The respective sizes of these films, together with their proper perforations, are shown in Fig. 198. Since this was drawn, "Birtac" films of half the width of Edison standard, and "Junior" Prest-

wich, on a similarly small scale, have been introduced. It will be seen that the same regrettable want of uniformity exists both in the perforations and the films themselves, the Lumière picture being furnished with two holes, the Edison with eight for a view of approximately the same dimensions, and the Demeny with eight for a larger picture. Correctly perforated Edison

film should have the holes exactly  $\frac{3}{16}$  inches apart lengthwise, the crossway separation being  $1\frac{1}{64}$  inches. The perforations

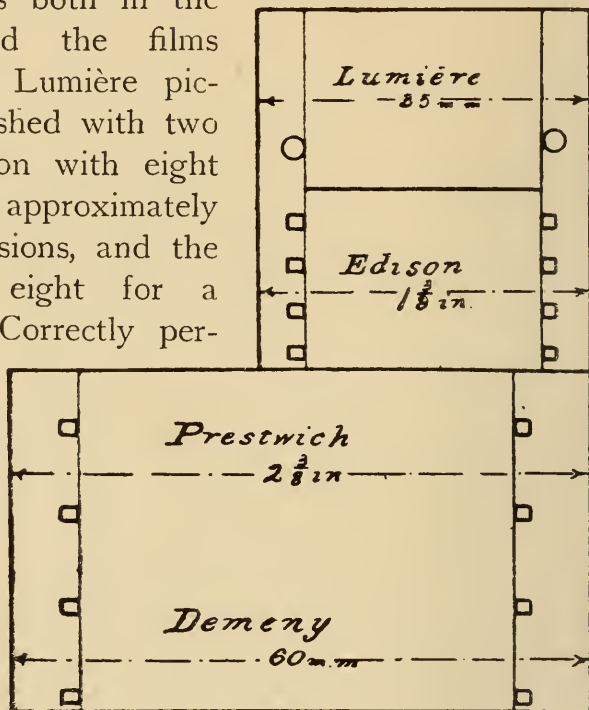

FIG. 198.

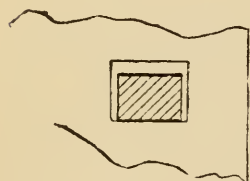

FIG. 199.

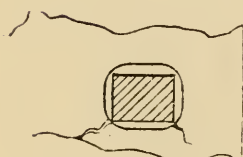

FIG. 200.

of about  $\frac{1}{16}$  inch, but their shape is by no means constant. The Lumière holes are round; other makes vary from true right-angles to a most pronounced cushion. Sprockets are often square, or at least right-angled, and Mr. Jenkins is a strong advocate of right-angled perforations for that reason. By a comparison of Figs. 199 and 200 it will be seen that the sprocket lies true against the edge of a right-angled perforation, but bears on a cushion-shaped one by its corners only. In this latter



case rupture of the film is manifestly far more probable. The importance of these considerations is heightened when the question of strain on the film is considered. Tension on the film is shared between the perforations actually engaged with the sprocket-teeth, and it would appear easy to carry the film round the major portion of the sprocket-roller, Fig. 201, in order to subdivide the strain as far as possible. But this can only be done to a limited extent,

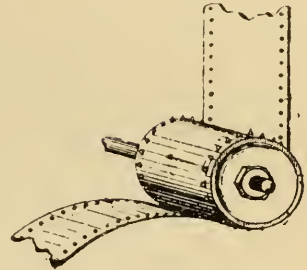

FIG. 201.

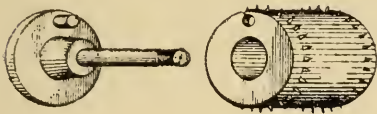

FIG. 202.

for not only do various films differ slightly in gauge, but shrinkage in development and even atmospheric influences tend to vary the distance between the perforations.

In fact, in most sprocket machines the film must lie somewhat more loosely in one case than another, according to the greater degree of separation of the perforations, while interchangeable sprocket-rollers, Fig. 202, are sometimes provided to suit the special make of film under exhibition. It would seem that shrinkage had much to do with slight differences in perforation gauges,

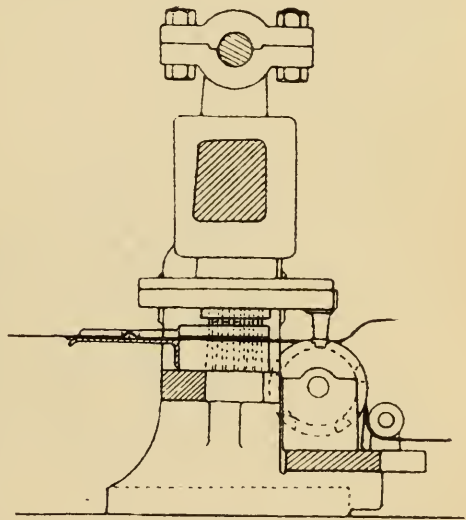

FIG. 203.

for at first perforating machines were in some instances made to agree with finished films rather than with the

original perforating machine, as should have been the case.

How the perforations are made will be seen in Fig. 203. This machine is the perforating apparatus devised by M. Lapipe. The film enters from the left-hand, and is steadied by small rollers, being drawn along by a sprocket-wheel on the right, which engages with the newly made perforations. A plunger is furnished with rods, which are driven down into holes in a lower plate, perforating the film in their travel. Above the film is a movable plate, which carries a tooth so arranged as to drop into holes in the edge of the sprocket-wheel and lock it. The whole action is as follows.



FIG. 204.

When the pins are raised, so also is the tooth, and the sprocket-wheel is free to draw a fresh piece of film into position. The plate then drops; the tooth locks the wheel, thus stopping the motion of the film, which is steadied by the downward pressure of the plate. The

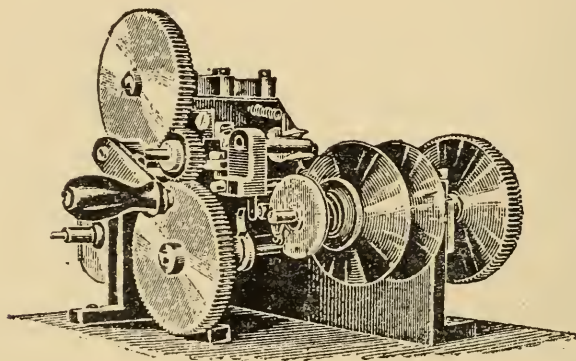

FIG. 205.

rods then descend, perforating the film. When they return, the cycle of operations is repeated. The tooth only serves to *steady* the sprocket-roller, which is

intermittently actuated by means of a ratchet-gear, shown in Fig. 204. Messrs. Clément and Gilmer build a machine on somewhat similar lines, and Mr. Jenkins has a rotary perforator, electrically driven, capable of making 15,000 perforations per hour. Fig. 205 shows a hand-driven perforator constructed by Messter, but a larger pattern with electric motor attached is also made. It must not be forgotten that in some types of projectors (for example, certain continuous-motion apparatus, and others in which the film is gripped, not held by teeth) perforations are not necessary, although they are not detrimental if present; while various extraordinary suggestions have been made, such as central eyelets, which would hardly facilitate rolling, and the carrying of perforations across the film between each picture—presumably in order that they might be torn off like postage stamps. Reference may also be made to Fig. 95, wherein a film is shown notched on the edges; the advantages of this system certainly are not obvious.

So far as the actual use of a film in the camera is concerned, the previous chapter has recorded all the present methods of passing it before the lens for exposure purposes, but in matters of practice a few remarks may not be amiss. In the first place, absolute rigidity of the camera is a *sine quâ non*. The enormous magnification to which a film is subjected in the process of projection renders it absolutely essential that vibration be eliminated entirely, and with this object the stand employed should receive rigorous criticism. In some cases, of course, portability must be considered; and with an apparatus of light build any ordinary tripod

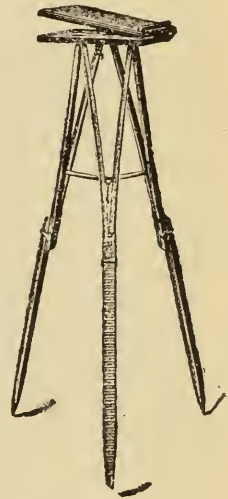

FIG. 206.

of good character may be employed, as for instance Brown's, Fig. 206. An advance on this is made by Messrs. Gaumont, who have introduced a stand with solid top, bearing metal sockets into which three metal tubular legs screw. When fastened together, this stand is practically one piece, and hinged joints being absent, vibration is reduced to a minimum. For photographing set pictures—that is to say, the reproducing of acted episodes—any solid form of studio stand will meet all requirements; but special cases need special devices, and it will be remembered that the "Mutograph," with

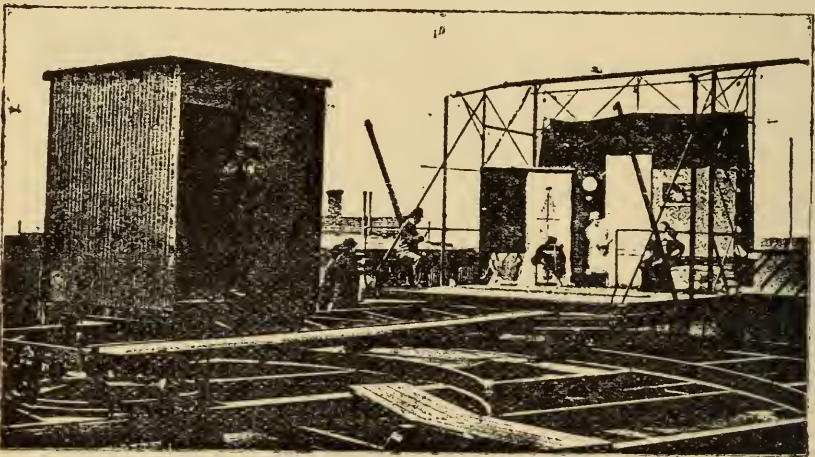

FIG. 207.

its larger views, requires a support which can only be regarded as almost a basement, speaking in an architectural sense. As an example of the elaborate devices necessary in commercial work, the open-air studio of the Mutograph Company may be referred to. It is, of course, necessary to have sunlight for all pictures, even when they represent interiors, and the manner in which this is secured will be seen in Fig. 207, a view on the roof of the Company's New York premises.

It is not only the stand which needs attention. We



all know how *fortunate* some photographers are in hand-camera work, but, after all, this is only an equivalent expression for *competent*. It is certain that a good operator is necessary in the successful management of any kinetographic machine; for not only must focussing and selection of time and subject be more carefully considered than in all ordinary photographic work, but, while in actual operation and guarding his view from foreground intruders, he must be capable of maintaining a steady speed in any hand-fed machine. Still let us imagine that the perfect operator has exposed a perfect film; much has to be done before the picture is ready for projection. The negative has first to be developed, and the ordinary amateur who finds a difficulty in keeping his finger-nails from damaging the films of four plates in a single dish may well stand aghast at the idea of a curvilinear celluloid reptile seventy feet long, so minute in detail as to render judgment of density difficult, and demanding to be uniformly developed throughout.

Of the many methods proposed for development, certain may be taken as types, but as regards the developer only one rule applies. It must be non-staining. Otherwise, in this, as in all other branches of photography, one man's meat is another man's poison; and the golden rule, here as elsewhere, is to find a developer that suits personal methods, and stick to it. It is obvious that commercial development is a far different process from that adopted for the occasional treatment of single kineto-films, and it is perhaps as well to describe the wholesale system first. A glance at Fig. 208 will show the necessity for a developer which does not oxidise rapidly, especially when the method of development illustrated is employed. It will be seen in the Mutograph dark-room that a number of skeleton reels, three feet in diameter and seven feet

long, are loosely mounted on upright standards at the ends of shallow troughs. The undeveloped negative is wound round the drum, by the rotation of which it is continually passed through the developer contained in the trough. When sufficient density is obtained, the whole reel, with its negative, is lifted off the standards and passed in succession to the washing, fixing, and final washing troughs, a water spray being frequently employed in addition. During the final washing a treatment with glycerine is recommended, in order to preserve the flexibility of the film and prevent undue

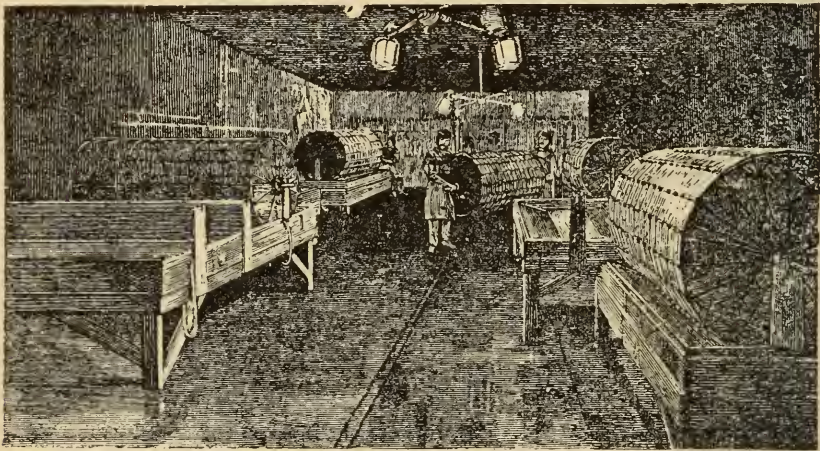

FIG. 208.

curling. Mr. Blair prefers to use glass drums upon which to wind the film, its ends being secured by clips. He further recommends that each drum should be kept for its own trough and solution, the film being wound from one to another at each stage of development, each drum being larger than the one preceding it. By this means the film is secured from overlapping. In addition, a ruby incandescent lamp inside the glass cylinder enables judgment of density to be rapidly and easily formed. Glass drums are especially to be recommended for development, on account of the

security they offer with respect to cleanliness. It has, however, been suggested that when one drum is used throughout all operations the end-clips employed by Mr. Blair should be dispensed with, and a number of small cork pads (held in depressions in the surface of the glass drum) used instead, the film being pinned to the pads at intervals along its length. This plan of pinning-down is largely adopted with drums of other patterns, made of varnished wood. These may be composed of a number

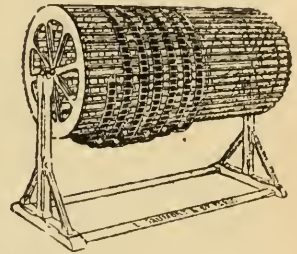

FIG. 209.

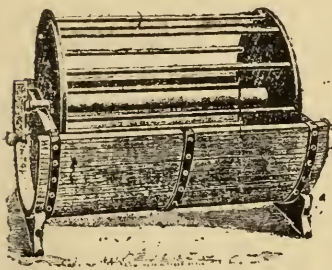

FIG. 210.

of longitudinal slats, in contact or separated, the chief consideration being the ease with which the apparatus can be cleaned. Messrs. Gaumont's drum is shown in Fig. 209, while another form constructed by Messter is of somewhat different design (Fig. 210). A

form described by Marey (Fig. 211) has two drums, P, on which the film, F, is wound in spiral, passing from one to the other. The drums do not themselves enter the developer, but the film is carried down and under a roller, G, immersed in the developer trough, D. Single films

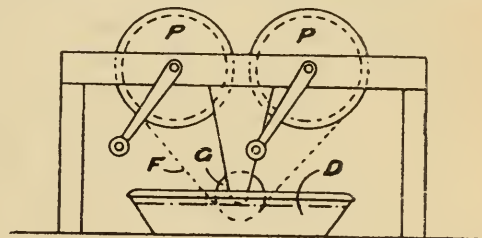

FIG. 211.

may also be passed as an endless band through a long trough, as seen in Fig. 212, and an adjustable winch-clamp (Fig. 213) made by Messter may be used in the same way, the barrel of the handle driving the film.



When a large number of films is not required to be dealt with, methods are generally adopted which allow the treatment to approximate to those in vogue with

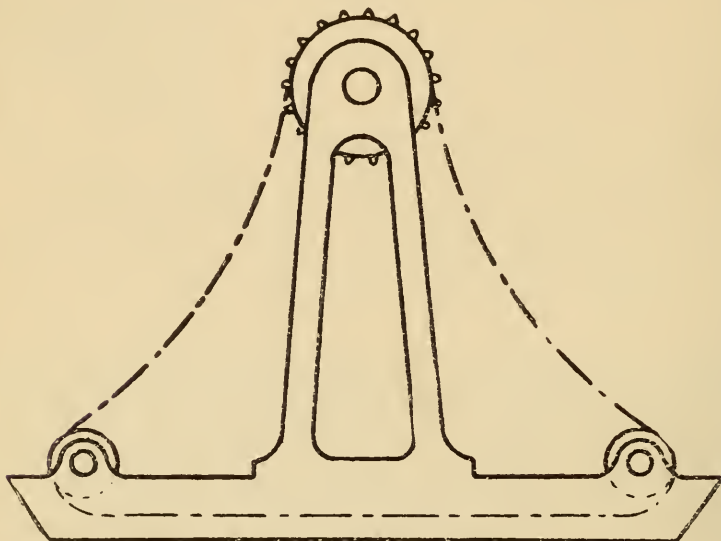

FIG. 212.

single glass plates. For instance, a flat board bearing a number of pegs in a spiral on its upper surface allows the film to be stood on edge in a winding line between the pegs, or a four-armed cross

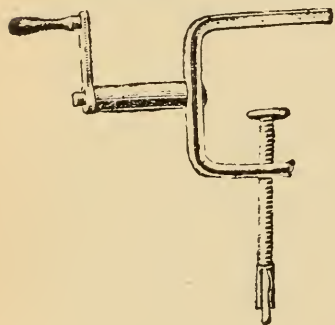

FIG. 213.

(Fig. 214), pegged in the same way, may be employed, the film being wound tightly round the pegs. The arrangement of the pegs may be varied according to requirements by the employment of Hanau's device with movable pegs, shown in Fig. 215, Mr. Birt Acres uses a square frame such as Fig. 216, round

which the film is wound, being kept in position by small wooden teeth which enter the film perforations each time the film passes over the top or bottom edge. This



form is suited for stand development in a vertical bath. The most primitive method is shown in Fig. 217, the film merely being passed from hand to hand in a capacious bath made by Gaumont. It is needless to say that the developed negative may be intensified or reduced in the usual manner.

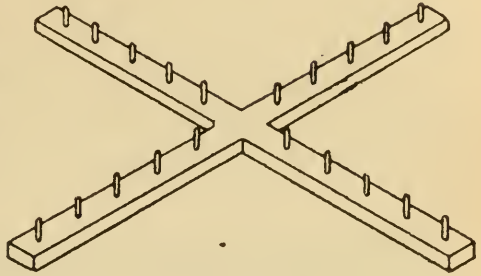

FIG. 214.

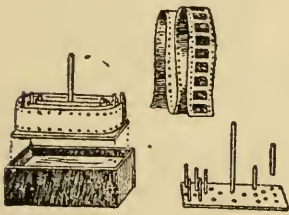

FIG. 215.

The negative, exposed, developed, fixed, and dried, is, of course, only a means to an end; a positive must now be made from it. In this series of operations even more care is required than in the production of a negative. When bands of any substance are subjected to the action of solutions and incidental strains there is always a

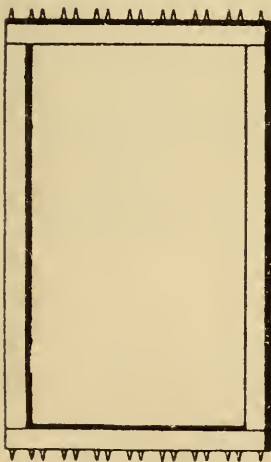

FIG. 216.

risk of irregular stretching or shrinkage, and any error due to this cause is liable to be doubled in intensity by the time the positive is completed. In addition, the pictures should stand at mathematically equal distances

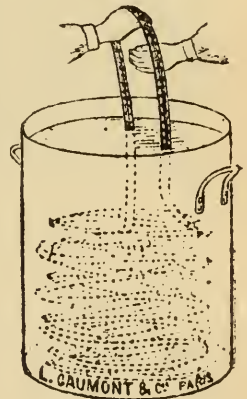

FIG. 217.

apart, and any looseness or irregularity in the printing may cause a variation, first in one direction, then in

the other. The result is a slight want of registration between successive views, giving a most annoying, irregular, tremulous motion to the picture when projected on the screen. Perhaps the best printing machine for large-scale work is that devised by Mr. Jenkins. It will be seen from Fig. 218 that a sprocket-wheel holds the two films in absolute registration, each

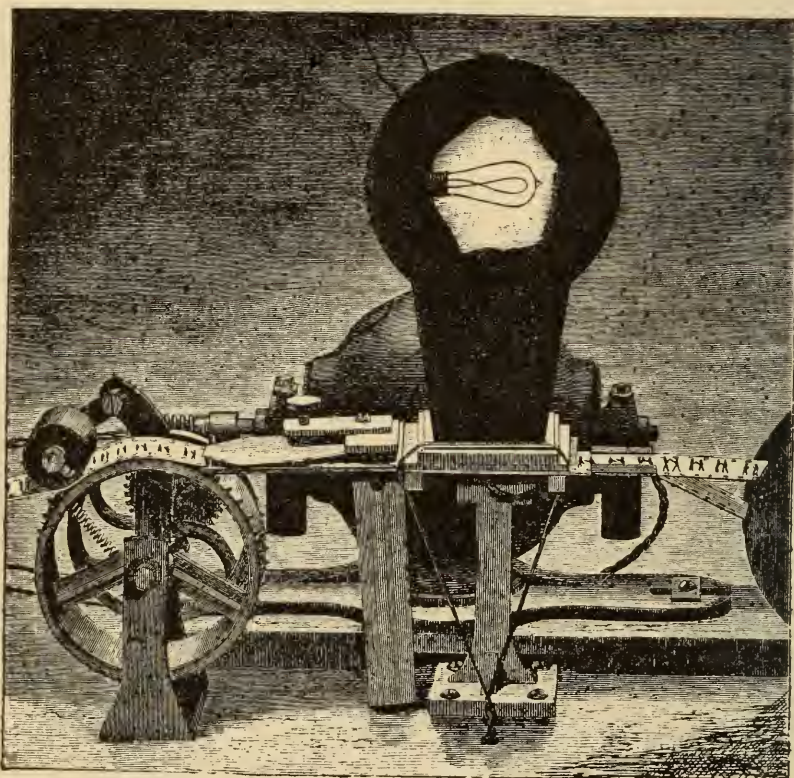

FIG. 218.

film passing independently and continuously from one spool to another, but held in close contact, negative uppermost, between two plates under a shielded incandescent lamp. The exposure is varied, not by altering the rate of travel, but by the insertion of various slotted cards under the lamp at such a distance from the negative that the light is diffused, or rather

spread, before reaching it, the quantity of light being regulated by the size of the slot.

In addition, as mentioned in the previous chapter, many machines constructed for use as cameras and projectors may also be used for printing. This is notably the case in apparatus fitted with claw mechanism for moving the film, the registration then being absolute, while if the negative and positive bands lie one over the other on a curved sprocket-wheel there is more tendency

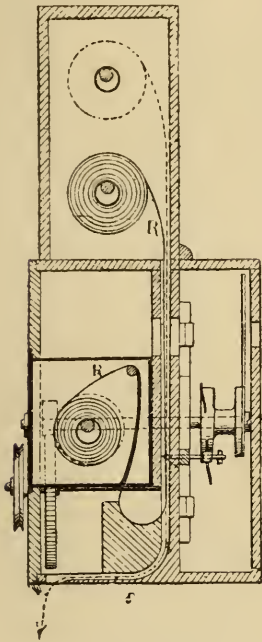

FIG. 219.

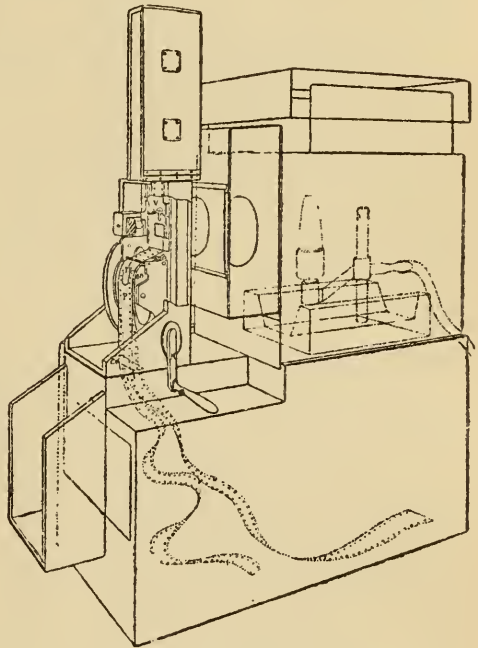

FIG. 220.

to variable strain and consequent irregularity. For instance, Fig. 219 shows Lumière's Cinématographe printing positives on a film, R, which passes into a light-tight box, being clawed down picture by picture in contact with the negative band, which passes through the machine by the usual channels. Another arrangement for use with the Demeny Chronophotographe is shown in Fig. 220. The films are passed through the machine at a regular rate by means of the sprocket-



wheel, the dog being removed. A plate pierced with a narrow slot is substituted for the shutter, and exposure takes place at this aperture, the two films

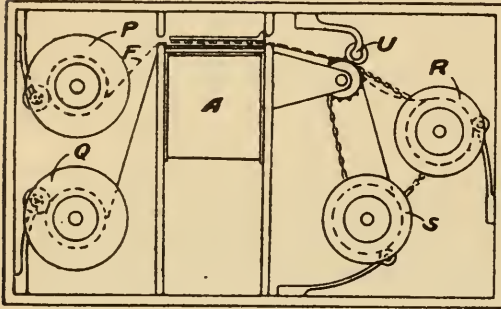

FIG. 221.

passing into a light-tight compartment in the base. M. Marey employs a continuous - travel printer, of which Fig. 221 is a vertical section. The negative passes from spool Q to spool S, the positive film travelling from P to R. Both take-up spools are driven at the same rate by chain-gear, and the two films, negative undermost, are pressed in close contact with a shelf over which they pass, and through an aperture in which light is thrown by an inclined mirror, A. M. Joly suggests bringing the two films from their spools over small rollers, E (Fig. 222), through an inclined guide, F, and exposing them to the action of light from an incandescent lamp as they pass in front of a narrow aperture and over a sprocketed roller, by which they are both driven.

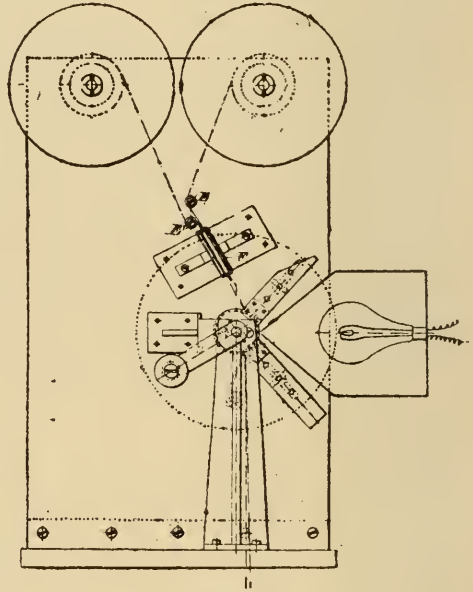

FIG. 222.

For printing special positives for alternate projection the film and negative must be run through intermittently, the aperture being



blocked as each alternate picture comes in position ; the two films are then shifted and run through again, so as to print the missing alternate pictures in the non-exposed alternate spaces.

The development of positives is conducted in the same manner as that of negatives ; but the different character required in the resulting film necessitates consideration. Density and gradation must be carefully watched ; light is of extreme value in living-picture projection, and the image must therefore be kept thin. At the same time all detail must be secured and some deposit be present over the whole extent of the picture ; white spots and sparkling points have a distressing habit of drawing attention to the failings of flicker and incorrect registration, even when only present in a slight degree. Development and drying ended, the film is ready for projection, subject to such improvement and rectification as retouching can supply. Flaws and spots are fatal. In a single picture they are detrimental enough, but their presence on a film of successive views gives rise to a twinkling and twittering effect, due to their sudden perception and equally sudden disappearance, which is irritating and fatiguing to the eye. Colouring is sometimes added ; on this subject special words of caution are necessary. In an ordinary single lantern slide outline is of little moment, in a Living Picture it is everything. A spire of a church in the single view does not offend the eye if the colouring oversteps the proper outline, provided that the shape is rendered symmetrical. Far other in a Living Picture. The slightest variation between successive views gives rise to a continuous bulging and contraction which no respectable church would allow its steeple to indulge in. Illusion of the movement of objects is due to alteration in position of their outlines as compared with that of stationary objects, and this progression is

minute in successive views. The slightest inaccuracy in colouring may neutralise this, and render the steps by which an object is apparently advanced far more jerky than is the case in the photographic views. Therefore, so far as regards the actual colouring, it should be of the nature of tinting rather than partaking in the gaudy display of the average lantern slide. Further, it should be done with extreme accuracy; better no colouring than a spoiled film, and those who do desire colour must prepare to pay the price which alone can secure a proper result. It is possible now, however, to procure films coated with almost as great a variety of emulsions as in lantern-slide work; and the use of a chloride of silver film will often give a warm appearance to a hard picture which would present an absolutely wintry aspect in black and white, while the variety of colours obtainable, used with discretion, is of the greatest service. The application of ordinary triple-projection has been suggested for the production of natural-colour Living Pictures, but the loss of light involved is at present a bar to success.

As regards the protection of films, little has been done. Machines are constructed with the greatest care, and every precaution is taken against damage to films in course of projection; but where will the lantern-slide maker be found who sends out his wares without cover-glasses? It has been proposed to cement a plain film by its edges over the positive. Of course this would double the thickness of the film, and it is well understood that celluloid obstructs light to a greater extent than glass; and if anything be attempted in this direction it would appear better to confine the attempt to the strengthening of the margins, leaving the security of the picture surface to be attained by perfecting the construction of the film-gate.

Repairing celluloid films is unfortunately an operation

which requires to be somewhat frequently performed. The film may be torn right across; in that case one picture must be sacrificed. The perforations may become damaged; and then they must be replaced, or a sideway strain will be placed on the film, which will inevitably result in rupture of the band sooner or later. The two solvents for celluloid are amyl acetate and acetone, the latter being, according to general opinion, somewhat preferable. Either of these two fluids may be used, or a cement employed consisting of a solution of celluloid in one of the two above-mentioned bodies. The ends of the broken film must be trimmed so as to render the two proximate pictures at a correct separation, the junction being freed from

grease and film, and scraped down so as not to leave an abrupt thickening where the edges overlap. The cement is applied, and the two edges pressed firmly together between greased glass plates. The same process answers for the insertion of a

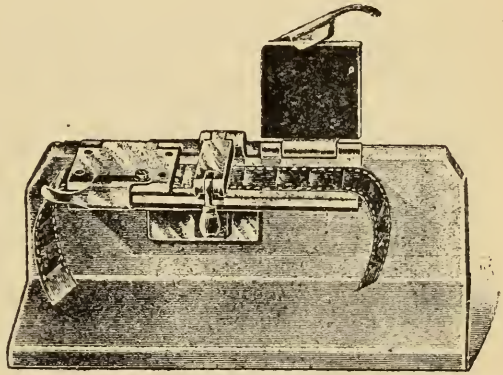

FIG. 223.

fresh portion of perforated margin, and an incipient tear may be covered by a layer of extremely thin celluloid in the same manner. Even in this comparatively small detail of manipulation facilities are afforded which were unthought of two years ago. Fig. 223 shows a film-mender brought out by Mr. W. C. Hughes, in which the broken ends may be fixed by the side clamps so as to ensure perfect registration of the perforations. The ends are then scraped,

cement applied, and the centre clamp turned down to hold all firm until the cement sets.

Here, then, the film passes into the exhibitor's hands, and any further remarks regarding it must be relegated to the next chapter, wherein are described those few accessories and aids which render the exhibitor's life endurable, if not happy.



## CHAPTER VI.

### EXHIBITING HINTS, ACCESSORIES, LIGHTING, ACCIDENTS, ETC.

THE first requirement in the projection, as in the taking, of Living Pictures is absolute rigidity of the apparatus. It must be remembered that enlargement of the image on the screen is greater than in ordinary projection work, while the apparatus itself is subjected to treatment which no mere optical lantern is called upon to undergo. The needful rigidity may be secured by the use of a special stand, such as Griffin's (Fig. 224), or the one supplied with Messter's "Apollo" Kinetograph (Fig. 225).

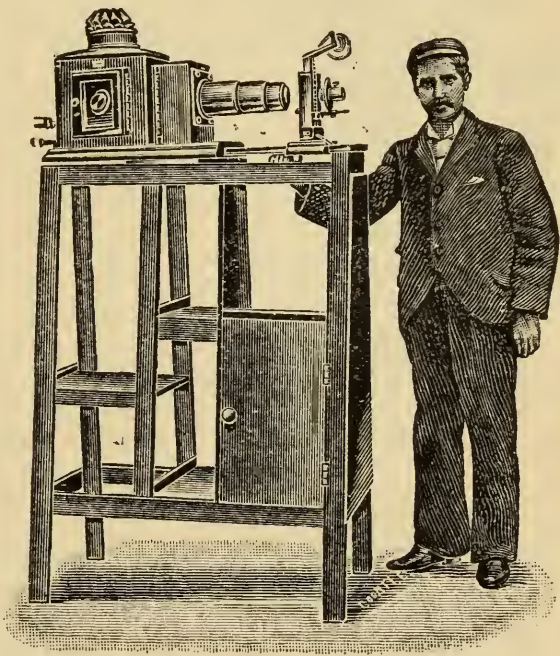

FIG. 224.

On no account should any hollow body be used as a support. It is not sufficiently recognised how large a degree of sympathy exists in many organisations between one sense and another. There is little doubt

but that a continual rattle impinging on the ear tends to intensify irritation caused to the eye by flicker on the screen, and it is towards the minimising or concealment of this same flicker that attention is at the present time most strenuously directed. This objectionable phenomenon is traceable to the fact that the picture is periodically cut-off from view, a state of affairs which, of course, does not obtain in natural vision. It must be remembered that though persistence

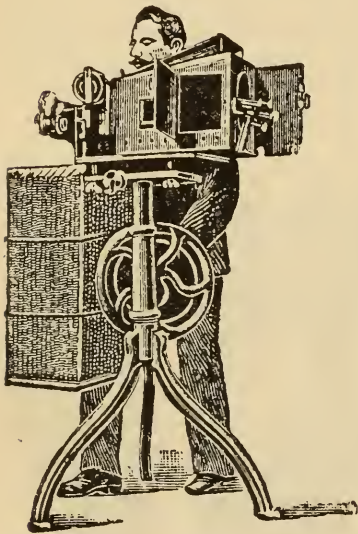

FIG. 225.

of vision ensures the continuance of one image until such time as another is received, yet the impression does not continue in its full strength, and the general result is therefore a perpetual increase and decrease in the brilliancy of the picture as perceived by the eye. Furthermore, the decrease of light is progressive, but every fresh view is presented in full brilliancy. Flicker might probably be reduced to a considerable extent if a vignette edge to the shutter gradually admitted light to the screen

at a similar rate to that at which it naturally fades from the eye. The type of machine designed to project one picture before the light from the preceding one is cut-off will probably remove flicker; meanwhile several makers have proposed to do away with the shutter, substituting (as Wheatstone did, page 15) a period of very rapid travel—so rapid, indeed, that a general blur takes the place of that darkness which is in other cases caused by the shutter. This expedient would doubtless be successful were the pictures of

uniform tint all over their surface (that is to say, if they were not pictures at all), but as high lights are a necessity in all lantern or other views, their continual passage across the screen gives rise to that "rain" effect usually associated with damaged films. It must not be forgotten that a perception of this kind persists as well as any other; the eye has no power of applying a physiological function to artistic impressions and throwing it out of action in other cases. Still the merits of this course of proceeding are purely relative, and if the period of change be very rapid there is no doubt

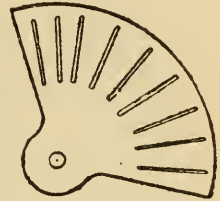

FIG. 226.

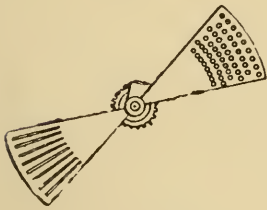

FIG. 227.

that with the majority of views a shutter may be dispensed with. Some makers have adopted a medium course, and neither entirely cut off the light nor permit the changing view to be seen. Thus a segmental shutter may be pierced with slots (Figs. 226, 227) in order to allow enough light to reach the eye to keep it employed, so to speak, until the next view is rendered visible. Wire-gauze or small holes, as in Figs. 227 and 228, may serve the same purpose, while it has been suggested that a translucent substance pleated as in Fig. 229 is of sufficiently varying opacity to act in the same manner. A double rise-and-fall shutter, the two parts of which are worked by cams, has also been described, but practically all shutters are rotary. One form is shown in Fig. 230, and is so shaped that the edges travel across the

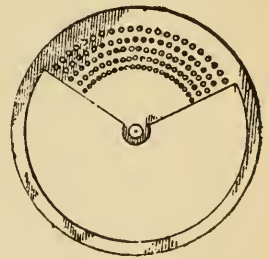

FIG. 228.

screen parallel to the margin of the view. Another usual form is that of Fig. 231, in which the rotating box



FIG. 220.

acts as a light-tap. The shutter and its varied failings are, in fact, a weariness of the flesh; its apertures must be so exactly proportioned, not only to the required exposure of the picture, but also to the degree of flicker which can be endured; its rapid rotation so intensifies the slightest want of balance that there seems great scope for improvement. It is greatly to be regretted that loss of light precludes the employment of an arrangement such as is used in Bashforth and Crehore's polarising chronograph, wherein a polarised beam of light is rotated by electro-magnetic action to such a degree that it cannot pass through the second prism. This is an ideal shutter, instantaneous in action, weightless, and therefore vibrationless, but utterly impracticable in Living Picture work until a far more powerful source of light than any yet employed is discovered.

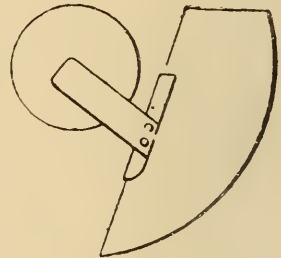

FIG. 230.

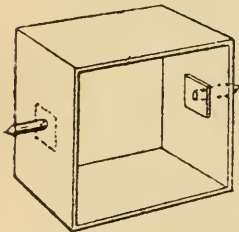

FIG. 231.

be well if the shutter could in most cases be entirely disconnected from rigid connection with the rest of the mechanism, to which it is apt to communicate a vibration, slight in itself, but quite sufficient to cause a tremulous motion of the picture on the screen. All these vibrations and flickerings are to a great degree concealed by the use of an ingenious apparatus invented by M. Gaumont, who introduced it to the notice of the Société française



de Photographie on the 4th of June, 1897, under the name of "*La Grille*." It is a black fan of any convenient shape (Fig. 232), pierced with a number of small holes. When the fan is put in rapid motion, and the picture viewed through the holes, flicker is almost entirely eliminated. The inventor does not seem to have put forward any theory respecting its action, neither does any one else appear to have suggested a reason why it should prove effective; indeed, as the subject of flicker itself is still under debate, it seems rather rash to theorise upon the Grille. Yet, if flicker be due to rapid changes of brilliancy in the picture, one view



FIG. 232

gradually fading and then being suddenly replaced by one of maximum intensity, it is possible that the Grille is unconsciously vibrated at such a rate that it cuts off some of the light from the most brilliant period, and so tends to render the illumination more even. A very good substitute for the Grille is a black-gloved hand,

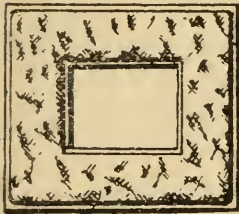

FIG. 233.

with fingers slightly opened, vibrated somewhat rapidly before the eyes. No doubt, if "fingers were made before forks," they are far anterior in point of time to the Grille, and though the employment of the "Kinedodgescope," as it has been humorously called, is more fatiguing than the use of the proper appliance, yet it may often be used to afford a much needed rest to the eye without losing sight of the picture under exhibition. One other trouble is now overcome. The first film-traps were padded as Fig. 233, and pressed on the

film. The utmost care could not keep these pads entirely free from dust, and the film-surface suffered in consequence. But of late nearly all machines either give a pressure on the margins only, or release the pressure on the film during its motion, and the earlier disadvantages of the film-trap thus disappear.

With regard to the correct placing of the picture on the screen, there is no necessity to register the film with the actual exposure-opening. The pictures being placed at regular distances, a gauge may be fitted at any point in the path of the film, and if a picture be accurately set to this gauge, the one ready for projection should be found truly placed in position. Most machines are fitted with a movable frame, which outlines the picture, and which can be adjusted so as to compensate for creeping of the film. As regards placing films in the machine, it must be confessed that this is one of the great trials to which an exhibitor is subject. The best of audiences is impatient of delay, and the substitution of one film for another is no easy matter. To attach the various subjects so that they run on one after the other is a simple method of evading the difficulty, but has the serious disadvantage of preventing the selection and arrangement of certain films for any desired lecture. In some machines the front portion turns on one side to allow the film to be laid in place, the friction-rollers returning to their gripping position when the apparatus is closed.

To fill up the time during the change of film it is desirable to have some arrangement for the projection of ordinary slides, and this course is to be recommended as heightening the effect of Living Pictures by contrast with a motionless one. Of course this end may be attained by the use of a second lantern, or some means of deflecting the light through a second optical system of the usual projection type; but probably the most

efficient and convenient method is that shown in the '08 Bioscope (page 134), where it will be seen that a turn of the front table puts an ordinary 7-inch objective in place, and at the same time places the kinetographic portion of the apparatus in a convenient position for film-changing.

Whatever plan is adopted on the score of rapidity, an automatic rule should be followed to make sure that the right end of the film is placed first in the machine. In all projection work the rule for obtaining a correct image on the screen is *film side upside-down to the condenser*.

Lantern-slides now almost invariably bear two white spots at the top of the film side, and if these appear downwards towards the back of the lantern, the picture is bound to be correct on the screen. So with

kineto-films, a mark of some description should be made on the film side at that end where the last picture has sky or heads of figures outwards, and in winding films the unmarked end should be rolled on first. Placing the film side towards the projection-lens reverses the picture from right to left—not a serious matter as a rule, unless a well-known landscape or any lettering appear on the scene. But this error is apt to

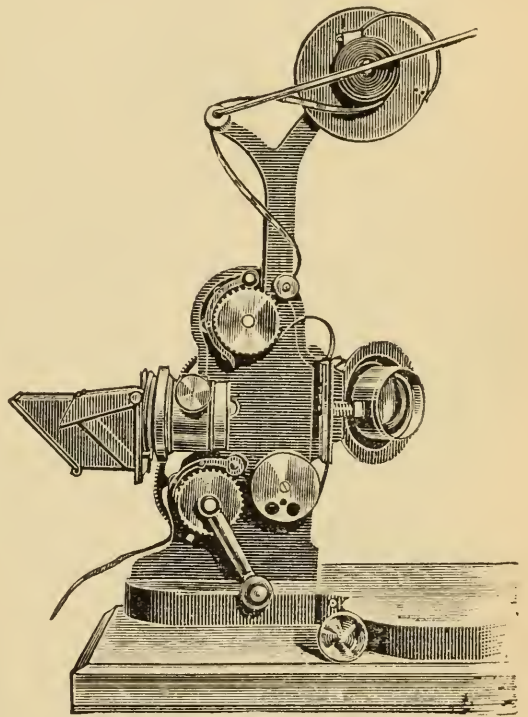

FIG. 234.



cause strange effects in other ways. For instance, at one entertainment, Ranjitsinhji was shown batting in grand style—*left-handed!* Not a likely experiment for an Australian test-match, it must be confessed! But the operation usually known as reversing consists in passing the film backwards through the machine, thus presenting the effect reversed in point of time. For instance, a reversed diving-scene will show an

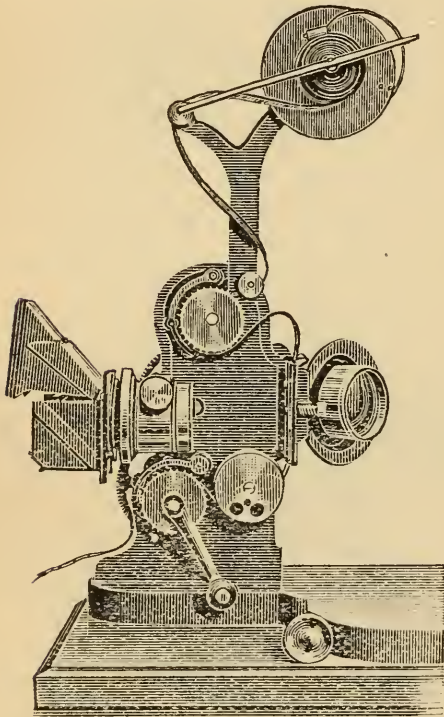

FIG. 235.

existing splash which gradually dies down, and from which emerges a man, feet uppermost, who in this attitude makes his way to the diving-board from which he should have started. The usual way of working this is as previously stated; the film is run backwards, not by a reverse motion of the machine, but by starting at the wrong end of the film. Consequently the view would be upside-down on the screen, but a reversing-prism is used to erect the image in the same

manner as in a science lantern. Such an appliance, made by the Warwick Trading Company, is shown in Fig. 234, and it will be seen that the prism may be thrown up out of the way in a moment (Fig. 235). Some few machines have reversible mechanism, in which case no prism is necessary, the film being merely run backwards from the lower spool to the upper, while Newton's machine, though not reversible,



solves the difficulty by inversion of the whole apparatus.

After a film has been exhibited it always requires rewinding in order to bring the first picture outside. A convenient form of winder is illustrated in Fig. 236; the spool is placed on the spindle, which revolves so rapidly that the operation is complete in a few seconds. Most machines are fitted with receiving spools for the films, but of course the film needs to be rewound all the same, and the extra delay caused by attaching each picture to the spool has resulted in a general adoption

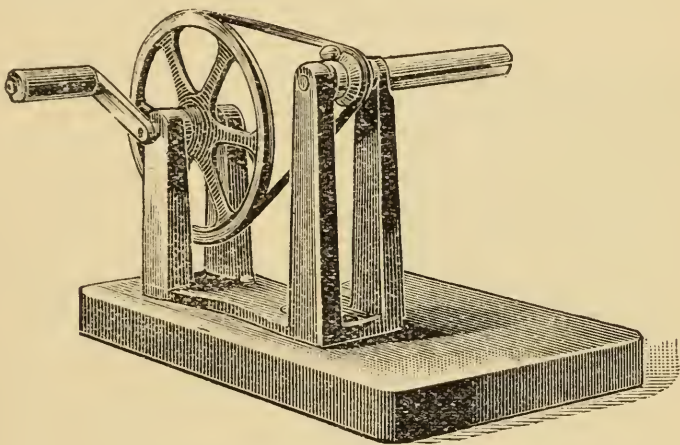

FIG. 236.

of the practice of allowing the film to run free out of the machine into a basket, from which it is rewound at the conclusion of the entertainment. This plan, however, has its disadvantages. Films are somewhat tender things, and to allow them to lie in a loose heap is not conducive to long life. They may be run into a bag; but probably the best course to adopt is the employment of a collapsible box furnished with a slit, somewhat like a letter-box; the rigid sides prevent pressure on the films, and the whole folds into a very small space for transport. Further, this plan is

to be recommended on the score of safety. It must not be forgotten that celluloid is inflammable to a high degree, and up to the present no means have been introduced to neutralise this tendency without at the same time impairing transparency, though the addition of chloride of magnesium is said to promise good results. If the heat of the lantern should ignite the film at the exposure aperture, the flame is likely to be stopped from spreading by the friction-rollers, etc., through which the film passes, but if a spark fall into the basket directly under the machine, the loosely packed celluloid, interspersed with air-passages, would give rise to a conflagration so sudden and so energetic

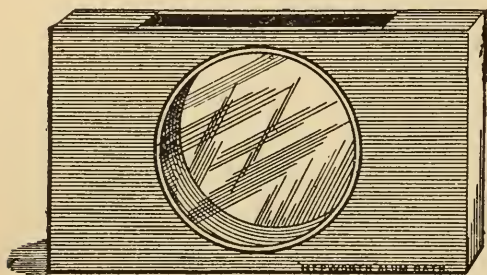

FIG. 237.

as to almost equal an explosion. It will therefore be seen that the enclosure of loose film is an absolute duty. As regards the risk of lighting the film by the heat of the lantern, it is usual

to interpose an alum-trough (Fig. 237), as in photomicrographic work, where a large number of rays are concentrated on a small object. Glycerine has also been suggested as an exceptionally effective heat-absorbent. In addition the suggestion has been made involving the employment of a shutter covering the condenser, to be lifted when the film commences its motion, and dropped so soon as the end is reached. This shutter might be pierced in order to give sufficient light for the adjustment of the film. Messrs. Lumière have introduced an ingenious condenser, which serves at the same time to absorb the heat-rays. It will be seen from Fig. 238 that a spherical flask of water is used as a condenser, a small piece of carbon being

suspended therein to draw off the gases set free by the gradual heating of the contained water. In addition a

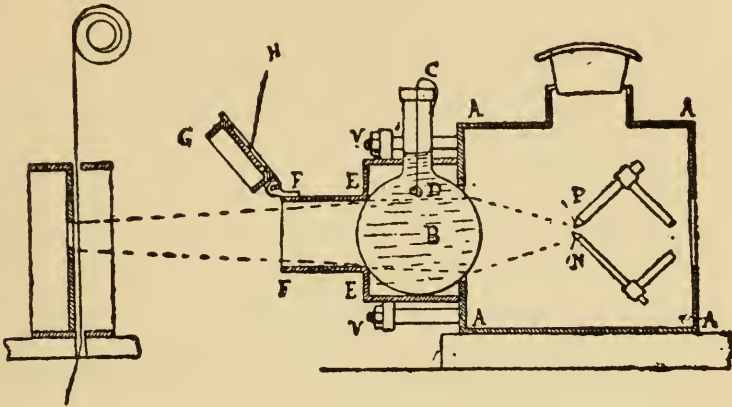

FIG. 238.

ground-glass shutter, H, is provided for use when the film is stationary. Another condensing arrangement (Fig. 239) provides for the circulation of the water from the condenser to a tank with the object of keeping its temperature within reasonable limits. The film itself need only be exposed for a short distance if the spools be enclosed in metal boxes such as Fig. 240. After inserting the film in the spool-box, the lid  $L^1$  is shut and the film led out through the padded aperture  $L^3$ , the flap  $L^4$  being hinged and closing by its own weight.

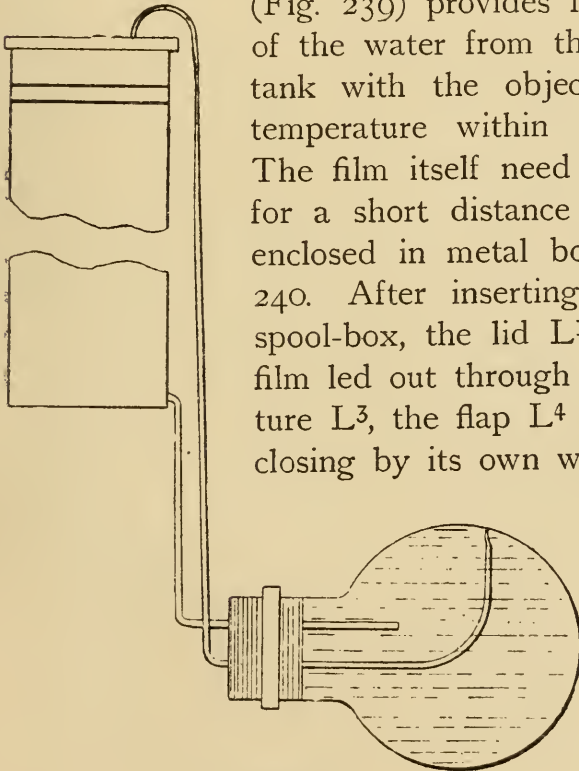

FIG. 239.

This question of the inflammability of celluloid is the only one which affects the safety of Living Picture machines

*per se*; other causes may result in catastrophes, but they are common to all projecting apparatus. If a gas-cylinder bursts, that surely cannot be attributed to the projecting apparatus; such things may occur at any lantern show; in fact, the most sensational accident of this description occurred at Fenchurch Street railway station, in the absence of any lantern whatever.

As regards the question of lighting, it is somewhat out of place here, being common to all branches of projection work, and it is manifest that the system of lighting employed need not, and, indeed, does not, affect the mechanism employed for the presentation of

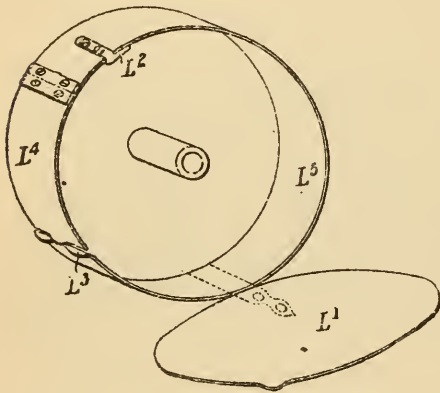

FIG. 240.

Living Pictures, although its power has a considerable influence on the result when shown on the screen. Still a few general principles may be suggested. For safety and power the arc-lamp is pre-eminent, and with the rapid extension of public electric lighting it should not be long before

current is available in all large lecture halls. If electric light cannot be employed, a good mixed-jet limelight should be used, and here again danger is practically absent. It is certainly better to face the cost of carrying a second cylinder containing hydrogen than to employ an ether-oxygen light. Not that this light is dangerous if properly employed, but a slight error in its manipulation may lead to fatal results. It is undeniable that the more serious accidents at Living Picture entertainments have resulted from the employment of this light. The terrible catastrophe at the Bazar de la Charité is still fresh in all memories, and while admitting that the



operator was in fault, and that he was culpably ignorant or forgetful in endeavouring to refill his ether reservoir in the neighbourhood of a light, it must not be forgotten that a similar amount of carelessness in the use of an oxy-hydrogen limelight could not, with gas in cylinders, have led to similar fatal results. It has been suggested by Mr. Hughes that certification of public operators is the best solution of the difficulty, and there certainly appears to be considerable force in his contention.

As an indication of the maximum precautions advisable, the rules promulgated by the leading British fire insurance companies may be of interest, and it is noticeable that the ether-oxygen light is entirely prohibited in this country (so far as recovery of fire-loss is concerned), while a similar prohibition does not appear to have been yet made on the Continent.

#### RULES.

- (1) The lantern must be constructed of metal, or lined with metal and asbestos.
- (2) An alum or water bath must be used between the condenser and film.
- (3) The apparatus must be fitted with a drop shutter available in case of emergency.
- (4) If the film does not wind upon a reel or spool immediately after passing through the machine, a metal receptacle with a slot in the metal lid must be provided for receiving it.
- (5) If electric arc-lights are used, the installation must be in accordance with the usual rules, *i.e.*, the choking coils and switch to be securely fixed on incombustible bases, preferably on a brick wall, and d.p. safety fuses to be fitted.
- (6) If oxy-hydrogen gas is used, storage must be in metal cylinders only.

- (7) The use of an ether saturator is not to be permitted under any circumstances.

#### POSITION.

Preferably on an open floor with a space of at least six feet all round railed off. If in a compartment, the compartment to be lined with fire-resisting materials. In any case no drapery nor combustible hangings to be within two yards.

#### GENERAL.

Fire-buckets to be kept filled, and a damp blanket to be provided and placed close at hand.

One other subject in connection with lighting demands attention. If it be difficult to secure sufficient light in the lantern, it is at any rate a comparatively simple matter not to waste that which is thrown on the screen, and every method applied with this view to ordinary lantern work is of far greater importance when Living Pictures are in question. The ordinary linen sheet, which allows a considerable quantity of light to pass, should be placed entirely on one side, and an opaque screen used instead. Should the question of portability enter into the matter, the plan of whitewashing the sheet, or rather dipping it in weak whitewash, should be employed. The screen may be quickly rough-washed and placed in a waterproof cover so soon as the entertainment is ended; but in all probability the new silver-surfaced screen lately introduced by Anderson will effect the most saving, as it diffuses considerably more light than any other surface yet employed.

Naturally the lenses employed, whether for photographing or projecting, should be of the best; high magnification demands good covering power, while the necessity for economising light requires large apertures.

Such flat field lenses as Dallmeyer's Stigmatic, Zeiss' Anastigmats, or Busch's Aplanats are good examples of the class of lens referred to; the latter also showing some ingenious methods of interchangeable mounting, helical focussing, etc.

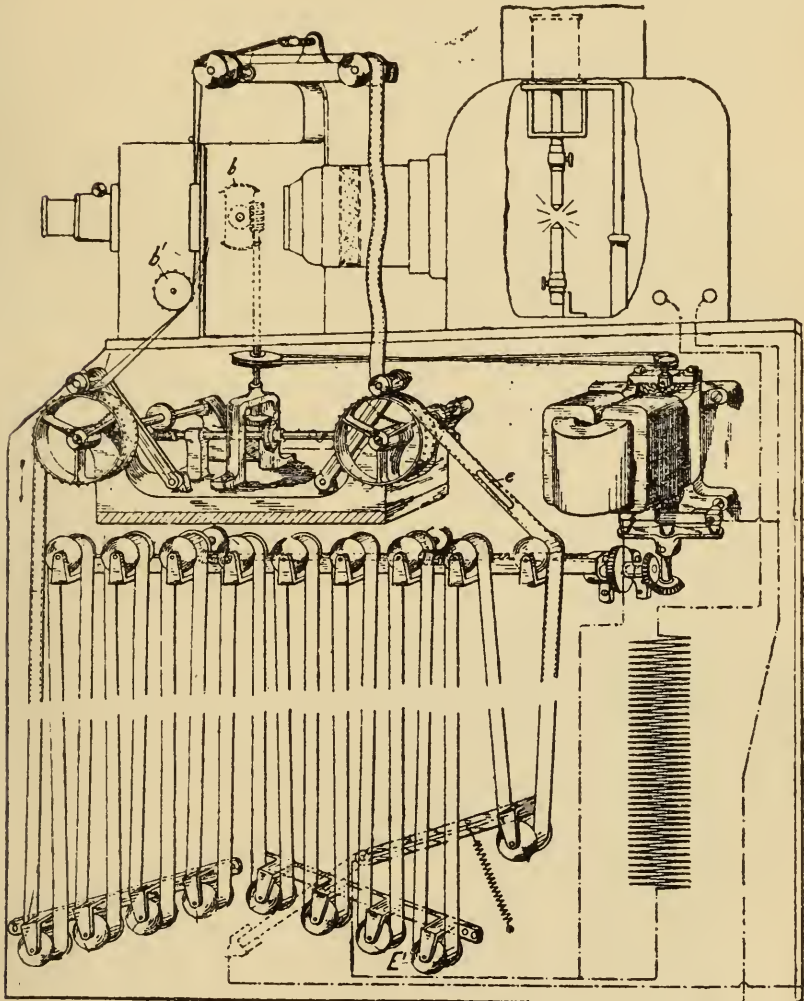

FIG. 241.

So far reference has been made only to ordinary exhibiting, but Animatography has also, despite its youth, struck into several bye-paths. Commercial energy at once seized on the Living Picture for purposes.

of advertisement, and though in general the ordinary methods of projection have been followed, yet attention has nevertheless been paid to this phase of the whole question. Fig. 241 shows an apparatus designed by Mr. Hepworth, which dispenses with the continued presence of an operator. It will be seen that a spool-bank is employed as in the Kinetoscope, but the film is led upwards so as to pass between condenser and projecting-lens, the central shaft also being carried up to work the shutter. The whole arrangement is electrically operated, and a slot at *e* permits contact to be made in order to stop the machine at the end of a scene. A jockey-roller is also provided, so that if the film tightens by reason of some accident the roller rises in order to break the current.

As regards the minor methods of exhibition, many instances have already been quoted. The Mutoscope has attained great popularity, while the Kinetoscope

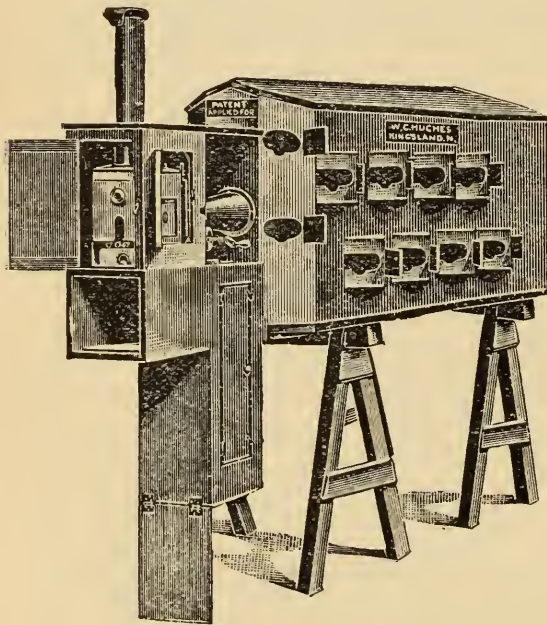

FIG. 242.

has been modified in several ways in order to render the scene visible to several observers at once. The most ambitious of these devices is probably Joly's Photozootrope, in which the band is run past several eyepieces and illuminated by a central light and revolving slotted drum, somewhat as in Fig. 112. Two



bands, one below the other, are employed, and either may be brought opposite the eyepieces by the action of a lever. Each of these bands is 110 mètres long, and contains two scenes. But projection has also been employed for "peep-show" purposes. Mr. Jenkins arranged a show in 1896 in New York; a "penny in the slot" freed the eyepiece and started a machine projecting a view on a screen. Recently a somewhat similar arrangement, worked by the Micrograph Company, has been on view in London. But these affairs were structural, while Mr. W. C. Hughes' "Photrotoscope Peep-show," on the contrary, is extremely portable. As seen in Fig. 242, an oil-light may be employed to throw a three-foot picture on a proscenium at the inner end of a box provided with twenty eyepieces. This apparatus is collapsible, and takes only ten minutes to erect, so that it may be used for street exhibitions, etc., while the machine itself, separated from the peep-show box, is perfectly efficient for use in large halls.

As regards the choice of subjects for an entertainment, it is well to bear in mind the story which recently set the lantern world smiling at the perplexity of a minister who found himself taking the chair at a prize-fight, and who could find nothing in the programme to suit his cloth, with the single exception of "Feeding the Baby"! It is a simple matter to obtain a preliminary approval of the proposed views; and the variety placed at the disposal of operators affords every facility for making a happy selection. What garrison town would not be contented with the opportunity of viewing scenes from the military life of other lands, to say nothing of the glimpse which might be afforded of actual warfare? In fact, not only may the proximate past be placed in action on the screen, but acted historical scenes, far earlier even than accurate pictorial records extend, are

at the service of any suitable audience. If memory be not at fault, even the Nativity is procurable for exhibition purposes, or it may be the Adoration of the Magi; at any rate, chronologically speaking, the view in mind is there or thereabouts. In fact, some of the more recent films may prove to be sorely puzzling to the much quoted New Zealander of the future, who, discovering a Living Picture machine and films in the neighbourhood of ruined London Bridge, shall endeavour to reconcile the accepted date of the invention of the Living Picture with the existence of a chrono-photographic record of the birth of Christ. Still to the present-day archæologist means are available for bridging a gap of a paltry nineteen hundred years, and the true inventors and improvers must take their chance of having their labours ascribed to the ancient Romans by the historian who is yet to be. At all events, for the present there is little doubt to whom the credit should be awarded; and in the next, and final, chapter it will be endeavoured to shortly summarise the whole life of the Living Picture.

## CHAPTER VII.

### PAST, PRESENT, AND FUTURE.

THE enquiry has often been made, "Who was the inventor of the Living Picture?" This question has usually been answered, if answered at all, by dogmatic assertion or the presentation of isolated facts; there has been no attempt towards a logical determination of the problem in its widest sense. In the first place some definition of terms is required; let us determine what a Living Picture is. Where shall the line be drawn? If we consider it merely as a view presenting the illusion of motion, then we must go back to the early years of this dying century and attribute its origin to Plateau's Phenakistoscope. If we restrict our definition to views of photographic origin, Wenham's experiments in 1852 fulfilled our requirements forty-six years ago. Should it be required that the photographic record be a true analysis of motion, then thirty-four years have passed since Du Mont indicated the methods of chronophotography. Finally, if it be suggested that the picture must last a definite and somewhat lengthy period, the images being secured at short intervals and in a very restricted space of time, we are compelled to admit the Living Picture as a phenomenon of recent growth; but it must not be forgotten that many views of one action, procured by photography and repeated for as long a period as required, were prepared far earlier than any date which may be termed recent. And, further, it must not be ignored that the different stages quoted above led insensibly one to the other;

each step was founded on the labours of previous workers or at least rested on the same basis. No! emphatically No! There is not, there never was, an inventor of the Living Picture. Say that it grew from an infinitely small germ, as unlike its present form as the butterfly is unlike the egg from which it evolves; say that many minds have each contributed, and still are contributing their mite towards the realisation of that perfection yet to be attained; say that the Living Picture is the work of nineteenth-century civilised man—and the statement will be as true as any generalisation can be. So far as a single inventor can be named, Plateau must be recognised as the originator of the pictorial method of producing an illusion of motion by means of persistence of vision. This in a double sense; for while the Phenakistoscope was the forerunner of all machines in which a rapidly moving picture was momentarily viewed (and this definition includes machines so late in time as Edison's Kinetoscope), yet Plateau's "Diable soufflant" was the first step toward all those forms of apparatus in which a picture is momentarily viewed while stationary. True the picture was not stationary, but the principle of differential speed between image and shutter was established.

And to whom could this invention be attributed with more satisfaction? There is no name in the history of physiological optics more worthy of honour than that of this philosopher. Born in 1801, Joseph Antoine Ferdinand Plateau devoted himself early in life to the study of optics, especially in their physiological aspect. At the age of twenty-eight, in the course of some experiments respecting the effect of light on the retina, he exposed his eyes for a considerable time to the full blaze of the sun. The result was blindness, from which, however, he temporarily recovered. During this period



of recovery he invented the Phenakistoscope, and in 1835 was appointed Professor of Physics at Ghent. Over a period of fourteen years his sight gradually deteriorated, and by the year 1843 he was totally blind. Yet in 1849 he invented his *Diable soufflant*, he continued his researches by the aid of relatives who carried out his instructions for experiments to confirm his theories, he pursued his investigations into the domain of molecular physics, he retained his professorship, and died in harness, leaving works still unpublished behind him, at the ripe age of eighty-three. There is a magnificence in the idea of this blind man carrying on his work, sowing the seeds of pleasure to thousands in future generations by means of that sense of which he was himself totally deprived; there is developed a feeling of pride in human power when we think of a man from whose eyes the light was eternally shut out nevertheless converting the brief glimmer of passing events into permanent embodiment, and leaving to others an elaboration of that sense which was lost to him for ever.

Yet it must not be forgotten that Plateau's Phenakistoscope took its origin from investigations on Roget's researches, which in themselves had nothing whatever to do with Living Pictures. So also with the application of photography. Many experimented long before the necessary appliances were ready to their hand. Mr. Wenham tells us that in 1852 he obtained (by posing) a series of views of a man at work; but he also records that when the views were synthesised into motion the subject declared "he never worked like that!" Du Mont in 1861 seems to have first suggested chronophotography, and Janssen apparently first practised it in 1874, but neither could work rapidly enough to obtain a series fit for recombination. The reproduction of animated scenes was thus not possible until photographic

emulsions of greater rapidity were produced ; manifestly photographic chemists and plate-makers must receive acknowledgment of a large share in the invention of the Living Picture. Again, let the most rapid emulsion be spread on glass, it is difficult—almost impossible—to obtain an extended series of views. Bands were suggested for carrying a long series of pictures by Stampfer in 1833 and Desvignes in 1860 ; the idea was in constant evidence from that time forward, but how could it be applied in the taking of a photographic record? Negative paper, improved as it now is, possesses sufficient grain to render it practically useless as a support for one-inch negatives destined to great enlargement, it was still less suitable years ago. Evidently, therefore, the inventor of celluloid should receive his meed of praise, yet not he alone ; celluloid was not invented for the service of the Living Picture, indeed at first it was not suitable for photographic purposes at all. When rendered fit for use as a photographic support, the Living Picture in no way came into consideration ; celluloid was applied at first in the ordinary manner as a substitute for glass plates of ordinary sizes.

Given a celluloid film of indefinite length, the road was opened for the inventors of mechanical appliances which should utilise it. Thus while we find Greene and Evans were the first to publish and produce an effective machine, yet it must not be forgotten that others were working too ; in fact, Messrs. Donisthorpe and Crofts were not two months behind the previously mentioned inventors. Thus throughout the history of the Living Picture names are associated rather with details than with principles, which in fact seem generally to have been pointed out long before the means existed for carrying them to a practical issue.

In fact, throughout the course of the present century

the Living Picture has, in popular parlance, been "in the air"; similar ideas and methods have occurred independently, sometimes simultaneously to separate individuals, and this was almost necessarily so; the facts of the case demanded it. Given a series of connected facts capable of leading in combination to one or two well-defined results; given a number of observers equally interested and of similar capability—it is a practical certainty that several will arrive at the same conclusion, the more so as the field of possibility becomes more restricted. In cases of this kind one observer may reach the obvious conclusion before another; that does not prove his right to a national memorial and entry on the roll of fame; there is credit due to the man who extracts a grain of sand from the machine and so renders it workable; he proves his industry and application, but certainly cannot claim recognition as a genius. In proportion as the elementary facts become more numerous and complicated, so does the discovery fall inevitably to the man of greater capability if the solution be reached by reasoning; if it be arrived at by accident, that is a matter personal to the discoverer—he is not bound to mention it!

To substantiate these views several examples taken from the History of Living Pictures can easily be quoted. Plateau and Stampfer invented the phenakistoscope almost simultaneously. When we consider that the subject of wheel phenomena had been before the world for some years it is not surprising that the popular introduction of the Thaumatrope should have caused the idea of the phenakistoscope to crystallise, so to speak, in the mind of more than one man. To come to later years, a comparison of Acre's English invention of May, 1895, with Müller's German patent of August in the same year will show an almost similar method of dealing with the same problem. This is probably

due to the fact that the solution was a fairly obvious one. Marey had done the same thing less perfectly in 1890; he clamped the film and allowed it to be drawn onward by a spring when the clamp was taken off, Acres and Müller put a roller on the end of the spring. Certainly one device was effective, the other was not; but still in this, as in many other instances, no great natural secret was brought to light. Take another case, this time an application of the cinematograph. It was early recognised that the zoëtrope afforded a means of varying the apparent rate of movement of an object; photographs of birds in flight secured by Marey's photographic revolver were recombined at a slower speed in this manner, for the purpose of leisurely inspection. Yet the subject appears to have exercised a fascination of a widespread character. M. Guërout thought it worth while in 1896 to demand the opening of a sealed packet, deposited with the Académie des Sciences in 1889, in order to prove that he first evolved the idea. Mach, Corday, and others have (or purport to have) photographed plants at long intervals and subsequently combined the views rapidly; much ink has been spilled, much more will be expended, for the idea "is in the air" and will remain there—it is of the obvious.

Every step forward renders the area of known facts wider, and attention is therefore at present more and more confined to detail. There exists an almost bewildering variety of mechanical devices directed to one end by three or four ill-defined paths. Yet the practical stage is attained. If unquestionable accuracy is required, photography supplies it. Therefore the cinematograph becomes a recording instrument of historic importance, and the necessary arrangements have already been taken in England to secure the safety of sealed kine-negatives in the British Museum.



By virtue of these precautions future generations will be able to assist at the Diamond Jubilee of Queen Victoria or the Funeral of Mr. Gladstone; surely an advance on the primitive method of depositing an illustrated paper beneath a foundation-stone! At present steps are being taken in France, by Matuszewski and others, to secure a similarly responsible guardianship of records of historic scenes. As exemplifying the current aspect of history, it may be mentioned that a kinetogram of the Pope's promenade in the Vatican gardens has been considered far more effective than even an official bulletin as an antidote to rumours of ill-health. Yet "seeing is not always believing"; and rescues by lifeboat crews and desperate interior combats in guerilla warfare must be taken with the proverbial grain of salt. In practice there is no limit to the length of scene capable of reproduction; if so minded, one could sit out a three-quarter hour prize-fight at the Aquarium. If sensation is demanded, it is alleged that one may have a strictly private exhibition of an execution per guillotine; but surely nothing more terrible could be desired by the most morbid mind than a view of the disaster at the "Albion" launch, the horrors of which were repeated before an audience at a London music-hall (to the strains of "Rocked in the Cradle of the Deep"!) only thirty hours after the breath had left the victims' bodies.

Science too is utilising cinematography to the full. The solar eclipse, as seen in India, was destined to reappear at command at a multitude of semi-scientific soirées, and it is not to be charged against the cinematograph that this pleasant anticipation was not realised; the undeveloped film was stolen on its journey home. As an instance of the adaptation of the cinematograph to popular science it may be mentioned that, under M. Flammarion's direction, a large terrestrial globe

was photographed during a rotation lasting two minutes. When projected the effect, of course, was that of the earth, as it would be seen by an observer in space, but turning at increased speed. Motion under the microscope has been reproduced by Mr. Watkins' Micro-Motoscope, while some radio-kinetographs were shown by Mr. MacIntyre at a conversazione of the Royal Society. The chief scientific use of the cinematograph will probably be found in its applicability to the study of strains and stresses, a physical action being photographed at a high rate of speed and projected slowly for purposes of inspection. Thus the launch of a ship, or a girder subjected to breaking strain, form ideal subjects for this kind of research, and both these operations have been photographed successfully. *En passant* it may be mentioned that leisurely inspection of a film recording a feat by a celebrated conjurer results in a demonstration of "how the trick is done"; "the quickness of the hand deceives the eye," but does not delude the impartial and accurate cinematograph. Commercially too the cinematograph has its uses. Mr. Freer, last March, at the Imperial Institute, showed a series of films reproducing harvesting in Manitoba in 1897, and doubtless this method of encouraging emigration is capable of great extension. So too there is no doubt but that a military audience finds its greatest delight in witnessing the evolutions of foreign troops; but it may be doubted whether an accurate reproduction of the horrors of a battlefield would to any great extent facilitate recruiting; discretion is required in Cinematography as well as in every other path in life.

Yes, the practical stage is fully reached, but the perfect is yet to come. It has already been declared that accuracy of workmanship has quite as much, probably more, to do with results than the principle

of the machine. Yet, given good mechanical treatment all round, there must be one or two types of existing apparatus which will outdistance the others. Will the shutter remain? How will flicker be overcome? Perhaps by alternate and overlapping projection from two lanterns using one film taken from one point of view. Perhaps also the multiple lens travelling with a continually moving film may prove its superiority. It may be that none of the present types will persist; some new idea may carry the day. The use of a mirror to render a travelling film optically stationary is quite a recent suggestion, and though this single mirror must be returned to its first position as each picture passes, there are more unlikely things than the revival of the praxinoscope type, the mirror-drum, which is in continual rotation in one direction, needing no return and rendering all images optically stationary. So too the suggestion of a continually revolving camera, taking a continuous view of the whole horizon or such part as is left unshielded, needing no shutter and leaving no period of darkness, having a film in constant motion yet practically stationary, may conceivably be the groundwork upon which a perfect, though somewhat expensive, instrument may be built. But why prophesy? Facts in the past remain facts in the present, but the future may be left to fate. If a long course of actuality has had a somewhat sedative effect, if fiction is needed to restore a somewhat wearied brain, let us leave prophecy, which is so easily falsified by the reality of the future, severely on one side, and glance at a living picture of the weirdest type. In Flammarion's "*Lumen*," as also in a little work introduced to English readers by the late R. A. Proctor, the idea of persistence of light rather than persistence of vision is elaborated. Light and other vibrations to which our limited perceptions afford no clue travel from this earth into space at a

definite velocity. So a continual record of the earth's history in its slightest details is continually streaming off into the eternal void, and, granted an eye capable of perceiving an object under a minute angle, infinitely sensible also to vibrations, it will be seen that at some point or other in space everything that has happened is yet visible. Grant this eye, or rather sense of vision, a capability of infinite speed of translation, it might retreat at the same speed as light and so keep the same event for ever in view, it might approach the outward travelling events and compress a lifetime into a moment. The whole history, not of this world alone, but of every sphere that is or has been, is still in vibrating existence, and one universal perception extending through the infinity would embrace within the tremblings of the boundless ether a consciousness of all that was or is, an eternal and universal living picture of all past events. Having started from persistence of vision due to the sluggish action of our mundane eyes or nerves, having lost ourselves in fancied possibilities of the illimitable, what remains for human thought and pen but the simple word

FINIS ?



## APPENDIX I.

### CHRONOLOGICAL DIGEST OF BRITISH PATENTS.

NOTE.—Reference is made to all specifications of interest in connection with the subject of Living Pictures, dated up to and including December, 1897, together with such further specifications dated 1898 as were published up to 31st December, 1898. Considerations of space confine the notices to bare mention of the main features of the respective Patents.

1. TALBOT, W. H. FOX-. No. 13,664. 12 June, 1851.  
Making instantaneous pictures of moving objects by "the instantaneous light of an electric battery . . . the rapidity of the motion not affecting the accuracy of the delineation." [Subsequently disclaimed.]
2. CLAUDET, A. F. J. No. 711. 23 March, 1853.  
Series of views are seen through stereoscopic eyepieces, which are alternately eclipsed by a reciprocating slide. Pictures mounted radially on two axes.
3. JUNDZILL, A. D. No. 1,245. 24 May, 1856. Two revolving discs like the "Phanakistoscope" or "Sobroscope" [? Stroboscope] are combined by stereoscopic eyepieces, being viewed in a mirror and periodically occluded by a revolving slotted disc. The apparatus is called the "Kinimoscope."
4. BENOIST, P. No. 1,965. 23 August, 1856. Two stereoscopic views exhibiting different phases of a motion are placed at right angles, a "grooved glass" [? transparent mirror] making an equal angle between them. By slight reciprocating action of this glass the two pictures are alternately viewed, thus giving the effect of the "Fenakistoscope." [Specification very vague.]
5. FISHER, R., and ASPRAY, C. No. 2,258. 5 October, 1859. The two sides of a stereoscopic slide are

- views of the same object in different positions. Illusion of motion is produced by alternately eclipsing each eyepiece.
6. DESVIGNES, P. H. No. 537. 27 February, 1860. Zoëtrophe and modifications. See pages 23 to 25, 44, 51.
  7. SHAW, W. T. No. 1,260. 22 May, 1860. An apparatus "on the principle of the reflecting stereoscope" [Wheatstone's] has (beside the synchronously revolving picture discs) revolving eye-discs which limit the time during which the picture is seen. In a refracting [ordinary form] instrument a revolving octagonal drum carries the pictures, and a revolving slotted drum limits the time of vision as well as confining the sight of each eye to the view intended for it.
  8. DU MONT, H. No. 1,457. 8 June, 1861. Reproducing successive phases of a motion. See page 45.
  9. BONELLI, G., and COOK, H. No. 2,063. 19 August, 1863. Series of small views are mounted on the edge of a disc and viewed through microscope, the disc being rotated in unison with perforated eyepiece.
  10. BONELLI, G. No. 1,588. 12 June, 1865. Much the same as preceding. Complete states that separate lens is necessary for each picture. [That is to say, this is a microscopic double-disc phenakistoscope with a lens inserted in each slot.]
  11. BRADLEY, M. No. 629. 6 March, 1867. Zoëtrophe of modern form with slots *above* designs.
  12. EDWARDS, E. No. 849. 23 March, 1867. Successive small pictures taken instantaneously on same plate. [Vague Chrono-photography.]
  13. ROSE, W. W. No. 3,156. 8 November, 1867. Zoëtrophe. Spindle runs down into stand.
  14. HARTLEY, F. W. No. 46. 7 January, 1868. Suggestion for application "by means of the 'phenakistoscope'" of varying pictures in series instead of ordinary lantern slides. [No apparatus described.]
  15. LINNETT, J. B. No. 925. 18 March, 1868. Book-form. See page 35. Leaves may be printed

- both sides, giving two series. Called "Kineograph" on drawings.
16. MAURICE, J. No. 1,049. 27 March, 1868. Combined use of transparent mirror and "phanakistiscope," "sobroscope," etc. The series of images may be drawn on endless bands. [Very vague.]
  17. LANGLOIS AND CO. No. 1,443. 2 May, 1868. Kinéscope. See page 33. Other forms described.
  18. ROSS, T. No. 681. 6 March, 1869. Magic lantern slides. Two discs are employed revolving in opposite directions; one transparent bearing figures, the other opaque with slots. [Very vague.]
  19. TREVOR, D. No. 2,193. 20 July, 1869. Radial series of pictures taken on revolving sensitised disc.
  20. ROSS, T. No. 2,685. 10 October, 1871. Lantern Wheel of Life. See page 19.
  21. RAY, A. No. 100. 8 January, 1874. A stereoscopic slide has its two views differing, they being taken at opposed phases of any motion. The views are rapidly and alternately eclipsed, so that while the first phase persists in one eye the second phase is revealed to the other, or the views are alternately hidden from sight by the action of a pendulum or oscillating beam. It is also suggested to print one design in red and the other in green, and view them through rapidly reciprocated screens of the same colours.
  22. DONISTHORPE, W. No. 4,344. 9 November, 1876. A series of pictures is taken on a set of plates, each of which is dropped from an upper chamber into a lower after exposure. The shutter is geared to cover lens during plate-changing. Prints from these negatives may be mounted in series and viewed in the zoëtrope, etc., or placed on a band arranged to be reeled off one roller on to another, any suitable device being used to obtain momentary views of the successive pictures. This apparatus was subsequently called the "Kinesigraph."

23. REYNAUD, C. E. No. 4,244. 13 November, 1877.  
Praxinoscope and Praxinoscope Theatre. See pages 26-29. A fixed screen may be placed so as to leave only one image visible at a time.
24. MUYBRIDGE, E. No. 2,746. 9 July, 1878. Instantaneous photography. Arrangement as described on page 49. [Name is mis-spelled "Maybridge" in Patent.]
25. EDWARDS, B. J. No. 10,226. 16 July, 1884. Lantern-slide changer worked by one-toothed cam and having shutter.
26. HUGHES, W. C. No. 13,372. 9 October, 1884. Choreutoscope. See page 20.
27. MELVILLE, A. A. No. 14,917. 17 November, 1886. Book-form. Called "Living Picture Book" on drawings. Several sets of designs may be bound radially.
28. LE PRINCE, L. A. A. No. 423. 10 January, 1888. Battery camera and projector. See page 52. A single-lens form with sprocket-actuated perforated film is suggested.
29. POTTER, E. T. No. 14,171. 2 October, 1888. Continuous lantern slides drawn from upper to lower spool by clockwork intermittent gear.
30. ADAMS, W. P. No. 16,785. 19 November, 1888. Continuous lantern slides. See page 64.
31. REYNAUD, C. E. No. 2,295. 8 February, 1889. Band-form Praxinoscope. See pages 29-30.
32. GREENE, W. F., and EVANS, M. No. 10,131. 21 June, 1889. Taking series of instantaneous photographs. See page 65. The shutter consists of two oscillating blades.
33. DONISTHORPE, W., and CROFTS, W. C. No. 12,921. 15 August, 1889. Cameras and projection apparatus. See page 67.
34. BRENNAN, L. No. 2,623. 18 February, 1890. Animated pictures. A long strip of paper, etc., is carried in zig-zag manner between two frames of rods standing at a distance from each other. It will be seen that (the outside of the rods being covered by portions of the paper strip) the front of either frame will present a plain surface which is made up of widely separated portions of the



long strip brought into contact by the method of winding in and out the two frames of rods. A picture may then be painted or a photograph transferred to this whole surface. If the end of the paper strip be pulled slightly the whole strip will move, and therefore all the separate painted portions will pass behind the rods, which are again covered by the following portions of white paper, thus forming a new white surface ready to receive a painting of the next stage of the action it is desired to represent. This operation is repeated to any desired extent. It will now be seen that if this strip (composed of minute sections) is rapidly drawn through the grille of rods the succeeding pictures will rapidly replace each other, the change taking place simultaneously over the whole extent of the picture. Mechanical arrangements for securing precision are described.

35. EVANS, M. No. 3,730. 8 March, 1890. Camera as on page 69. A brake may also be periodically applied to the driving-roller, or a frictional gear disconnected.
36. VARLEY, F. H. No. 4,704. 26 March, 1890. Apparatus as on page 70. The spools are spring-driven and provided with ratchets to prevent back-motion. Revolving disc shutter.
37. PHILLIPS, E. P., and COURTEEN, H. No. 4,978. 31 March, 1890. Advertising Zoëtrope rotated by hot air from lamp.
38. DEMENEY, G. No. 15,709. 1 September, 1892. Phonoscope. See pages 61-62.
39. BICKLE, T. E. No. 20,281. 10 November, 1892. Toy somewhat like the Pedemascope (page 33), but spring-actuated, the periodic rests being given by pendulum escapement. More than two surfaces may be used.
40. ELECTRICAL WONDER CO. (O. ANSCHUTZ). No. 23,042. 14 December, 1892. Electrical Tachyscope and Electric Wonder. See page 50.
41. HAWKINS, W. J. No. 7,609. 14 April, 1893. Advertising. Series of lantern pictures on drum rotated by escapement. The drum is free to

- turn every time clockwork lifts a pin from a slot in the drum-edge.
42. DEMENEY, G. No. 12,794. 30 June, 1893. Methods of mounting views in apparatus above (38). Stereoscopic device described.
  43. CHASSERAUX, E. No. 16,785. 6 September, 1893. Advertising. Set of transparencies on disc rotated by clockwork. An escapement pawl is periodically lifted by the inclined teeth of a ratchet-wheel.
  44. GREENE, W. F. No. 22,954. 29 November, 1893. Apparatus shown on page 84.
  45. DAVY, C. H. No. 24,031. 14 December, 1893. Combined musical-box and zoëtrope.
  46. DEMENEY, G. No. 24,457. 19 December, 1893. Chronophotographe. See pages 83-84.
  47. COLLINGS, J. H. No. 6,780. 5 April, 1894. Advertising. Transparencies on disc are intermittently rotated by electrically actuated pawl and ratchet-gear.
  48. MACKUSICK, E. F. No. 6,866. 6 April, 1894. Machine for continuous development, etc., of long films. [Quoted as typical. There are many others.]
  49. ANDERTON, J., and LOMAX, A. No. 25,100. 27 December, 1894. Kinetoscopes. Prisms are used to divert rays in order to afford separate points of view for several observers.
  50. WRAY, C. No. 182. 3 January, 1895. Prisms are used to enable the objective of projection apparatus to be placed at right angles to lantern-body and screen.
  51. LUMIERE, A. AND L. No. 7,187. 8 April, 1895. Cinématograph. See pages 95 and 201. For projection a translucent shutter is used.
  52. HOUGH, J. E. No. 9,881. 18 May, 1895. Drum-form apparatus. See Fig. 98.
  53. ACRES, B. No. 10,474. 27 May, 1895. Kinetic Lantern. See Fig. 97.
  54. EUROPEAN BLAIR CAMERA CO. and BLAIR, T. H. No. 12,458. 27 June, 1895. Camera, etc., as in Figs. 99 to 102.

55. CASLER, H. No. 14,439. 30 July, 1895. Mutoscope. See Fig. 41.
56. GREENE, W. F. No. 17,930. 25 September, 1895. Serial Camera. See Fig. 110. The apparatus may be used for projection.
57. FARNUM, W. C. No. 18,317. 1 October, 1895. A vertical shaft carries a radiating set of picture-cards, jointed to it by springs. As the shaft revolves a card is held back so as to be fully seen, and then released so as to fly round quickly and expose the next picture of the series. Apparatus called the "Tropograph."
58. JOLY, H. No. 18,695. 5 October, 1895. Date claimed, 26 August, 1895. Apparatus as in Figs. 108 and 109. A rotary disc, pierced near its periphery, is used as a shutter.
59. FARNUM, W. C. No. 19,331. 15 October, 1895. Viviscope. See page 41.
60. ARMAT, T. No. 359. 6 January, 1896. Apparatus designed to effect the change from one picture to another so rapidly that a shutter is dispensed with. Intermittent gear as Fig. 117, or dog-motion. Adjustable spring "gate." Disc-form also described. [Drawings have great resemblance to "Edison Vitascope" as shown in "Scientific American."]
61. SHORT, H. W. No. 3,777. 19 February, 1896. Sprocket-roller intermittently actuated by worm-gearing, part of the worm being cut away.
62. PAUL, R. W. No. 4,686. 2 March, 1896. Motion as in Fig. 120. The upper sprocket-wheel may have a spring connection with its axle so that it may give slightly to compensate slight irregularities in perforation. By adding an extra sprocket the machine may be made reversible, and marginal pressure-pads are used in the "gate." Segmental cylinder shutter used. See page 176.
63. LATHAM, W. No. 4,841. 3 March, 1896. Projection apparatus with parts which slide and clamp as on an optical bench. Conical bellows body limits light to area of picture. Film travels continuously, but as each picture is accurately

- centred an aperture in revolving disc allows light to pass, the shutter being so placed as to act on the most condensed portion of the beam.
64. SYMONS, W. No. 5,759. 14 March, 1896. Producing illusion of motion in the manner described under "Motograph" moving picture book, page 153.
  65. DE BEDTS, G. W. No. 6,503. 24 March, 1896. Date claimed, 14 January, 1896. Motion as in Fig. 116. See also page 184.
  66. RIGG, J. H., and KUMBERG, E. O. No. 6,731. 27 March, 1896. Motion as in Fig. 123. See also page 150.
  67. COLLINGS, J. H. No. 6,732. 27 March, 1896. Improvements on (47) above.
  68. LUMIERE, A. and L. No. 7,801. 13 April, 1896. Improved Cinématographe, Fig. 95. Shutter as in Fig. 226.
  69. SANSON, G. R. No. 7,809. 13 April, 1896. See the Cinécosmorama, page 162.
  70. OULTON, J., SHAW, W., and ADAMS, R. H. No. 7,817. 14 April, 1896. Motion as Fig. 121. Other arrangements also shown, such as friction-rollers engaging pins, etc. Shutter actuated by cam and lever, being returned by a spring. Film may be perforated transversely.
  71. BONN, J. No. 8,418. 21 April, 1896. Intermittent motion practically the same as Fig. 113.
  72. PARNALAND, A. F. No. 10,006. 11 May, 1896. Spring roller and escapement. A transverse axis operates the shutter by means of a cam and connecting-rod. Attached to the same axis is an escapement mechanism consisting of two cam-actuated plungers acting on a double ratchet-wheel. One plunger serves as escapement, the other as a stop, and this action is alternate. Systems of film-perforation are described.
  73. PETIT, A. N. No. 10,778. 19 May, 1896. Motion as in Fig. 105. Inspection apparatus as Figs. III and II2.
  74. MASKELYNE, J. N. No. 11,639. 28 May, 1896. See the Mutagraph, page 146.



75. TERME, J., and MAROUSSEM, A. DE. No. 11,836. 30 May, 1896. A frictionally driven sprocket-roller bears stops which come in contact with a spring-lever. A cam on the driving-shaft presses the lever back at intervals, thus releasing the sprocket-roller. Rotary segmental shutter.
76. REICH, T. No. 12,128. 3 June, 1896. Two motions described. One ratchet and pawl somewhat similar to Fig. 130. In the other form a rising and falling frame has a cam-surface which at stated intervals presses a claw-lever against or away from the film.
77. BLAIR, T. H. No. 13,284. 16 June, 1896. A long shutter slides vertically, and is provided with a roller on its top-edge. Towards the end of its upward stroke, when an opaque portion covers the lens aperture, this roller strikes the film and draws it onward one picture-length. The loop thus formed is taken up by the receiving-spool, the film meanwhile remaining stationary. To prevent exposure on the return stroke of the shutter, the aperture is provided with a cover-plate, which is only lifted when the shutter moves in one direction.
78. PARNALAND, A. F. No. 13,642. 20 June, 1896. Spring-tooth. See Fig. 179.
79. RICHARDS, G. No. 14,455. 30 June, 1896. The film is driven by two sprocket-wheels, one before and one after the lens opening. These two sprocket-wheels are rotated by a cogged wheel, which is itself intermittently actuated by a drunken screw. The take-up spool is frictionally driven to allow of slipping, and a form of spool with loose sides is described.
80. HEINZE, H. J. No. 15,603. 14 July, 1896. Motion as Fig. 129. A cam-actuated grip steadies the film during upward stroke of rollers. Shutter perforated or made of wire-gauze. In the latter case, two thicknesses may shift over one another in order to vary the amount of light passing. Special spool-box as Fig. 240.
81. ROUTLEDGE, W., ROSENBERG, A., and McDONALD, W. No. 16,080. 21 July, 1896. Motion as in Fig. 124. See also page 143.

82. HARRISON, G. H. and T. J. No. 17,049. 1 August, 1896. Motion as in Fig. 122 is applied to a wheel which drives upper and lower sprocket-wheels, between which the film is stretched.
83. GREENE, W. F., and PRESTWICH, J. A. No. 17,224. 4 August, 1896. Motion as in Fig. 127. See also page 168. Double projection positives are printed from ordinary negatives by running through first with double spacing and then running a second time to fill the alternate spaces. Adjustment by turning the dead-wheel of the epicyclic motion by hand. Duplicate form described.
84. BLAIR, T. H. No. 17,505. 7 August, 1896. The film is driven by two sprockets, one feed, one take-up, both continuous. Between these the film is sufficiently slack to allow an intermittent feed to be given by an arm rocked from an eccentric. Another eccentric forces pins into the perforations to steady the film during exposure. These pins have taper points which act to finally adjust the film.
85. PESCHEK, J., CHARD, G. H., and ACKERMANN, H. No. 17,848. 12 August, 1896. The intermittent motion of the film is effected by a lever connected to a plate carrying pins, or a rubber pad which presses on the film. The lever has a side-motion which drives a wedge into another wedge-piece on the plate, thus forcing it against the film, the vertical movement of the lever drawing the film down by means of the pins or pad. A return sideways movement releases the wedge-action, and the plate is forced back free of the film by a spring, and is carried up by the lever ready for another stroke. Either a rotary or hinged shutter is employed, the latter being a frame covered with tissue paper, etc.
86. WRENCH, A. No. 17,881. 12 August, 1896. Motion as in Fig. 131. See also page 165.
87. SCHMIDT, C. W., and CHRISTOPHE, A. No. 18,884. 26 August, 1896. Instead of using flexible film, a series of glass plates is fed to the lens from an upper chamber and passed into a lower one.

- after exposure. Each plate may receive several impressions, and is contained in a special metal carrier. Several devices are shown for effecting the necessary step-by-step motion.
88. WRAY, C. No. 19,181. 31 August, 1896. A compact apparatus capable of insertion in an ordinary lantern stage. Motion as Fig. 141.
  89. KORSTEN, L., MELIES, G., and REULOS, L. No. 19,446. 2 September, 1896. Kinétograph. See page 158.
  90. GRUNOW, W. No. 19,726. 7 September, 1896. Continuous development. Long band driven by rollers through various baths and drying-chamber. [Quoted as example only.]
  91. MELVILLE, A. A. No. 20,136. 11 September, 1896. Book-form apparatus. A U-shaped clip is employed, one leg being longer than the other. The long leg is passed into a recess in one cover of the book, and there secured. The shorter leg is tipped with rubber, and retains the leaves in the bend of the U. When the book-cover is bent back the leaves escape in a regular manner.
  92. JOLY, M. J. H. No. 21,381. 26 September, 1896. Date claimed, 17 March, 1896. Motion as in Fig. 128. See also Figs. 158 and 159.
  93. JOLY, M. J. H. No. 21,382. 26 September, 1896. Date claimed 23 July, 1896. See the Joly-Normandin Cinématographe, Fig. 157.
  94. JOLY, M. J. H. No. 21,383. 26 September, 1896. Printing positives. See Fig. 222.
  95. HEINZE, H. J. No. 22,627. 12 October, 1896. Motion as Fig. 142. Means for varying the feed and "preliminary enlarging lenses" are described.
  96. NEWMAN, A. S., and NEWMAN AND GUARDIA, LIMITED. No. 22,707. 13 October, 1896. Motion as in Fig. 140. The film is also fed continuously into a funnel-shaped passage, and there assumes a wavy form, which assists the feed by acting as a spring. The pins fitting the perforations are flexibly mounted.
  97. GREENE, W. F. No. 22,928. 15 October, 1896. Motion as Fig. 144, or a roller on the end of a

- rotating arm may strike the film. The driving-sprockets are adjustable, and the whole front of the machine is hinged to facilitate placing the film. The film is secured to the winding-rollers by a clip which may slip under undue tension.
98. LUMIERE, A. and L. No. 23,183. 19 October, 1896. The "Kinora." See page 39.
  99. LA PIPE, A. No. 26,765. 25 November, 1896. Date claimed, 8 September, 1896. Motion as Fig. 132. See also Fig. 162.
  100. WERNER, E. and M. No. 27,585. 3 December, 1896. Head of claw guided by D-grooves. See Figs. 138 and 139.
  101. NAISH, J. W. L. No. 28,799. 16 December, 1896. See page 162. Shutter as shown in Fig. 230.
  102. GAUTIER, P. No. 212. 4 January, 1897. Sprocket-roller bears ratchet, which is advanced step by step by means of a pawl on a lever swung from an eccentric. Locking-pawl lifted by projection on same lever. May be driven by clockwork.
  103. HUGHES, W. C. No. 449. 7 January, 1897. Multiple-wick incandescent oil-lamp suitable for use with cinematographs.
  104. SMITH, J. H. No 886. 12 January, 1897. The whole of the mechanism is contained in a drum-shaped casing pierced with equally spaced openings, the whole drum acting as a multiple shutter. The film is paid out and stored in the usual way, and the feed is accomplished by a revolving eccentric which strikes the film. Two films may be used side by side, a double series of non-coincident openings being provided in the drum for the purpose of obtaining a series of pictures overlapping in point of time. The apparatus may be used for printing and also projecting, in which case the projecting lens is placed in the interior of the apparatus.
  105. OBELT, T. VAN H. No. 1,039. 14 January, 1897. Motion as Fig. 119. Inventor says other machines are called the "Cineamatascope," "Cinimatograph," etc., but he proposes to call his the "Vitascope."
  106. OBELT, T. VAN H. No. 1,216. 16 January, 1897. A "claw" actuated by a cam is used to move



the film intermittently; but instead of being inserted, as usual, from the back, the prongs are passed through a front plate below the lens, and engage with the film perforations when the film is held forward by a spring plate, to which the film is held down by rollers. At such times as the film is required to be at rest this spring plate is forced back by a cam or electro-magnetic action, thus drawing the film away from the claw. Several modifications described. Shutter as Fig. 228.

107. COPP, C. P. No. 2,204. 27 January, 1897. Very vague description of apparatus "on the principle of the Wheel of Life."
108. RATEAU, A. No. 5,026. 24 February, 1897. Motion as in Fig. 134. Special driving and tension devices.
109. KOOPMAN, E. B. No. 5,995. 6 March, 1897. In this machine all parts are in continuous motion except the film itself. The film passes over a feed-drum and is drawn down at a regular rate by two friction-rollers below the exposure-aperture, these rollers rotating at a surface speed twice as great as that of the feed-drum. The film is normally clipped by a spring-clamp above the exposure-aperture, and when this is the case the friction-rollers merely slip over the surface of the film, but when the clamp is taken off by a revolving pin the friction of the rollers rapidly draws the film down, the slack which had accumulated behind the clamp coming forward ready for the next exposure. Unperforated films are used, but a punch makes two holes, one each side of each picture while in position, thus providing a means of absolute registration in the subsequent preparation of the picture.
110. PARNALAND, A. F. No. 6,202. 9 March, 1897. Improvements on (78) above. Spring steadying-frame for film and methods of reciprocating the claw-frame.
111. BERNSTEIN, F. No. 6,536. 12 March, 1897. Motion very similar to Fig. 118, but disc bears two pegs and two raised curves for steadying. Shutter as Fig. 231.

112. DUNCAN, J. H. H., and REICH, T. No. 7,635. 24 March, 1897. Motion as Fig. 130. Cam-actuated punch perforates strip at time of exposure, and may be thrown out of action when apparatus is used for projection.
113. O'NEILL, J., and MCNALLY, R. No. 8,572. 3 April, 1897. Ordinary book-form apparatus.
114. ACRES, B. No. 10,603. 28 April, 1897. Alternate apparatus. See Figs. 176 and 177.
115. BAXTER, C. W., WRAY, C., and OULTON, J. No. 11,273. 6 May, 1897. Double spring-pawl as Fig. 135. Frame reciprocated by snail-cam and drawn down by spring.
116. HEPWORTH, C. M. No. 11,923. 13 May, 1897. Automatic exhibiting apparatus. See Fig. 241.
117. GRAYSON, C. No. 12,052. 15 May, 1897. Lens mounted in sliding box-frame, and inspection-opening glazed ruby to allow image to be focussed on the film itself.
118. CASLER, H. No. 12,175. 17 May, 1897. Date claimed, 27 March, 1897. See page 151.
119. CASLER, H. No. 12,391. 19 May, 1897. Mutoscopes. Improvements on (55) above. See Figs. 36, 39, 40, and 42. Other slight modifications described.
120. LATHAM, W. No. 12,785. 24 May, 1897. A pair of rollers feeds the film frictionally. One roller is rubber-coated and drives the other. Means are provided for varying the pressure between the rollers, and so altering the speed in order to compensate for irregularities in the film. Adjustable dog, see Fig. 143.
121. CAMPBELL, C. M. No. 12,911. 25 May, 1897. See page 152.
122. PORTER, T. C. No. 12,921. 25 May, 1897. Double projection apparatus for kinetographic and other purposes. Observers look through occluding eyepieces synchronised with the projection shutters.
123. CORTHESEY, J. H. No. 13,826. 5 June, 1897. Book-form and rotary-leaf apparatus. The leaves are bound or fastened at an angle to the binding or band in order that they may turn over more rapidly.

124. NOBLE, C. S., and LIDDELL, F. No. 14,861. 19 June, 1897. A reciprocating roller strikes the film in order to move it intermittently. To secure regular action this roller is mounted on arms swung from the same axis as the take-up sprocket, and its motions are so timed as to keep it in constant contact with the film. The spool axles are prolonged in order to allow one film to be rewound while another is being exhibited.
125. CASLER, H. No. 16,388. 10 July, 1897. Date claimed, 10 December, 1896. The Mutograph. See page 135.
126. DARLING, A., and WRENCH, A. No. 17,248. 21 July, 1897. Motion as Fig. 136. This one double-action cam raises, lowers, inserts, and withdraws the claw. A shutter composed of segments sliding over one another is also described. By these means the area of the shutter may be varied.
127. SANDOW, E. No. 17,565. 27 July, 1897. Claims taking one set of stereoscopic and another set of single views on same film, for kinetoscopes or other purposes.
128. BELLET, F. No. 17,747. 28 July, 1897. Means for throwing two cogged wheels in and out of gear with another central one by mounting them on a rocking plate. Said to be applicable to all apparatus in which a film or band is wound up in either direction.
129. RATEAU, A. No. 18,014. 31 July, 1897. Improvements on (108) above. See Fig. 171. In addition, means for governing speed are described such as varying the air-pressure in a cylinder the piston of which is connected to a rotating part; and a mirror may be interposed in the path of the light for the purpose of exhibiting titles, etc.
130. DRITTLER, B., and ERLANGER, M. No. 18,610. 11 August, 1897. Rotary apparatus. See Fig. 45.
131. JONES, W. J. H. No. 19,278. 20 August, 1897. The apparatus is called the "Excelograph."

The film is drawn down by the grip of two rubber-faced rollers. One of these rollers is periodically revolved by the stroke of a toothed quadrant gearing with cogs on the same axle as the roller. The latter is prevented from turning backward on the return of the quadrant by a ratchet. The quadrant is caused to make intermittent strokes by the action of a stud on a revolving disc, such action being direct or through intermediate levers.

132. NEVE, C. R. No. 19,805. 28 August, 1897. Alternate exposure or projection. Two films, running side by side, are alternately moved by tappet-levers. One shutter serves the two lenses.
133. KRONKE, E. No. 20,936. 11 September, 1897. Hand-camera. One pressure on a lever makes exposure and changes plate, or rotates film-spool. Said to be suitable for producing series of pictures for use in kinetoscopes.
134. MORRISON, H. No. 21,408. 18 September, 1897. Kinematograph. [Not yet accepted. Title included to complete the year 1897.]
135. ELKAN, A., and STERNBERG, J. No. 22,558. 1 October, 1897. A variable groove on the edge of a rotating disc engages with pins projecting from the end of the sprocket-wheel. Methods of adjusting film, etc., are described.
136. LANGHAM, A. B. No. 22,763. 5 October, 1897. Mutoscopic coin-freed apparatus having views mounted in special metal clips and passing over a pulley the diameter of which is four times as great as the distance between successive views, which thus stand separated for inspection by a space of 90 degrees.
137. LAMBERT, J. No. 23,231. 9 October, 1897. Toy disc bearing ornamental or other designs, and working on ordinary phenakistoscopic principles.
138. SCHWARZ, A. No. 23,897. 16 October, 1897. Developing, etc. Means for feeding exposed photographic strips through a number of adjacent baths by fixing such strips to travelling bands moving horizontally in a serpentine or zig-zag manner. [Quoted as sample only.]



139. EDWARDS, R. H. No. 24,273. 20 October, 1897.  
The continuously moving film is led over two rollers, the reciprocating motion of which periodically neutralises the proper motion of the film. This reciprocation may be vertical or horizontal, and several arrangements are shown.
140. HYMMEN, O. No. 24,804. 26 October, 1897.  
Claims making double series of views on cinematograph bands, etc., for stereoscopic purposes. Also, in book-form apparatus the two views are placed one on the right and one on the left of each opening of the book.
141. MOY, E. F., and HARRISON, G. H. No. 25,625.  
4 November, 1897. Motion as Fig. 137.
142. GRIVOLAS, C. No. 27,038. 18 November, 1897.  
Date claimed, 20 April, 1897. Motion as Fig. 133. Modifications are described. Among others, cams may be fitted to cause the two rollers (mounted on arms) to have an opening and shutting jaw-movement in order to grip the film periodically.
143. WIGHT, N. No 27,375. 22 November, 1897. A reel apparatus in enclosed case applicable for the development of cartridge films, and also for the subsequent fixing and washing. [Quoted as example. Not directly stated as applicable to cinematograph films.]
144. NELSON, N. No. 27,505. 23 November, 1897.  
Spiral camera and lantern. See page 153.
145. NEWMAN, A. S., and NEWMAN AND GUARDIA, LIMITED. No. 27,542. 23 November, 1897.  
Improvements on (96) above. See page 179.
146. MORRISON, J. A. No. 28,033. 29 November, 1897. Cam-release for series of transparencies adapted for projecting advertisements, etc.
147. GREENE, W. F. No. 29,363. 11 December, 1897.  
Exhibiting animated pictures on advertising, etc., devices carried on the person.
148. SUMMERS, A. No. 29,694. 15 December, 1897.  
Instantaneously changing slides for magic and other view projecting lanterns. [Still pending. Included to complete list for year 1897.]
149. MOON, H. H. No. 441. 6 January, 1898. Star-wheel driven by pawl-like action of the bevelled

- end of a lever, oscillated from a pin on a crank disc.
150. HUGHES, W. C. No. 681. 10 January, 1898. For main features of this patent see page 140. Shutter as Figs. 227 and 229.
151. MILLER, W. V., RICE, G. P., and DUNN, E. B. No. 5,485. 5 March, 1898. One cam acting on a lever inserts and withdraws a bolt to lock the sprocket-wheel, while another periodically shifts a rocking-shaft into engagement with the sprocket-wheel. Thus the sprocket-wheel is first locked, then a forward motion drives teeth into holes in its side, thus connecting it with the shaft. The bolt is then withdrawn, the shaft makes a turn and rotates the sprocket-wheel, which is again locked by the bolt. The shaft then withdraws from engagement with the sprocket-wheel, and rocks back to its previous position ready to recommence the cycle of movement above described.
152. KAMM, L. U. No. 6,515. 17 March, 1898. Cinematographic spiral cameras and projectors. The plate is intermittently rotated by a variable screw and traversed by a cog on the end of its axle rolling along a rack as the plate rotates. Special two-sector shutter described.
153. HUGHES, W. C. No. 6,724. 19 March, 1898. Photo-rotoscope Peep-show. See Fig. 242.
154. PARSONAGE, C. No. 8,286. 7 April, 1898. Endless band of metal carriers for lantern slides intermittently moved by clockwork.
155. TAYLOR, E. Z. No. 8,661. 13 April, 1898. Advertising device exhibiting series of screens hanging from drum rotated by intermittent gear, several forms of which are described.
156. NORDISK REKLAME KOMPAGNI. No. 9,374. 23 April, 1898. A film of views, advertisements, etc., is intermittently moved by gear such as Fig. 118. Safety condenser as Fig. 239.
157. CAMPBELL, C. M. No. 11,219. 17 May, 1898. Improvements on (121) above. Film is stored in loops instead of on spools; the mirror is buffered to prevent noise, and may be of concave, convex, or other form to produce distortion.

158. NOBLE, C. S., and NEWTON, H. C. No. 15,195.  
11 July, 1898. See the "English" Kinematograph, page 173.
159. NEWTON, H. C., and IVES, F. E. No. 18,346.  
26 August, 1898. Sliding-front for adapting kinematographs and other projection fittings to the same lantern body.

## ADDENDA.

NOTE.—Several specifications of interest having been accepted since the compilation of the above list, the further publications to the end of January, 1899, are added here, it being impossible to include them in correct chronological order. No. 134 above is now declared void.

160. WILSON, G. R. No. 3,477. 11 February, 1898.  
Stereoscopic cinematography by two cameras geared together or pair of views side by side on same film.
161. PACTH, L. V. No. 8,362. 7 April, 1898. Film is driven by grip of rollers which are held apart (and therefore do not act on the film) whenever a pair of pins are driven through the perforations to steady the film. This is effected by electromagnetic devices.
162. HUGHES, W. C. No. 17,805. 18 August, 1898.  
Improvements on (150) above.
163. SHORT, H. W. No. 23,158. 3 November, 1898.  
The Filoscope. See page 36.
164. AUGUST, J. S., and COHN, J. No. 23,327. 5 November, 1898. Frictional driving mechanism for kinematographs, etc.
165. BARRON, G. No. 24,735. 23 November, 1898.  
Coin-freed apparatus for inspection of continuously moving image by means of rocking mirror. Also for projection.

## APPENDIX II.

### ANNOTATED BIBLIOGRAPHY.

NOTE.—Roman figures indicate the number of the volume, Arabic figures the page. Figures in round brackets indicate a series. Author's notes, etc., are placed in square brackets. Only a limited number of articles are here noticed; reprints, translations and purely trade notices are excluded.

#### 1825

1. ROGET. Explanation of an optical deception in the appearance of the spokes of a wheel seen through vertical apertures. [Spokes appear curved,—anorthoscopic phenomena.] *Phil. Trans.* 131.

#### 1827

2. The Thaumatrope. [Editorial ? by Brewster, see page 5. Invention attributed to Dr. Paris.] *Edinb. Jl.* iv. 87.

#### 1828

3. PLATEAU. Sur les apparences que présentent deux lignes qui tournent autour d'un point avec un mouvement angulaire uniforme. [Wheel phenomena.] *Corresp. math. de Quetelet*, iv. 373.

#### 1829

4. LE FRANCOIS. Courbes d'intersection apparente de deux lignes qui tournent avec rapidité autour de deux points fixés. *Ibid.* v. 120, 379.
5. PLATEAU. Lettre relative à différentes expériences d'optique. [Wheel phenomena.] *Ibid.* vi. 121.

#### 1831

6. AIME. Phénomènes qui arrivent quand on met deux roues en mouvement l'une devant l'autre. *Bull. de Férussac*, xv. 103-107.



7. FARADAY. On a peculiar class of optical deceptions. [Wheel phenomena ; very interesting paper.] *Jl. R. Inst. [N.S.]*, i. 205.
8. PLATEAU. Lettre sur une illusion d'optique. [Wheel phenomena.] *Ann. de chimie et de phys.* (2), *xlvi*. 281.

**1833**

9. PLATEAU. Sur un nouveau genre d'illusion d'optique. [Phenakistoscope.] *Corresp. Obs. de Bruxelles*, *vii*. 365.
10. PLATEAU. Des illusions sur lesquelles se fonde le petit appareil appelé récemment Phénakistoscope. [English name quoted as Fantoscope.] *Ann. de chimie et de phys.* (2), *liii*. 304.

**1834**

11. HORNER. On the properties of the Dædaleum, a new instrument of optical illusion. [See page 22. Paper also contains full discussion of theory of distortion caused by moving slots.] *Phil. Mag.* (3), *iv*. 36.
12. STAMPFER. Ueber die optischen Täuschungs-Phänomene welche durch die stroboskopischen Scheiben (optischen Zauberscheiben) hervorgebracht werden. [Description of Stroboscope ; suggestion of band.] *K.K. polytech. Institut, Wien. Jahrbücher*, *xviii*. 237.
13. Stroboskopische Scheiben, Phänakistiskop, Phantasmaskop. *Pogg. Annalen*, *xxxii*. 636.

**1835**

14. SNELL. Description of an instrument for exhibiting a certain optical deception. [Phenakistoscope and wheel distortions. Stroboscope called Phantoscope or Kaleidorama.] *Sill. Jl.* (1), *xxvii*. 310.

**1836**

15. PLATEAU. Notice sur l'anorthoscope. *Bull. Acad. Bruxelles* (1), *iii*. 7.

## 1846

16. MULLER. Anwendung der stroboskopischen Scheibe zur Versinnlichung der Grundgesetze der Wellen-Lehre. Pogg. Ann. lxxvii. 271.
17. PLATEAU. Sur de nouvelles applications curieuses de la persistance des impressions de la rétine. [Illusive motion from modified anorthoscope.] Bull. Acad. Bruxelles (1), xvi. pt. i. 424, 588; pt. ii. 30, 254.

## 1850

18. TYNDALL. Phenomena of water-jet. [Momentary illumination by electric spark.] Phil. Mag. (4), i. 105.

## 1852

19. MOIGNO. Stéréo-fantoscope ou Bioscope de M. J. Duboscq. [Combination of ordinary phenakistoscope with stereoscopic eyepieces.] Cosmos, i. 703.
20. PLATEAU. Sur le passage de Lucrèce où l'on a vu une description du fantoscope. Ibid. i. 307.

## 1853

21. POPPE. Das verbesserte Interferenzoscop [for exhibiting wave-motion.] Pogg. Ann. lxxxviii. 229.
22. ROLLMANN. Ueber eine neue Anwendung der stroboskopischen Scheiben. [Discussion of relation between number of slots and images.] Ibid. lxxxix. 246.
23. UCHATIUS. Apparat zur Darstellung beweglicher Bilder an der Wand. Wiener Akad. Sitz.-Ber. x. 482.

## 1858

24. ALMEIDA. Nouvel appareil stéréoscopique. [Alternate vision, projection or inspection, by eclipse or use of coloured screens.] Comptes rendus, xlvi. 61.

**1861**

25. SHAW. Description of a new optical instrument called the "Stereotrope." [Double cylinder zoëtrope working on its side.] *Phil. Mag.* (4), xxii. 537.

**1864**

26. BABBAGE. Passages from the life of a philosopher. [Thaumatrope invented by Herschel and Fitton.] London.

**1865**

27. CLAUDET. On moving photographic figures, illustrating some phenomena of vision connected with the combination of the stereoscope and phenakistoscope by means of photography. [Views on rotating drums, alternate vision.] *Brit. Assn. Rept.* 1865, pt. ii. 9.
28. LAING. Combination of Stereoscope and Phenakistoscope. [Called the Motoroscope.] *Mech. Mag.* (2), xiii. 190.

**1867**

29. CLAUDET. New fact relating to binocular vision. [Stereo-thaumatrope, see page 7.] *Phil. Mag.* (4), xxxiii. 549.
30. TOPLER and RADAU. Stroboscope ou Vibroscope universel [used to render the regular cyclic motion of a body slower in appearance by intermittent illumination]. *Les Mondes*, xv. 206.
31. WEBER. Theorie des Anorthoscops und der anorthoscopischen Figuren. *Zeit. Math. u. Physik.* xii. 133.

**1868**

32. CARPENTER. On the Zoëtrope and its antecedents. *Student*, i. 427; ii. 24.
33. CARPENTER. The Anorthoscope. *Ibid.* ii. 110.
34. JEFFRIES. Remarks upon the principles of the Thaumatrope. *Am. Opth. Soc. Trans.* 1869, 8.

35. LANGLOIS and ANGIERS. Kinéscope. [Alternation of two microscopic views.] *Les Mondes*, xvii. 56.

**1869**

36. MAXWELL. Zootrope perfectionée. [Concave lenses used instead of slots.] *Ibid.* xx. 585.

**1871**

37. ZIZMANN. Die Bilder der stroboskopischen Scheibe objectivirt. [Description vague. No light interrupter shown.] *Dingler's Jl.* cxcix. 231.

**1875**

38. FLAMMARION. Le Passage de Vénus. [Janssen's Révolver photographique.] *La Nature*, 1875, pt. i. 356.

**1876**

39. JANSSEN. Présentation du révolver photographique. *Bull. Soc. franç. Phot.* xxii. 100.

**1878**

40. DONISTHORPE. Talking photographs. [Apparatus called Kinesigraph (band illuminated by electric spark) combined with Phonograph.] *Nature*, xvii. 242.
41. TISSANDIER. Le Praxinoscope [de M. Reynaud]. *La Nature*, 1879, pt. i. 133.
42. TISSANDIER. Les Allures du Cheval. [Muybridge's early work.] *Ibid.* 23.

**1880**

43. TISSANDIER. Le Praxinoscope Théâtre [de M. Reynaud]. *Ibid.* pt. i. 147.

**1881**

44. LOMMEL. Einfaches Verfahren, die stroboskopischen Erscheinungen für Viele gleichzeitig



- sichtbar zu machen. [See page 15.] Carl's Rept. xvii. pt. 7, 463.
45. REYNAUD. La Toupie-fantoché. *La Nature*, 1882, pt. i. 73.

**1882**

46. MAREY. Le fusil photographique. *Ibid.* 1882, pt. i. 326.
47. MOLteni. Le Phénakistiscope de projection. [Lantern Wheel-of-Life.] *Ibid.* pt. 2, 64.
48. TISSANDIER. Le Praxinoscope de projection [de M. Reynaud]. *Ibid.* 357.

**1883**

49. MUYBRIDGE. The attitudes of animals in motion. [Account of apparatus and methods.] *Jl. Franklin Inst.* (3), lxxxv. 260.

**1888**

50. CARBUTT. A perfect substitute for glass . . . for use in photography. [History of flexible supports for photographic images.] *Ibid.* xcvi. 478.
51. MAREY. Photo-chronographie. [Slight description of first band-form apparatus.] *Comptes rendus*, cvii. 607, 643, 677.

**1889**

52. ANSCHUTZ. Electrical Tachyscope. *Sci. Am.* lxi. 303.
53. MUYBRIDGE. Lecture at the Royal Institution. [Account of Zoopraxiscope.] *B. Jl. Phot.* xxxvi. 826.

**1890**

54. LONDE. La Chronophotographie. [Good summary and description of Sébert's experiments.] *La Nature*, 1890, pt. i. 97, 151.
55. MAREY. La locomotion dans l'eau. [Illustration of first pellicular apparatus.] *Ibid.* pt. ii. 375.

56. Le Cinétographe d'Edison. [First notice. Illustration of film with one row of perforations.] *Cosmos* [N.S.], xix. 456.
57. Machine camera taking ten photographs a second. [First publication of Greene and Evans' apparatus.] *Phot. News*, xxxiv. 157.
58. Remarkable novelties in photographic instruments. [Greene's double projection apparatus made by Rudge.] *Ibid.* 421.

### 1891

59. EDISON. Kinetograph. *Engineering*, i. 678.
60. MAREY. Le Chronophotographie. [Good review of subject to date.] *Rev. gén. des Sciences*, ii. 689.

### 1892

61. DEMENY. Les photographies parlantes. [Kinonoscope.] *La Nature*, 1892, pt. i. 311.
62. TISSANDIER. Le Théâtre optique [de M. Reynaud. With long band.] *Ibid.* pt. ii. 127.
63. Mechanical Toys. [Various means of sectional change over whole surface.] *Optician*, iv. 82.
64. Novel application for Zoëtropes. [Deeply corrugated surfaces of rotating cards as a means for the synthesis of natural colour, by means of primaries seen at different angles.] *Ibid.* iv. 110.
65. Universal panoramic camera. [Kinetoscopy by continual revolution of ordinary panoramic camera.] *Ibid.* iii. 450.

### 1893

66. LONDE. La Photochronographie appliquée aux sciences médicales. [Electrically controlled apparatus.] *Bull. Soc. franç. Phot.* (2), ix. 572.
67. Panoramic photography. [Moving sensitive surface formed of portion of spiral rendered optically stationary by cyclostat.] *Optician*, v. 786.
68. Zoëtrope exposures. [Vibrating flames for intermittent lighting.] *Ibid.* v. 696.

## 1894

69. DICKSON. History of the Kinetograph, Kinetoscope, and Kineto-phonograph. London and New York.
70. EDISON. Kineto-phonograph. *Electrical World*, xxiii. 799.
71. EDISON. Kinétoscope. *La Nature*, 1894, pt. ii. 323.
72. JENKINS. Photochronographic camera. [Exterior view only.] *Phot. Times*, xxv. 2.
73. MARESCHAL. La chronophotographie d'amateur et le portrait vivant. [Demeny's Chronophotographe d'amateur or Biographe.] *La Nature*, 1894, pt. ii. 279.
74. MAREY. *Le Mouvement*. Paris.
75. THOMPSON. Life and works of T. A. Edison. [Review; states that machines similar to Kinetoscope (? Anschütz') were shown at Frankfort Electrical Exhibition, 1891.] *Electrician*, xxxiv. 187.
76. An application of Optics. [Optical means for intermittent kinoscopy.] *Optician*, vii. 164.
77. Are Lantern Stereotropes possible? [History of the Stereo-phenakistoscope.] *O.M. Lantern JI*. v. 23.

## 1895

78. IREX. The Lantern Stroboscope [for momentary illumination of moving objects]. *Ibid.* vi. 112.
79. LATHAM. The Eidoloscope. [Apparently on system of Reynaud's praxinoscope de projection, but no details given.] *Phot. Times*, xxvii. 173.
80. LUMIERE. Le Cinématographe. [Description and account of exhibition, 11th July, 1895.] *La Nature*, 1895, pt. ii. 215.
81. STORY. Who is the inventor of the Kinetoscope? [Greene claimed.] *B. JI. Phot.* xlii. 772.
82. WENHAM. The Kinetoscope. [Letter on experiments in 1852.] *Eng. Mech.* lxi. 352.
83. La Chronophotographie pratique. [Demeny's dog-motion.] *Inventions nouvelles*, viii. pt. ii. 390.

84. Photochronographic apparatus for amateurs. [Demeny's eccentric spool.] *Phot. Times*, xxvi. 39.
85. Projicirte Bewegungsbilder von Anschütz. [Exhibited November 15th, 1894; no description of details.] *Phot. Archiv.* xxxvi. 10.

## 1896

86. ACRES. Animated photography. [History and dates.] *Amateur Phot.* xxiv. 298.
87. DEMENY. Chronophotographe. [Final form.] *Vie Scien.* 1896, pt. ii. 267.
88. EAMES. The Animatoscope. *Phot. Times*, xxviii. 330.
89. GUEROULT. Sur un application nouvelle de la photographie et du phénakistoscope. Deposited 1889. [Photographs taken at long intervals rapidly combined or shown backwards. Instrument called photo-cinégraphe.] *Comptes rendus*, cxxii. 404.
90. JENKINS. Development of Chrono-photography. [Review; own apparatus; life-size coin-freed peep-show.] *Phot. Times*, xxviii. 449.
91. JENKINS. The Phantoscope. [First description of details.] *Ibid.* xxviii. 222.
92. JOLY. Kinétoscope à vues multiples. *La Nature*, 1896, pt. i. 337.
93. LOMAX. Kinetoscope and lantern. [Summary of position of Kinetograph.] *O.M. Lantern Jl.* vii. 132.
94. MARESCHAL. Chronophotographe construit par Demeny. [Projecting and reversing arrangement.] *La Nature*, 1896, pt. ii. 391.
95. POPLAWSKI. Neuer Apparat [von Poplawski und Lebedzinski]. *Phot. Mitth.* xxxii. 329.
96. VITOUX. Photographie du mouvement. Chrono-photographie. Kinétoscope. Cinématographe. Paris.
97. VOLKMER. Die Rotations-Photographie und der Kinematographe, oder "die lebende Photographie." [Lumière's apparatus and suggestions for applications; scenery, etc.] *Zeit. Oest. Ing. Vereins*, xlvi. 369, 377.



98. Continuous revolution Kinetoscopy. *Optician*, x. 341, 355, 360; xi. 41.
99. Le Folioscope. [Double-book form.] *La Nature*, 1896, pt. i. 256.
100. Kinetoscope stereopticon. [Jenkins' Phantoscope and Kinetoscopic Camera, also Edison's Vitascope.] *Sci. Am.* lxxv. 325.
101. Viviscope. *Ibid.* lxxiv. 395.

## 1897

102. ACRES. Letter on the invention of the Cinematograph. *Am. Phot.* xxvi. 277.
103. ACRES. Making and exhibiting living pictures. [Contains dates of his invention.] *Jl. Camera Club*, xi. 65.
104. BEDDING. Animated Photography [History of]. *B.J. Phot. Almanac*, 1898, 643.
105. BRUNEL. *La Photographie et la Projection du Mouvement*. Paris.
106. DONISTHORPE. Letter on the Kinesigraph [and his subsequent patents]. *Brit. Jl. Phot.* xlv. 175, 207.
107. FRITSCH. Reminiscenzen über . . . den Kinematographen. [Correspondence between Uchatius and Prokesch.] *C. Z. f. Optik*, u.s.w. xviii. 211.
108. GASTINE. *La Chronophotographie sur plaque fixe et sur pellicule mobile*. Paris.
109. GAUMONT. La Grille. [Perforated fan for viewing screen.] *Bull. Soc. franç. Phot.* (2), xiii. 295.
110. HANAU and MONTSERRET. Le développement des pellicules kinétographiques. *Vie scient.* 1897, pt. ii. 532.
111. HEPWORTH. The Cinematograph. [History.] *Am. Phot.* xxvi. 262.
112. JENKINS. Films [Development of]. *Phot. Times*, xxix. 127.
113. JENKINS. The picture-ribbons used in chronophotography. [Perforating, printing, developing.] *Ibid.* 259.
114. JENKINS. Improved Kinetoscopic camera and printing apparatus. *Sci. Am.* lxxvi. 281.

115. LUMIERE. Development and projection of kinematograph films. *Brit. Jl. Phot.* xliv. suppt. 91.
116. LUMIERE. Sur les dangers du cinématographe. [Safety condenser.] *Bull. Soc. franç. Phot.* (2), xiii. 361.
117. MARESCHAL. Les erreurs du cinématographe. Suppression du scintillement. *La Nature*, 1897, pt. i. 368.
118. MAREY. Nouvelles modifications du Chronophotographe. [Camera, projector, printing and developing apparatus.] *Bull. Soc. franç. Phot.* (2), xiii. 217.
119. RAE. Development of kinetograph films. *Phot. News*, xli. 265.
120. REYNER. Les origines de la photographie animée. [Réville's double-disc and stereoscopic apparatus, 1857.] *Vie scientifique*, 1897, pt. ii. 451.
121. ROBINS. Animated Pictures. *O.M. Lantern Jl.* viii. 99.
122. ROBINS. Hints on exhibiting Cinematographs. *Ibid.* 129.
123. ROBINS. Development of Kinetograph films. *Ibid.* 102.
124. ST. CLAIR. The Watkins Micromotoscope. *Sc. Am.* lxxvii. 75.
125. WARD. Kinetography.—The production of living pictures. *Knowledge*, xx. 216.
126. WRENCH. The Cinematograph for attaching to the lantern. [History; own apparatus; discussion.] *Jl. Camera Club*, xi. 36.
127. Animated photographs and projecting machines. *O.M. Lantern Jl.* viii. 103.
128. Biograph and Mutograph. *Sci. Am.* lxxvi. 248.
129. Chronophotographie. [Review and description of modern machines.] *Rev. scient. et industr.* 1897, i. 179.
130. Cinématographe de 19 sous. [Revival of Kinéscope, see page 33.] *La Nature*, 1897, pt. i. 110.
131. Folioscope mécanique. [Radial form.] *Ibid.* 1897, pt. i. suppt. 23.
132. New Kinematograph. [Continuous rotary action.] *Optician*, xiii. 212.

## 1898

133. BELLINGHAM and HOLT. Glycerine a heat absorbent in lantern projection. *Brit. J. Phot.* xlv. suppt. 28.
134. EDER and VALENTA. Ueber die Fortschritte der Photographie (Serienapparate). *Dingler's J.* cccviii. 90.
135. HEPWORTH. *Animated Photography: the A B C of the Cinematograph.* [Practical operator's handbook.] London.
136. HEYL. Contribution to the history of the art of photographing living subjects in motion and reproducing the natural movements by the lantern. *Jl. Franklin Inst.* (3), cxv. 310.
137. HUGHES. A little information about the Cinematograph. [Discussion of principles.] *O.M. Lantern Jl.* ix. 9, 24, 44.
138. JENKINS. *Animated Pictures.* *Phot. Times.* xxx. 289.
139. JENKINS. Patentable priority in chronographic apparatus. *Ibid.* 152.
140. JENKINS. The Perforations [of Kineto-films]. *Ibid.* 113.
141. *Le Cinématographe appliqué à l'astronomie.* [Flammarion's terrestrial globe.] *Vie scientifique*, 1898, pt. i. 160.
142. *Le Cinématographe pour tous.* [Monnard's invention; minute photos. in spiral on disc; invented word used, the télécinématographe.] *La Nature*, 1898, pt. i. 90.
143. *Neue Formen des Kinematographen und verwandter Apparate.* *Eder's Jahrbuch*, 1898, 188.
144. Viewing film transparencies in the Cinematograph without projection. *O.M. Lantern Jl.* ix. 3.
145. LONDE. *L'Aléthorama* [de MM. Mortier et Chéri-Rousseau]. *La Nature*, 1898, pt. ii. 253.

# GENERAL INDEX.

NOTE.—Numbers refer to pages, except those preceded by the letters P. and B., which refer to the items in the Patent Appendix and Bibliography respectively. Roman figures refer to the Commercial Appendix. Names of persons are printed in SMALL CAPITALS; names of apparatus in *italics*; subject entries are in ordinary Roman type. In some instances the early references only have been indexed; *etc.* being added to show that the subject-matter becomes general throughout subsequent pages. In order to assist extended reference, minor details of Patents and Bibliographical Articles have been indexed here, though omitted from the text.

- ACKERMANN, P. 85  
ACRES, 97, 158, 174, 198. P. 53, 114.  
B. 86, 102, 103  
ADAMS, 64. P. 30, 70  
Adjusting films and views, 23, 131,  
139, 141, 148, 160, 173, 176, 212.  
P. 6, 23, 32, 50, 72, 74, 79, 80, 81,  
83, 86, 97, 101, 116, 126, 131, 135,  
149, 151, 158, 162  
*Ærial Graphoscope*, 185  
AIMÉ, 10. B. 6  
AIRS, 176  
*Aléthorama*, 171. B. 145  
ALHAZEN, 4  
ALIBERT, 167. B. 129  
ALMEIDA, B. 24  
Alternate projection or inspection, 32,  
41, 57, 66, 89, 92, 107, 158, 168, 202.  
P. 4, 17, 39, 44, 83, 104, 114, 132.  
B. 24, 35, 58, 88  
Alternate vision (one eye at a time),  
40. P. 2, 5, 21, 122. B. 24, 27  
*Amateur-Kinematador*, 175  
*Amateur-Kinetograph*, 157  
*Anarithmoscope*, 187  
ANDERTON, 220. P. 49  
ANGIERS, 33. B. 35  
ANGLO-AMERICAN IMPORT CO., 185  
ANGLO-CONTINENTAL CO., 166  
*Animatographe*, 176. P. 62  
*Animatoscope*, 92, 175. B. 88  
*Anorthoscope*, 9, 16. B. 1, 15, 17, 31,  
ANSCHÜTZ, 24, 25, 49, 74, 79. P. 40.  
B. 52, 75, 85  
ANTHONY AND CO., 152, 154  
Aphengoscopic projection. *See* Projec-  
tion, *etc.*  
*Apollo Kinetograph*, 158, 207  
APPLETON, 185, xx., xxi.  
Applied to—  
advertising, 162, 222. P. 37, 57,  
116, 147  
astronomical purposes, 57, 231. B.  
38, 39, 141  
historical record, 230  
jewellery, 33. B. 35  
mechanical investigation, 54, 152,  
232  
medical research, 54. B. 66  
portraiture, 148, 231  
reproducing speech, 61. P. 38, 46.  
B. 40, 61  
scientific demonstration, 14, 26, 231.  
P. 69. B. 16, 21, 30, 42, 46, 49,  
55, 124  
stage scenery, 84, 162. P. 44, 69.  
B. 97  
ARCY, 4  
ARMAT, P. 60  
*Artograph*, 187  
ASPRAY, P. 5  
AUGUST, P. 164  
Automatic apparatus, 39 51, 222. P.  
40, 98, 116, 136, 165. B. 90



- BABBAGE, G. B. 26  
*Badizograph*, 187  
 BAMFORTH, xviii.  
 BARRON, P. 165  
 Battery form, 49, 51, 54. P. 24, 28.  
   B. 42, 49, 54, 66  
 BAXTER, 184. P. 115  
 BEALE, 19, 20  
 BEARD, 185  
 BEDDING, B. 104  
 BELLET, P. 128  
 BELLINGHAM, B. 133  
 BENOIST, P. 4  
 BERNSTEIN, P. 111  
 BERTHON, 184  
 BESSUS, 176  
 BICKLE, P. 39  
*Bijou Camera*, 139  
 BING BROS., 165  
*Biograph*, 135, 146. P. 125. B. 128  
*Biographe*, 82. B. 73, 129  
*Biographe français*, 184  
*Biographe Léar*, 184  
*Biographe Soleil*, 185  
*Biokam*, 185, xiii.  
*Biopticon*, 154  
*Bioscope*, 132, 150, 213. B. 19, 129,  
   xiv.  
*Birtac*, 174  
 BLAIR, 100, 129, 196. P. 54, 77, 84  
 BLISS, SANDS & Co., 153  
 BONELLI, 113. P. 9, 10  
 BONN, P. 71  
 Book-form apparatus, 35, 149. P. 15,  
   27, 113, 119, 123, 140, 163. B. 99  
 Book-form, leaf-turning apparatus, 35,  
   36. P. 15, 91, 119, 163  
 BOULY, 186  
 BOYLE, 4  
 BRADLEY, 23. P. 11  
 BRENNAN, P. 34  
 BRESSARD, 184  
 BREWSTER, 5. B. 2  
 BROWN, 21, 46  
 BRUCE, 185  
 BRUNEL, B. 105  
 BUSCH, 221, xvii.
- CAMPBELL, 113, 152. P. 121, 157  
 CANNEVAL, 162. B. 129  
 CARBUTT, B. 50  
 Cards, mounted—  
   on band or strip, 37, 38. P. 119,  
   123, 136  
 Cards, mounted—  
   radially, 34, 35, 38, 39, 40. P. 2,  
   55, 57, 98, 119, 123, 136. B. 131  
   tangentially, 38, 40. P. 119, 123,  
   130, 155  
 Cards, resiliency of, preserving, 36, 38,  
   39. P. 98, 119, 163  
 CARETTE & Co., 184  
 CARPENTER, G. B. 32, 33  
 CASLER, 35, 36, 113, 135, 151. P. 55,  
   118, 119, 125. B. 128  
 CASSELLI, 186  
 CAVALLO, 4  
 Celluloid, 188  
*Centograph*, 187  
 CHARD, P. 85  
 CHASSERAUX, P. 43  
 CHÉRI-ROUSSEAU, 171. B. 145  
*Choreutoscope*, 20. P. 26  
 CHRISTOPHE, P. 87  
*Chromotrope* and its phenomena, 153.  
   P. 21, 64. B. 4  
*Chronophotographe*, 71, 108, 144, 149,  
   155, 201. P. 46. B. 51, 83, 87, 94,  
   118, 129  
*Chronophotographe d'amateur*, 82. P. 46.  
   B. 73, 84  
*Chronophotographer*, 149  
*Chronophotographoscope*, 187  
 Chronophotography—  
   first suggestion, 45. P. 8  
   principles of, 48, 56  
   methods of, 45, 48, 55. P. 8, 12, 19,  
   22, 24. B. 38, 39, 42, 46, 49, 51,  
   54, 55, 60, 66, 74, 89, 96, 105, 108,  
   129  
*Chronoscope*, 184  
*Cieroscope*, 185, xx., xxi.  
*Cinagraphoscope*, 187  
*Cineamatascope*, P. 105, 106  
*Cinécosmovama*, 162. P. 69  
*Cinéma*, 184  
*Cinematograph*, 143, 162, 165, 167, 176,  
   185. B. 126  
 CINEMATOGRAPH CO., 185  
*Cinématographe*, 93, 145, 160, 162, 185,  
   186, 201. P. 51, 68. B. 80, 96, 97,  
   105  
*Cinématographe Universel*, 184  
*Cinematoscope*, 98, 185  
*Cinémicrophonographe*, 184  
*Cineograph*, 163  
*Cinétographe*. See Kinetograph  
*Cinimatograph*, P. 105, 106  
*Cinograph*, 187

- Cinomograph*, 187  
*Cinoscope*, 187  
 CLAUDET, 7, 40. P. 2. B. 27, 29  
 CLÉMENT AND GILMER, 185, 193. B.  
     129  
 COHN, P. 164  
 Coin-freed. *See* Automatic  
 COLLINGS, P. 47, 67  
 Colouring films. *See* Films  
 Colours, natural, reproducing, 204. B.  
     64  
 COLT AND CO., 184  
 Compensation and feed-correcting de-  
     vices, 131, 136, 138, 148, 150, 183.  
     P. 33, 62, 74, 83, 95, 108, 120, 125  
 Continuous revolution (endless panora-  
     mic), 81. B. 65, 98, 132  
 COOK, P. 9  
 COPP, P. 107  
 CORDAY, 230  
 CORTHESEY, P. 123  
*Cosmonograph*, 187  
*Cosmoscope*, 187  
 COURTEEN, P. 37  
*Criterioscope*, 184  
 CROFIS, 67, 113. P. 33  
 Cylinders, slotted. *See* Dædaleum ;  
     Images arranged on cylinder, slotted ;  
     Zoëtrope  
*Cynnagraph*, 175  
  
*Dædaleum*, 22. B. 11  
 DALMEYER, 221, xxvii.  
 DARLING, P. 126  
 DAVY, P. 45  
*Dazzling Top*, 5  
 DE BEDTS, 184. P. 65. B. 129  
 DEMENY, 60, 61, 62, 82, 108, 128, 149,  
     201. P. 38, 42, 46. B. 61, 73, 83,  
     84, 87, 94, 129  
 DESVIGNES, 21, 22, 23, 25, 44, 51, 63.  
     P. 6  
 Developing. *See* Films  
 Diagrams, why unsatisfactory, 43  
*Diaramiscope*, 187  
 DICKSON, B. 69  
 Disc and shutter—  
     differential speed, 9, 16, 19, 51, 61.  
     P. 18, 20, 38. B. 38, 39, 47, 53,  
     61  
     identical speed, 15. P. 3, 7, 137  
 Discs, slotted. *See* Images arranged  
     on discs, slotted ; Phenakistoscope ;  
     Stroboscope  
 Distortion. *See* Slots  
  
 DOM-MARTIN, 184  
 DONISTHORPE, 51, 59, 62, 64, 67, 113.  
     P. 22, 33. B. 40, 106  
 DRITTLER, P. 130  
 Driving, 34, 37, 39, 46, 58, 71, 76, 78,  
     96, 105, 108, 131, 145, 155, 157, 166,  
     173, 176, 177, 183. P. 2, 33, 35, 37,  
     47, 55, 57, 58, 67, 70, 83, 88, 92, 97,  
     98, 100, 102, 108, 110, 116, 126, 128,  
     129, 145, 146, 161, 162, 164  
 Driving or moving film. *See* Inter-  
     mittent motion, etc.  
 DUBOSCQ, B. 19  
 DUCOS DU HAURON, 45  
 DU MONT, 45, 59. P. 8  
 DUNCAN, P. 112  
 DUNN, P. 151  
  
 EAMES, 91. B. 88  
 EASTMAN CO., 188  
 EDDY, 185  
 EDER, B. 134  
 EDISON, 51, 71, 73, 174. B. 56, 59,  
     69, 70, 71, 75, 100  
 EDWARDS, 45. P. 12, 25, 139  
*Eidoloscope*, B. 79  
*Electric Wonder*, 51. P. 40  
*Electrical Tachyscope*, 49, 74. P. 40.  
     B. 52  
*Electroscope*, 187  
 ELKAN, P. 135  
 ENGELMEYER, 186  
*English Kinematograph*, 173. P. 158  
*Eragraph*, 185  
 ERLANGER, P. 130  
*Eureka* toy lantern, 184  
 EUROPEAN BLAIR CO., 188. P. 54  
 EVANS, 65, 69, 70, 129. P. 32, 35. B.  
     57  
*Excelograph*, P. 131  
 Exhibiting hints, 207. B. 115, 122, 127,  
     135  
 Exposure. *See* Films  
  
*Fantoscope*, B. 10, 19  
*Fantoscope*, B. 20  
 FARADAY, 10, 13. B. 7  
*Faraday's Wheel*, 10. B. 7  
 FARNUM, P. 57, 59  
*Fenakistiscope*, P. 4  
 Film-boxes or catchers, 215  
 Film-feeding and tension devices, 133,  
     136, 141, 150, 165, 179, 183. P. 32,  
     54, 65, 66, 73, 77, 79, 82, 84, 86, 89,

- 96, 97, 105, 108, 125, 129, 142, 145,  
157, 165  
*See also* Compensation, etc.
- Film-traps and steadying devices, 52,  
70, 82, 83, 84, 104, 128, 133, 141,  
143, 144, 155, 161, 162, 164, 165,  
181, 211. P. 28, 36, 46, 53, 58, 60,  
62, 80, 81, 84, 85, 86, 89, 92, 95, 96,  
97, 101, 105, 108, 110, 126, 145, 150,  
161, 162  
*See also* Sprocket-wheels, locking
- Films—  
making, 188. B. 50  
gauge of, 170, 174, 179, 189  
perforations of, 71, 76, 79, 156, 174,  
190, 204. P. 28, 36, 68, 70, 72,  
78, 85, 100, 109, 112, 124, 135.  
B. 56, 113, 129, 140, i.  
exposing, 193. B. 128  
non-photographic, 166, 175, 184  
opaque. *See* Projection, aphenge-  
scopic  
printing positives on, 200. P. 51,  
83, 94, 104, 135. B. 113, 114, 115,  
118, i.  
developing, 195. P. 48, 90, 138, 143.  
B. 110, 112, 113, 115, 118, 119,  
123, 128, 143  
colouring, 84, 203  
repairing, 205. B. 122  
adjusting. *See* Adjusting, etc.  
winding, 215. P. 124, 135
- Filoscope*, 36. P. 163
- Fireproof Animatographe*, 176. P. 62
- FISHER, P. 5
- FITTON, 6. B. 26
- FLAMMARION, 231. B. 38, 141
- Flicker, 66, 208, 211. B. 109, 117
- FOERSTERLING, 185
- Foliographe*, 186
- Folioscope*, 35, 40. B. 99, 129, 131
- Following motion of object, 49, 59. P.  
21. B. 46
- FREER, 232.
- FRITSCH, 17. B. 107
- FROST, 152
- FUERST, 160
- Fusil photographique*. *See* Photographic  
Gun
- GASTINE, B. 108
- GAUTHIER, 184. P. 102
- GAUMONT, 149, 194, 197, 199, 210.  
B. 109
- Glycerine as heat-absorbent, B. 133
- GOODWIN, 189
- GRAY, 88, 123
- GRAYSON, P. 117
- GREENE, 65, 66, 84, 104. P. 32, 44.  
56, 83, 97, 147. B. 57, 58, 81
- GRIFFIN, 185, 207
- Grille*, 211, B. 109, 117
- GRIVOLAS, P. 142
- GRUNOW, P. 90
- GUÉROULT, 230. B. 89
- Gun, Photographic*. *See* Photographic  
Gun
- HANAU, 184, 198. B. 110
- HARRISON, P. 82, 141
- HARTLEY, P. 14
- HARVARD, 185
- HAWKINS, P. 41
- HAYDON, 185
- Heat absorption. *See* Safety, etc.
- HEINZE, P. 80, 95
- Helical arrangement of views. *See*  
Images, etc.
- Héliocinégraphe*, 155. B. 105, 129
- Héliographe*, 167. B. 129
- HEPWORTH, 222. P. 116. B. 111, 135
- HERSCHEL, 6. B. 26
- HEYL, 47. B. 136
- Historical notes. Chapters I, II, III,  
VII. Appendix I. B. 2, 20, 26, 32,  
33, 54, 60, 69, 74, 75, 77, 81, 82,  
85, 86, 90, 93, 96, 102, 103, 104,  
105, 106, 107, 108, 111, 120, 121,  
125, 126, 129, 134, 135, 136, 137,  
138, 139, 143
- HOLT, B. 133
- HORNER, 22. B. 11
- HOUGH, P. 52
- HUGHES, 20, 139, 205, 219, 223. P. 26,  
103, 150, 153, 162. B. 137
- HYATT, 188
- HYMMEN, P. 140
- Hypnoscope*, 187
- Illuminant, moving, 18, 66. B. 23, 107
- Illumination, intermittent, of moving  
image, 14, 19, 43, 50, 51, 62, 74, 76,  
87, 112. P. 1, 6, 22, 33, 38, 40, 60,  
63. B. 18, 30, 40, 44, 52, 62, 78
- Illumination, overlapping, 40, 52, 80.  
P. 28  
*See also* Alternate, etc.
- Illumination, systems of, 14, 18, 76,  
87, 165, 173, 174, 218. P. 33, 63,  
103, 116. B. 68, 76, 135

- Image optically stationary by—  
 cyclostat or moving prism, 85, 113.  
 P. 23. B. 67  
 mirrors, 27-31, 57, 113, 151, 152,  
 171. P. 23, 31, 118, 121, 157, 165.  
 B. 41, 43, 45, 48, 62, 145  
 momentary vision. *See* Illumina-  
 tion, intermittent  
 moving lenses, 26, 86, 92, 113, 147.  
 P. 10, 74, 83. B. 36
- Image relatively stationary by double  
 motion, 67, 113. P. 33, 139
- Images arranged—  
 in spiral or helix, 38, 62, 73, 74, 100,  
 152, 153. P. 38, 42, 52, 55, 98,  
 144, 152. B. 142  
 on bands or strips, 20, 23, 27, 29,  
 37, 41, 45, 50, 52, 63, etc. P. 6,  
 16, 17, 22, 28, 29, etc. B. 12, 4,  
 51, 55, etc., 120  
 on cylinder, slotted, 22. P. 6, 11, 13,  
 22  
 on cylinder, unslotted, 45, 62, 73, 74,  
 100. P. 7, 8, 38, 39, 52, 121, 157,  
 165. B. 25, 27  
 on disc, slotted, 11-14. P. 137. B.  
 44  
 on disc, unslotted, 15, 16, 17, 19, 20,  
 31, 46, 47, 49, 51, 58, 60, 61, 66,  
 74, 152, 153. P. 3, 7, 9, 10, 12,  
 18, 19, 20, 38, 60, 107, 144, 152.  
 B. 46, 47, 52, 53, 61, 136, 142  
 on spiral film, 85. B. 67
- Indicating consumption or speed. *See*  
 Speed, etc.
- Inspection apparatus, 50, 61, 62, 85, 87,  
 100, 105, 152, 173, 222. P. 38, 49,  
 58, 65, 73, 87, 108, 121, 153, 157,  
 158, 165. B. 90, 144  
*See also* Kinéscope; Kinetoscope;  
 Kinora; Mutoscope; Phenakisto-  
 scope; Photozootrope; Praxino-  
 scope; Stroboscope; Viviscope;  
 Zoétrope
- Interferenzoscop.* B. 21
- Intermittent illumination. *See* Illumi-  
 nation
- Intermittent motion by—  
 clamp or brake, 52, 64, 71, 98, 103,  
 130, 144. P. 35, 53, 109. B. 51,  
 55, 118  
 claw or spring-teeth, 91, 95, 100,  
 120, 123, 125, 155, 161, 162,  
 167, 169, 172, 178, 181. P. 51,  
 54, 68, 76, 78, 85, 83, 96, 100,  
 101, 106, 108, 110, 115, 126, 141,  
 145  
 disconnecting friction-gear, 122. P.  
 35  
 double motion of rollers, 69, 120, 122,  
 146. P. 35, 80, 83, 92  
 eccentric bobbin or sprocket, 82, 119,  
 139, 168. P. 46, 83  
 eccentric dog, pitman, etc., 83, 108,  
 128, 133, 139, 150, 166, 173. P.  
 46, 60, 95, 104, 106, 120, 158  
 escapement, 34, 35, 36, 37, 39, 40,  
 64, 65, 78, 118, 122, 149, 155,  
 156. P. 30, 32, 39, 41, 43, 57, 70,  
 72, 75, 99, 115, 146  
 gripping blocks or rollers, 69, 122,  
 128, 135. P. 35, 80, 85, 87, 95,  
 109, 125, 142, 161  
 Maltese Cross. *See* wheel and pin  
 plates passed from one chamber to  
 another, 45, 59. P. 8, 22, 87, 133  
 rack and teeth, 20, 158. P. 26, 114,  
 131  
 ratchet or tappet-gear, 47, 60, 80, 120,  
 145, 162. P. 2, 39, 47, 67, 69, 76,  
 86, 87, 93, 102, 112, 132, 149  
 reciprocated arm, etc., 70, 84, 104,  
 129, 140. P. 35, 36, 44, 58, 77,  
 83, 84, 97, 124, 150  
 rocking shaft, P. 151  
 roller rotating between band and  
 fixed cylinder, 41. P. 59.  
 snail, 15, 118, 155. P. 115. B. 32  
 wheel and—  
 cam-groove or worm, 102, 116,  
 118, 143, 150, 153, 158, 165,  
 166. P. 28, 61, 66, 73, 79, 81,  
 82, 89, 135, 144, 152  
 pin, 21, 46, 58, 114, 162, 164, 166,  
 167, 174, 175, 176, 177. P. 25,  
 60, 62, 65, 70, 105, 111, 156  
 traversed worm, 107. P. 71  
 wheel, partially toothed, 105, 114.  
 P. 56
- Intermittent motions, general review  
 of, 111
- Inventor of Living Pictures, 226
- Invicta Cinematograph*, 167
- IREX, B. 78
- IVES, P. 159
- JANSSEN, 57, 59. B. 38, 39
- JAUBERT, 184
- JEFFRIES, B. 34



- JENKINS, 74, 86, 107, 128, 190, 193, 200, 223. B. 72, 90, 91, 100, 112, 113, 114, 138, 139, 140
- JOLY, 104, 145, 202, 222. P. 58, 92, 93, 94. B. 92, 105, 129
- JONES, P. 131
- JUNDZILL, P. 3
- Junior Prestwich*, 169
- KAISER, 162. B. 129
- Kaleidorama*, 14. B. 14
- Kalotrop*, 9
- KAMM, P. 152
- Kathoscope*, 187
- Katopticum*, 187
- Kinetleposcope*, 187
- Kinedogoscope*, 211
- Kinegraph*, 186
- Kinematodor*, 175
- Kinematograph*, 150, 166, 173, 179
- Kinematoscope*, 173
- Kinematoterm*, 187
- Kineograph*, 35. P. 15
- Kineopticon*, 98
- Kineoptoscope*, 172
- Kinéscope*, 33. P. 17. B. 35, 130
- Kinesetograph*, 187
- Kinesigraph*, 51, 64. P. 22. B. 40, 106
- Kinesterograph*, 187
- Kinetic Camera and Lantern*, 97, 98. P. 53. B. 86, 103
- Kinetinephone*, 187
- Kinetograph*, 73, 156, 158, 162, 179, 184, 207. P. 89. B. 56, 59, 69, 93, 105, 129.
- Kinetophone*, 74
- Kineto-phonograph*, B. 69, 70
- Kinetoscope*, 51, 73, 75, 112, 174. B. 69, 71, 75, 81, 96
- Kinetoscope, pocket*, 35
- Kinetoscope stereopticon*, B. 100
- Kinetoscopes, multiple*, 105, 106, 222. P. 49, 73. B. 92, 129
- Kinetoscopic Camera*, B. 100
- Kinevitagraph*, 187
- Kinimoscope*, P. 3
- Kinora*, 39. P. 98
- KOOPMANN, P. 109
- KORSTEN, P. 89. B. 129
- KRONKE, P. 133
- KUMBERG, P. 66
- LACROIX, 155. B. 105, 129
- LAING, B. 28
- LAMBERT, P. 137
- LANGHAM, P. 136
- LANGLOIS, 33. P. 17. B. 35
- Lantern Wheel of Life*, 17, 19, 112. P. 18, 20, 107. B. 47
- LA PIPE, 149, 192. P. 99. B. 129
- Lapiposcope*, 149. P. 99. B. 129
- LATHAM, 112. P. 63, 120. B. 79
- LÉAR, 184
- Leaves, views on. *See* Book-form; Cards
- LEBIEDZINSKI, B. 95
- LE FRANCCIS, B. 4
- Lenses, mounts and fittings, 164, 176, 220, xvii., xxvii.
- LE PRINCE, 52, 79. P. 28
- LEVI AND CO., 175
- LEVI, JONES AND CO., 185
- LIDDELL, P. 124
- LIESGANG, 186
- LINCOLN, 21
- Line of sight or projection, deflecting, 76, 89, 159, 162, 175. P. 49, 50, 114. *See also* Projection, auxiliary
- LINNETT, 35. P. 15
- Living Picture Book*, P. 27
- LOCKE, 186
- LOMAX, P. 49. B. 93
- LOMMEL, 14, 62, 112. B. 44
- LONDE, 53. B. 54, 66, 145
- LUB'N, 163
- LUCRÉTIUS, 3. B. 20
- LUMIÈRE, 30, 93, 160, 188, 201, 216. P. 51, 68, 98. B. 80, 97, 115, 116
- Luminograph*, 187
- MCDONALD, P. 81
- MACH, 230
- MACLETYRE, 232
- MACKUSICK, P. 48
- McNALLY, P. 113
- Magic disk*, 22. *See also* Zauberschiebe
- Maguscope*, 187
- MARESCHAL, B. 73, 94, 117
- MAREY, 25, 48, 59, 69, 71, 82, 144, 197, 202. B. 46, 51, 55, 60, 74, 118
- Marionette Top*, 31. B. 45
- MAROUSSEM, P. 75
- MARTIN, 55
- MASKELYNE, 113, 146. P. 74
- Masks. *See* Adjusting, etc.
- Matagraph*, 185
- MATUSZEWSKI, 231

- MAURICE, P. 16  
 MAXWELL, 26, 113, 146. B. 36  
 MAYER, 80  
 MAZO, 167. B. 129  
 MÉLIÈS, 158. P. 89. B. 105, 129  
 MELVILLE, P. 27, 91  
 MESSENGER, 167. B. 129  
 MESSER, 156, 193, 197, 207  
*Micrograph*, 163, 223, xxvi.  
*Micromicroscope*, 232. B. 124  
 Microscopic chronophotography, 72.  
   B. 74, 124  
 Microscopic views, 33. P. 9, 10, 17.  
   B. 35, 130, 142  
 MILLER, P. 151  
 Miniature Cinematographs, 169, 174,  
   185, xiii., xvi.  
   *See also* Toy lanterns  
 MOIGNO, B. 19  
 MOLTENI, B. 47  
 MONNARD, B. 142  
 MONTSERRET, B. 110  
 MOON, P. 149  
 MORRISON, P. 146  
 MORTIER, 171. B. 145  
*Moto-Bijou Camera*, 139  
*Motograph picture book*, 153. P. 64  
*Moto-Photoscope*, 139  
*Motograph*, 156  
*Motoroscope*, B. 28  
*Motor-Pictoscope*, 140  
*Motroscope*, 187  
*Mouvementographe*, 165. B. 105  
*Mouvementoscope*, 187  
*Movendoscope*, 185  
 MOY, P. 141  
 MÜLLER, 14, 103. B. 16  
 Multiple optical systems. *See* Optical  
   systems, etc.  
*Mutagraph*, 146. P. 74  
*Mutograph*, 135, 185. P. 125. B. 128  
*Mutograph* dark room, 195. B. 128  
*Mutograph* studio, 194. B. 128  
*Mutoscope*, 36, 37, 38, 139. P. 55, 119,  
   136  
*Mutoscope*, 187  
 MUYBRIDGE, 48, 51. P. 24. B. 42, 49,  
   53  
 NAISH, 162. P. 101  
 NELSON, 153. P. 144  
 NEUMANN, 185  
 NEVE, P. 132  
 NEWMAN, P. 96, 145  
 NEWMAN AND GUARDIA, LTD., 179. P.  
   96, 145, i., ii.  
 NEWTON, 4, 173. P. 158, 159  
 NOAKES, 167  
 NOBLE, P. 124, 158  
 NOLLET, 4  
 Nomenclature, 185  
 NORDISK REKLAME KOMPAGNI, P. 156  
 NORMAN, 167  
 NORMANDIN, 145. B. 105, 129  
 OBELT, P. 105, 106  
 O'NEILL, P. 113  
 ONIMUS, 55  
*Optic Wonder*, 4  
 Optical systems, duplicate and multiple,  
   18, 86  
   *See also* Alternate; Battery; Projec-  
   tion, auxiliary  
*Optical Theatre*, 30. B. 62  
*Optigraph*, 185  
 OTTWAY, 175  
 OULTON, P. 70, 115  
 PACHT, P. 161  
*Panoramograph*, 187  
*Pantaminiograph*, 187  
*Pantobiograph*, 187  
*Pantomimographe*, 167. B. 129  
 PARIS, 5, 6. B. 2  
 PARNALAND, 161. P. 72, 78, 110  
 PARSONAGE, P. 154  
 PAUL, 176. P. 62  
*Pedemascope*, 33. P. 39  
 Peep-show apparatus, 223. P. 153.  
   B. 90  
   *See also* Inspection apparatus  
*Perfection Cinematograph*, 185, xv.  
 Perforations. *See* Films  
 PERRET, 155. B. 105, 129  
 Persistence of Vision, 1, etc.  
 PESCHEK, P. 85  
 PETIT, 101, 105. P. 73  
*Phanakistiscope*, P. 3  
*Phanakistiscope*, P. 16. B. 10, 13, 47  
*Phantascope*, 14, 186. B. 14  
*Phantasmaskop*, B. 13  
*Phantograph*, 187  
*Phantoscope*—  
   Camera, 86. B. 72, 90, 91, 100, 114  
   Projector, 107. B. 90, 91, 100  
*Phasmatrope*, 47  
*Phenakistiscope*, P. 23  
*Phenakistiscope*, P. 14

- Phenakistoscope*, 11, 13, 112. P. 137.  
 B. 9, 10, 13, 14, 32  
 See also Stroboscope  
 —, alleged anticipation of, 3. B. 20  
 —, stereoscopic, 40. P. 3. B. 19,  
 27, 28, 77  
 PHILLIPS, P. 37  
 Phonograph combined with Living  
 Pictures, 62, 73, 184. P. 38, 93.  
 B. 40, 69, 70  
*Phono-kinetograph*, 73  
*Phono-kinetoscope*, 74  
*Phonomendoscope*, 187  
*Phonoscope*, 61, 112. P. 38, 42. B. 61  
*Photochronographe*, 71, 82  
*Photo-cinégraphie*, B. 89  
*Photokinematograph*, 187  
*Photographic Gun*, 59. B. 46, 74  
 — *Revolver*, 57. B. 38, 39  
 Photography, first application and in-  
 fluence, 44, 47, 62, 63, 68, 74, 228  
*Photomotoscope*, 187  
*Photophone*, 61. B. 108  
*Photoramic Effects*, 186  
*Photo-rotoscope*, 142  
 — *Peep-show*, 223. P. 153  
*Photoscope*, 33. P. 17  
*Phototrope*, 187  
*Photozootrope*, 222. B. 92, 129  
*Pictorialograph*, 185  
 PILKINGTON, 32  
 PIROU, 185  
 PLATEAU, 3, 9, 10, 13, 16, 26, 44, 112,  
 226. B. 3, 5, 8, 9, 10, 15, 17, 20  
*Pocket Kinetoscope*, 35  
 POPLAWSKI, B. 95  
 POPPE, 14. B. 21  
 PORTER, P. 122  
 Posed subjects, unreality of, 44, 45, 47.  
 B. 82  
 Positives, making. See Films  
 POTTER, 64. P. 29  
*Praxinoscope*, 26, 113. P. 23. B. 41  
 —, *Projection*, 29. P. 23. B. 48  
 — *Projection Theatre*, 30. P. 31.  
 B. 62, 79  
 —, Stereoscopic, 28  
 — *Theatre*, 28, 29. P. 23. B. 43  
 —, Theory of, 27  
 PRESTWICH, 167. P. 83, xvi.  
*Projecting Kinetoscope*, 174  
 Projection—  
 aphenegoscopic, 68, 86. P. 33  
 auxiliary systems for ordinary views,  
 29, 135, 142, 162, 163, 183, 212.  
 P. 80, 101, 105, 129, 150, 159  
 162  
 first instruments for, 16, 29, 33, 46,  
 47, etc. P. 14, 18, 20, 23, 25, 26,  
 28, etc. B. 23, 37, 85, 107  
*Projection Praxinoscope*, 29. P. 23. B.  
 48  
*Projectoscope*, 174  
 PROKESCH, 17. B. 107  
 PTOLEMY, 3  
 PURSER, xvii.
- QUETELET, 13
- RADAU, B. 30  
 Radio-kinetograms, 232  
 RAE, B. 119  
 RATEAU, 155. P. 108, 129  
*Rateaugraph*, 155  
 RAY, P. 21  
*Rayoscope*, 187  
 REICH, P. 76, 112  
 Repairing films. See Films  
 REULOS, 158. P. 89. B. 105, 129  
 Reversing, 105, 173, 176, 213. P. 62,  
 73, 128, 158. B. 89, 94  
 RÉVILLE, B. 120  
*Révolver photographique*. See Photo-  
 graphic Revolver  
 REYNAUD, 26, 29, 113. P. 23, 31. B.  
 41, 43, 45, 48, 62, 79  
 REYNER, B. 120  
 RICE, P. 151  
 RICHARDS, P. 79  
 RIGG, 150. P. 66  
 RILEY, 172  
 ROBINS, B. 121, 122, 123  
 ROGET, 9. B. 1  
 ROLLMANN, B. 22  
*Rollograph*, 175  
 ROSE, 9. P. 13  
 ROSENBERG, 143. P. 81  
 ROSS, 19. P. 18, 20  
 ROUTLEDGE, P. 81  
 ROWE, 185  
*Royal Biograph*, 146  
 RUDGE, 66. B. 58
- Safety arrangements, 76, 142, 157, 163,  
 176, 216. P. 60, 81, 116, 156, 162.  
 B. 115, 116, 133  
 ST. CLAIR, B. 124  
 SANDOW, P. 127  
 SANSON, 162. P. 69  
 SAVART, 14

- Scenamotograph*, 187  
*Scenetograph*, 185  
 SCHMIDT, P. 87  
 SCHWARZ, P. 138  
 Screens, 220  
 SEARS, ROEBUCK, & Co., 185  
 SÉBERT, 53. B. 54  
 Sectional change over whole surface of picture, 42. P. 34 B. 63  
 SEGNER, 4  
*Series Apparatus*, 148  
 Series on separate plates. *See* Intermittent motion by plates, etc.  
 SHAW, P. 7, 70. B. 25  
 SHORT, 36. P. 61, 163  
 Shutters, special forms of, 14, 17, 19, 20, 47, 49, 52, 54, 70, 77, 84, 92, 100, 105, 129, 133, 141, 149, 160, 165, 168, 175, 181, 209, 222. P. 32, 33, 36, 44, 46, 51, 52, 54, 56, 58, 62, 68, 70, 71, 73, 75, 77, 78, 79, 80, 84, 85, 86, 88, 95, 99, 101, 104, 106, 111, 120, 126, 129, 132, 150, 152, 162  
 SINSTEDEN, 3. B. 20  
 SKLADNOWSKY, 106, 148  
*Slipping-slides*, 33  
 Slots—  
   and images, relation between, 11, 12, 23, 24. P. 11. B. 21, 22, 30, 117  
   distortion caused by, 9, 25. B. 11, 14  
   *See also* Anorthoscope  
 SMITH, P. 104  
 SNELL, 14. B. 14  
*Sobroscope*, P. 3, 16  
 Speed, etc., governing and indicating, 155, 163, 168, 181, 183. P. 33, 80, 83, 129, 145, 150  
 Speed of view, varying, 230, 232. B. 89  
 Spiral arrangement of views. *See* Images, etc.  
*Spiral Camera and Lantern*, 152, 153. P. 144, 152  
 Spools—  
   driving, 71, 138, 150, 157. P. 36, 62, 63, 68, 73, 79, 83, 84, 150  
   for cameras, 150, 157, 183. P. 83  
   forms of, 218. P. 79, 80, 81, 88, 95, 125  
   mounting, etc., 134, 142, 165, 178, 179, 183. P. 44, 105, 145, 162  
 Sprocket wheels—  
   locking, 78, 80, 102, 115, 117, 118, 120, 121, 141, 143, 162. P. 69, 70, 71, 72, 73, 75, 76, 86, 102, 112, 150, 151, 162  
 STAMPFER, 13, 63. B. 12  
 Stands, 193, 207, i.  
*Steenomatographe*, 172  
*Stéréo-fantoscope*, B. 19  
*Stereopticon*, 187  
 STEREOSCOPIC Co., 4  
 Stereoscopic devices, 7, 24, 25, 28, 40. P. 2, 3, 4, 5, 6, 7, 21, 36, 42, 44, 87, 121, 122, 127, 140, 160. B. 19, 24, 25, 27, 28, 77, 120  
*Stereo-thaumatrope*, 7. B. 29  
*Stereotrope*, B. 25, 77  
*Stereo-Zootrope*, 25. B. 74  
 STERNBERG, P. 135  
 STEWARD, 152  
*Stinctiscope*, 187  
 STOCK, 185  
 STORY, B. 81  
*Stroboscope*, 13. P. 3. B. 12, 13, 14, 16, 22, 30, 37, 44, 78  
   *See also* Phenakistoscope  
 SYMONS, P. 64  
  
*Table Kinematoscope*, 173  
*Tachyscope*, 25, 49  
 —, *Electrical*, 49, 74. B. 52  
 TALBOT, FOX-, 43. P. 1  
 TALBOT AND EAMER, xix.  
*Taumatograph*, 187  
 TAYLOR, 186. P. 155  
*Télécinématographe*, B. 142  
 TERME, P. 75  
*Thaumatograph*, 158  
*Thaumatrope*, 5. B. 2, 32, 34, 64  
 —, invention of, 6. B. 2, 26  
 —, *Stereo*-, 7. B. 29  
 —, vertical, 32  
*Theatregraph*, B. 93  
*Théâtrixinoscope*, 30  
*Theatroglyph*, 176  
 THOMPSON, B. 75  
*Thromotrope*, 187  
 TISSANDIER, B. 41, 42, 43, 48, 62  
*Top, Dazzling*, 5  
*Top, Marionette*, 31  
 TÖPLER, B. 30  
*Toupie éblouissante*, 5  
*Toupie-fantoché*, 31. B. 45  
 Toy lanterns, 149, 166, 175, 184  
 TREVOR, P. 19



- Tropescope*, 186  
*Tropograph*, P. 57  
 TYNDALL, 43. B. 18
- UCHATIUS, 16, 17, 87. B. 23, 107  
 URRY, 185  
 Uses of Kinetography. *See* Applied  
 to, etc.
- VALENTA, B. 134  
*Variscope*, 187  
 VARLEY, 70, 84, 129. P. 36  
*Vélocigraphe*, 186  
*Velograph*, 185  
*Velotrope*, 186  
*Venetropé*, 187  
 Venus, Transit of, 57. B. 38, 39  
*Veriscope*, 166  
 VEVERS, 185  
 Vibration, preventing, etc., P. 78  
*See also* Flicker  
*Vibroscope universel*, B. 30  
*Vieograph*, 185  
 VINCI, LEONARDO DA, 4  
*Viroscope*, 187  
*Virtoscope*, 187  
 Vision. *See* Alternate; Line of sight;  
 Persistence  
*Visionoscope*, 187  
*Vistascope*, 185  
*Vitagraph*, 185. B. 129  
*Vitaleitroscope*, 187  
*Vitamotograph*, 187  
*Vitaphotoscope*, 177  
*Vitascope*, 74, 184. P. 60, 105. B. 100  
*Vitograph*, B. 93  
*Vitopticon*, 187  
*Vitoscope*, B. 93  
 VITOUX, B. 96  
*Vivendograph*, 187  
*Viviscope*, 41. P. 59. B. 101  
*Viviograph*, 185  
*Vivrescope*, 187  
 VOLKMER, B. 97
- WARD, B. 125  
 WARWICK TRADING CO, 132, 185, 214,  
 xiii., xiv.  
*Watëroscope*, 187  
 WATILLIAUX, 35, 40. B. 99, 129, 131  
 WATKINS, 232. B. 124  
 WATSON, 156  
 WEBER, B. 31  
 WENHAM, 45. B. 82  
 WERNER, P. 100  
 WHEATSTONE, 15  
*Wheel of Life*, 21  
*See also* Lantern Wheel, etc., Zoë-  
 trope  
 Wheel Phenomena, 9, 10, 11. B. 1, 3,  
 4, 5, 6, 7, 8, 14, 117  
 WIGHT, P. 143  
 WILSON, P. 160  
 Winding films. *See* Films  
 WOLFF, 177, xxii., xxiii.  
 WOLLASTON, 6  
*Wonderscope*, 187  
 WOOD, 185  
 WRAY, 178. P. 50, 88, 115, xv.  
 WRENCH, 165. P. 86, 126. B. 126
- X-ograph*, 187  
 X-ray Kinetograms, 232
- Zauberschiebe*, B. 12  
 ZEISS, 221  
*Zeoptrotrope*, 187  
*Zinematograph*, 187  
 ZIZMANN, B. 37  
 ZION, 165. B. 105  
*Zoëtrope*, 21, 23, 59, 72. P. 6, 11, 13,  
 22, 37, 45. B. 32  
 band-form, 63. P. 6  
 non-distorting, 26. B. 36  
 stereoscopic, 24, 25, 40. P. 6 B.  
 25  
*Zoöpraxiscope*, 51, 112. B. 53  
*Zootrope*, 21. B. 36  
 —, stereo (solid figures), 25. B. 74

## ERRATA.

---

Page 31, line 5, *for* Toupée *read* Toupie.

Page 50, line 3, *for* current *read* contact.

# The Animated Photography for Amateurs

# *Biokam.*

REGISTERED

(PATENTED IN ALL COUNTRIES.)

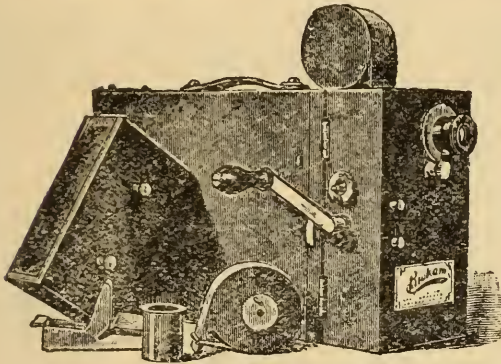

A Combined Cinematograph and Snap-shot Camera, Printer, Projector, Reverser, and Enlarger. Fitted with

**TWO SPECIAL VOIGTLANDER LENSES.**

PRICE:

**£6 6s. 0d.**

## THE BOKAM PROJECTOR

For Projecting, Reversing and Enlarging only.  
Fitted with Adapter to screw into Lens Flange of  
**ANY EXISTING LANTERN.**

**Price: £4 4s. 0d.**

**SENSITIVE FILM**, Positive or Negative, perforated (length 25ft.) **3/6** each.

**BIOKAM FILM SUBJECTS**, 25ft. full length, price **10/-** each.

*Same duration of exhibit as Films used for Public Cinematograph Entertainments.*



SEND FOR HANDSOME ILLUSTRATED CATALOGUE.

For Sale by all OPTICIANS and PHOTOGRAPHIC DEALERS.

**THE WARWICK TRADING Co., Ltd.,**

4 & 5, WARWICK COURT, HIGH HOLBORN, LONDON, W.C.

Telegrams: "COUSINHOOD, LONDON."

Telephone: "1135, HOLBORN."

# The KING OF CINEMATOGRAPHS.



## CAMERAS & PROJECTORS

(PATENTED).

2,000 LATEST FILM SUBJECTS.



The Superior "W.T.C." Films  
 The Celebrated Melies "Star" Films  
 The Famous Lumiere Films  
 The Ingenious "G.A.S." Films

(COPYRIGHTED).

THE . . .  
 HEPWORTH OPTICAL  
 ELECTRIC LAMP,  
 And all Accessories pertaining  
 to the  
 CINEMATOGRAPH TRADE.

SEND FOR CATALOGUES  
 Of New Model Bioscopes  
 and Film Subjects.

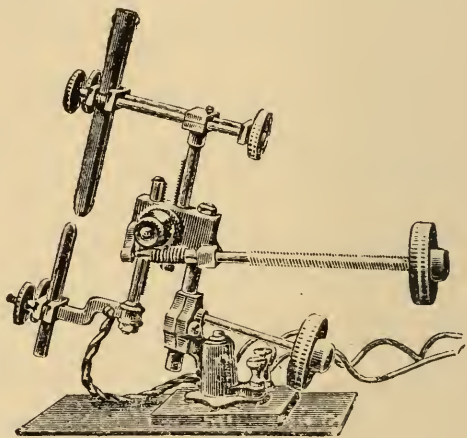

### THE WARWICK TRADING CO., LTD.,

4 & 5, Warwick Court, High Holborn,

London, W.C.

Telegrams :—" COUSINHOOD, LONDON."



# Cecil Wray & Co.

(Late BAXTER & WRAY),

MAKERS OF - - - - -

## CINEMATOGRAPHS, LANTERNS, &c.,

BOROUGH MILLS, Telegrams: PROJECTOR, BRADFORD.

Telephone: No. 944. - - BRADFORD, YORKS.



**SPECIALITIES:**



## THE PERFECTION CINEMATOGRAPHS,

Which can be fitted to any Magic Lantern, and will take Films of any length, from 50 feet to  $\frac{1}{2}$  a mile.

**No wear on Films, after months of use.**

**Flicker reduced to minimum.**

**Never gets out of order.**

**Used by the leading Professional Exhibitors.**

Each Machine fully tested and guaranteed for 12 months, and any part broken or worn during that period replaced *Free of Cost*. During the last three years over 350 Machines have been supplied.

The action of this Machine is fully described on Page 178 of this book.

**IF YOU WANT THE BEST, GET THIS!**

**PRICES FROM 50/- TO £20,**

According to customer's requirements. Any of our Machines will photograph as easily as project. Any information or estimates cheerfully supplied, and any work in connection with Cinematographs carried out by Specialists.

 In this Business we have led, others have followed.

FOUR PRIZE MEDALS HAVE BEEN AWARDED OUR APPARATUS.

## The "PRESTWICH" Specialities for ANIMATED PHOTOGRAPHY

Nine different Models of Cameras and Projectors in three sizes for  $\frac{1}{2}$ in.,  $1\frac{3}{8}$ in. and  $2\frac{3}{8}$ in. width of film.

We make and supply everything appertaining to Cinematographs.  
**CAMERAS, PROJECTORS, PERFORATORS, &C.**

*Constructed on an entirely new principle. Perfect Register,*

This Camera will carry from 400 to 500 ft. of film without changing, and the magazines being light-tight the operation of filling-in is done in daylight.

Focussing can be done directly on to the film.

As a Printer this instrument is *perfect*, giving absolutely correct registration and masking. Will print 500 ft. in one length.

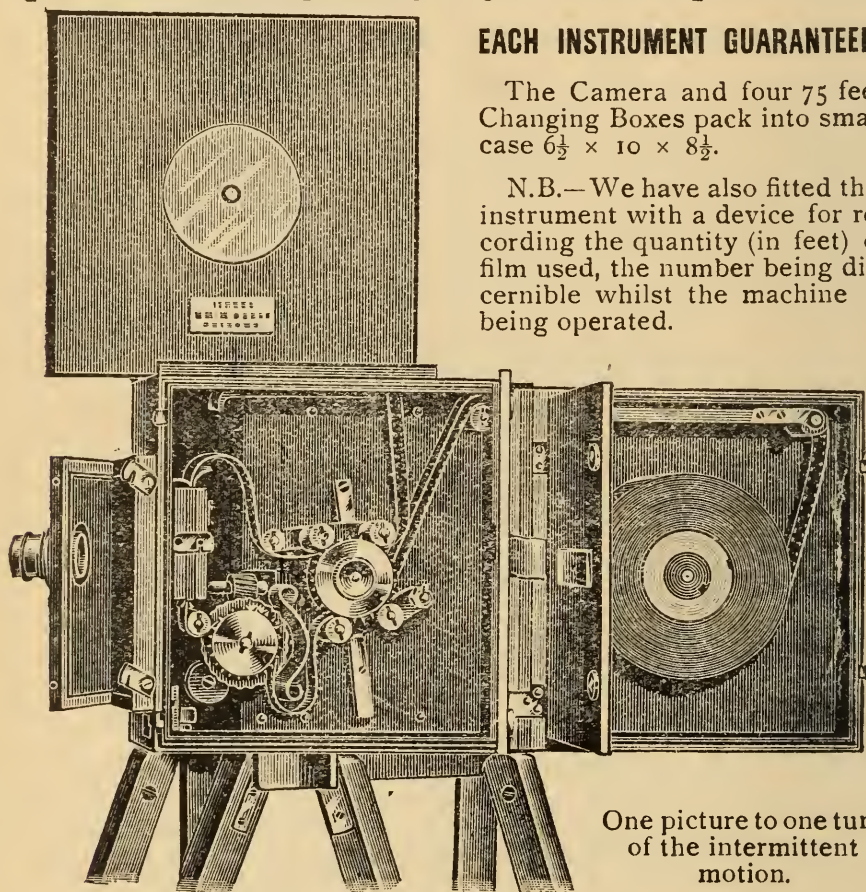

### EACH INSTRUMENT GUARANTEED.

The Camera and four 75 feet Changing Boxes pack into small case  $6\frac{1}{2} \times 10 \times 8\frac{1}{2}$ .

N.B.—We have also fitted this instrument with a device for recording the quantity (in feet) of film used, the number being discernible whilst the machine is being operated.

One picture to one turn  
of the intermittent  
motion.

The "Prestwich" Combined Magazine Camera & Printer (Patent). Model 4.

*For further particulars send for our New Illustrated Catalogue.*

**THE PRESTWICH MANUFACTURING CO.,**  
744, High Road, Tottenham, London, N.

**FOCUS YOUR ATTENTION**



ON

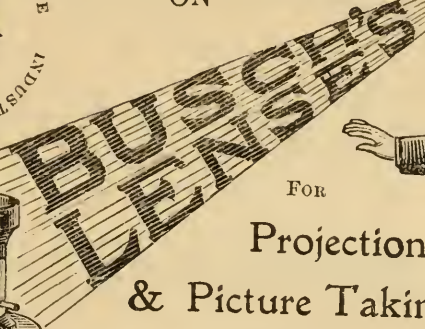
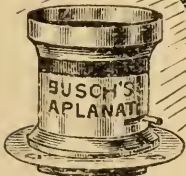

FOR

Projection

& Picture Taking.

OBTAIN LIST.

WHOLESALE AGENT

**HENRY F. PURSER.**  
33 HATTON GARDEN LONDON. E.C.

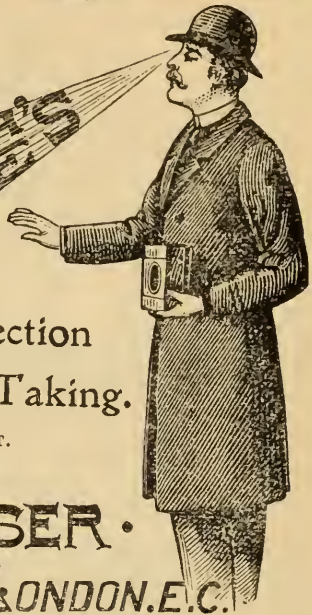

THE  
**OPTICIAN'S HANDBOOK,**

BEING

*An Introduction to the Study of the Refraction of the Eye.  
Its Anomalies, and their Estimation and Correction  
by Means of Glasses,*

BY AN

OPHTHALMIC SURGEON (M.R.C.S.E.)

**PRICE 3/6.**

THE GUTENBERG PRESS LD.,

123, 124, & 125, Fleet St., London, E.C.



# BAMFORTH'S

## Life Model \* Lantern Slides, Illustrated Songs, &c.

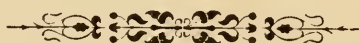

The Largest Producer in the World.

---

---

*Detailed Catalogue, 208 pages, post free, 8d.*

---

---



Slides made from Customers' Negatives by a Special Wet  
Collodion Process, giving good results even from  
poor, weak film Negatives.



Send Negative for Sample Slide and Terms.

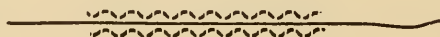

## JAMES BAMFORTH,

Station Road, Holmfirth, Yorkshire, England.



# Historical Facts!

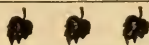

## TALBOT AND EAMER ◇

were the first to place a cheap hand camera on the market . . . "THE DIAMOND DETECTIVE."

## TALBOT AND EAMER ◇

were the first to introduce cheap dark slides.

## TALBOT AND EAMER ◇

were the first to supply hand cameras fitted with large finders . . . "THE JALMER."

## TALBOT AND EAMER ◇

were the first to introduce a cheap and efficient roller-blind shutter . . . "THE MERTAL."

## TALBOT AND EAMER ◇

were the first to place on the market a practicable reflex hand camera, having a full-sized picture . . . "THE MIRAL,"



The improved "MIRAL" takes any lens, and can be fitted with bag changing arrangement, dark slides, changing box, or roll-holder. No larger than any ordinary box camera. Send for full particulars and illustrations of our various pattern hand cameras, field cameras, shutters, etc., to the manufacturers—

## TALBOT AND EAMER, BLACKBURN.

APPLETON'S "The Cieroscope."  
Cinematograph -

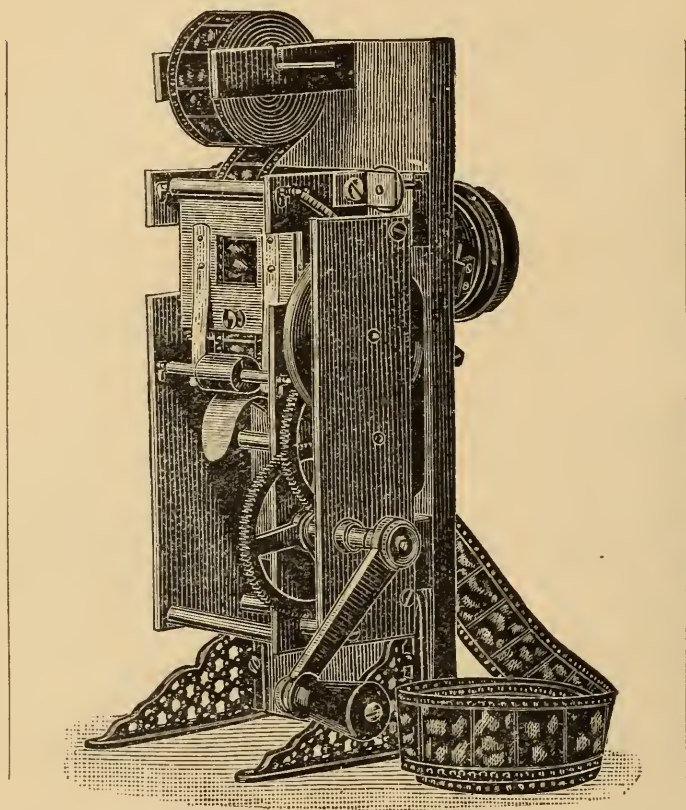

CIEROSCOPE No. 1, for Projection purposes only, fitted with new pattern Shutter, complete with Lens.

**The most reliable Machine on the Market.**

**Price - £15 15s. Od.**

CIEROSCOPE, as No. 1, with best Mahogany Lantern and Alum Trough, complete —

**£21 0s. Od.**

R. J. APPLETON & CO.,  
58, MANNINGHAM LANE, BRADFORD.

Telegrams: "OPTICAL, BRADFORD."

# APPLETON'S "The Cieroscope."

Cinematograph -

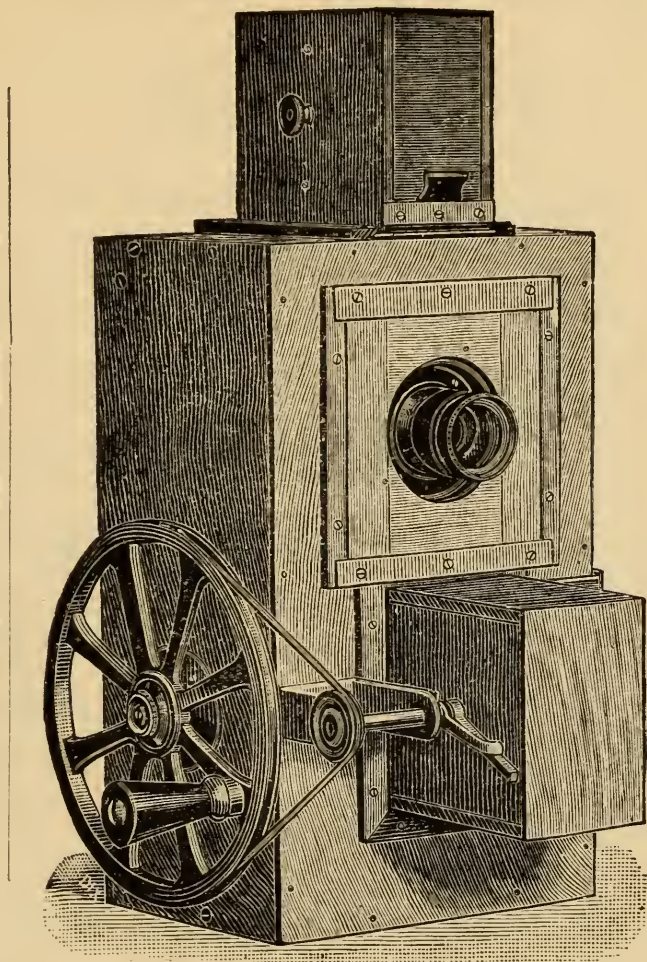

**CIEROSCOPE CAMERA AND PROJECTOR**, for Taking and Exhibiting Cinematograph Films, fitted with a pair of daylight changing boxes, avoiding the necessity to return to the Dark Room to put the Film into the Camera.

Price— { With W. Wray's Lens - £17 17s. 0d.  
 { Without Lens - - - - £15 15s. 0d.

A LARGE QUANTITY OF FILMS IN STOCK. CATALOGUES FREE.

**R. J. APPLETON & CO.,**  
**58, MANNINGHAM LANE, BRADFORD.**

Telegrams: "OPTICAL, BRADFORD."

PHILIPP WOLFF,

9 & 10, Southampton

BERLIN.

## PROJECTORS

With all the Latest Improvements as exclusively used by Mr. David Devant, of Egyptian Hall, London.

---

## CAMERAS

For taking Animated Photographs.

Special

Films

Taken.

ALL

ACCESSORIES

STOCKED.

Customers'

Films

Developed

and Printed.

P. W. Machines are  
recognised the Best in the  
Market.

---

CALL TO INSPECT BEFORE BUYING.

Telegraphic Address : "INFILMED."



# PHILIPP WOLFF,

Street, Holborn,

London.

PARIS.

## FILMS.

SUITABLE SUBJECTS

For all Seasons of the Year and for Everybody.

Humorous	}	Subjects.
Historical		
Sensational		

**SOUDANESE CAMPAIGN.**

Illusionary Films.

~~~~~

**Blank Films of all lengths supplied  
at Shortest Notice.**

SHOWS OF  
ANIMATED PHOTOGRAPHS SUPPLIED.

Telegraphic Address : "INFILMED."

THE PHOTOGRAPHER'S JOURNAL.



Science Siftings

*A Chatty Journal of*

PHOTOGRAPHY.

INVENTION,

FOOD,

HEALTH, and

SOCIOLOGY.



~~~~~  
**ONE PENNY WEEKLY.**  
~~~~~

*Editorial and Publishing Offices:*

123, 124, & 125, Fleet Street, London.

=====

SPECIMEN ON APPLICATION.

# Food Frauds and Foods that Feed.

BEING AN EXPOSURE ON

SOME COMMERCIAL SHAMS,

AND SOME ADVICE ON

WHAT TO EAT, ETC.,

**1s.**

BY

**1s.**

CHARLES HYATT-WOOLF,

*Editor of "Science Siftings,"*

*"The Optician and Photographic Trades Review,"  
etc.,*

GUTENBERG PRESS LTD., 123, 124, and 125, Fleet  
Street, London.

**Inefficient, Intricate, and High-priced Kine-  
matographs have hitherto prevented the  
popularisation of Animated Photography.**

**All these objections are removed by**

# **THE MICROGRAPH**

---

---



Mechanism, Lens, Con-  
denser, & well-finished  
Russian Iron Lantern  
Box, mounted on Wal-  
nut Baseboard. Com-  
plete:

**Price £6 6s.**

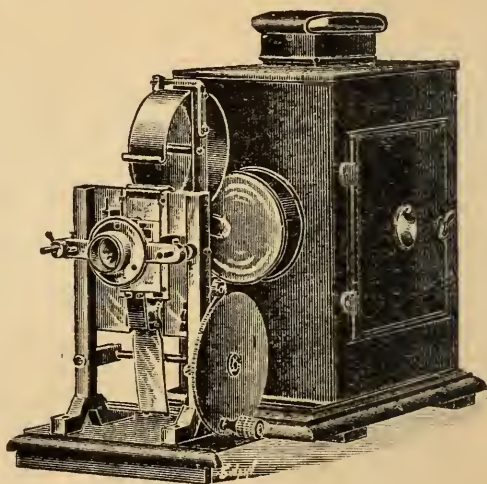

The Micrograph is so Accurately Adjusted as to satisfy the most exacting professional user ; it is so simple to manipulate, and so low in price as to make the projection of Animated Photographs

**A PASTIME FOR EVERY AMATEUR.**

---

*Large Stock of Films, Arc Lamps and all Accessories.*

---

**THE MICROGRAPH COMPANY, LIMITED,**  
**7, Great Queen Street, LONDON, W.C.**

Telegrams : " MICROGRAPH, LONDON."







Lenses for



PLEASE DO NOT REMOVE  
CARDS OR SLIPS FROM THIS POCKET

UNIVERSITY OF TORONTO LIBRARY

TR  
850  
H6  
1899

Hopwood, Henry V  
Living pictures

Engin

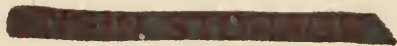

illy  
:he  
ed,  
cal  
lm  
ng  
int

'  
ng

o  
6  
o  
6

o  
o

o  
o  
6  
6

,

UTL AT DOWNSVIEW



D RANGE BAY SHLF POS ITEM C  
39 13 13 14 09 001 8