

## Geotechnical Instrumentation News

### **Publisher's Note:**

The principal publishing objectives of Geotechnical News are to provide general news on the activities of the geotechnical community in North America as well as a forum for technical information that may not meet the requirements of a refereed paper in the journals. Editors from the Canadian and US Societies provide the news of members' activities. Engineers who follow the ethic and commitment of a professional by sharing their knowledge and experience with their colleagues provide the technical articles in the GIN, Environmental Geotechnics and Geospec sections of Geotechnical News.

The principal articles in this issue have been collected by John Dunnicliff, the deeply committed editor of GIN. John has been the volunteer editor of GIN for over five years. Under his dedicated leadership, GIN provides diverse but discriminating reporting on the successful and unsuccessful performance of geotechnical instrumentation.

In the past 40 years technological advances have allowed the manufacture and use of sophisticated instruments by which we can now measure the performance of engineering structures. As part of the growing interest in environmental performance of man-made structures, society expects engineers to predict the long-term performance of many of these structures. The desire is that we do not pass on liabilities (technical) to future generations. Future performance depends to a great extent on monitoring the performance of existing structures. For this it is essential not only to use the appropriate geotechnical instrumentation but also to monitor, review and evaluate the data. Learning from the experience of others enhances our knowledge.

We thank John Dunnicliff and his fellow professionals who have taken the time to share their experience for the betterment of our chosen profession and who support one of the founding objectives of Geotechnical News.

*John Gadsby, Publisher*

## Instrumentation

**John Dunnicliff**

### **Introduction**

This is the twenty-second episode of GIN.

Because this issue of *Geotechnical News* has been designated as a special edition on instrumentation and because of John Gadsby's kind words above, I thought that I would begin this column by re-stating my objectives and pleas.

In the first episode of GIN (*Geotechnical News, Vol. 1, No. 3, September 1994, page 70*) I wrote:

*This is the first episode of what may become an ongoing saga in Geotechnical News. Its purpose is to share useful information relating to geotechnical instrumenta-*

*tion. I intend to focus on performance of instruments. As a practitioner, I know how difficult it is to be confident that such-and-such an instrument will work well, and it seems to me that if we share performance information with each other, we will make this less difficult.*

I pleaded for contributions to the 'column', and for articles.

Looking back more than five years later, I believe that the original objective is still valid. I've been particularly pleased with your contributions that tell about new technologies, and I hope that this will continue. I am the opposite of

pleased at the discovery of the effort needed for arm-twisting, and the major need for editing. Perhaps I should revise my expectations - as my wife tells me, blessed are they who expect nothing, for they shall not be disappointed! Please continue to send contributions - as I've said before, this is not "my section of Geotechnical News" it is "ours".

### **Temperature Sensitivity of Earth Pressure Cells**

The article by Barrie Sellers is a welcome example of a reader of GIN picking up the ball that I tossed out, and sending it back with a package of useful follow-up information. I wish more of you would do this, and I've said rather often "if any reader has experience with this, I'd welcome hearing about it". I've also said on several occasions that I very

much want this communication via GIN to be a two-way street. For example, does anyone have any information to help answer the question raised in the December 1999 issue of GIN (page 34): "at what organic content does generation of gas cause a measurement problem, such that we should opt for the more expensive piezometers with high air entry filters?"

**Instrumentation of Tunnels**

The article by Helmut Bock is based on the handout that he prepared for his presentation during the instrumentation course "on the beach" in Florida last November. I'd asked him to come to the course because I knew that the state-of-the-practice for monitoring tunnels in Europe is very different from that in North America, and hoped that we could all learn from the sharing of experience. Also, because Helmut used to be president of Interfels GmbH in Germany, a geotechnical instrumentation company that 'sells data' (i.e. hardware together with field and office services) rather than the typical North American practice of selling hardware only, I believed that he has many things to teach us. I hope you will agree that the article is a valuable contribution. It even includes a list of companies who supply the various instruments that are referred to in the article, together with e-mail addresses! As indicated in the preface, this article is Part 1 only - Part 2 will be in the June 2000 issue of GIN.

**Fiber Optic Sensors**

I always welcome articles about new measurement technologies, and several have appeared in previous issues of GIN. The following article by Choquet et al is in this category, and discusses fiber optic sensors. There have been two previous articles about fiber optic sensors in GIN (Tsang and England, GIN-6, December 1995, pp. 36-39 and Idriss et al, GIN-11, June 1997, pp. 43-45). You may have noticed from those two articles that there are several different sensing systems, including Fabry-Perot (no, this has nothing to do with a businessman/politician who made the classic remark "I'm all ears") and Bragg Grating. Both are defined by Tsang and England.

Idriss et al focus on Bragg Grating sensors, while Choquet et al focus on Fabry-Perot sensors.

The Office of Infrastructure R&D, US Department of Transportation, Federal Highway Administration is currently conducting a research program relating to the use of fiber optic gages for monitoring highway pavements and bridges, focussing on Bragg Grating sensors. I'm trying to convince the researchers to write an article for GIN, at which time either they or I will try to summarize comparative practical advantages and limitations of Fabry-Perot versus Bragg grating sensors - this is all pretty confusing to those of us in the geotechnical business! As I understand it now, many Bragg Grating sensors can be etched on to a single fiber, allowing for many measurement points, hence maximizing data quantity. However, each Fabry-Perot sensor requires its own fiber. So which gets the vote? - it depends on the application. You'll want to consider whether you feel comfortable with having all your eggs in one basket by risking damage to the one and only fiber.

**Vibrating Wire Settlement Cells - a Better Way to Go**

The contribution by John McRae has a self-explanatory introduction, and follows up on the article "Fluctuating Readings of Vibrating Wire Earth Pressure Cells" and associated discussions that were in the December 1999 issue of GIN. Another welcome example of a reader responding to one of my pleas for more information! The alternative technique described in the contribution appears to solve the problems addressed in the article and discussions.

**Piezometer Seals**

While in USA last November for the instrumentation course in Florida, I tried to update myself on the best materials for sealing piezometers in boreholes, by contacting suppliers and discussing with users. As recommended in GIN-15 (June 1998, page 42) it still seems to me that the best bentonite material for installation immediately over the sand zone is granular bentonite (not those

infuriating compressed bentonite pellets, which get sticky far too soon and become stuck too high in the borehole), either *Enviroplug Medium* (Wyo-Ben, Inc., P.O. Box 1979, Billings, MT 59103, tel: 800-548-7055 or 406-652-6351, fax: 406-656-0748, email: email@wyoben.com) or *Holeplug*, 3/8 inch size (Baroid Industrial Drilling Products, 3000 North Sam Houston Parkway East, Houston TX 77032

# GEONOR

---

**GEOTECHNICAL INSTRUMENTATION & DATA ACQUISITION**

- Dams
- Embankments
- Slopes
- Tunnels
- Structures
- Excavations

---

**IN SITU TEST APPARATUS**

- Field Vane Shear Apparatus
- Cone Penetration Test (CPT) Equipment
- Vibration Monitoring Equipment

---

**GEONOR, INC.**  
 Milford, PA 18337 USA  
 Tel: 1-570-296-4884  
 Fax: 1-570-296-4886  
 E-mail: geonor@geonor.com

---

**GEONOR A/S**  
 Oslo Norway  
 Tel: 47-67 14 75 50  
 Fax: 47-67 14 58 46  
 E-mail: ok@geonor.no

---

www.geonor.com

tel: 800-735-6075 or 281-871-5645,  
 fax: 281-871-4621, email:  
 idp@baroid.com,  
 web-site: <http://www.baroididp.com>).

I had previously recommended Ben-seal/EZ-Mud Slurry (Baroid) for a soft consistency and low permeability grout above the granular bentonite, but now acknowledge that this is probably not the best choice, because it requires mixing two components and water. Technical people at the above two manufacturers both recommended single-component grouts for this purpose - Baroid's EZ SEAL and Wyo-Ben's Enviroplug Grout. Both manufacturers supplied samples of the hydrated products for us to poke with our fingers in Florida, and both appeared to be suitable. They also supplied samples of the dry product, with mixing instructions and equipment, which we played with in a group. Both set up much too quickly (on my tie too!), such that we were all left in doubt. One of the course attendees is planning to make some more appropriate field tests, so that we hope to be able to make a firm recommendation in a later issue of GIN. Watch this space! **If any reader has any experience with this, I'd welcome hearing about it.** Have you heard that before?

**Piezometers with High Air Entry Filters**

While at the recent Symposium on Field Measurements in Geomechanics (FMGM-99) in Singapore I learned that some, perhaps many, procurement specifications for pneumatic and vibrating wire piezometers call for high air entry filters. This was presumed to be because 'high air entry' seems to imply a higher quality. In fact, in the normal application of measuring pore water pressure in saturated soils, use of high air entry filters is likely to result in incorrect data. For those interested in this topic, rather than attempt to give the explanation here, you'll find it in the red book Sections 9.11 through 9.15 (pages 141-148). The application for high air entry filters is limited to the need to measure pore **water** pressure in unsaturated soils, in which case the filter and cavity between filter and diaphragm must be **fully** saturated with de-aired water and the outside of the filter must be in intimate contact with the soil to ensure hydraulic continuity.

**My E-mail Address**

Near the end of the previous GIN I gave my new e-mail address as: johndunni-

cliff@attglobal.com. This is **wrong!** Thank you to those of you who have pointed this out. The correct address is: [johndunnicliff@attglobal.net](mailto:johndunnicliff@attglobal.net). Perhaps the lesson is not to proof-read on the screen!

**The Millennium**

Was I the only one who suffered the Y2K bug? A major crash as the millennium reached the Middle East. Huge frustration. Nearly a week to fix. A new hard drive. Loss of some files. Most standard settings changed. Perhaps I should go back to a slate, chalk and an abacus. And to cap it all, just as the millennium reached its end in Samoa, a thick opaque mist arrived to blot out the sun. Both the bug **and** the world coming to an end?

**Closure**

Please send contributions to this column, responses to the balls that I have tossed out, or an article for GIN, to me as an e-mail attachment in ms-word (address as above, remembering the 'net' at the end) or by fax or mail: *Little Leat, Whisselwell, Bovey Tracey, Devon TQ13 9LA, England. Tel. +44-1626-836161, fax +44-1626-832919. Kia-ora! (Maori, New Zealand).*

**Re: Temperature Effects on Earth Pressure and Concrete Stress Cells**

**Editor's Note:**

In the June 1997 issue of Geotechnical News (GIN-11), I wrote the following, under the heading 'Temperature Sensitivity of Earth Pressure Cells'

*We should all know that, if we fill a somewhat rigid container with liquid, then warm up the container, the liquid will expand and generally its pressure will increase. Now think of a hydraulic earth pressure cell, with a tube connecting the liquid to a pressure transducer. Temperature sensitive? Yes.*

*Most manufacturers provide a temperature calibration for the transducer, and a temperature sensor within the transducer. But what about a temperature calibration for the cell itself? Can't do. When temperature changes at an installed earth pressure cell, the "correction" depends on the extent of the restraint given to the cell by its surroundings. Sure, we could develop a cell cali-*

*bration by immersing the cell in water at various temperatures, but this doesn't model field conditions correctly, because during the calibration there's no restraint.*

*In a full-embedment installation, where cells are embedded within fills, this issue is rarely important, because the cells are usually below the zone of temperature change. However, if contact earth pressure cells are exposed to changing ambient temperature, such as at the faces of mechanically stabilized earth walls, soil-nailed walls and other types of retaining walls, data accuracy can be severely downgraded, and there doesn't appear to be a viable method for temperature correction.*

*If any reader has experience with this, I'd welcome hearing about it.*

Barrie Sellers has responded with the following article. Having read and learned from this article, I accept that I overstated the problem by using the word "severely".

*John Dunnicliff*

## Temperature Effects on Earth Pressure and Concrete Stress Cells Some Theoretical Considerations

**Barrie Sellers**

The following theoretical treatment is by no means rigorous - there are some questionable assumptions and approximations — but it should give some idea of the magnitude of the thermal effect to be expected on hydraulic earth pressure cells, buried in soil, or installed at the contact between soil and structure, and on concrete stress cells embedded in concrete.

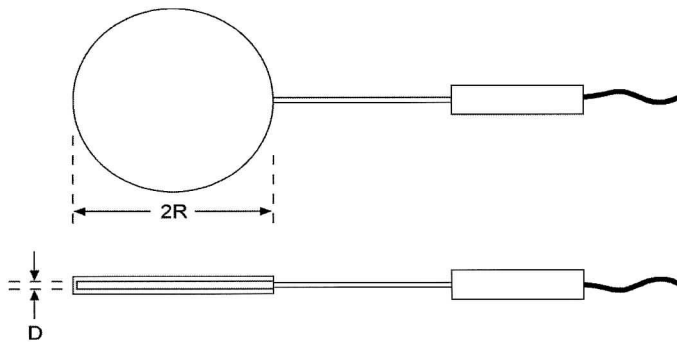

Consider a circular cell of radius R containing a liquid film of thickness D, coefficient of thermal expansion  $K_{ppm/°C}$ , and bulk modulus G.

For a temperature rise of  $1° C$  the expansion,  $Y_T$  of the liquid film is given by the equation:

$$Y_T = KD$$

Expansion of the liquid is resisted by the confinement of the surrounding medium (soil or concrete) and this causes a pressure rise, P, in the liquid and a compression of the liquid,  $Y_c$ , given by the equation:

$$Y_c = PD/G$$

So that the net expansion, Y, of the cell is equal to:

$$Y = D (K - P/G)$$

Liquid pressure inside the cell causes deformation of the surrounding medium. The amount of deformation can be quantified by modification of formulas found in Ref 1, where the deformation, Y, produced by a uniform pressure, P, acting on a circular area, R radius, on the surface of a material with modulus of elasticity, E, and Poissons ratio,  $\nu$ , is given by:

$$Y = \frac{2PR(1-\nu^2)}{E} \quad \text{at the center}$$

And

$$Y = \frac{4PR(1-\nu^2)}{\pi E} \quad \text{at the edge}$$

And the difference is

$$\frac{PR(1-\nu^2)}{E} (2 - 4/\pi)$$

The above formulas apply to pressures acting on a free surface. However, in the confined case, Y, at the edge of the cell, can be assumed to be nearly zero and so Y, at the center, is assumed to be:

$$\frac{PR(1-\nu^2)}{E} (2 - 4/\pi)$$

i.e. the same difference as before.

If the average Y, across the cell is assumed to be half this value and if the deformation of the medium on either side of the cell is assumed to be the same then the average total expansion of the cell is given by:

$$Y = 0.73 \frac{PR(1-\nu^2)}{E} \times 0.5 \times 2 = \frac{0.73PR(1-\nu^2)}{E}$$

Equating gives:

$$P [D/G + 0.73 R (1-\nu^2)/E] = KD$$



Some typical values of the various parameters are:

Liquid	K x 10 <sup>-6</sup> /°C	G x 10 <sup>6</sup> /°C
Oil	700	0.3
Mercury	180	3.6
Water	170	0.3
Glycol	650	
50/50 Glycol/Water	400	

Embedment Material	E x 10 <sup>6</sup> psi	ν
Plastic Clay	0.003	
Soil	0.001 to 0.02 [Ref 2]	0.25 to 0.45
Sand	0.02 to 0.06 [Ref3]	0.28 to 0.35
Compacted Ottawa Sand	0.2	
Concrete	5.0	0.25

If one side of the cell lies in contact with a rigid structure, e.g. a concrete retaining wall or a concrete bridge footing, then

$$Y = 0.73 \frac{PR(1-\nu^2)}{E} \times 0.5 = 0.36 \frac{PR(1-\nu^2)}{E}$$

And

$$P [D/G + 0.36 R (1-\nu^2)/E] = KD$$

Where E pertains to the soil material.

### Examples

For an oil-filled cell, 9 inches diameter and D = 0.020 inches, totally embedded in:

- 1. Plastic clay, E = 3000 psi, ν = 0.3 P = 0.014 psi/°C
- 2. Soil, Medium stiffness E = 10000 psi, ν = 0.3 P = 0.046 psi/°C
- 3. Coarse sand, E = 50000 psi, ν = 0.3 P = 0.23 psi/°C

(For contact pressure cells, multiply the above values of P by 2.)

- 4. Concrete, E = 5 x 10<sup>6</sup> psi, ν = 0.25 P = 22.7 psi/°C

Same cell, embedded in concrete, filled with mercury instead of oil P = 5.8 psi/°C

For an oil-filled cell embedded in a completely rigid medium P = 210 psi/°C

For a mercury-filled cell embedded in a completely rigid medium P = 650 psi/°C

Since these expressions are only approximate they can be simplified even further: for all E < 10 x 10<sup>6</sup> psi the term D/G is negligible so long as the cell is designed and constructed properly, i.e., G is large, (no air trapped inside the cell), and D is small. Also, the term (1-ν<sup>2</sup>) can be replaced by 0.91 since ν usually lies between 0.25 and 0.35.

Hence, for total embedment:

$$P = 1.5 \text{EKD/R psi / } ^\circ\text{C}$$

And, for contact pressure cells:

$$P = 3 \text{EKD/R psi / } ^\circ\text{C}$$

### References

- [1] Roark, R.J. and Young, W.C. "Formulas for Stress and Strain," McGraw Hill, fifth edition, 1982, p 519.
- [2] Weiler, W.A. and Kulhawy, F.H. "Factors Affecting Stress Cell Measurement in Soil" J. Geotech. Eng. Div. ASCE. Vol. 108, No. GT12, Dec., pp1529-1548.
- [3] Lazebnik, G.E., "Monitoring of Soil-Structure Interaction." Chapman & Hall. pp 224

Barrie Sellers, President, Geokon Inc.,  
48 Spencer Street, Lebanon, NH 03766,  
USA Tel. (603) 448-1562  
Fax (603) 448-3216  
E-mail: Barrie@geokon.com

## Geotechnical Instrumentation of Tunnels with Particular Reference to European Practices

Helmut Bock

### Preface

It is common practice to monitor the performance of tunnels during and after construction. Monitoring is carried out by combined geodetic and geotechnical instrumentation and monitoring methods.

Traditionally, the objective of monitoring is verification of the tunnel design. Key physical parameters are measured and compared with predicted values. In case of significant deviations an adjustment of the tunnel design may be indicated. Beyond this, geotechnical instrumentation may also

be used in the quality assessment of certain tunnel construction procedures. In critical situations (e.g. tunnelling beneath settlement-sensitive structures in inner-city areas) it can yield construction control signals for the entire tunneling operation.

Part 1 of this contribution gives an account of recent European developments and practices in performance monitoring for tunnel design purposes. A separate Part 2, to be published in the June 2000 GIN issue, focuses on geotechnical instrumentation to assist with construction control.

# Geotechnical Instrumentation of Tunnels with Particular Reference to European Practices

## Part 1: Performance Monitoring for Tunnel Design Verification

**Helmut Bock**

### 1. Introduction

In underground construction, geotechnical instrumentation is used for purposes which are summarised in Table 1.

For evaluation of the tunnel design, a set of elementary tunnelling instrumentation is commonly employed which is set out in Figure 1.

The discussion of the instrumentation shown in Figure 1 (together with some selected additional instrumentation) will be in accordance with the common engineering purpose which can be classified as follows:

- Instrumentation for an *empirical proof of a new equilibrium* after tunnel excavation: Convergence and/or geodetic deformation monitoring (Section 2).
- Instrumentation for the monitoring of displacements and stresses to compare measured and predicted values for *evaluation and improvement of the tunnel design* (Section 3).

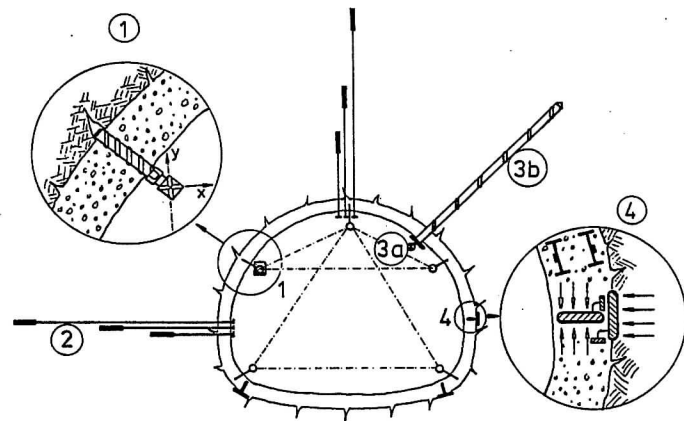

No.	Measuring objective	Instrument
①	Deformation of the excavated tunnel surface	Convergence tape Surveying marks
②	Deformation of the ground surrounding the tunnel	Extensometer
③	Monitoring of ground support element "anchor"	a. Total anchor force b. Measuring anchor
④	Monitoring of ground support element "shotcrete shell"	Pressure cells Embedment gauge

Figure 1. Elementary tunnelling instrumentation (out of Interfels catalogue).

No	Purpose	Example	Suitable Instruments	Part
1	Empirical proof of a new equilibrium after tunnel excavation	Convergence measurements Surveying methods	Tape extensometer Total station	1
2	Comparison between measured and predicted values for an improved tunnel design	Displacement measurements in the ground surrounding the tunnel. Stress monitoring of shotcrete lining	Borehole extensometer and inclinometer. Total pressure cell (TPC). Flat jack compensation.	1
3	Quality control of selected tunnel construction procedures	Excavation profile of tunnel. Direction control of drillholes in freezing tunnel	Tunnel scanner. Deflectometer.	2
4	Control of entire tunnelling operations	Soilfrac® and real-time settlement monitoring in inner-city tunnelling	Multi-point liquid levelling system. Electrolevel gages. Motorised digital level.	2

Table 1. Application of geotechnical instrumentation in underground construction.

Accuracy Class	Measuring principle Essential Construction Features	(Manufacturer)	Resolution [mm]	System Accuracy [mm]
I	Convergence tape with invar wire Coupling: Universal joint. Bolts with measuring stop.	(SolExperts AG).	0,001	± 0,003
II	Convergence tap with steel tape Coupling: Universal joint. Bolts with measuring stop.	(Interfels GmbH)	0,01	± 0,05
III	Convergence tap with steel tape Coupling: Eyebolt-hook connection.	(North American manufacturers)	0,05	± 0,5
IV	Geodetic tunnel surveying Total station (tachymeter) with integrated coaxial distance measurement	(e.g. Leica)	1	± 2 to 3
V	Tunnel Scanner	(ref to Part 2)	appr. 1	appr. ± 10

Table 2. Instruments and methods for convergence measurements in tunnelling

**2. Instrumentation for an Empirical Proof of a New Equilibrium after Tunnel Excavation: Convergence Tape Measurements and Surveying Methods**

Convergence measurements and monitoring of the displacements of the excavated tunnel surface by surveying methods are part of the routine operations in today's tunnel construction. In essence, the change of the displacements is monitored and correlated with tunnel construction procedures such as excavation, installation of the ground support and closure of the invert. "Stabilisation of the entire system and its safety, the necessity of additional support and, in reverse, the permissibility of reducing the support system is judged on the basis of convergence or displacement measurements at or near the excavated tunnel surface" (Leopold Müller, 1978; p. 607).

**2.1 Convergence Tapes (Tape Extensometers)**

For convergence measurements, the distance between two points on the excavated tunnel surface is measured by specially manufactured tapes (so-called "convergence tapes" or "tape extensometers"). A common technical feature of such tapes is the high reproducibility of their tensioning force in a measuring position. The measuring points are defined by convergence bolts which are attached to the linings, e.g. placed in the shotcrete in a manner that their measur-

ing heads are pointing towards the excavation and remain accessible throughout the lifetime of the monitoring project. After installation of the bolts, a first round of reference (or "zero") convergence measurements is carried out. By way of follow-up measurements (and subtraction of the measured values from the respective values of the zero measurement) the change of the distance between the bolts can be determined.

The accuracy of convergence meas-

urements is in the range of 0.003 to 0.1 mm and depends on a number of factors, amongst them the type of instrument, the material of the tape and the type of coupling of the tape to the bolts (ref. to Table 2). Note that convergence measurements are generally more accurate than geodetic displacement measurements (ref. to Table 2 and Section 2.2).

In today's European tunnelling practice, convergence tapes are hardly used anymore. Instead, geodetic monitoring

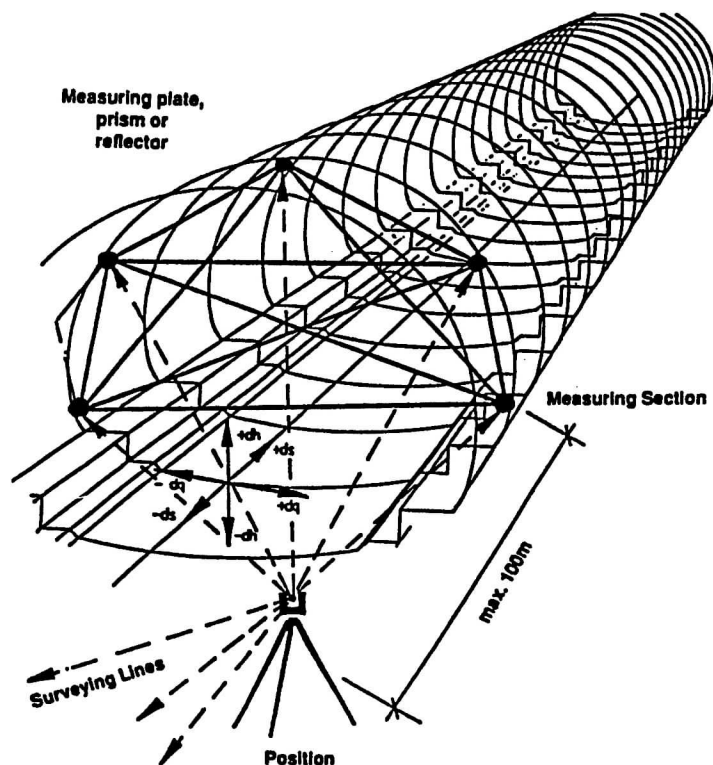

Figure 2. Principal sketch of a geodetic deformation monitoring set-up in tunnelling (Intermetric catalogue).

is quasi-standard and has substituted tape measurements almost entirely. This is despite the lower system accuracy of the geodetic method. Only in special or sensitive projects (e.g. underground research laboratories; nuclear repositories) are convergence tapes still in use. Generally in these applications, tapes of the Accuracy Class I or II (ref. Table 2) are employed.

The main reason for the substitution of convergence tape measurements by geodetic deformation monitoring is associated with the following principal disadvantages of convergence tape measurements:

- 1 high degree of interference with tunnelling operations
- 2 no realistic perspectives for automation
- 3 restricted to *relative* displacement measurements.

**2.2 Geodetic Deformation Monitoring**

In European tunnelling practice today, *geodetic monitoring represents the real backbone of tunnel performance monitoring* in terms of volume of work and

turnover figures.

As indicated in Figure 2, displacement measuring sections are routinely installed every 10 to 25 m along the tunnel axis. Commonly, each section consists of five reflector targets (Figure 3) which are equally spaced along the tunnel periphery. This set-up is modified in partial tunnel excavations (Figure 4). The targets are surveyed, up to a distance of maximally 100 m, by precision total stations with automatic data acquisition. Each set of readings consists of two angles and one distance measurement. Total stations can be freely positioned to minimise interference with the tunnelling operations. Recent developments include motorised instruments with automatic target recognition. Such instruments can be temporarily or permanently positioned at the tunnel sidewall and can be operated by non-specialists.

The results of geodetic tunnel deformation measurements are usually presented graphically. One standard graph is that of the displacement of the 5 measuring points in a cross section as depicted in Figure 5. Note that *absolute*

*displacements* were determined and graphed. The relative displacements between any two measuring points (= "convergence" in the narrow sense) is then simply calculated by subtraction between the two displacement values.

Much emphasis is currently given to the *integration of geodetic tunnelling surveying with traditional geotechnical monitoring*. The key to this approach is a suitable, integrated acquisition and evaluation software. Geotechnical instrumentation companies, which have the leading edge in this regard, are GeoData of Austria with its ITMS (Integrated Tunnelling Measuring System), SolExperts of Switzerland with its GeoMonitor System and Sol Data of France (for company addresses ref. to Appendix 1). Similarly, some traditional surveying companies are also moving towards such an integrated approach by establishing special geotechnical instrumentation units. An example is Intermetric GmbH, a Stuttgart-based surveying company, which has specialised in integrated geotechnical / geodetic monitoring services for tunnelling. Recently, Intermetric has released its

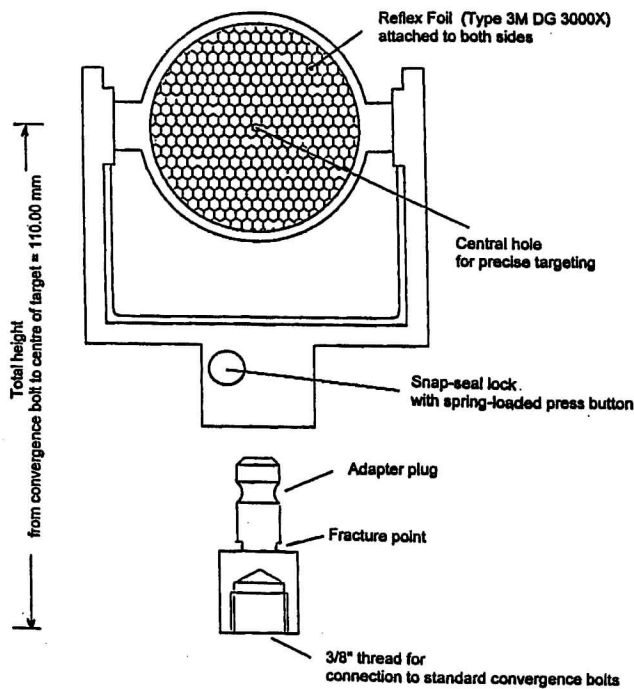

Figure 3. Reflector targets for geodetic deformation measurements in tunnels (Interfels catalogue).

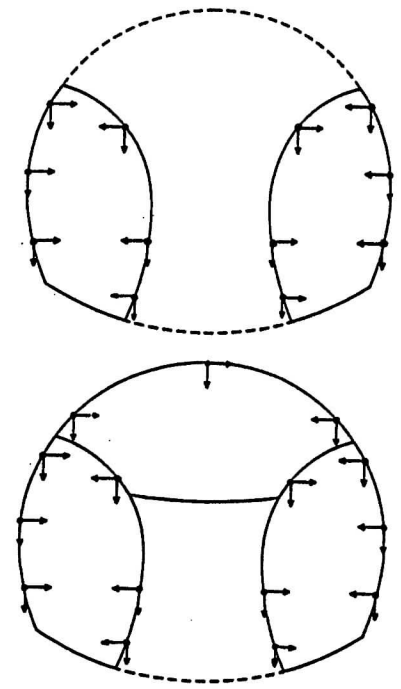

Figure 4. Common layout of targets for geodetic deformation measurement in partial tunnel excavations - © IUB.



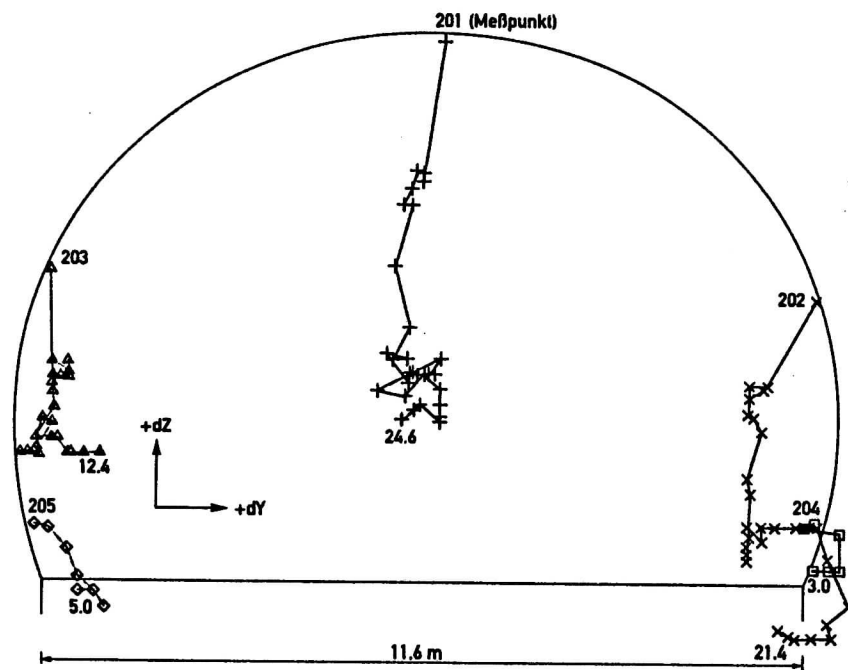

Figure 5. Example of a geodetic deformation measurement in tunnelling. Presentation of the absolute displacements of the 5 targets (in millimetres) for various time steps.

Software System “iGM” (intermetric Geotechnique Monitor). iGM is an automatic data acquisition and evaluation program for up to 500 sensors in a measuring network. iGM can manage data from motorised digital levels, motorised total stations (tachymeters) and all types of geotechnical instruments including extensometers, inclinometers, level gauges, temperature gauges, vibrating wire sensors, total pressure cells and strain gauges.

### 2.3 Engineering Assessment of Convergence and Geodetic Deformation Measurements

Apart from the graph in Figure 5, the measuring results of the convergence tape or geodetic deformation measurements are typically graphed as time-displacement curves, presented in Figure 6. Essential for the assessment of such measurements is a synoptic presentation of the tunnel construction work with the time-displacement curve.

The main criterion for the engineering assessment of the measuring results is simply the question of whether or not the convergence movements have come to a halt. If positive, the time-displace-

ment curve will tend to converge towards a horizontal line. This is taken as proof that the tunnel system, consisting of the surrounding ground and the various support materials, has found a new equilibrium. If negative, the actual time-displacement curve would be inclined, perhaps even weeks or months after completion of the last tunnel construction procedure. The base of this engineering approach therefore is the consideration of the *deformation velocity* (and of the deformation acceleration). The *absolute magnitude of the deformation* is not considered in this regard.

The common interpretation of convergence and geodetic deformation measurements therefore remains at a rather *empirical level*. It does not yield any in-depth insight into the mechanics of a tunnel system. In particular, it does not provide any information on the actual safety margin of the tunnel and its linings.

### 2.4 Load Bearing Capacity Reserves and Safety Factors of Shotcrete Linings As Deduced from Geodetic Deformation Measurements

Efforts to correct the above-mentioned situation are currently being undertaken by Rokahr and co-workers of the University of Hanover. These include extensive on-site testing at a number of Austrian and German tunnelling projects. Rokahr also points to the fact that the common empirical interpretation of convergence and geodetic deformation measurements does not yield any clear evidence on the actual load bearing capacity of a shotcrete tunnel. On the basis of such measurements alone, it would not be possible to specify any factor of safety against failure of the tunnel construction and its lining.

In realising that the stress-strain relationship of shotcrete is highly time-dependent, Rokahr claims that science has advanced to the stage where this relationship can be specified with a sufficient degree of accuracy and confidence. Employing numerical modelling procedures he converts the measured strain of the shotcrete lining (as deduced from the displacement measurements) into stresses. On the basis of this information, it is then possible to specify the actual degree of loading, the load bearing capacity and the actual factor of safety of the shotcrete lining.

Figure 7 shows an example for a 925 m long shotcrete tunnel section. It indicates that, whilst subject to significant local fluctuations, the capacity of the shotcrete lining (i.e. the actual load divided by the load bearing capacity) was maximally occupied to about a level of 50 to 80%. This is equivalent to a factor of safety against failure of the shotcrete lining of between 1.25 and 2.0.

The derivation of the load bearing capacity of the shotcrete lining is based on a number of steps as indicated in Figure 8. Each step is intrinsically associated with assumptions and errors. It is therefore highly desirable to check the end result (i.e. the computed stresses acting in the lining) by direct measurement. Recently this has been done by employing the *Slot Relief & Flat Jack Compensation Method*. This method

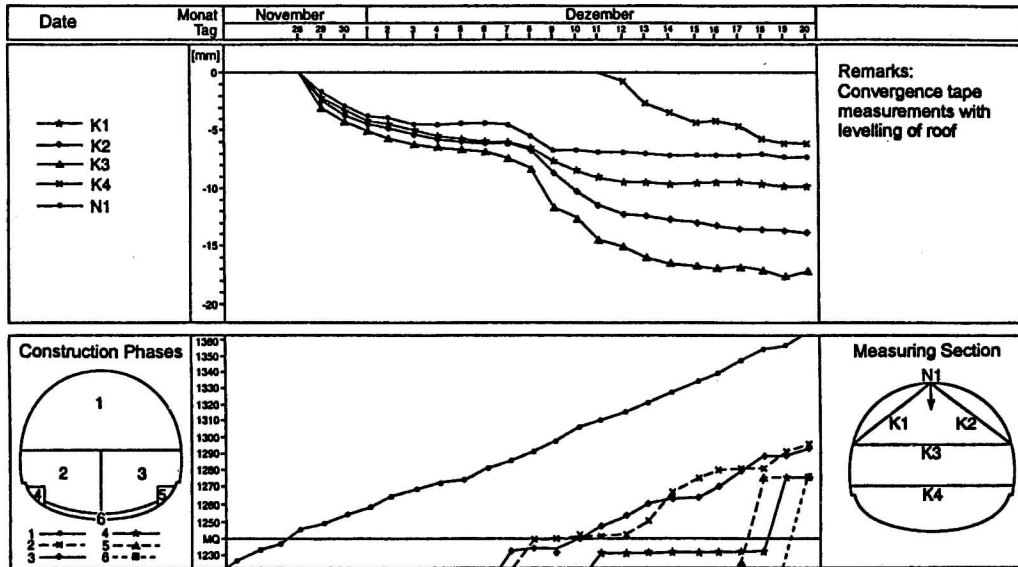

Figure 6. Graphical presentation of conventional convergence tape measurement (top) in a time versus relative displacement diagram. Note: Influence of tunnelling operations (bottom) on convergence.

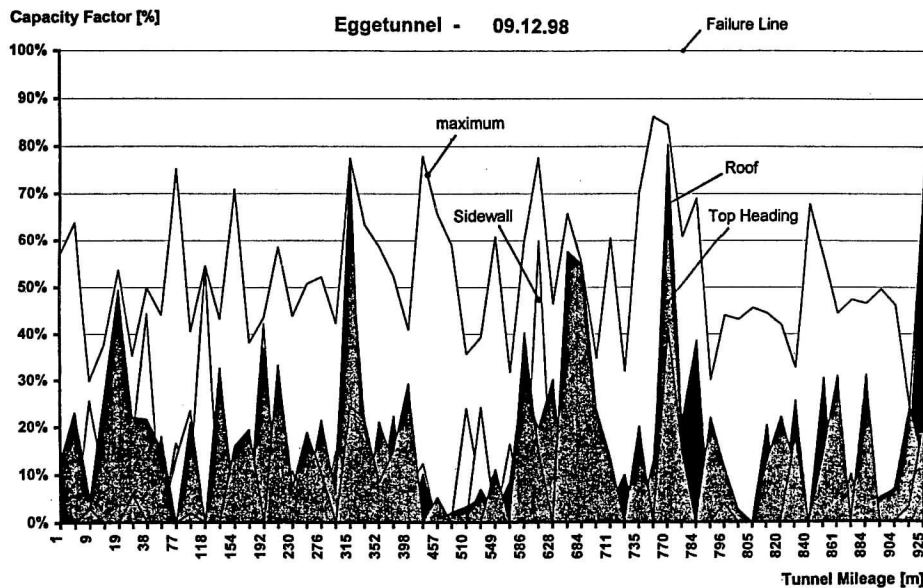

Figure 7. Capacity factor of a shotcrete lining of a 925 m long tunnel section (Egge railway tunnel - NW section, currently under construction; after Rokahr, 1999).

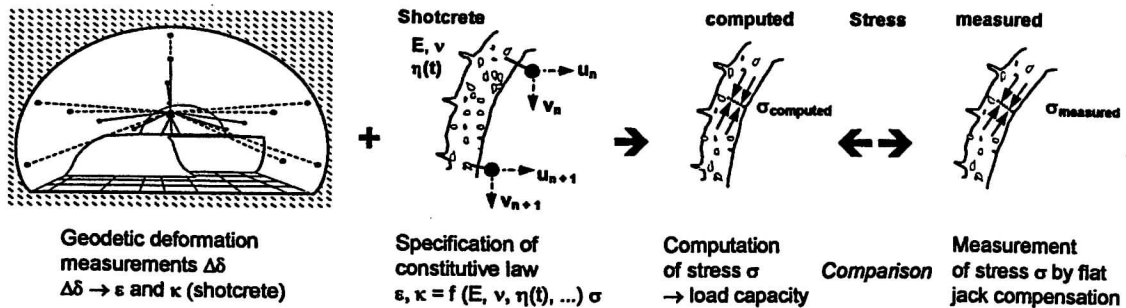

Figure 8. Evaluation and checking procedures of the load bearing capacity determination of shotcrete linings based on geodetic deformation monitoring and stress measurements by the slot cutting and flat jack compensation method.

has a proven record of reliability and, in the author's opinion, is the best method for stress determination of concrete and similar materials at accessible surfaces. The slot relief and flat jack compensation method is carried out in a sequence of three steps, as indicated in Figure 9. Firstly, measuring marks are set next to the intended cut (Figure 9a). Then the slot is cut by a diamond saw, typically 450 mm, and measurements taken on the convergence of the measuring marks due to slotting (Figure 9b). Finally, a flat jack, which conforms to the shape of the slot, is inserted into the slot and hydraulically inflated until the point of full reversal of the measured convergence (Figure 9c). The point is termed "compensation point". Accordingly, the pressure acting in the jack at the compensation point is termed "compensation pressure". This pressure is (nearly) equivalent with the stress in the shotcrete to be determined. Note that no knowledge of material parameters (such as the Young's modulus  $E$ ) is required for this test.

In the example of the tunnel project shown in Figure 7, the result of the comparison between computed stresses (as

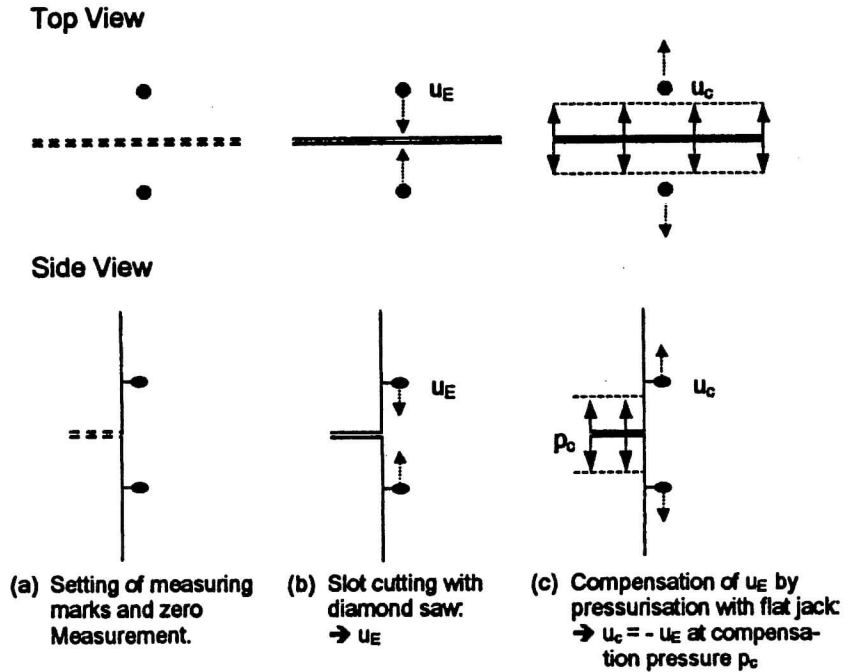

Figure 9. Measuring principle of the slot cutting and flat jack compensation method.

deduced from geodetic displacement measurements) and measured stresses (employing the flat jack compensation method) is shown in Figure 10. There is excellent agreement between the two

methods.

It is the expectation of the author that within the near future the evaluation of the capacity of shotcrete linings will become a widely applied standard in

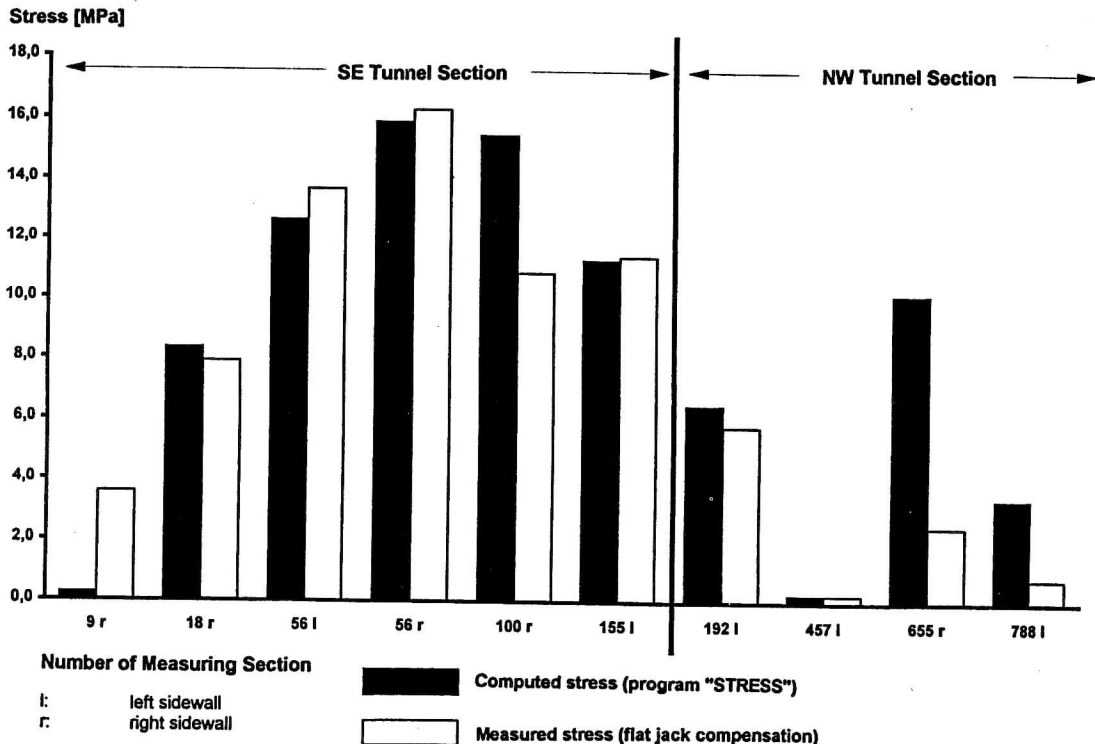
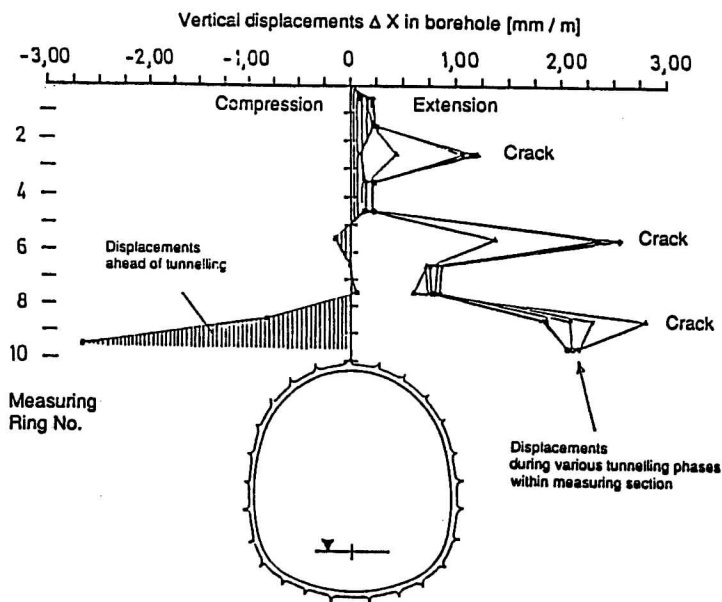

Figure 10. Comparison between computed and measured tangential stresses of the shotcrete lining of the Egge Tunnel (Rokahr, 1999).



**Measuring task:**

Evaluation and control of loosening of the tunnel roof strata

**Main results:**

- (1) Ahead of tunnelling (hatched in the graph) there is a state of compression at the tunnel face and in the roof strata
- (2) As soon as tunnelling has passed the measuring section, the characteristics of the ground deformation of the roof strata changes from compressive to extensional.
- (3) Clearly, the degree of extension is discontinuous. Local peaks were recorded at depths of 9.0 m; 7.0 m and 4.0 m (→ cracks). This is indicative of an onion-style loosening structure in the tunnel roof strata.
- (4) The four follow-on measurements, carried out during the various tunnel excavation phases, do not differ significantly. This is indicative that the tunnel system has found a new equilibrium after excavation.

Figure 11. Monitoring of the loosening of the roof strata of a near-surface railway tunnel by the probe extensometer "INCREX" (after Estermann, 1991).

tunnel construction. The base requirement for this will be extensive geodetic deformation monitoring, accompanied with regular checking of the computed stresses by the slot cutting and flat jack compensation method.

**3 Instruments for Monitoring of Displacements and Stresses for Better Design**

In the previous Section 2 it was already indicated that convergence and / or geodetic deformation measurements alone are insufficient for a full judgement as to the mechanical behaviour of the tunnel system.

Two reasons can be identified in this regard:

- The ground surrounding the tunnel is not directly monitored. This, however, is necessary as the ground has a definite load bearing capability and is one of the contributing factors in the overall stability of the tunnel system.
- A mechanical description of a tunnel system remains incomplete if it is solely based on displacements and its

derivatives. Knowledge of the forces (and stresses) are definitely required for completeness.

In a tunnel monitoring program which is specifically set up for control of the tunnel design, at least all of the standard instrumentation, as indicated in Figure 1, should be installed to provide a sufficiently broad data base for comparisons to be made between measurements and predictions.

This monitoring program consists of the following:

1. Deformation measurements of the excavated tunnel surface, as already described in Section 2.

*Instrumentation:*

Total stations and reflector targets (in special cases: convergence tape)

2. Deformation measurements of the ground surrounding the tunnel.

*Instrumentation:*

Borehole extensometer (especially 3-point extensometer)

Comment: Hardly used anymore in Europe as installation interferes with tunnelling operations. However, the situation is completely different in near-surface tunnelling (ref. to below).

3. Control of the ground support element "anchor" or "rock bolt".

*Instrumentation:*

3a. Anchor load cell → monitoring of the forces at the head of the anchor

3b. Measuring anchor → strain monitoring over the length of the anchor. This yields information on the required length of the anchor.

4. Control of the ground support element "shotcrete".

*Instrumentation:*

Total pressure cells (TPC) → passive hydraulic flat jacks for monitoring of the radial and tangential stresses.

Comment: In Europe, many tunnel engineers are somehow disenchanted with TPCs for shotcrete stress monitoring. Clearly, the performance of TPC is critically dependent on a number of factors, amongst them the TPC design, local conditions and, in particular, the quality of the installation. Some engineers prefer concrete embedment strain gauges instead of TPCs. This requires an in-depth knowledge of the time-dependent stress-strain relationship of the shotcrete (ref. also to the approach of Rokahr → Section 2.4).



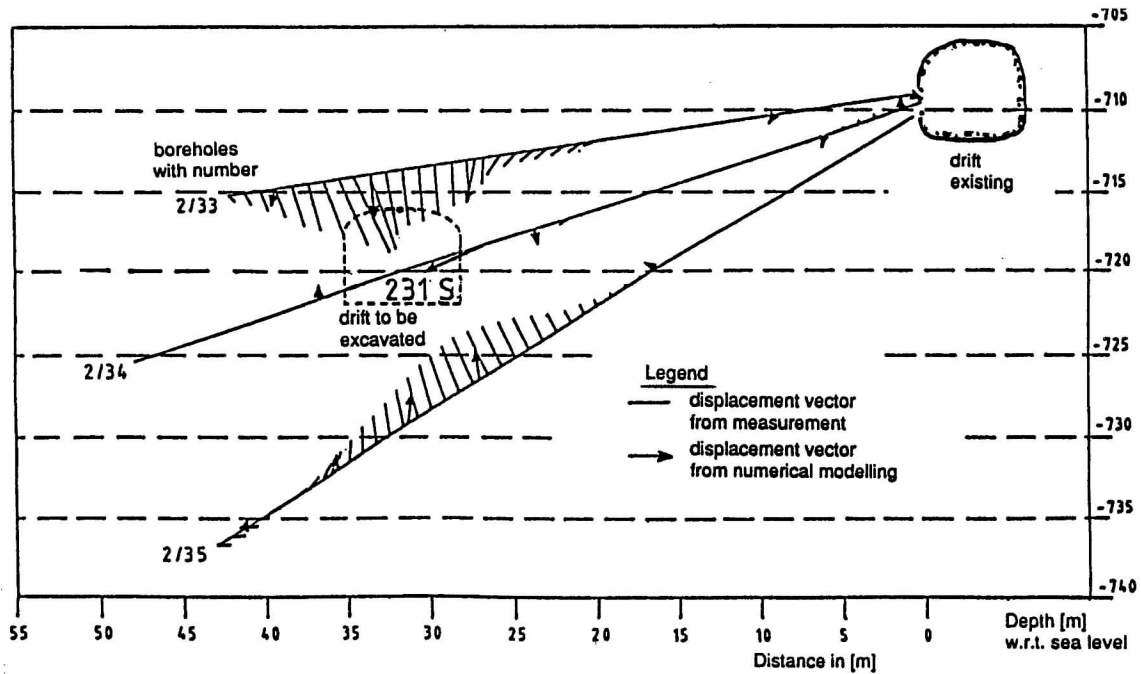

**Measuring task:** High-definition deformation measurements in the ground for comparison with predictions of Finite Element computations.

- Main results:**
- (1) Most detailed evaluation of the ground displacement state in the vicinity of the newly excavated drift as shown by displacement vectors. Note that each vector has an axial (determined by the probe extensometer INCREX) and a lateral component (determined by horizontal inclinometer) with regard to the borehole axis.
  - (2) All displacement vectors are oriented towards the new excavation (even in the invert strata).
  - (3) There is a reasonable degree of agreement between measured and predicted displacement values both with regard to direction and magnitude (→ indication that the geomechanical model is acceptable).

Figure 12. Ground displacements due to the excavation of a deep-seated tunnel as measured by the conjunctive use of probe extensometer and probe inclinometer (after Diekmann and Kern, 1991).

Ground Stress Measuring Method (Manufacturers)	Absolute $\sigma_1 \sigma_2 \sigma_3$	Change $\Delta \sigma$	Remarks Limitations	Development Potential
<b>Overcoring of a strain cell</b> CSIRO - Australia: "Hollow Inclusion Strain Cell" (Mindata P/L, Seaford, Vic.) CSIR - South Africa: 3-ax.strain cell	$\sigma_1 \sigma_2 \sigma_3$	(no)	World-wide in use Expensive; Limited number of tests	Mature method. No major further potential as above
<b>Hydraulic Fracturing</b> (numerous small companies)	$\sigma_1 \sigma_2$	no	World-wide in use limited for 2-D	medium
<b>Borehole Slotting Stressmeter</b> (Interfels)	$\sigma_1 \sigma_2$	limited	Numerous measurement. Momentarily restricted to 2-D and $t(\max) = 40m$ .	high
<b>Hydraulic Total Pressure Cells (TPCs)</b> installed in boreholes (Glötzl; Interfels)	no	yes	Suitable for soil, soft rock and rock salt	medium
<b>Hard Inclusion Cells (Vibrating Wire)</b> (Geokon; Irad Gage)	yes	yes	For hard rock only Requires overcoring	low to medium

Table 3. Methods for measuring and monitoring of ground stresses

5. Control of the ground support element "steel arches" (not indicated in Figure 1).

*Instrumentation:*

*Strain gauges and total pressure cells*

Comment: Not commonly used in Europe.

### 3.1 Instruments for Measurement of the Displacements of the Ground

In near-surface tunnelling, the above standard instrumentation will be modified accordingly. In particular, this applies to the measurement of the ground movements by borehole extensometers which are now installed from the ground surface and not, as previously, from within the tunnel excavation.

Extensometers which are installed from the ground surface offer the following advantages:

- No interference with tunnel construction operations (this is seen as the major advantage)
- Installation and measurements are not restricted to the post-excavation phase. All ground deformations can be monitored including those ahead of tunnelling which are of particular concern in inner-city tunnelling.
- Problem-free installation and convenient measuring operations with high-definition probe extensometers.

The measuring example of Figure 11 gives evidence of these advantages.

Borehole extensometer measure the particular component of ground displacements which is directed *along the axis* of the borehole. For monitoring the complete deformation state of the ground instruments must be employed, in addition to extensometers, which measure the displacement components acting *across* the borehole axis. This is achieved by standard inclinometers (in vertical boreholes) or by horizontal inclinometers or deflectometers (in inclined or horizontal boreholes), either stationary as fixed borehole chains or as mobile borehole probes.

Figure 12 shows a measuring example of a deep-seated tunnel in which the ground displacements were measured by the conjunctive use of mobile extensometer and inclinometer.

The measuring example of Figure 12 also indicates the intrinsic purpose of this type of monitoring which is to provide the basis for a comparison between measurements and predictions. The displacements, as predicted from numerical modelling studies, are indicated in Figure 12 by arrows. It is up to the Geotechnical Engineer to judge the degree of agreement achieved and to decide whether or not the geotechnical model will be acceptable or has to be refined.

In Europe, mobile borehole probes for high-definition ground displacement measurements around underground

openings are in common use. The most popular extensometer probe is the "Sliding micrometer", manufactured by SolExperts AG with a wide distribution in countries such as Switzerland, Germany and Eastern European countries. The "INCREX" probe, manufactured by Interfels GmbH, is popular in Italy, Austria and parts of Germany. The market for mobile inclinometers is highly contested between Glötzl GmbH, Sis-Geo s.r.l. in Italy and Slope Indicator (e.g. in Switzerland). The least common instrument is the mobile deflectometer, however, in recent years Interfels GmbH with its newly designed deflectometer probe has won a sizeable market share. Combined probes are manufactured by SolExperts AG, namely the extensometer / inclinometer probe "TRIVÉC" and the extensometer / deflectometer probe "LADEX".

### 3.2 Instruments for Measurement of Ground Stresses

Whilst a complete, well-proven and widely used set of instrumentation exists for monitoring of deformations in the ground, this is not necessarily the case for stress measurements and stress monitoring. From both a conceptual and technical point of view, the measurement of ground stresses (and the change of stresses) is generally much more difficult than that of the displacements. Some engineers make a virtue of this

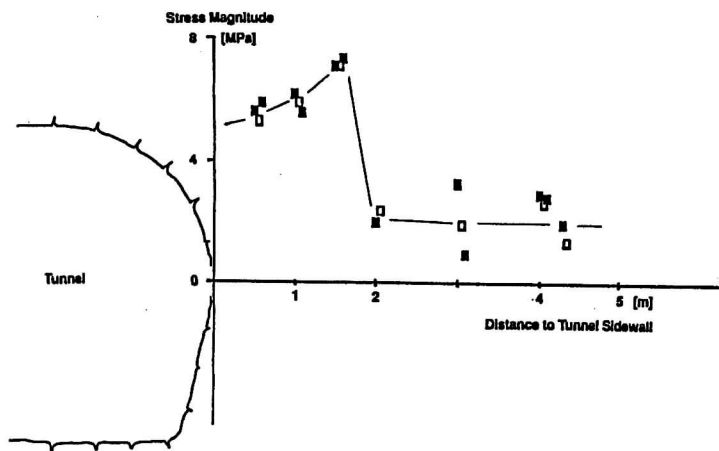

Figure 13. Stress measuring example: Distribution of the circumferential stresses in the sidewall rocks of a tunnel (Hagerbach / Switzerland)

#### Measuring task:

High-definition stress measurement in the sidewall rocks of a tunnel.

#### Main results:

- (1) Detailed evaluation of a stress profile with delineation of
  - the primary ("geologic") stress state amounting to appr. 2.0 MPa
  - the secondary stress state with an amount of maximally 8.0 MPa
- (2) Delineation of a 1.5 to 2.0 m wide "plastic zone"
- (3) The stress profile is indicative of a brittle failure behaviour of the ground.

situation when arguing that they can do without any stress measurement and stress monitoring. However as mentioned before, stresses are an intrinsic part of any geomechanical system and cannot be ignored if our considerations are to be complete.

Continuing problems with measuring and monitoring of ground stresses have lead a number of instrumentation manufacturers towards the development of improved or innovative stress measuring methods. Table 3 gives an overview of testing methods which are currently in the market. The table also gives an indication on the author's evaluation as to the various methods future development potential.

Figure 13 shows a stress measurement example. It indicates the distribution of the circumferential stresses in the sidewall rock of a tunnel as determined by borehole slotting. The high-definition measurements clearly delineate an approx. 2.0 m deep plastic zone. This information is important for the tunnel design, e.g. indication on the post-failure characteristics of the ground, confirmation of the rock loads and selection of proper lengths of the rock bolts.

Detailed and systematic investigations with objective comparisons between the various stress measuring and monitoring methods as well as comparisons between measured and predicted values are yet to be carried out in tunnel construction. Such investigations, however, are absolutely essential for improving our knowledge of tunnel systems, thereby permitting better design, safer and more efficient construction procedures.

#### 4 Conclusion

With reference to Continental Europe, the following trends can be identified with regard to performance monitoring of tunnels and other underground structures for design purposes:

- In terms of volume of work and turnover figures, *geodetic deformation monitoring represents the real backbone* of today's tunnel performance monitoring work.

- Much emphasis is currently given to the *integration of geodetic tunnelling surveying with traditional geotechnical monitoring methods*. The key for this approach is the availability of a suitable integrated acquisition and evaluation software.
- The interpretation of the common convergence and geodetic deformation measurements remains at a rather empirical level. This is seen as a major deficiency in current practice. It can be expected that in the near future a more rigorous *evaluation of the load bearing capacity of shotcrete linings* will become a widespread standard. The base requirements for such evaluation will be extensive geodetic deformation monitoring, in-depth knowledge of the material law of shotcrete and regular checking of the computed stresses by the slot cutting and flat jack compensation method.
- Measurements and monitoring of the *ground stresses*, principally desirable from an engineering point of view, *are still not in widespread use*. New high-definition stressmeters can delineate primary and secondary stresses around a tunnel at reasonable costs.
- Overall, it appears that, amongst tunnel engineers, there is no longer a strong interest in detailed instrumentation programs for checking and improving of the tunnel design as was the case some decades ago. This is in marked contrast to booming instrumentation demands for control of the construction procedures, as will be discussed in Part 2 of this contribution.

#### Appendix 1. List of Companies

- Geodata, Hans-Kudlich-Str. 28, A - 8700 Leoben, Austria, Tel. +43 - 3842 - 26 555 - 0, Fax: +43 -3842 - 26 55 55, Office@geodata.at
- Glötzl,Forlenweg 11, D - 76287 Rheinstetten, Germany,Tel. +49 - 721 - 5166 - 0 Fax: +49 - 721 - 5166 - 30, Gloetzl@compuserve.com

Interfels, Deilmannstr. 5, D - 48455 Bad Bentheim, Germany, Tel. +49 - 5922 - 98 98 - 0, Fax. +49 - 5922 - 98 98 98, Interfels-headoffice @t-online.de

Intermetric, Industriestr. 24, D - 70565 Stuttgart, Germany, Tel. +49 - 711 - 780 0392, Fax: +49 - 711 - 780 0397, Stuttgart@intermetric.de

SisGeo, Via Serpero S.P. 179, I - 20060 Masate MI, Italy, Tel. +39 - 02 - 957 64130, Fax: +39 - 02 - 957 620 11, info@sisgeo.com

Sol Data, 6 Rue de Watford, F - 92000 Nanterre, France, Tel. +33 - 1 -4776 5570, Fax: +33 - 1 - 4692 0365, jg.lafonta@soldata.fr

SolExperts AG, Ifangstr. 12, CH - 8603 Schwerzenbach, Switzerland, Tel. + 41 - 1 - 825 29 29, Fax: +41 -1 - 825 0063, Solexperts@access.ch

#### References

- Diekmann, N. and Kern, P., 1991. Investigations into the stability of drives in an underground mine. INCREX in combination with mobile inclinometer. - Interfels News, **4**: 15 - 18.
- Estermann, U., 1991. Application and data processing of INCREX measurements for near-surface tunnelling.- Interfels News, **4**: 3 - 9.
- Müller, L., 1978. Rock Construction, Vol. 3: Tunnelling (in German). - 945 p., Stuttgart (Enke).
- Rokahr, R. B. and Zachow, R., 1999. A new method for the daily control of the load bearing capacity of a shotcrete lining (in German). - Unpubl. Report, 7 p., Hanover (Univ. Inst. for Subsurface Construction)

*Helmut Bock, Geotechnical Consultant, Past-President of Interfels GmbH, Stoltenkampstr.1, D - 48455 Bad Bentheim, Germany Tel: +49 - 5922 - 2700 Fax: +49 - 5922 - 2799, QS-Consult@t-online.de*

# Advances in Fabry-Perot Fiber Optic Sensors and Instruments for Geotechnical Monitoring

**Pierre Choquet**  
**Marco Quirion**  
**François Juneau**

One of the most recent and exciting developments in the field of civil engineering instrumentation, especially in geotechnical and structural instrumentation, are fiber optic sensors. This new type of sensors creates a strong interest among practitioners and researchers.

Several technologies based on different principles, such as Fabry-Perot interferometry, Bragg grating and polarimetry are well documented in the literature (Udd 1995; Culshaw & Dakin, 1996). Small size, fast response and immunity to lightning surcharges, radio frequencies and electromagnetic interferences are among the list of advantages of these sensors. Tsang & England (1995) describe potential applications of the three above-mentioned techniques for fiber optic sensing in geotechnical engineering and give example on how they can be applied to tension monitoring in wall anchorage and bridge bearing monitoring. Choquet et al. (1997, 1999) present early calibration results on Fabry-Perot fiber optic strain sensors and Idriss et al. (1997) give results of Bragg grating fiber optic sensor application to highway bridge monitoring. Since then, practical advancements have been achieved. The objective of this article is to explain the working principle of the Fabry-Perot interferometric sensor to give a better understanding of this technology and to present different models of field tested instruments which are now available for static and dynamic monitoring of strain, displacement, pore pressure and settlement. Also, a portable readout unit and

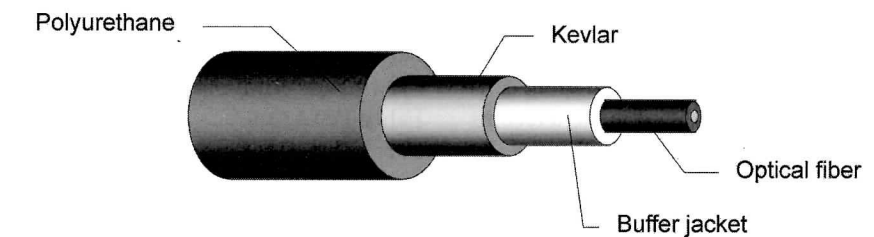

Figure 1. Structure of a fiber optic cable.

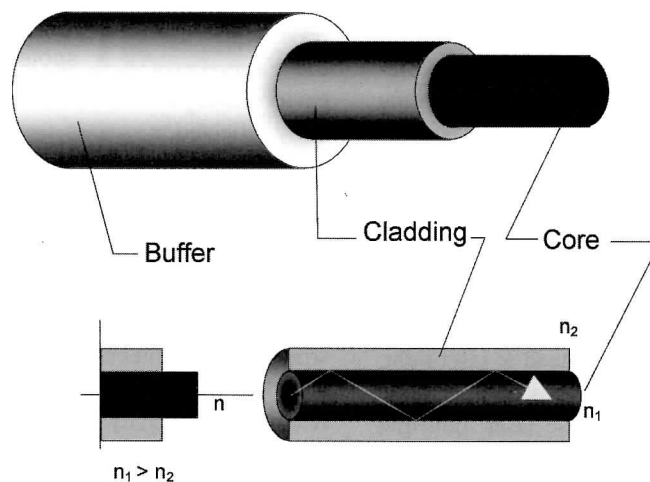

Figure 2. Light signal propagation in fiber optic.

a 32-channels fiber optic data acquisition system allowing on-site and remote monitoring are presented.

## Fiber Optic

Ordinary instrumentation is generally based on the measurement of an electrical signal conducted in copper wires. Fiber optic cables are structured in a way that allows light rays to be kept inside and to travel very fast on long distance with low signal loss. Figure 1 is a schematic representation of the structure of

a fiber optic cable. The basic parts, core and cladding, are made of silica, covered with a buffer, generally made with an elastomeric material, providing mechanical strength and protection. The fiber optic is also provided with an outside protective jacket and an internal strength member, usually Kevlar, which avoids putting stress on the fiber itself during installation and afterwards. All fiber optic are made with dielectric material giving the cable complete electromagnetic, radio frequency and lightning immunity. High temperature versions of



fiber optic cables are also available. Another advantage is the low attenuation of fiber optic. Typical loss of fiber optic is 1 dB/km and less, meaning that approximately 80% of the light signal reaches the end of a 1 km long fiber optic cable. In case of interferometric sensors, such as Fabry-Perot and Bragg grating, measurement quality is unaffected by this amount of attenuation, so that longer cables can even be used. Light signals propagate by internal reflections in fiber between the core and cladding, which have different refraction indices ( $n$ ) as illustrated in Figure 2.

Connections are achieved using connectors commonly used in the telecommunication industry, which may be provided with harsh environment protection caps and cable netting. Junction boxes are available to regroup connectors. Splicing of broken cables is also possible using readily available kits and techniques from the telecommunication industry. Fiber optic connectorization and splicing remain however techniques which are new to the geotechnical community, so that a certain level of training and acquaintance is required.

### Fabry-Perot Technology

The Fabry-Perot interferometric principle presented in this article is based on interference of light rays, as explained in the following section. It makes use of white light source instead of laser light. Many of the other types of fiber optic sensing techniques use laser light that may need special care (e.g. preheating time of light source, constant temperature). Also, insensitivity to thermal variations and to transverse strains are among the advantages of Fabry-Perot sensors (Choquet et al., 1997, 1999).

### Extrinsic Fabry-Perot Sensor

A basic strain gage construction is illustrated in Figure 3. The Fabry-Perot gage is an extrinsic sensor, meaning that the sensing element is external to the optical fiber. It consists of two mirrors facing each other and these mirrors are made of semi-reflective coating deposited on the tips of optical fibers spot fused into a capillary. In the present stage of the technology, the air gap between the mirrors,

called the Fabry-Perot cavity length ( $l_{\text{cavity}}$ ), varies between almost zero to a few tens of microns respectively when the gage is fully compressed or fully extended. The distance separating the fused spots is called the gage length ( $L_g$ ) and corresponds to the actual measuring base of the strain gage.

A light signal, produced by a white light emitting diode, is launched into one end of a fiber optic cable by a readout unit and reaches the Fabry-Perot sensor located at the other end. As mentioned above, light propagates by internal reflections in the fiber optic and reaches the Fabry-Perot sensor. The first semi-reflective mirror reflects a portion of the white light emitted by the readout unit. The remaining light travels through the Fabry-Perot cavity and is partially reflected, a second time, by the next semi-reflective mirror. The light from the two reflections interfere, meaning that the original white light becomes separated in several wavelengths and travels back to the readout unit. Cavity length ( $l_{\text{cavity}}$ ) is determined instantaneously by means of an optical white light cross-correlator contained in the readout unit. The next section will explain this device and how the signal is analysed. When the gage is bonded to a substrate, a strain variation in the axial direction of the strain gage will produce a variation of the cavity length ( $l_{\text{cavity}}$ ); the strain is given by the following equation:

$$\text{Strain}(\epsilon) = \frac{\Delta l_{\text{cavity}}}{L_g}$$

The Fabry-Perot cavity can also be laid out in different ways in order to make different types of instruments, as in the case of the pressure sensor described in a further section.

### Processing of Light Signal

The conversion of the optical signal into measurement of a physical value is achieved using a Fizeau interferometer and a linear CCD (Charge Coupled Device) array combination (Fig. 4) in the readout unit; this combination is also called a white light cross-correlator. Detailed theoretical considerations given by Belleville and Duplain (1993) on this cross-correlator and light signal processing are summarised hereafter. The light signal reflected back by the Fabry-Perot strain gage illuminates the complete width of the Fizeau interferometer,

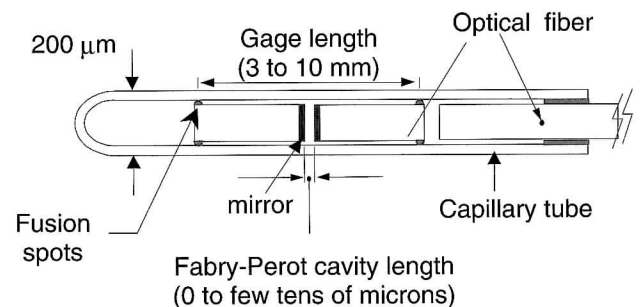

Figure 3. Extrinsic Fabry-Perot fiber optic sensor for the measurement of strain.

which consists in a spatially-distributed interferometer whose thickness varies from almost zero to a few tens of microns, namely exactly the same values as the minimum and maximum values of the Fabry-Perot cavity length. The light transmitted through the Fizeau interferometer displays a peak of power at the exact location along the interferometer where thickness of the interferometer is equal to the Fabry-Perot cavity length of the sensor. The linear CCD array located on the backside of the Fizeau interferometer is used to locate the position of the light power peak along the Fizeau interferometer, so that the Fabry-Perot cavity length becomes known.

As opposed to relative measurement of strain or displacement related to an arbitrary zero value, the Fabry-Perot cavity length measurement is said to be absolute because it corresponds to a true

physical value. Absolute measurement is useful for long term monitoring applications as it guarantees that the same readings will be obtained in the future, should readouts be interchanged. At the present stage of the technology, the optical signal can be converted to cavity length at a frequency of 1000 Hz, in the case of dynamic monitoring applications. Also, readout units exhibit a resolution slightly better than 0.01 % full scale and a precision of 0.025 % full scale.

**Fabry-Perot Sensors and Instruments**

In the recent past, research and development efforts have led to the design of different types of fiber optic sensors and instruments based on Fabry-Perot white light interferometry. Strain, temperature, displacement and pressure sensors are available. More recently, a soil settlement gage and a total pressure cell have been developed. The following sections present the main types of Fabry-Perot sensors and instruments for geotechnical monitoring together with a few results obtained from laboratory or field applications.

**Pressure Sensor and Piezometer**

Design of fiber optic pressure sensors, from which piezometers can readily be built, is based on a non-contact measurement of the deflection of a stainless steel diaphragm, in contrast to more conventional measurement of diaphragm deformation. Pressure applied on a stainless steel diaphragm produces a deflection of its inner surface. This deflection causes a variation of the spacing between the inner surface of the diaphragm and the tip of a fixed optical fiber. The spacing between the steel diaphragm and the end of the optical fiber becomes a Fabry-Perot cavity as illustrated in Figure 5. The geometry and material of the transducer are selected in order to obtain a linear relationship between diaphragm deflection and applied pressure.

Piezometers were tested in the laboratory and in the field. Figure 6 presents a laboratory calibration of the applied pressure on the diaphragm versus the

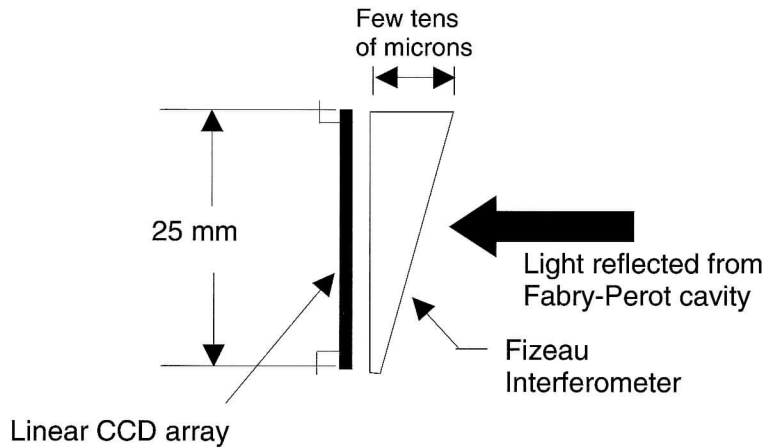

Figure 4. Fizeau interferometer and CCD array contained in the readout unit.

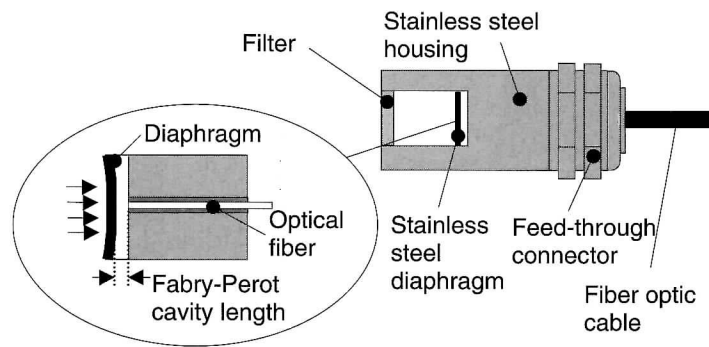

Figure 5. Operating principle of a Fabry-Perot fiber optic piezometer.

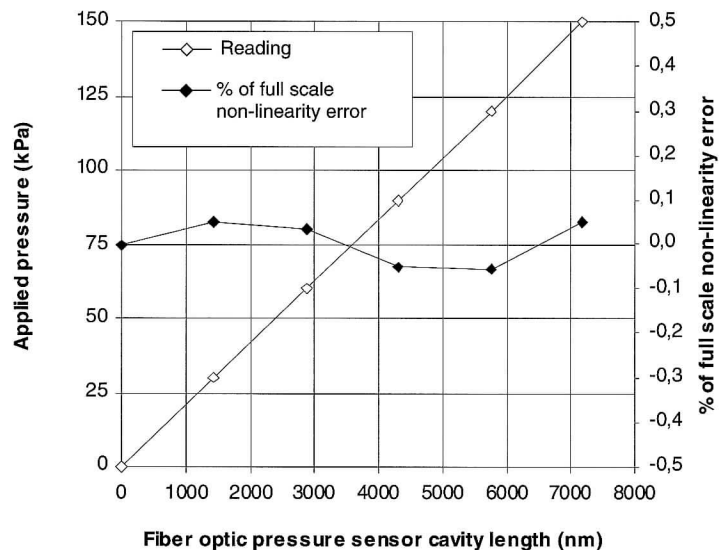

Figure 6. Calibration curve of fiber optic pressure sensor.

Fabry-Perot cavity length for a 0-175 kPa piezometer. The working range of the Fabry-Perot cavity length is between 0 to 9 000 nm. Also, the maximum non-linearity error of the sensor tested is 0.06% of full scale as illustrated on Figure 6 and the measured thermal sensitivity was lower than 0.1% full scale/°C. A factory-assessed thermal correction factor is provided for each instrument although piezometers are generally installed in locations where temperature do not change considerably. Mechanical robustness of the sensor is ensured by all welded stainless steel construction and there is no use of epoxy, sealing rubber, or other kind of polymeric materials.

Figure 7 presents comparative results from a field application where a fiber optic and a vibrating wire piezometer were installed at the same depth in a borehole and were used to measure fluctuating water levels in it during 110 days. As it can be observed in Figure 7, the two instruments gave completely similar results. Recently, the same fiber optic pressure sensors were used in the development of a fiber optic total pressure cell and a liquid level soil settlement gage.

**Displacement Sensor**

A displacement sensor, based on Fabry-Perot and Fizeau interferometer, has been developed (Duplain et al., 1997). Figure 8 shows the displacement sensor used as a jointmeter on a concrete structure for monitoring displacements. Figure 9 shows the calibration curve of this jointmeter using a digital micrometer table as reference. Correspondence between the reference reading in mm and the response of the transducer is shown in Figure 9 together with the non-linearity error. The working range of the sensor is 25 mm and the maximum non-linearity error is 0.15% full scale but most of the reading errors are lower than 0.10% full scale. The resolution of the sensor is 0.002 mm. This sensor compares favourably in performance with more conventional displacement sensors such as LVDT, linear potentiometer and vibrating wire which display generally non-linearity errors ranging from 0.1 to 0.25% full scale.

**Strain Gages**

Different types of fiber optic strain gages are available for various applications. Surface-weldable (Fig. 10a), concrete embedment (Fig. 10b) and surface mounted gages suitable for installation on composite materials have been used in the field and in the laboratory (Benmokrane et al. 1999).

The embedment strain gage for measurements in concrete is made with a Fabry-Perot strain sensor, such as that illustrated in Figure 3, which is bonded inside a stainless steel envelope incorporating end flanges. As an illustration of the performance of these gages, internal laboratory compression and traction tests performed on 32 embedment sensors have shown an average non-linearity error of 0.23 % full scale. Laboratory investigation of embedment sensors in concrete are published in Quirion et al. (1998). Both types of Fabry-Perot strain sensors, surface and embedment, are manufactured in two configurations. The first configuration is used to measure strain due to combined mechanical and thermal effects in the structure and the second configuration is used to measure strictly mechanical effects, thanks to a thermally-compensated construction of the strain

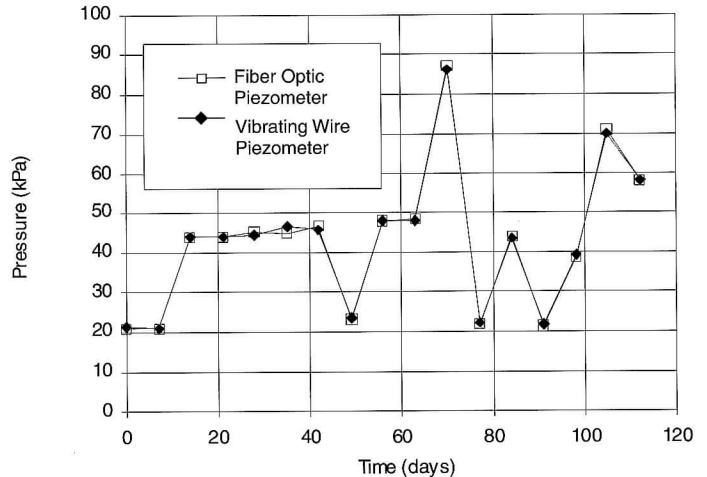

Figure 7. Compared water level measurements with fiber optic and vibrating wire piezometers in a borehole.

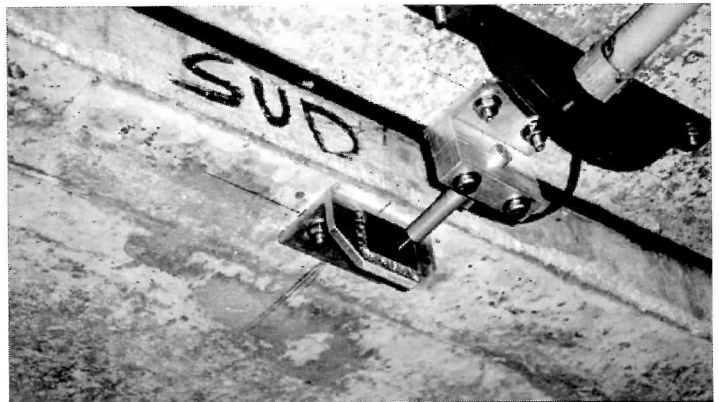

Figure 8. Fiber optic displacement sensor installed between two concrete sections.

sensor (Choquet et al., 1997).

Several sensors are also embedded in concrete for monitoring different construction projects. These projects include several bridges, among them the Joffre Bridge located in Sherbrooke, Canada (Benmokrane et al. 1999). In this last field application, many fiber optic sensors were integrated in reinforcement composite materials and embedded in the bridge concrete in parallel to vibrating wire sensors. Other typical field and construction projects incorporating fiber optic strain sensors include a multiple-floor parking lot, a retaining wall, an airport runway, a sea wharf, a test pavement and a telecommunication tower.

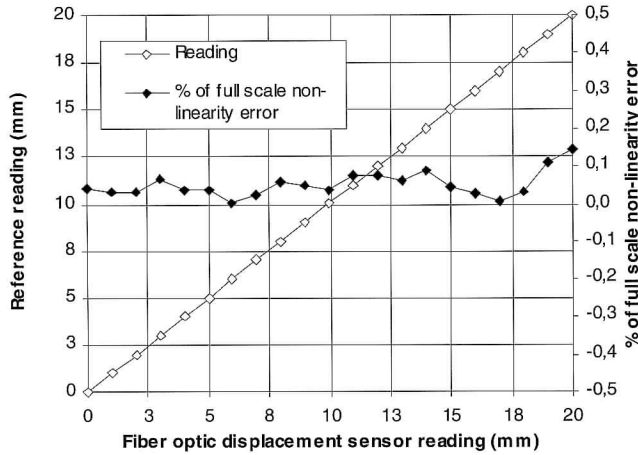

Figure 9. Calibration curve of displacement fiber optic sensor of Figure 8.

**Readout Units and Dataloggers**

All readout units for the Fabry-Perot sensors have a white light as light source. Figure 11a illustrates a single channel battery-operated portable readout unit. Also, a 32-channel datalogger is available for static and semi-dynamic monitoring (Fig. 11b). Both are designed for field and laboratory use. Sweep delay for channel switching is 150 ms so that all 32 channels can be read in less than five seconds. This readout has a memory of 60 000 samples and a frequency rate of 20 Hz on each individual channel, meaning that 20 readings per second can be taken to monitor semi-dynamic loading. Strain data can be taken manually or the unit can be connected to a PC computer through an RS-232 link. The information extracted by the 32-channel datalogger can also be transmitted over a phone line to a central monitoring station. For true combined static and dynamic monitoring, multi-channel bus systems allowing reading of all channels simultaneously at a frequency rate of up to 1000 Hz are also available. One advantage of all readout models is their universality, because they allow reading of different transducer types, all based on the Fabry-Perot principle. The user only needs to enter a gage factor to define the gage type, range and sensitivity in the permanent memory of the readout unit; the readings are directly displayed in engineering units.

**Conclusions**

The working principle together with laboratory and field results of different fiber optic sensors and instruments based on Fabry-Perot white light interferometry are presented in this article. Their main advantages over conventional geotechnical and structural instruments include fast response allowing both static and dynamic monitoring, absolute measurement, intrinsic immunity to lightning strikes and other interferences and low attenuation of light signals in long fiber optic cables. Fiber optic instruments presented in the article include a piezometer, a displacement sensor, surface and embedment strain gages, a total pressure cell and a liquid level soil settlement gage. Different readout units and dataloggers are available for use in the field so that geotechnical monitoring activities of safety and performance of earthworks and major structures, such as tunnel, bridges, concrete and earth dams, can now benefit of these advances.

**References**

Belleville, C., Duplain, G. (1993) "White-light interferometric multimode fiber-optic strain sensor", *Optics Letters*, vol. 18, no. 1, pp.78-80.

Benmokrane, B. & al. (1999) "Design, Construction and Monitoring of FRP Monitoring of Reinforced Concrete Bridge Deck", *Proceeding of the Fourth International Symposium on Fiber Reinforced Plastic Reinforcement for Concrete Structures (FRPRCS 4)*, Baltimore, November 1999.

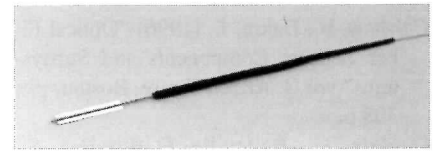

Figure 10a) Spot-weldable Fabry-Perot strain gage.

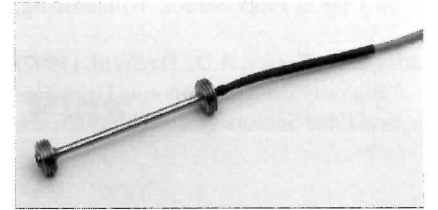

Figure 10b) Fabry-Perot embedment strain gage.



Figure 11a) Portable fiber optic readout unit designed for field applications

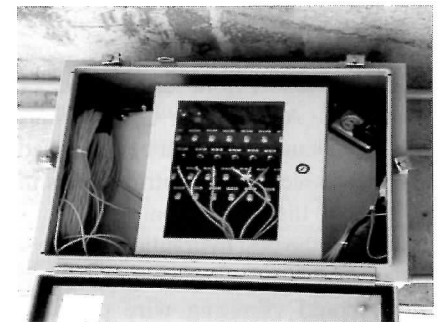

Figure 11b) Thirty-two channels datalogger installed for field monitoring.

Choquet, P., Juneau, F., Dadoun, F. (1999) "New Generation of Fiber-Optic Sensors for Dam Monitoring", *Proceedings of the 1999 International Conference on Dam Safety and Monitoring*, 19-22 October 1999, Three Gorge Project Site, Yichang, Hubei, China, pp. 713-721.

Choquet, P., Leroux, R., Juneau, F. (1997) "New Fabry-Perot Fiber Optic Sensors for Structural and Geotechnical Monitoring Applications", *Transportation Research Record*, no 1596, pp.39-44.



Culshaw, B., Dakin, J., (1996) "Optical Fiber Sensors Components and Subsystems" vol. 3, Artech House, Boston, 308 p.

Duplain, G., Belleville, C Bussière, S., Bélanger, P.A. (1997) "Absolute Fiber-Optic Linear Position and Displacement Sensor", 12th International Conference on Optical Fiber Sensor, Williamsburg, VA.

Idriss, R.L., Kersey, A.D., Davis, M. (1997) "Highway Bridge Monitoring Using Optical Fiber Sensors", Geotechnical News,

Vol. 15, no. 1, pp. 43-45.

Quirion, M., et al. (1998) "Behaviour of embedded fiber optic strain gauge in concrete: Experimental and numerical simulations", International Symposium on High Performance and Reactive Powder Concretes, Sherbrooke, Quebec, Canada, Vol. 4, p. 297-313.

Tsang, C.M. and England, G.L. (1995) "Potential of Fibre Optic Sensing in Geotechnical Applications", Geotechnical News, Vol. 13, no. 4, pp. 36-39.

Udd, E. (1995) "Fiber Optic Smart Struc-

tures", John Wiley & Sons, New York, 671 p.

*Pierre Choquet, First Vice-President, Email: pchoquet@roctest.com.; Marco Quirion, R&D Engineer, Email: mquirion@roctest.com.; François Juneau, R&D Engineer, Email: fjuneau@roctest.com., Roctest Ltd., 665, Pine Ave., St-Lambert, Quebec, Canada, J4P 2P4, Phone: (450) 465-1113, Fax: (450) 465-1938 www.roctest.com*

## Vibrating Wire Settlement Cells - an Alternative Technique

**John McRae**

In the previous issue of GIN (Geotechnical News, Vol.17, No. 4, December 1999, pp.35-42), Wing Heung described some problems with readings of vibrating wire settlement cells, and reported on investigations to examine the possible causes of the problems. The article was followed by two discussions, and a closure by the author. In his discussion John Dunncliff wrote, "I don't want to inhibit any reader from sending another discussion. Any further contributions will be welcome, and will be published in a later issue." This contribution is in response to that suggestion.

Ideally, the best hydraulic settlement system would be comprised of a drift-free, vented vibrating wire pressure transducer connected by a continuous liquid-filled tube to a stationary reservoir in a constant temperature environment. The liquid would have a very low thermal coefficient of expansion and would be free from air bubbles.

All of these ideal elements cannot be achieved. However, systems do exist that utilize a vented transducer in a closed loop, i.e., the space inside the transducer is connected to the space above the liquid in the reservoir. These systems have the following characteristics:

- The need for barometric pressure corrections is eliminated.
- Because the loop is closed there are

no fluctuations due to wind, delayed barometric equalization in the air line, etc.

- Evaporation is minimized, because the system is not exposed to the atmosphere.
- The system allows for pressurization of the liquid to drive any bubbles into solution, leaving a continuous liquid column. The added benefit of using the vented transducer is that the back-pressure is applied to both sides of the diaphragm, resulting in no increase in pressure sensed by this balanced application. What's left is only the pressure applied by the liquid. The back-pressure can be applied in approximate increments, and at the stage where all the bubbles are "squashed" the sensor output will cease to change.

- The continuity of the vent line can be easily checked at any time by applying a small pressure (or vacuum) to the vent line, observing the change in reading, and then allowing the pressure to equilibrate again after reconnecting the line into the system.
- Another possibility that exists with this system, and with the one described in the article, is to flush out the liquid altogether with nitrogen gas and to then check the instrument zero reading.

A schematic of the system is shown in the accompanying figure.

*John B McRae, Vice President, Geokon, Inc., 48 Spencer St., Lebanon NH 03766  
Tel: (603)448-1562  
Fax (603)448- 3216,  
e-mail: john@geokon.com*

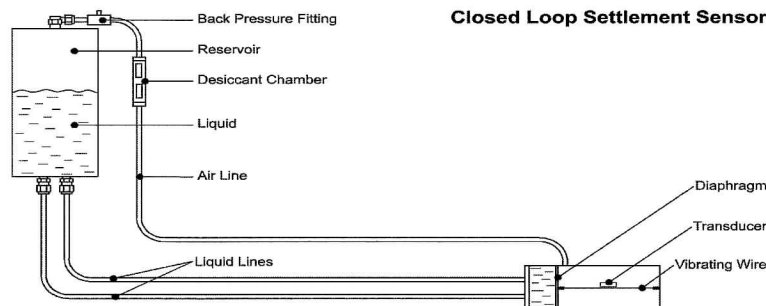

**Closed Loop Settlement Sensor**