

Gesellschaft für Anlagen- und Reaktorsicherheit (GRS) gGmbH

The Nuclear Simulation Chain of GRS

Andreas Schaffrath (andreas.schaffrath@grs.de)

Sebastian Buchholz (sebastian.buchholz@grs.de)

Anne Krüßenberg (anne.kruessenberg@grs.de)

Daniel von der Cron (daniel.vondercron@grs.de)

IAEA International Conference on *Topical Issues in Nuclear Installation Safety: Safety Demonstration of Advanced Water Cooled NPP*

Vienna (Austria), June 6 – 9, 2017



Outline

- Introduction
 - Andreas Schaffrath
 - Gesellschaft für Anlagen- und Reaktorsicherheit (GRS) gGmbH
 - Division Reactor Safety Research
- GRS Nuclear Simulation Chain
- Safety demonstration for Advanced Water Cooled Designs
 - German and European Frame
 - ATHLET code
 - Necessary TH improvements for AWCR (SMR)
- Summary and Outlook

Andreas Schaffrath

- **Name:** Dr.-Ing. Andreas Schaffrath
- **GRS Affiliation:** since February 2013
- **Actual Position:** Head of division *Reactor Safety Research*

- **selec. Competences/Memberships:**

- innovative reactor concepts and passive safety systems
- construction / operation of large TH test facilities (**NOKO (FZJ)**, **TOPFLOW (HZDR)**)
- system code model (ATHLET) development, validation and its application
- 10 years of experience in nuclear licensing- / supervisory procedures (at TÜV NORD)
- Head of staff unit R&D (at TÜV NORD)
- member of the PRG of CSNI of OECD/NEA
- member of several TPC (NURETH, NUTHOS, ...)



Gesellschaft für Anlagen- und Reaktorsicherheit (1)

- main **Technical Support Organization (TSO)** in **nuclear safety** for the **German federal government**:
 - **BMUB** (Federal Ministry for the Environment, Nature Conservation, Building and Nuclear Safety)
 - **AA** (Federal Ministry of Foreign Affairs)
 - *regulatory research / work: performance of safety analyses, preparation of regulatory fundamentals or experts opinions, development of assessment / acceptance criteria*
- **major research organization** in **nuclear safety** funded by:
 - **BMWi** (Federal Ministry of Economic Affairs and Energy),
 - **BMBF** (Federal Ministry for Education and Research), **BMUB**
 - *generic reactor safety research: (further) development / validation of evidence tools*
- involved in **int. activities** (e.g. **IAEA**, **OECD / NEA** and **EC**)

Gesellschaft für Anlagen- und Reaktorsicherheit (2)

technical divisions

General Management				
U. Stoll		H. J. Steinhauer		
MANAGEMENT STAFF				
Press Officer S. Dokter	Corporate Social Responsibility C. Vieten	IT-Management E. Kardes	International Affairs & Quality Management C. Eibl-Schwaeger	Internal Audit I.-M. Koch Dr. H. Kunitz

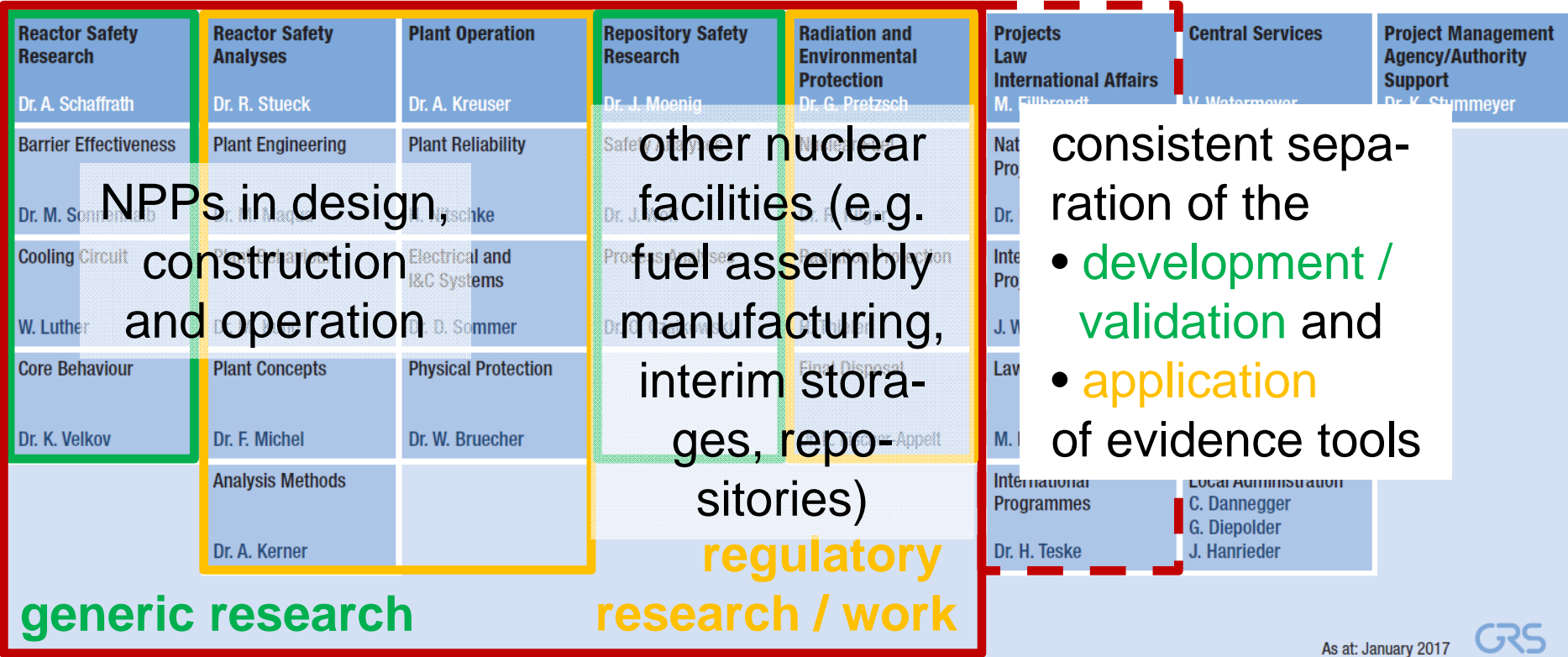

As at: January 2017

Division *Reactor Safety Research*

- structure is oriented to the **nuclear safety goals**

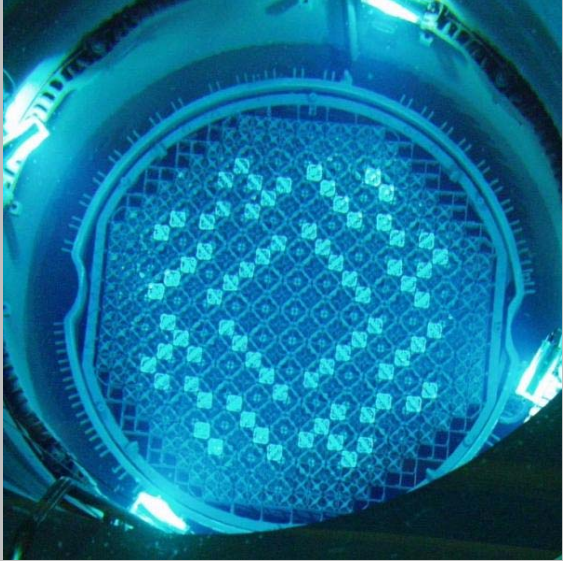
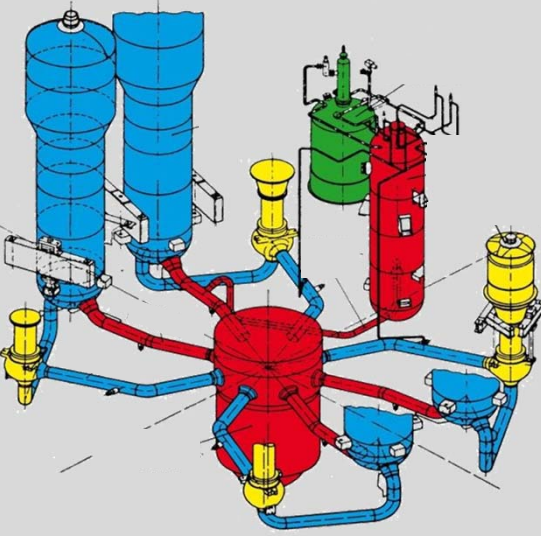
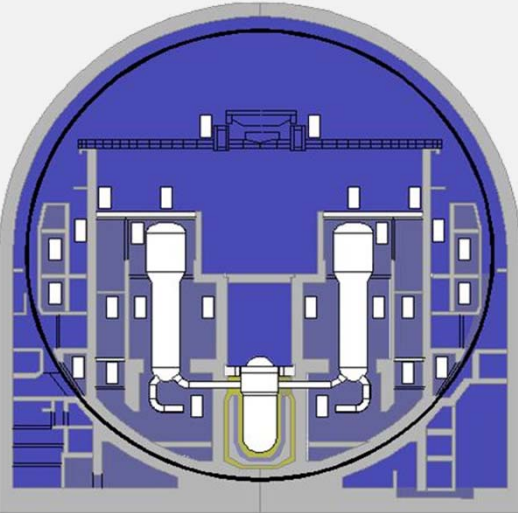
control of reactivity	core cooling	enclosure of radioactivity
		
Dep. Core Behavior	Dep. Cooling Circuit	Dep. Barrier Effectiv.
15 employees	25 employees	20 employees
reactor physics, core and fuel behavior	thermal hydraulics, CFD, transients, accidents as well as severe accidents	severe accidents, aerosol, iodine, H ₂ phenomena, structural mechanics, CFD

Division Reactor Safety Research

- our products are **scientific codes** for analyses of **operational states, incidents, accidents, severe accidents in NPP**
 - representing **state-of-the-art science and technology**
 - forming together a **nuclear simulation chain**
- **publications** in scientific journals and conferences
- historically, GRS has developed own codes in several areas
 - this leads to improved understanding of physical phenomena
 - widely independent of others (e.g. the interests of commercial software developers)
- we are co-operating with national / international organizations
 - forward-looking strategy to cope with currently limited resources
 - to share development efforts by using results in research alliances and networks
 - transferring our codes to other organizations (e.g. TÜV, TSO and regulators esp. in Eastern Europe, Asia) and conduct training programs

GRS Nuclear Simulation Chain (1)

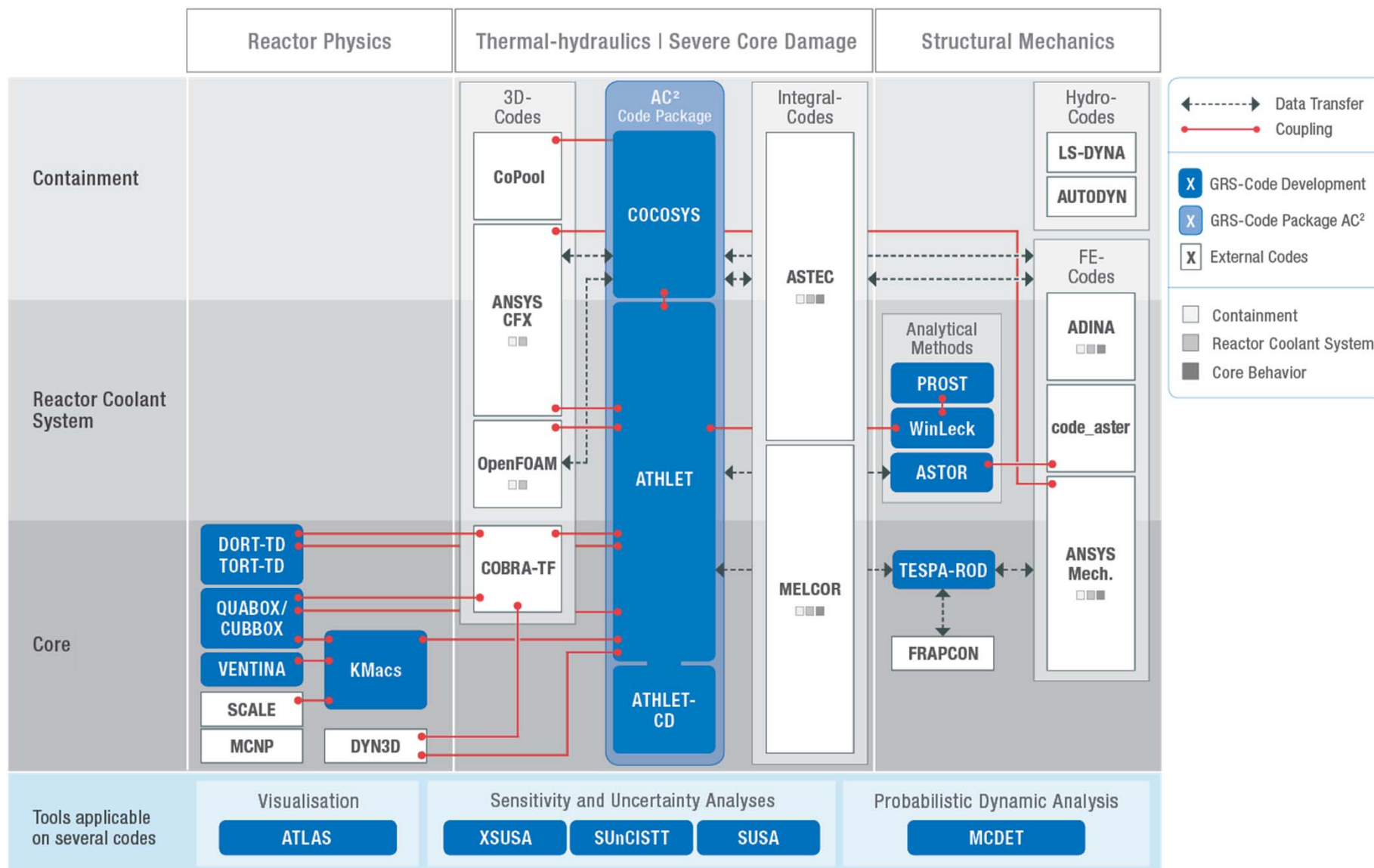

GRS Nuclear Simulation Chain (2)

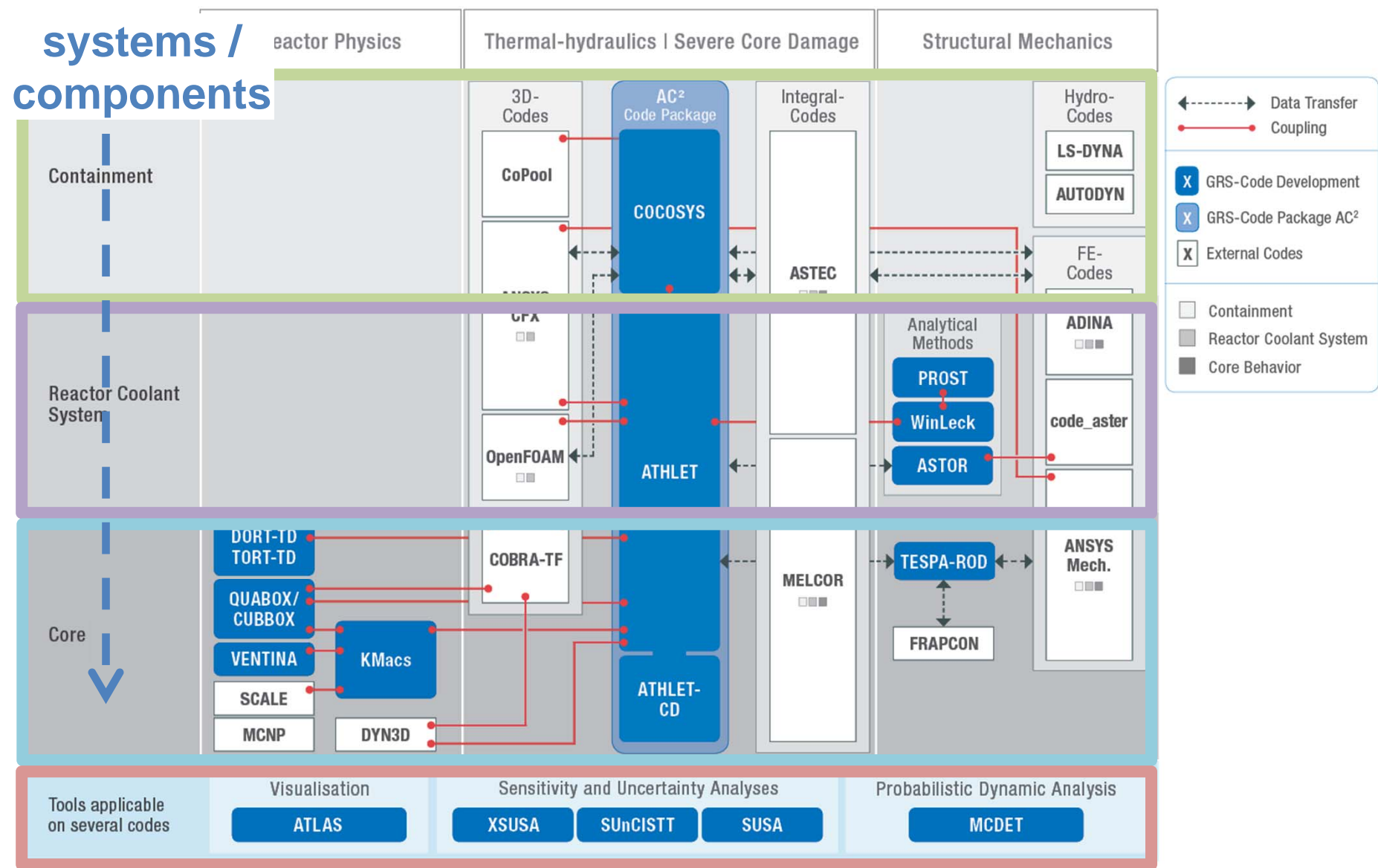

GRS Nuclear Simulation Chain (3)

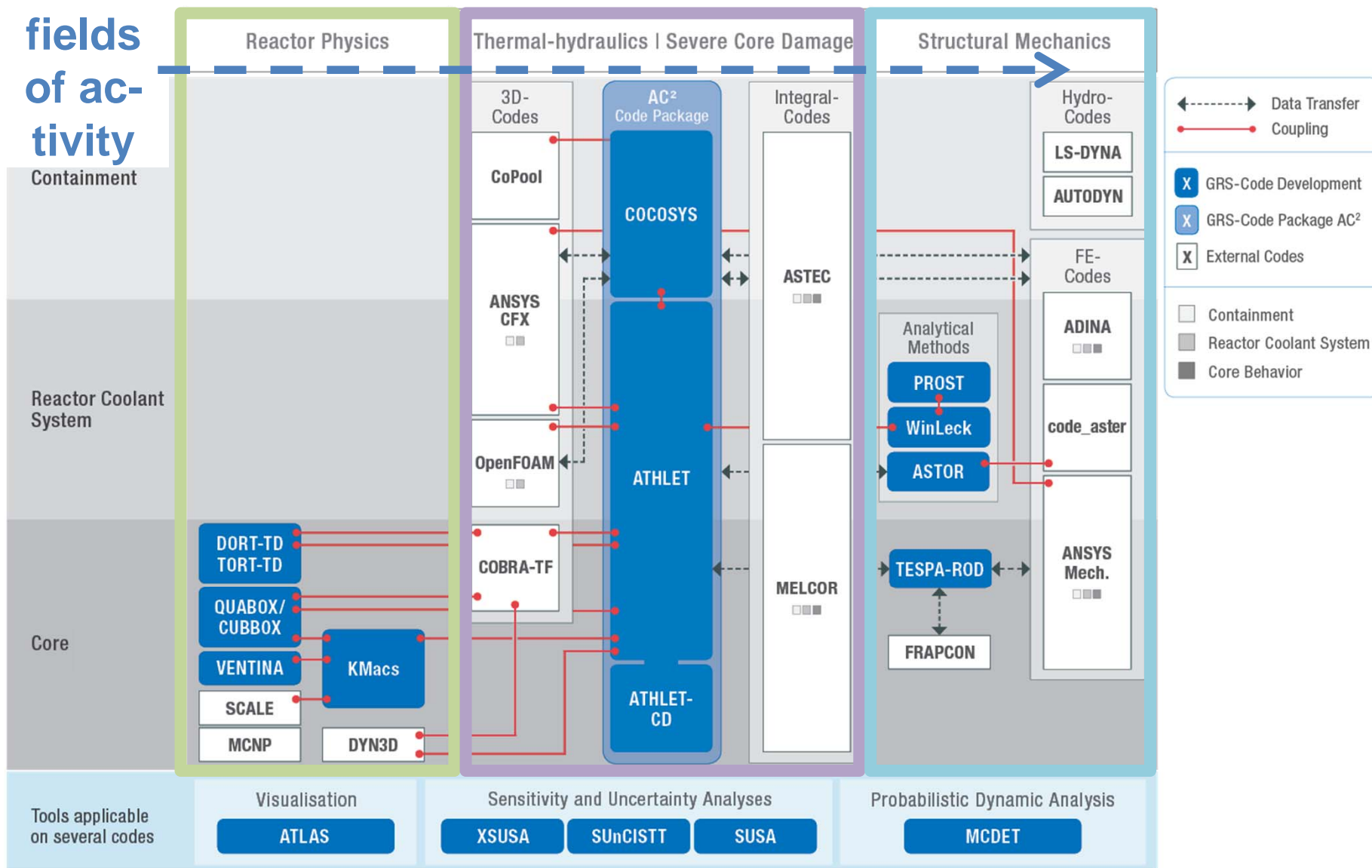

GRS Nuclear Simulation Chain (4)

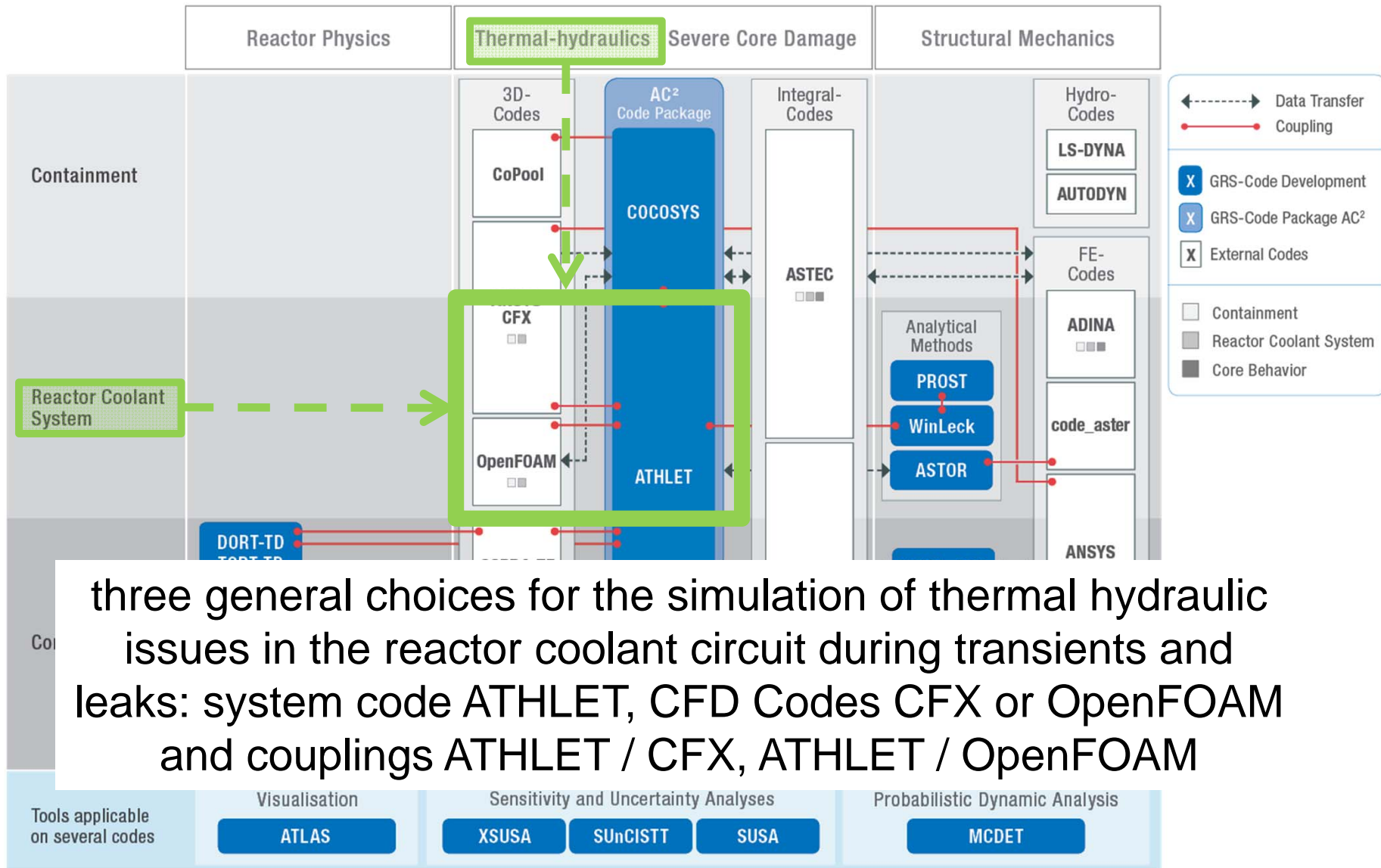

GRS Nuclear Simulation Chain (5)

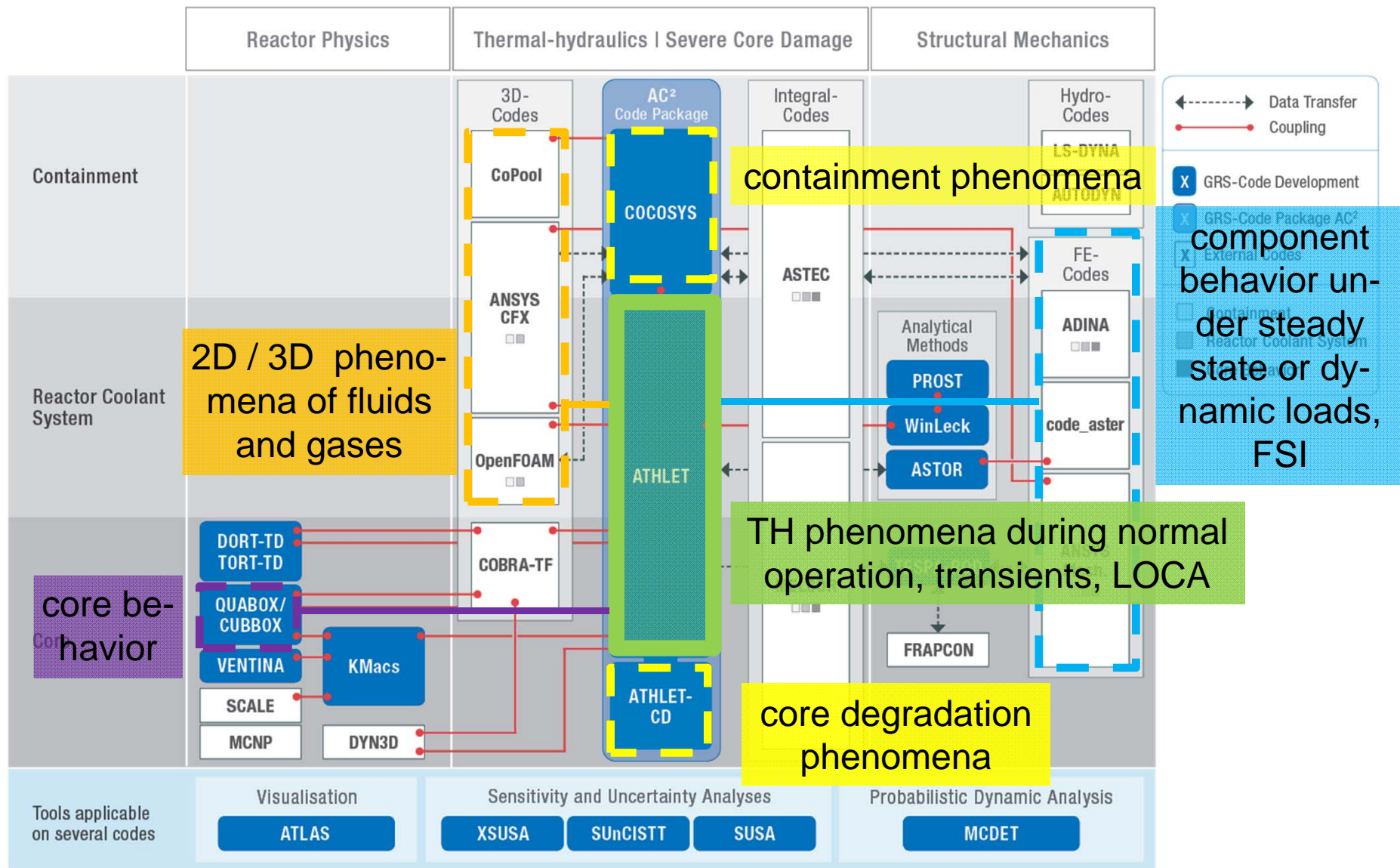

Safety demonstration for advanced NPP - German Frame

- the GRS nuclear simulation chain was originally developed for Gen. II reactors
- application for advanced designs requires further developments and validation
- 13th Amendment of the Atomic Energy Act came into force on 6 August, 2011
 - licenses of the 7 oldest NPPs and of the Krümmel NPP expired
 - stepwise shutdown of the remaining 9 NPPs until 2022 (2015 KKG)
- but ***no Phase out*** of nuclear energy research in Germany

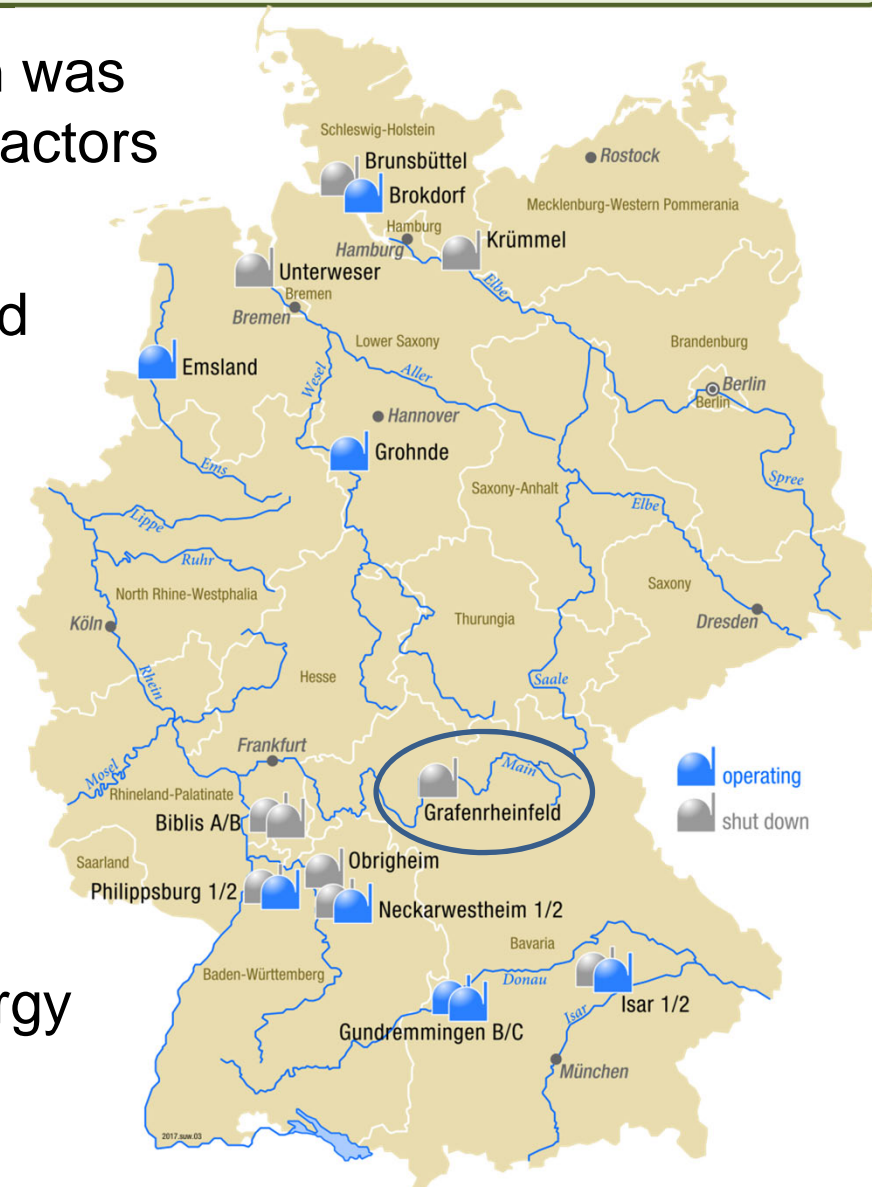

Safety demonstration for advanced NPP - Europ. Frame

- in Europe, national government policies differ, some countries are planning to
 - build new NPPs (e.g. France, Russia, UK, Finland, Hungary) or
 - maintain and/or extend service times
- GRS will further develop and validate our simulation chain, so that it can be applied for resp. safety analyses
- most of the new builds and reactor concepts under development are innovative designs such as Gen. III, **Gen. III+**, Gen. IV, **SMR** with new safety features (e.g. **passive safety systems**)
- example: current **ATHLET improvement / validation** activities

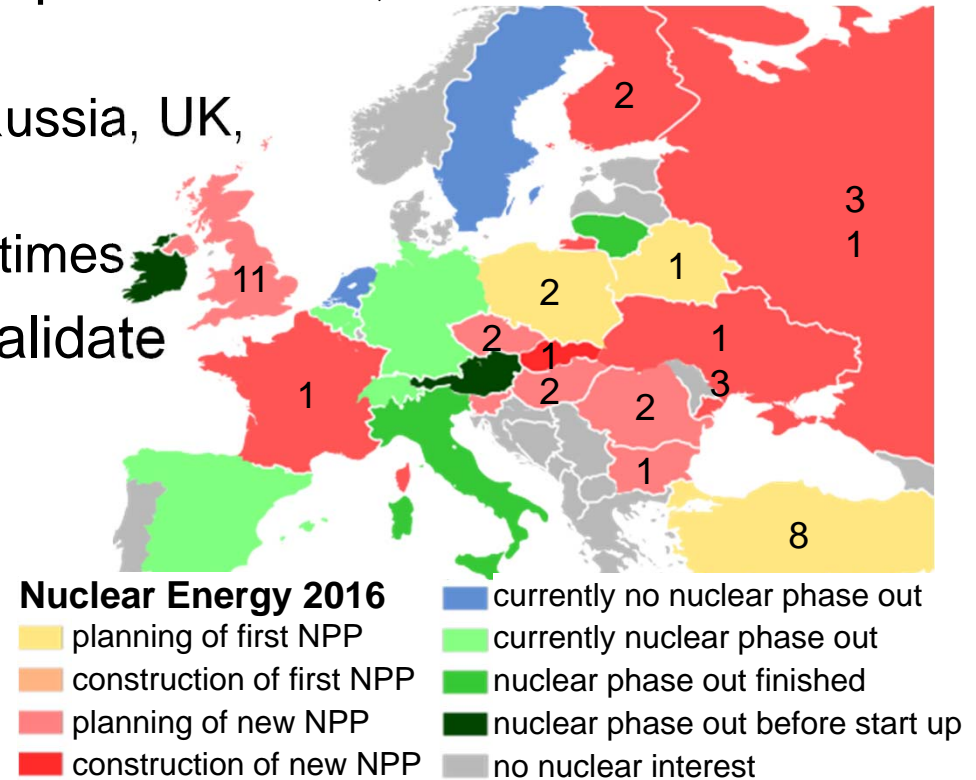

ATHLET (Analysis of the Thermal Hydraulics of Leaks and Transients)

- originally developed for the analysis of the complete spectrum of leaks and transients in (western type) PWR and BWR
- currently ATHLET can simulate all different kinds of LWR (**Gen. II, III, III+** PWR, BWR, VVER, RBMK), water cooled Small Modular Reactors (**SMR**)
- material properties for Accelerator Driven Systems (**ADS**), **Gen. IV** reactors cooled with
 - supercritical water (**SCWR**),
 - gas (Very) High-Helium (**VHTR**),
 - liquid metals e.g. sodium or lead-bismuth (**SFR, LFR**)
- **systematic validation** of ATHLET based on a well balanced set of integral and separate effect tests derived from the CSNI code validation matrices

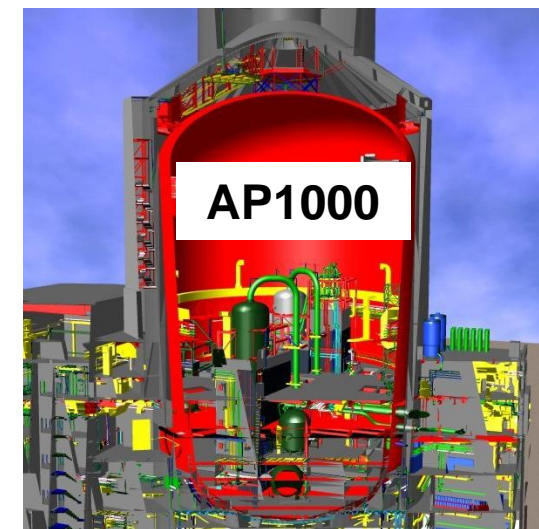

Necessary TH improvements for AWCR (1)

- **passive safety systems** have a great potential to control DBA and BDA (in Gen. III+ PSS solely control accidents)
- operation mode is based on laws of nature (free convection, condensation, evaporation) with usually small driving pressure and high temperature differences
- model development/validation
 - condensation inside horizontal tubes
 - (subcooled) boiling
 - temperature and flow fields (stratification) in large water pools
 - interactions of
 - different trains of one system or
 - between different passive safety systems
 - accumulation of non-condensables
 - natural circulation and flow instabilities at phase transition

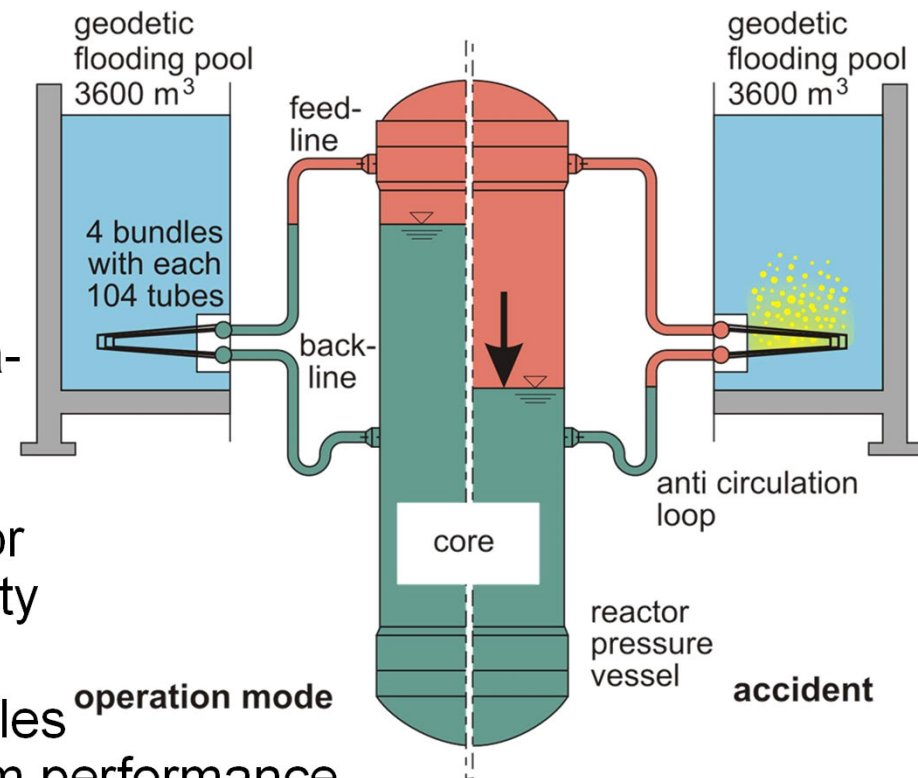

Necessary TH improvements for AWCR (2)

- the number of current reactor designs requires a selection of a **reference** for the investigations
- GRS chose **KERENA** (AREVA, Gen. III+ BWR of AREVA)
 - passive safety features can solely control DBA and BDA
 - access to design data of the passive components
 - for 25 years **component and integral tests** have been carried out



emergency and containment cooler tests at Forschungszentrum Jülich

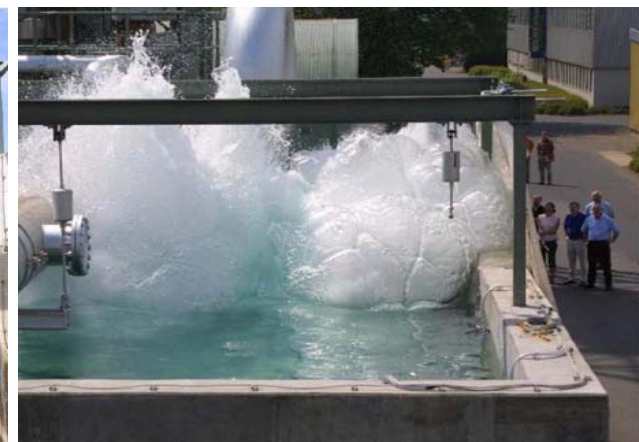

vent pipe tests at AREVA Technical Center Karlstein

Necessary TH improvements for AWCR (3)

- although the improvements are mainly related to the KERENA the work is of general interest for other NPP of Gen. III – IV, SMR
 - the operation principles (condensation / boiling) are similar
 - differences in dimensions, the materials and the special design features, initial and boundary conditions
 - better starting point for the investigation of other reactor (concepts)

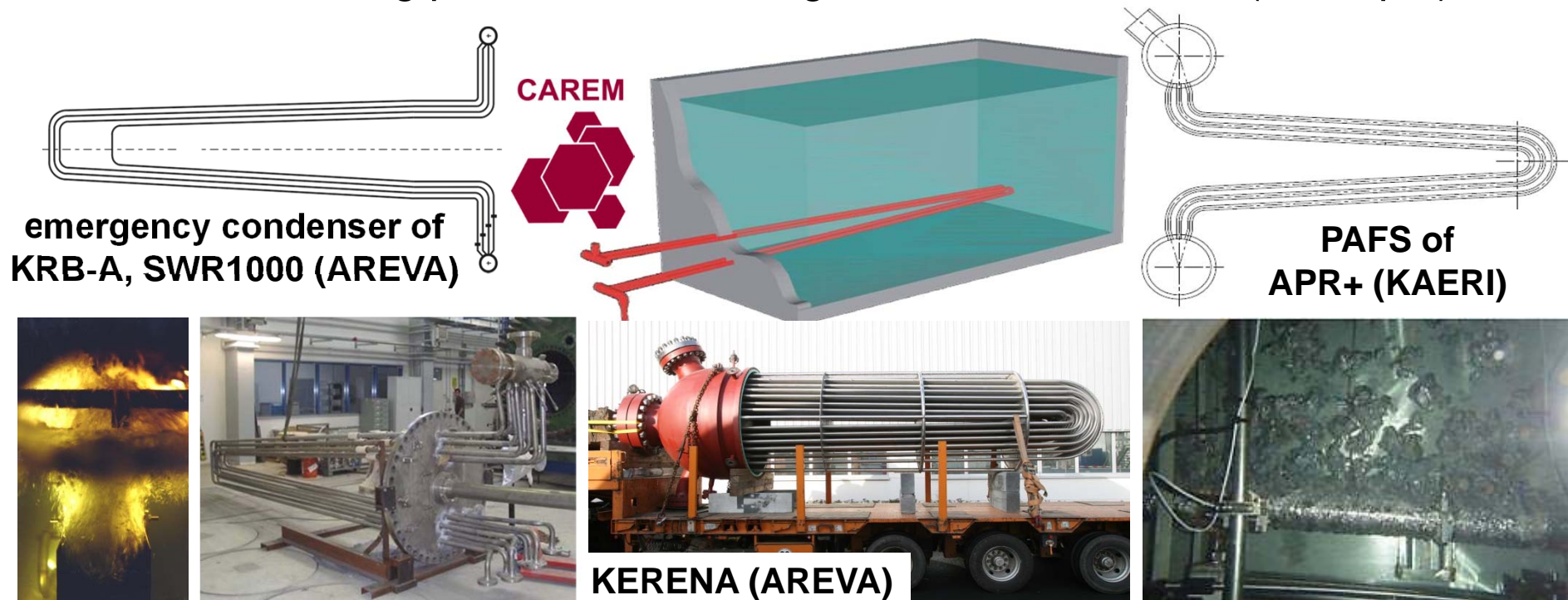

Small modular reactor (1)

- over 130 SMR are running e.g. ship propulsion, electricity and heat supply for remote areas (like the Arctic))
- over hundred new concepts are in development
- GRS study (in German), identifies general trends and new safety features:



- safety system relying on passive features (see slides 16 – 18)
- integrated, often self-pressurized cooling systems
- single / two phase natural convection (flow instabilities)
- innovative heat exchanger designs (helically coiled steam generators, plate heat exchangers), heat pipes
- exclusion of accidents (boron free core → no boron dilution accidents, natural circulation cooling → no failure of MCP)

May 2015

Studie zur Sicherheit
und zu internationalen
Entwicklungen von
Small Modular Reactors
(SMR)

Study of Safety and International Deve- lopment of SMR

[https://www.grs.de/
sites/default/files/
pdf/grs-376.pdf](https://www.grs.de/sites/default/files/pdf/grs-376.pdf)

GRS - 376

Small Modular Reactors (2)

- **infinite passive containment cooling** to an ultimate heat sink, (air or water) – HTC, flow fields
 - horizontally, vertically arranged containments in water pools
 - subsea-based containments
 - floating containments
 - heat pipes

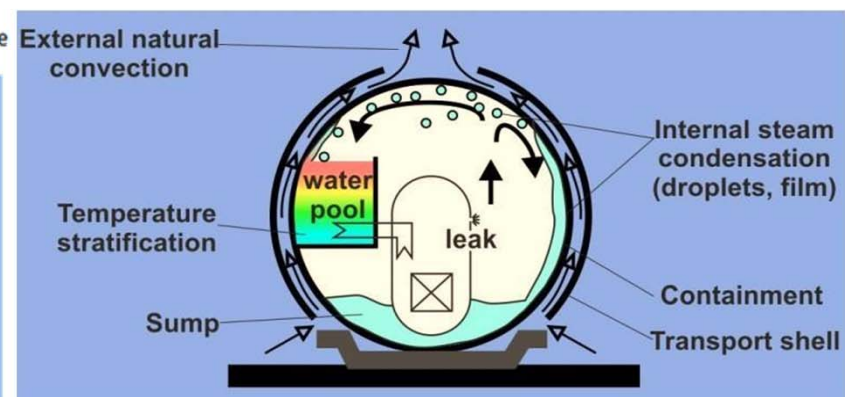
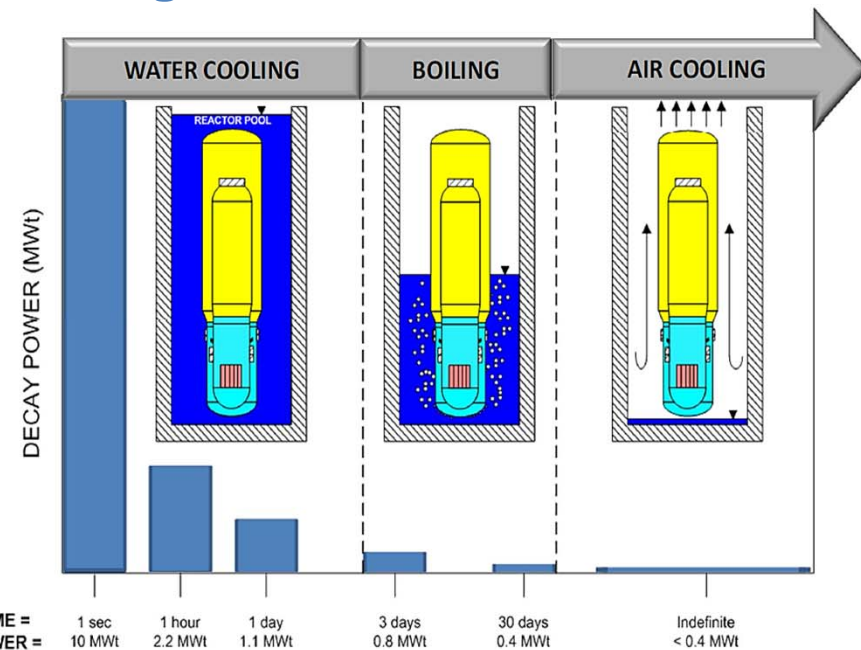
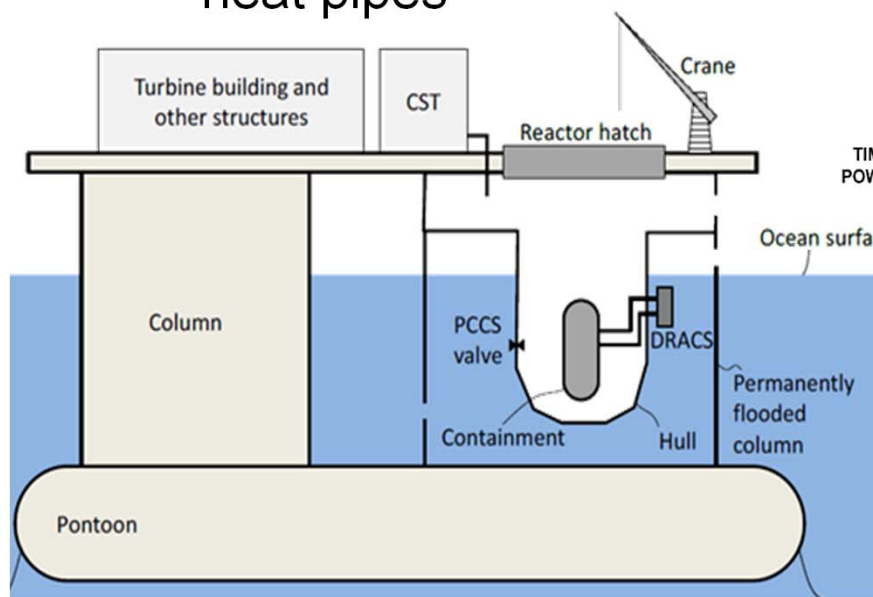

Summary and Outlook

- the German government decided to terminate the use of nuclear energy production
- at the same time the German government funds the (further) development and validation of the GRS nuclear simulation chain for the safety assessment e.g. of advanced water cooled reactors
- GRS has performed reviews to identify safety features, which are necessary for the simulation of AWCR (GRS *Study on Safety an International Development on SMR* in 2014 (GRS-376))
- the modelling gaps were identified and prioritized
- selected examples for necessary TH improvements were presented
- the work will be performed within national / international research projects (alliances)
- **in future GRS will have the necessary staff, competences, know-how and validated evidence tools for safety assessments also for Advanced Water Cooled Reactors**

Thank you very much for your attention!

Acknowledgement: The development of the GRS nuclear simulation chain is currently funded by the German Federal Ministry for Economic Affairs and Energy (BMWi) within several projects (essentially RS1507, RS1518, RS1520, RS1526, RS1532, RS1535, RS1538, RS1543, RS1546, RS1547).

Supported by:



on the basis of a decision
by the German Bundestag