

PADERNO®

WORLD CUISINE

PARTNER OF THE BEST CUISINE

# CATALOGUE 2021

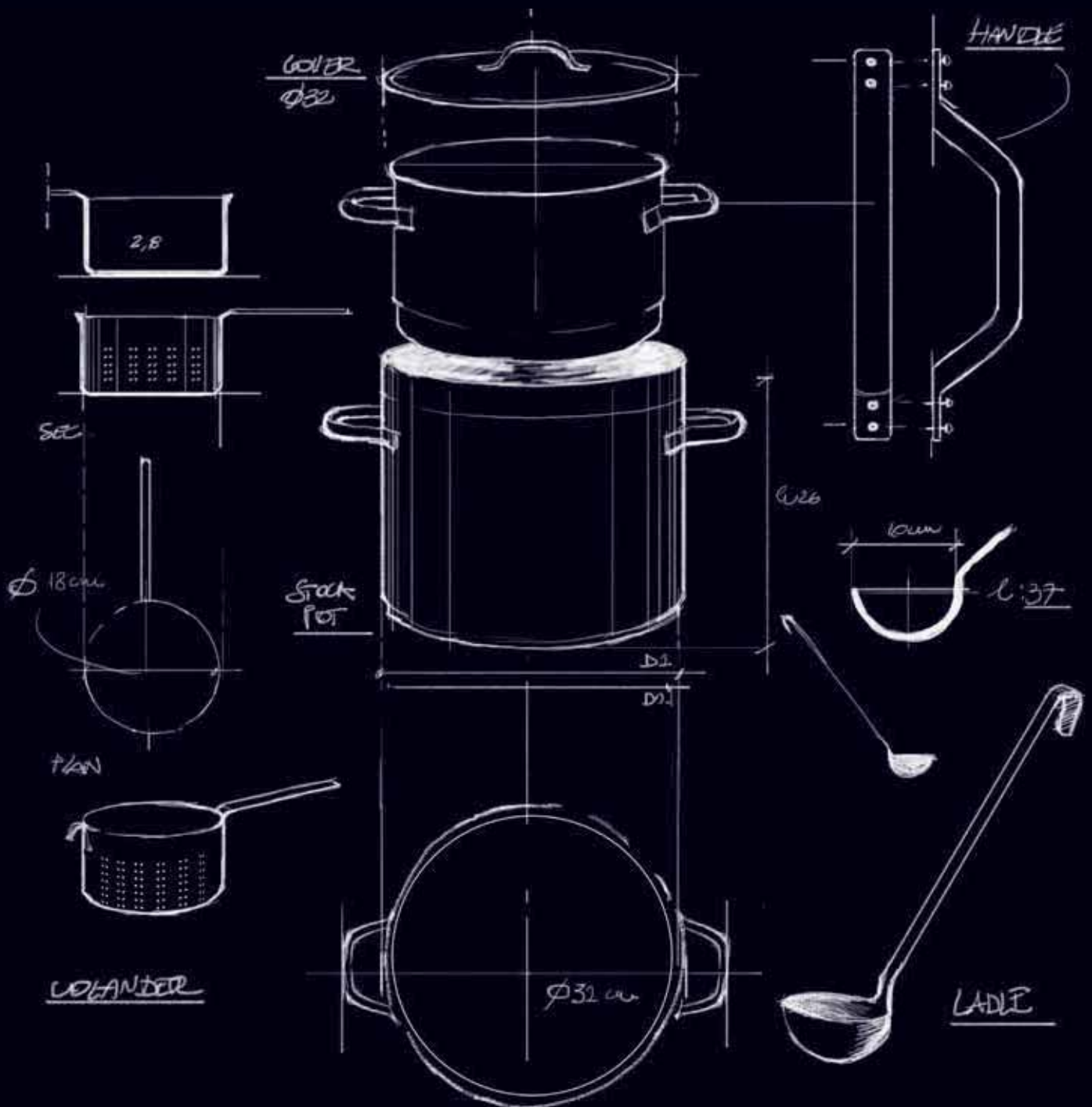



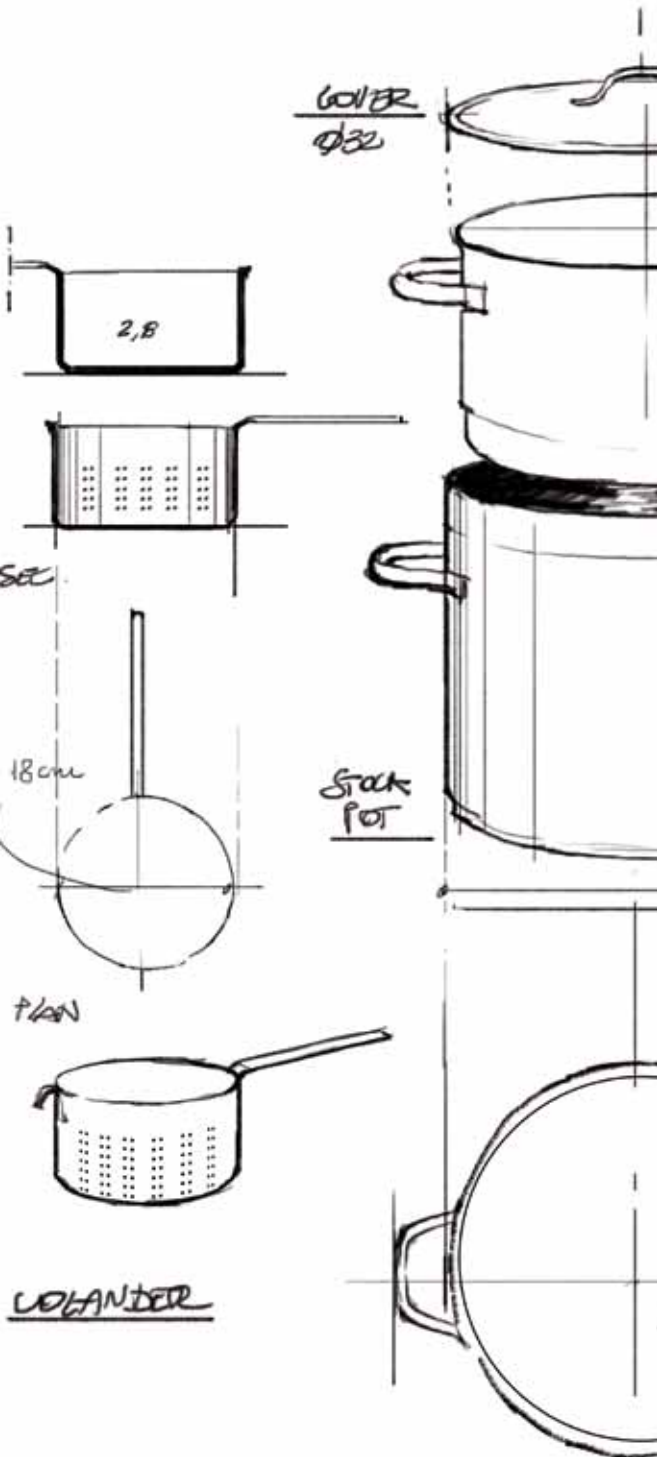

Dear partners,

despite the latest health emergency, we never stopped even during the lockdown and we never lost our optimism.

As proof of our commitment and confidence in the future, we proudly publish today the new edition of the Paderno catalogue, an essential tool for chefs and professionals. You will find a richer range of products and a review of prices in many categories, to present you an increasingly competitive and quality offer.

In recent months we have also worked to support all our clients through constant communication, strengthening our customer service and investing in the creation of further business opportunities, introducing for example new **drop shipment** solutions. Smart working and the most modern software infrastructures are the key points in our Digital Transformation process, that involves Paderno and all the brands of the Arcturus Group.

We are aware that especially in hard times it is important to be close to each other. That's why, today more than ever, we remain at your side.

Cari partner,

nonostante le difficoltà legate alla recente emergenza sanitaria, durante il periodo di lockdown non ci siamo mai fermati e non abbiamo mai perso l'ottimismo.

A testimonianza del nostro impegno e della fiducia che riponiamo nel futuro, è quindi con estremo orgoglio che pubblichiamo oggi la nuova edizione del catalogo Paderno, strumento indispensabile per gli chef e tutti i professionisti del mondo della ristorazione. Troverete una gamma di prodotti sempre più ricca e una revisione dei prezzi in molte categorie, così da presentarvi un'offerta sempre più competitiva e di qualità.

In questi mesi abbiamo inoltre lavorato per supportare tutti i nostri clienti attraverso una costante comunicazione, potenziando il nostro servizio di assistenza e investendo nella creazione di ulteriori opportunità commerciali, ad esempio introducendo nuove soluzioni di **drop shipment**. Smart working e le più moderne infrastrutture software sono i punti cardine nel nostro percorso di Digital Transformation per Arthur Krupp e tutti i marchi del gruppo Arcturus.

Siamo consapevoli che è proprio nei momenti di difficoltà che è importante esservi vicini. Ecco perché, oggi più che mai, restiamo al vostro fianco.

  
Giovanni Coppo  
Marketing Director

Sambonet Paderno Industrie SpA

# Factory

**A COMPLETE RANGE FOR EVERY NEED IN THE KITCHEN.  
MORE THAN 10.000 ITEMS DEDICATED TO CHEFS AND  
PASSIONATE GOURMANDS.**

From the cookware to the kitchen utensils, then knives, bakery items and tools for every kind of preparation, Paderno offers a complete selection for the best kitchens of houses and restaurants. A brand that finds its origins back in 1925 in Milan as "Alluminio Paderno", specializing in household cookware before it decided to focus on the professional cooking world. With over 90 years of history and a strong worldwide presence, Paderno is the premier choice for professionals in the catering sector. In addition to the production items, the brand offers a remarkable range of complementary articles, carefully selected and crafted by highly qualified companies.

**UNA GAMMA COMPLETA PER OGNI ESIGENZA IN CUCINA.  
OLTRE 10.000 ARTICOLI COMPONGONO L'OFFERTA  
DEDICATA A CHEF E APPASSIONATI GOURMET.**

Dal pentolame agli utensili cucina, passando per coltelli, articoli da pasticceria e strumenti per ogni tipo di preparazione, Paderno offre una selezione completa per le migliori cucine di case e ristoranti. Il Brand trova le sue origini nel 1925 nei pressi di Milano come Alluminio Paderno, specializzato nel settore della cucina casalinga per poi passare al settore professionale. Forte di oltre 90 anni di storia e di una presenza capillare in tutto il mondo, Paderno è il punto di riferimento per tutti i professionisti della ristorazione. Agli articoli di produzione il brand affianca un'importante gamma di prodotti complementari e affini, accuratamente selezionati e realizzati da ditte altamente qualificate.



## **Ho.Re.Ca.**

T 0321 19 16 601  
F 0321 19 16 890

[horeca@paderno.it](mailto:horeca@paderno.it)  
[horeca@sambonet.it](mailto:horeca@sambonet.it)

## **Retail**

T 0321 19 16 701  
F 0321 19 16 830

[retail.italia@sambonet.it](mailto:retail.italia@sambonet.it)  
[retail.international@sambonet.it](mailto:retail.international@sambonet.it)

## **Return**

T 0321 19 16 635 - 759

[returns@sambonet.it](mailto:returns@sambonet.it)

[www.paderno.it](http://www.paderno.it)  
[www.hotel.paderno.it](http://www.hotel.paderno.it)



# Green & Human

The respect for the environment and for the people is a relevant issue for Sambonet Paderno Industrie S.p.A. Corporate Responsibility. The commitment to sustainable growth on which the Group was founded has been maintained and permits both to guarantee adequate working conditions in order to satisfy the changing needs of the staff and to apply solutions aimed at reducing the environmental impact. From this perspective, the management of energy, electricity and water consumption focuses on:

- the use of electrical energy: clean, renewable and in harmony with the environment;
- the use of methane as the sole fuel source;
- the use of ground water for the manufacturing process, to be fully purified before being released into the environment;
- the use of an advanced energy-saving technology.

## Sustainability Report

Sambonet Paderno Industrie S.p.A. strives to implement forms of measurement to assess the punctuality, the transparency and the efforts made for sustainable development. This has led to the preparation of the corporate charter of principles, 10 principles, 10 commitments, on which the Company builds its industrial future from a perspective based on preventive approach and stewardship.

### Corporate Sustainability Report

[corporate.sambonet.it/csr.html](http://corporate.sambonet.it/csr.html)

The **UNI EN ISO 14001:2004** environmental certification is the recognition that the environmental policy results in a continuous improvement of environmental performance by minimising the negative impact of its operations on the environment.

The voluntary compliance with the standard **UNI EN ISO 50001:2011** demonstrates the company's commitment and vision towards responsible energy consumption, factoring in both the economic hope of reducing consumption and, above all, the desire to increase environmental awareness about reducing greenhouse gas emissions.

The **OHSAS 18001:2007** safety certification has the objective of protecting the safety of the workplace and the health of workers. Sambonet Paderno Industrie S.p.A. is the first Italian company in its sector that has obtained this certification.

## Social Responsibility

Sustainability, transparency and interaction with stakeholders are the integral components that the Corporate Social Responsibility policy of Sambonet Paderno Industries S.p.A. are comprised of.

The company's requirements, commitment and path taken in this area led it to obtain an SR10 certification in 2016 - the first in the sector. This important goal represents an objective guarantee in terms of attention in the interaction with stakeholders such as employees, customers, suppliers, local communities and associations in the area.

## WHP Health Promoting Workplace

This socially responsible role has recently prompted the company to join the European Network for Health Promoting Workplace (WHP), establishing itself as one of the pioneers of its territory. The project foresees that the company not only implements all the measures to prevent accidents and illnesses in the workplace but - and above all - that it also undertakes to offer its workers opportunities to improve their health, through the promotion of a wholesome lifestyle mentally, physically and emotionally.

Il rispetto dell'ambiente e della persona sono temi rilevanti all'interno della responsabilità d'impresa di Sambonet Paderno Industrie S.p.A. Il Gruppo ha impostato e sviluppa tutt'oggi la propria evoluzione con un impegno di crescita sostenibile garantendo condizioni lavorative che possano soddisfare i bisogni delle persone nei differenti momenti della loro vita aziendale e applicando soluzioni volte a diminuire l'impronta ecologica. In quest'ottica, la gestione dei consumi energetici, elettrici e idrici è orientata a:

- impiegare energia elettrica pulita e rinnovabile;
- utilizzare il metano come unica fonte di combustibile;
- servirsi, per la produzione, di acqua di falda da restituire all'ambiente completamente depurata;
- usare tecnologia di risparmio energetico avanzata.

Sambonet Paderno Industrie S.p.A. lavora per attuare forme di misurazione che siano in grado di documentare la puntualità, la trasparenza e l'impegno messo in atto per uno sviluppo sostenibile. Da qui la creazione della propria carta dei principi, 10 principi, 10 impegni su cui, attraverso un approccio preventivo e una gestione responsabile, l'Azienda costruisce il proprio futuro industriale.

### Bilancio di Sostenibilità dell'Azienda

[corporate.sambonet.it/csr.html](http://corporate.sambonet.it/csr.html)

**UNI EN ISO 14001:2004** La certificazione ambientale garantisce i risultati di una politica ambientale volta al continuo miglioramento delle proprie performance minimizzando ogni impatto negativo delle sue attività verso l'ambiente.

**UNI EN ISO 50001:2011** L'adesione volontaria alla norma UNI EN ISO 50001:2011 testimonia l'impegno e la visione dell'azienda verso l'ottimizzazione del consumo responsabile dell'energia, sia in termini economici auspicando a una riduzione dei consumi, e soprattutto verso una crescente attenzione ambientale diminuendo le emissioni di gas serra.

**OHSAS 18001:2007** La certificazione ha l'obiettivo di tutelare la sicurezza e la salute dei propri lavoratori e dell'ambiente lavorativo. Sambonet Paderno Industrie S.p.A. è la prima Azienda appartenente al settore metalmeccanico ad ottenere l'attestazione.

Sostenibilità, trasparenza e interazione con gli stakeholder sono le parole chiave della politica di Corporate Social Responsibility di Sambonet Paderno Industrie S.p.A..

I requisiti, l'impegno e il percorso intrapreso dall'azienda in questo ambito, l'ha portata nel 2016 - prima nel settore - a conseguire la certificazione SR10. Questo importante traguardo rappresenta una garanzia oggettiva in fatto di attenzione nell'interazione con gli stakeholder quali dipendenti, clienti, fornitori, comunità locali e associazioni sul territorio.

Questo ruolo socialmente responsabile ha recentemente spinto l'impresa ad aderire alla Rete Europea WHP (European Network for Health Promoting Workplace) affermandosi tra le pioniere del proprio territorio. Il progetto prevede che l'azienda non solo attui tutte le misure per prevenire infortuni e malattie sul luogo di lavoro ma - e soprattutto - che si impegni anche a offrire ai propri lavoratori opportunità per migliorare la propria salute, attraverso la promozione di uno stile di vita corretto in ambito alimentare, sportivo ed emotivo.

# Certifications

## UNI EN ISO 22000

Sambonet Paderno Industrie is the first company in its industry that has been awarded the EN UNI ISO 22000:2005 certification. This certification attests to the highest international standard both for the Group and for the whole food and beverage industry. The implementation of its requirements, along with the implementation of HACCP (Hazard Analysis and Critical Control Points, a hygiene system that prevents contamination hazards), ensures the provision of a safe and impeccable service to customers by meticulously and scrupulously assessing the hygienic and safety conditions of activities and products. This is a guarantee not only for HoReCa professionals, but also, and foremost, for final consumers.

## UNI EN ISO 9001:2015

This quality certification ensures compliance with the requirements of the international UNI EN ISO 9001:2008 standard, which guarantees the production and sale of products that fully meet customers' needs and expectations.

## NSF

Some products by Sambonet Paderno Industrie S.p.A. have obtained the prestigious NSF (National Sanitation Foundation) certification for compliance with the strict standards applied in the USA to materials in contact with foodstuffs. The NSF mark is a guarantee for manufacturers, inspectors and users.

## AEO

In 2008 Sambonet Paderno Industrie S.p.A. obtained the AEO Certification for Customs Simplifications and Security and Safety, valid for the EU. This programme provides a framework for governing customs regulations, guaranteeing that the company provides a reliable and secure service within the international supply chain. In addition, in 2011, Sambonet Paderno Industrie S.p.A. obtained the mutual recognition of the AEO programme with the Japanese customs administration, thus further improving customs relations with Japan.

## KNOWN CONSIGNOR

The "Known Consignor" approval issued by ENAC (Italian Civil Aviation Authority) certifies that the company is an originator of cargo suitable for carriage on any aircraft, in compliance with common safety procedures and provisions.

## ECCELLENZA 2006

This prestigious certificate of Excellence, awarded by Certiquality to Sambonet Paderno Industrie S.p.A. for the implementation of an integrated Quality, Environmental and Safety management system, has been granted only to few companies in Italy that have obtained the ISO 9001, ISO 14001 and BS OHSAS 18001 certifications.

## AWARD FOR EXCELLENCE

In 2006 Sambonet Paderno Industrie S.p.A. received the Award for Excellence for Innovation by Confindustria (the main organization representing Italian manufacturing and services companies) with reference to the framework for innovation of the EFQM—European Foundation for Quality Management.

## UNI EN ISO 22000

Prima nel suo settore Sambonet Paderno Industrie S.p.A. ha ottenuto la certificazione EN UNI ISO 22000:2005. Così come per l'intero comparto food and beverage, anche per il Gruppo la UNI EN ISO 22000:2005 rappresenta lo standard di più alto livello su scala internazionale. L'applicazione dei suoi requisiti, congiuntamente all'applicazione dell'HACCP (Hazard Analysis and Critical Control Points, sistema di autocontrollo igienico che previene i pericoli di contaminazione), garantisce alla clientela un servizio sicuro ed impeccabile attraverso una valutazione puntuale e scrupolosa delle condizioni igieniche e sanitarie delle attività e dei prodotti. Una garanzia di tutela non solo per il personale del canale professionale ma anche, e soprattutto, per il consumatore finale.

## UNI EN ISO 9001:2015

La certificazione di qualità conforme ai requisiti della normativa internazionale garantisce la produzione e la commercializzazione di prodotti che soddisfino pienamente i requisiti e le aspettative del cliente.

## NSF

La certificazione è stata conseguita per alcuni prodotti grazie al superamento delle rigorose norme applicate negli USA circa i materiali a contatto con gli alimenti. Il marchio NSF (National Sanitation Foundation) è sinonimo di garanzia per i costruttori, ispettori ed utilizzatori.

## AEO

La certificazione comunitaria AEO Semplificazioni doganali e Sicurezza, conseguita nel 2008, garantisce un'attività disciplinata della regolamentazione doganale dell'azienda qualificandola in fatto di affidabilità e sicurezza nella catena di approvvigionamento internazionale. Nel 2011, inoltre, Sambonet Paderno Industrie S.p.A. ha ottenuto il mutuo riconoscimento del programma AEO con l'amministrazione doganale giapponese, condizione che favorisce ulteriormente i rapporti con il paese.

## MITTENTE CONOSCIUTO

L'approvazione "Mittente Conosciuto" rilasciata da ENAC (Ente Nazionale Aviazione Civile) riconosce l'Azienda come sito d'origine di merce idonea al trasporto su aeromobili di qualsiasi tipo, in conformità alle procedure e disposizioni comuni di sicurezza.

## ECCELLENZA 2006

Certiquality ha attribuito a Sambonet Paderno Industrie S.p.A. il Certificato di Eccellenza per aver implementato un sistema di gestione integrata di Qualità, Ambiente e Sicurezza. L'ambito riconoscimento è ottenuto da poche aziende in Italia certificate ISO 9001, ISO 14001 e BS OHSAS 18001.

## AWARD FOR EXCELLENCE

Nel 2006 Sambonet Paderno Industrie S.p.A. è stata insignita dell'Award for Excellence per l'innovazione, rilasciato da Confindustria in riferimento al framework per l'innovazione dell'EFQM—European Foundation for Quality Management.



# ASEC<sup>LAB</sup>

ALIMENTARY  
SECURITY  
CONTROL  
LABORATORY



ASECLAB1@SAMBONET.IT



LABORATORIO DI ANALISI  
INTERNO CERTIFICATO



LAB N°1407

The items produced and sold by Sambonet Paderno Industrie S.p.A. not only comply with applicable regulations, but are also systematically tested. The Company can guarantee the suitability and safety of its products as it has established a specific workgroup and the ASEC Lab (Alimentary Security Control) internal laboratory, which analyses the materials intended to come into contact with foodstuffs. The laboratory is now accredited to carry out migration testing on steel, aluminum, porcelain, glass, entirely plastic materials and coloring in order to issue declarations of compliance, recognized by both national and international governments. The ASEC Lab is also accredited to determine pH levels, solvents and metals in water discharge, a guarantee for the internal analysis of the wastewater quality.

Oltre alla conformità rispetto alle norme vigenti, gli articoli prodotti e commercializzati da Sambonet Paderno Industrie S.p.A. sono controllati in maniera sistematica. Grazie alla costituzione di un gruppo di lavoro e del laboratorio interno ASEC Lab (Alimentary Security Control), specializzato nell'analisi di materiali destinati al contatto con gli alimenti, l'Azienda è in grado di garantire l'idoneità e la sicurezza dei propri prodotti. Il laboratorio è oggi accreditato per realizzare internamente test di migrazione su acciaio, alluminio, porcellana, vetro, materiali plastici e coloranti per il rilascio di dichiarazioni di conformità, riconosciute da qualsiasi ente nazionale e internazionale. ASEC Lab è inoltre accreditato per la determinazione di pH, solventi e metalli nelle acque scarico, una garanzia per le analisi interne sulla qualità delle proprie acque di scarico.



Pentolame  
Cookware, pots & pans  
Kochgeschirr  
Batteries de cuisine  
Baterías de cocina

## 10



GN food pans  
Contenitori GN  
GN-Behälter  
Bacs GN  
Cubetas GN

## 51



Kitchen utensils  
Utensili da cucina  
Küchenzubehöre  
Ustensiles de cuisine  
Utensilios de cocina

## 78



Knives  
Coltelleria  
Kochmesser  
Coutellerie  
Cuchilleria

## 137



Pastry utensils  
Pasticceria  
Konditorei-Artikel  
La pâtisserie  
Pastelería

## 170



Ethnic cuisine  
Cucina etnica  
Ethnische Küche  
Cuisine ethnique  
Cocina étnica

## 256





Bar & Ice-Cream  
Bar e gelateria  
Bar u. Eis-Artikel  
Bar et glace  
Bar y heladería

## 283



Table top service  
Tavola  
Tischservice  
Service de table  
Servicio de mesa

## 345



Buffet display and presentation  
Buffet e presentazione  
Buffet und Präsentation  
Buffet et présentation  
Presentación de buffet

## 393



Chafing dishes / Trolleys  
Scaldavivande / Carrelli sala  
Chafing dishes / Servicewagen  
Chafing dishes / Chariots  
Chafing dishes / Carros

## 436



Storage, transport, cleaning  
Stoccaggio, trasporto, pulizia  
Lagerung, Transport, Reinigung  
Stockage, transport, nettoyage  
Almacenamiento, transporte, limpieza

## 459

































Electric appliances  
Apparecchi elettrici  
Elektrogeräte  
Appareils électriques  
Aparatos eléctricos









## 497



## ICONS - SIMBOLOGIA - SYMBOLE - SYMBOLES - ICONOS

|  |   |   |   |
|--|---|---|---|
|  <b>ABS</b>           | Copolymer, acrylonitrile-butadiene-styrene<br>Copolimero, acrilonitrile-butadiene-stirene |  <b>PA+</b><br><i>plus</i> | Polyamide (nylon 6.6) with fiberglass<br>Poliammide (nylon 6.6) con fibra di vetro    |
|  <b>AG</b>            | Silverplated<br>Argentato   |  <b>PR</b>                 | Porcelain<br>Porcellana   |
|  <b>AQ</b><br>PVD     | Antique PVD   |  <b>PC</b>                 | Polycarbonate<br>Policarbonato  |
|  <b>AR</b>            | Natural slate<br>Ardesia naturale   |  <b>PE</b>                 | Polyethylene<br>Polietilene   |
|  <b>AY</b>            | Acrylic<br>Acrilico   |  <b>PMMA</b>               | Polymethylmethacrylate, plexiglass<br>Polimetilmetacrilato, plexiglas                 |
|  <b>B</b>             | Bamboo  |  <b>PPE</b>                | Phenylene ether-expanded polypropylene<br>Etere di polifenilene-polipropilene espanso |
|  <b>BC</b>          | Bone china  |  <b>PP</b>               | Polypropylene<br>Polipropilene  |
|  <b>BPA</b><br>FREE | Without bisphenol A<br>Senza bisfenolo A  |  <b>PS</b>               | Polystyrene<br>Polistirene/polistirolo  |
|  <b>FE</b>          | Metal<br>Metallo  |  <b>PVD</b>              | Physical vapor deposition<br>Deposizione fisica da vapore                             |
|  <b>HDPE</b>        | High-density polyethylene<br>Polietilene ad alta densità                                  |  <b>R</b>                | Natural rattan<br>Rattan naturale   |
|  <b>MF</b>          | Melamine<br>Melamina  |  <b>SAN</b>              | Acrylonitrile-styrene copolymer<br>Copolimero acrilonitrile-stirene                   |
|  <b>MS</b>          | Methylstyrene<br>Metilstirene   |  <b>SS</b>               | Stainless steel<br>Acciaio inox   |
|  <b>NEW</b>         | New<br>Novità   |  <b>VG</b>               | Vintage   |
|  <b>NSF</b>         | NSF certified<br>Certificato NSF  |  <b>VG</b><br>PVD        | Vintage PVD   |
|  <b>PA</b>          | Polyamide (nylon)<br>Poliammide (nylon)   |  <b>W</b>                | Wood<br>Legno   |

# ICONS - SIMBOLOGIA - SYMBOLE - SYMBOLES - ICONOS

|   |   |   |  |
|---|---|---|--|
|    | Suitable for electric stoves<br>Adatto per fornelli elettrici             |    | GN size<br>Misure GN   |
|    | Suitable for glass-ceramic stoves<br>Adatto per fornelli in vitroceramica |    | Battery powered<br>Alimentato a batterie                     |
|    | Suitable for induction stoves<br>Adatto per fornelli a induzione          |    | Hand wash<br>Lavare a mano                                   |
|    | Suitable for gas stoves<br>Adatto per fornelli a gas                      |    | Do not use sharp objects<br>Non usare oggetti taglienti      |
|    | For gluten free food<br>Per alimenti senza glutine                        |    | Do not use on open flames<br>Non utilizzare su fiamme libere |
|    | Cooling<br>Refrigerabile  |    | Dishwasher safe<br>Lavabile in lavastoviglie                 |
|    | Heated<br>Riscaldato  |    | No dishwasher safe<br>Non lavabile in lavastoviglie          |
|    | Water resistant<br>Resistente all'acqua                                   |    | Microwave safe<br>Idoneo a microonde                         |
|  | NO water resistant<br>NON resistente all'acqua                            |  | Oven safe<br>Idoneo a forno                                  |
|  | With light<br>Con luce  |  | No microwave safe<br>Non idoneo a microonde                  |
|  | Food safe<br>Per alimenti   |  | No oven safe<br>Non idoneo a forno                           |
|  | Stackable<br>Impilabile   |   |  |

Product list # Gluten Free - Spare parts  
Elenco prodotti Gluten Free - Ricambi  
Glutenfrei-Produktliste - Ersatzteile  
Liste produits Gluten Free - Pièces de rechange  
Lista productos Gluten Free - Repuestos

## 521



Index and sales terms  
Indice e condizioni di vendita  
Index und Verkaufsbedingungen  
Index et conditions de vente  
Índice y condiciones de venta

## 534





# SERIES 1100

STAINLESS STEEL COOKWARE  
PENTOLAME INOX



Outside and inside satin polished. Top edges mirror polished. Hollow tubular stay cool handles in stainless steel, ergonomically shaped. Extra thick edges. Double thick bottom. Sandwich thermoradiant bottom (stainless steel-aluminum-stainless steel). Concave bottom when cold and flat when hot (100% heat exploiting). Perfect for use on any type of stove, whether gas, electric, glass ceramic cooking surface or induction stove. All items have an induction suited sandwich bottom.

Finitura esterna ed interna satinata, bordo lucido. Manicatura tubolare in acciaio inox, anatomica, resistente al calore. Bordo rinforzato. Doppio spessore del fondo. Fondo termodiffusore sandwich (inox-alluminio-inox). Concavo a freddo e piano a caldo (sfruttamento del calore al 100%). Ideali per ogni tipo di cottura, gas, elettrica, vetroceramica e induzione. Tutti gli articoli sono dotati di speciale fondo termodiffusore adatto anche per piastre ad induzione.



NSF

**Stock pot**  
Pentola  
Hoher Suppentopf  
Marmite traiteur  
Olla recta

| art.     | Ø cm. | h. | lt.   |
|----------|-------|----|-------|
| 11101-16 | 16    | 16 | 3,2   |
| 11101-20 | 20    | 20 | 6,2   |
| 11101-24 | 24    | 24 | 10,0  |
| 11101-28 | 28    | 28 | 16,5  |
| 11101-32 | 32    | 32 | 24,0  |
| 11101-36 | 36    | 36 | 36,0  |
| 11101-40 | 40    | 40 | 50,0  |
| 11101-45 | 45    | 45 | 70,0  |
| 11101-50 | 50    | 50 | 100,0 |



NSF

**Low stock pot**  
Pentola bassa  
Gemüsetopf  
Faitout  
Olla recta baja

| art.     | Ø cm. | h. | lt.  |
|----------|-------|----|------|
| 11105-16 | 16    | 14 | 2,7  |
| 11105-20 | 20    | 17 | 5,0  |
| 11105-24 | 24    | 21 | 8,5  |
| 11105-28 | 28    | 23 | 14,5 |
| 11105-32 | 32    | 26 | 22,0 |
| 11105-36 | 36    | 28 | 29,0 |
| 11105-40 | 40    | 32 | 40,0 |



NSF

**Saucepot**  
Casseruola alta  
Fleischtopf  
Brasière  
Cacerola alta

| art.     | Ø cm. | h.   | lt.  |
|----------|-------|------|------|
| 11107-16 | 16    | 11,0 | 2,1  |
| 11107-20 | 20    | 13,0 | 4,0  |
| 11107-24 | 24    | 15,0 | 6,5  |
| 11107-28 | 28    | 17,5 | 10,8 |
| 11107-32 | 32    | 19,5 | 15,7 |
| 11107-36 | 36    | 21,5 | 22,0 |
| 11107-40 | 40    | 24,5 | 30,8 |
| 11107-45 | 45    | 27,5 | 44,0 |
| 11107-50 | 50    | 32,0 | 63,0 |



NSF

**Casserole pot**  
Casseruola bassa  
Bratentopf  
Sautoir  
Cacerola baja

| art.     | Ø cm. | h.   | lt.  |
|----------|-------|------|------|
| 11109-16 | 16    | 7,5  | 1,3  |
| 11109-20 | 20    | 8,0  | 2,5  |
| 11109-24 | 24    | 9,5  | 4,3  |
| 11109-28 | 28    | 11,0 | 6,7  |
| 11109-32 | 32    | 12,5 | 10,0 |
| 11109-36 | 36    | 14,0 | 14,2 |
| 11109-40 | 40    | 15,5 | 19,5 |
| 11109-45 | 45    | 17,0 | 27,0 |
| 11109-50 | 50    | 19,0 | 37,0 |



NSF

**Colander for stock pot**  
Colapasta per pentola  
Seiher für Suppentopf  
Passoire pour marmite  
Colador para olla recta

| art.     | Ø cm. | h.   |
|----------|-------|------|
| 11123-20 | 20    | 22,0 |
| 11123-24 | 24    | 26,5 |
| 11123-28 | 28    | 29,5 |

Suitable for both item 11105 and 11101.  
Per art. 11105 e art. 11101.



NSF

**Stock pot with tap**  
Pentola con rubinetto  
Hochtopf mit Hahn  
Marmite avec robinet  
Olla con grifo

| art.     | Ø cm. | h. | lt.   |
|----------|-------|----|-------|
| 11102-28 | 28    | 28 | 16,5  |
| 11102-32 | 32    | 32 | 24,0  |
| 11102-36 | 36    | 36 | 36,0  |
| 11102-40 | 40    | 40 | 50,0  |
| 11102-45 | 45    | 45 | 70,0  |
| 11102-50 | 50    | 50 | 100,0 |



NSF

**Steamer pot, perforated bottom**  
Inserto a vapore, fondo forato  
Dampf-Siebeinsatz  
Casserole à vapeur, perforée  
Cacerola base perforada

| art.     | Ø cm. | h.   |
|----------|-------|------|
| 11119-20 | 20    | 12,5 |
| 11119-24 | 24    | 15,0 |
| 11119-28 | 28    | 17,0 |
| 11119-32 | 32    | 19,0 |



NSF

**Saucepan**  
Casseruola alta  
Stielkasserolle, hoch  
Casserole haute  
Cazo recto alto

| art.      | Ø cm. | h.   | lt.  |
|-----------|-------|------|------|
| 11106-14  | 14    | 8,0  | 1,2  |
| 11106-16  | 16    | 11,0 | 2,1  |
| 11106-20  | 20    | 13,0 | 4,0  |
| 11106-24  | 24    | 15,0 | 6,5  |
| 11106-28* | 28    | 17,5 | 10,8 |
| 11106-32* | 32    | 19,5 | 15,7 |
| 11106-36* | 36    | 21,5 | 22,0 |

\*With loop handle. – Con contromaniglia.



**Sauté pan**

Casseruola bassa  
Stielkasserolle, niedrig  
Plat à sauter

**Cazo recto bajo**

| art.      | Ø cm. | h.   | lt.  |
|-----------|-------|------|------|
| 11108-16  | 16    | 6,5  | 1,3  |
| 11108-20  | 20    | 8,0  | 2,5  |
| 11108-24  | 24    | 9,5  | 4,3  |
| 11108-28* | 28    | 11,0 | 6,7  |
| 11108-32* | 32    | 12,5 | 10,0 |
| 11108-36* | 36    | 14,0 | 14,2 |

\*With loop handle. – Con contromaniglia.



**Sauté pan**

Casseruola conica  
Sauteuse  
Sauteuse

**Cazo cónico**

| art.     | Ø cm. | h.  | lt. |
|----------|-------|-----|-----|
| 11112-16 | 16    | 6,0 | 1,0 |
| 11112-18 | 18    | 6,0 | 1,2 |
| 11112-20 | 20    | 6,5 | 1,6 |
| 11112-24 | 24    | 7,5 | 2,7 |



**Curved sauté pan**

Casseruola "bombé"  
Sauteuse mit Schüttrand  
Sauteuse bombé

**Cazo bombeado**

| art.     | Ø cm. | h.  | lt. |
|----------|-------|-----|-----|
| 11113-18 | 18    | 7,0 | 1,7 |
| 11113-20 | 20    | 7,5 | 2,2 |
| 11113-24 | 24    | 8,5 | 3,3 |
| 11113-26 | 26    | 9,0 | 4,2 |



**Frypan**

Padella  
Bratpfanne  
Poêle à frire  
Sartén

| art.      | Ø cm. | h.  |
|-----------|-------|-----|
| 11114-20  | 20    | 5,0 |
| 11114-24  | 24    | 5,0 |
| 11114-28  | 28    | 5,5 |
| 11114-32  | 32    | 6,0 |
| 11114-36* | 36    | 6,0 |
| 11114-40* | 40    | 6,0 |
| 11114-45* | 45    | 6,5 |

\*With loop handle. – Con contromaniglia.



**Frypan, non stick coating**

Padella, antiaderente  
Bratpfanne mit Antihftbeschichtung  
Poêle avec revêtement anti-adhésif  
Sartén antiaderente

| art.     | Ø cm. | h.  |
|----------|-------|-----|
| 11117-20 | 20    | 5,0 |
| 11117-24 | 24    | 5,0 |
| 11117-28 | 28    | 5,5 |
| 11117-32 | 32    | 6,0 |
| 11117-36 | 36    | 6,0 |
| 11117-40 | 40    | 6,0 |



**French omelet pan**

Tegame  
Servierpfanne  
Poêle à paella  
Paellera

| art.     | Ø cm. | h.  |
|----------|-------|-----|
| 11115-20 | 20    | 5,0 |
| 11115-24 | 24    | 5,0 |
| 11115-28 | 28    | 5,5 |
| 11115-32 | 32    | 6,0 |
| 11115-36 | 36    | 6,0 |
| 11115-40 | 40    | 6,0 |
| 11115-45 | 45    | 6,5 |
| 11115-50 | 50    | 8,0 |



**Cover, reinforced edge**

Coperchio, bordo rinforzato  
Deckel mit Randverstärkung  
Couvercle, bord renforcé  
Tapa, borde reforzado

| art.     | Ø cm. |
|----------|-------|
| 11161-12 | 12    |
| 11161-14 | 14    |
| 11161-16 | 16    |
| 11161-18 | 18    |
| 11161-20 | 20    |
| 11161-22 | 22    |
| 11161-24 | 24    |
| 11161-28 | 28    |
| 11161-32 | 32    |
| 11161-36 | 36    |
| 11161-40 | 40    |
| 11161-45 | 45    |
| 11161-50 | 50    |
| 11161-60 | 60    |





# SERIES 2100

STAINLESS STEEL COOKWARE  
PENTOLAME INOX



The serie 2100 has the same characteristics of the serie 1100. It varies only for the shape of the handles of 2 handles items. Perfect for use on any type of stove, whether gas, electric, glass ceramic cooking surface or induction stove. All items have an induction suited sandwich bottom.

La serie 2100 ha le stesse caratteristiche della serie 1100. Differisce solo per una diversa manicatura sugli articoli a 2 maniglie. Ideali per ogni tipo di cottura, gas, elettrica, vetroceramica e induzione. Tutti gli articoli sono dotati di speciale fondo termodiffusore adatto anche per piastre ad induzione.



**Stock pot**  
Pentola  
Hoher Suppentopf  
Marmite traiteur  
Olla recta

| art.     | Ø cm. | h. | lt.   |
|----------|-------|----|-------|
| 12101-16 | 16    | 16 | 3,2   |
| 12101-20 | 20    | 20 | 6,2   |
| 12101-24 | 24    | 24 | 10,0  |
| 12101-28 | 28    | 28 | 16,5  |
| 12101-32 | 32    | 32 | 24,0  |
| 12101-36 | 36    | 36 | 36,0  |
| 12101-40 | 40    | 40 | 50,0  |
| 12101-45 | 45    | 45 | 70,0  |
| 12101-50 | 50    | 50 | 100,0 |



**Saucepot**  
Casseruola alta  
Fleischtopf  
Brasière  
Cacerola alta

| art.     | Ø cm. | h.   | lt.  |
|----------|-------|------|------|
| 12107-16 | 16    | 11,0 | 2,1  |
| 12107-20 | 20    | 13,0 | 4,0  |
| 12107-24 | 24    | 15,0 | 6,5  |
| 12107-28 | 28    | 17,5 | 10,8 |
| 12107-32 | 32    | 19,5 | 15,7 |
| 12107-36 | 36    | 21,5 | 22,0 |
| 12107-40 | 40    | 24,5 | 30,8 |
| 12107-45 | 45    | 27,5 | 44,0 |
| 12107-50 | 50    | 32,0 | 63,0 |



**Casserole pot**  
Casseruola bassa  
Bratentopf  
Sautoir  
Cacerola baja

| art.     | Ø cm. | h.   | lt.  |
|----------|-------|------|------|
| 12109-16 | 16    | 7,5  | 1,3  |
| 12109-20 | 20    | 8,0  | 2,5  |
| 12109-24 | 24    | 9,5  | 4,3  |
| 12109-28 | 28    | 11,0 | 6,7  |
| 12109-32 | 32    | 12,5 | 10,0 |
| 12109-36 | 36    | 14,0 | 14,2 |
| 12109-40 | 40    | 15,5 | 19,5 |
| 12109-45 | 45    | 17,0 | 27,0 |
| 12109-50 | 50    | 19,0 | 37,0 |



# SERIES 1000

STAINLESS STEEL COOKWARE  
PENTOLAME INOX



Outside and inside satin polished. Non-drip edge. Hollow tubular stay cool handles in stainless steel, ergonomically shaped. Uniform thickness in sides and bottoms. Sandwich thermoradiant bottom (stainless steel-aluminum-stainless steel). Concave bottom when cold and flat when hot (100% heat exploiting). Perfect for use on any type of stove, whether gas, electric, glass ceramic cooking surface or induction stove. All items have an induction suited sandwich bottom.

Finitura esterna ed interna satinata. Bordo a versare. Manicatura tubolare in acciaio inox, anatomica, resistente al calore. Parete e fondo a spessore uniforme. Fondo termodiffusore sandwich (inox-alluminio-inox). Concavo a freddo e piano a caldo (sfruttamento del calore al 100%). Ideali per ogni tipo di cottura, gas, elettrica, vetroceramica e induzione. Tutti gli articoli sono dotati di speciale fondo termodiffusore adatto anche per piastre ad induzione.





**Stock pot**  
Pentola  
Hoher Suppentopf  
Marmite traiteur  
Olla recta

| art.     | Ø cm. | h.   | lt.   |
|----------|-------|------|-------|
| 11001-16 | 16    | 16,0 | 3,2   |
| 11001-18 | 18    | 16,0 | 4,0   |
| 11001-20 | 20    | 18,0 | 5,5   |
| 11001-22 | 22    | 22,0 | 8,3   |
| 11001-24 | 24    | 24,0 | 10,5  |
| 11001-28 | 28    | 28,0 | 17,0  |
| 11001-32 | 32    | 27,5 | 20,4  |
| 11001-36 | 36    | 36,0 | 36,5  |
| 11001-40 | 40    | 40,0 | 50,0  |
| 11001-45 | 45    | 40,0 | 63,5  |
| 11001-50 | 50    | 50,0 | 98,0  |
| 11001-60 | 60    | 55,0 | 150,0 |



**Saucepot**  
Casseruola alta  
Fleischtopf  
Brasière  
Cacerola alta

| art.     | Ø cm. | h.   | lt.  |
|----------|-------|------|------|
| 11007-16 | 16    | 9,5  | 1,9  |
| 11007-18 | 18    | 10,8 | 2,7  |
| 11007-20 | 20    | 12,0 | 3,8  |
| 11007-22 | 22    | 13,0 | 5,0  |
| 11007-24 | 24    | 14,5 | 6,5  |
| 11007-28 | 28    | 16,0 | 9,8  |
| 11007-32 | 32    | 19,5 | 15,4 |
| 11007-36 | 36    | 21,5 | 20,5 |
| 11007-40 | 40    | 24,0 | 30,1 |
| 11007-45 | 45    | 27,0 | 42,9 |
| 11007-50 | 50    | 30,0 | 58,0 |
| 11007-60 | 60    | 35,0 | 99,0 |



**Casserole pot**  
Casseruola bassa  
Bratentopf  
Sautoir  
Cacerola baja

| art.     | Ø cm. | h.   | lt.  |
|----------|-------|------|------|
| 11009-16 | 16    | 6,5  | 1,3  |
| 11009-18 | 18    | 7,0  | 1,8  |
| 11009-20 | 20    | 7,5  | 2,5  |
| 11009-24 | 24    | 8,0  | 3,7  |
| 11009-28 | 28    | 9,5  | 5,8  |
| 11009-32 | 32    | 11,0 | 9,2  |
| 11009-36 | 36    | 13,0 | 13,0 |
| 11009-40 | 40    | 14,5 | 18,0 |
| 11009-45 | 45    | 15,5 | 24,6 |
| 11009-50 | 50    | 19,0 | 37,0 |
| 11009-60 | 60    | 25,0 | 70,7 |



**Saucepan**  
Casseruola mezza alta  
Bratentopf, mittelhoch  
Casserole  
Cacerola francés

| art.     | Ø cm. | h. | lt. |
|----------|-------|----|-----|
| 11010-16 | 16    | 8  | 1,6 |
| 11010-18 | 18    | 9  | 2,3 |
| 11010-20 | 20    | 10 | 3,1 |
| 11010-24 | 24    | 12 | 5,4 |



**Sauté pan**  
Casseruola conica  
Sauteuse  
Sauteuse  
Cazo cónico

| art.     | Ø cm. | h.  | lt. |
|----------|-------|-----|-----|
| 11012-16 | 16    | 6,0 | 1,0 |
| 11012-18 | 18    | 6,0 | 1,2 |
| 11012-20 | 20    | 6,5 | 1,6 |
| 11012-24 | 24    | 7,5 | 2,7 |



**Curved sauté pan**  
Casseruola bombé  
Sauteuse mit Schüttrand  
Sauteuse bombé  
Cazo bombeado

| art.     | Ø cm. | h.  | lt. |
|----------|-------|-----|-----|
| 11013-18 | 18    | 7,0 | 1,7 |
| 11013-20 | 20    | 7,5 | 2,2 |
| 11013-24 | 24    | 8,5 | 3,3 |
| 11013-26 | 26    | 9,0 | 4,2 |





**Saucepan**

Casseruola alta  
Stielkasserolle, hoch  
Casserole haute  
Cazo recto alto

| art.      | Ø cm. | h.   | lt.  |
|-----------|-------|------|------|
| 11006-12  | 12    | 7,0  | 0,8  |
| 11006-14  | 14    | 8,0  | 1,2  |
| 11006-16  | 16    | 9,5  | 1,9  |
| 11006-18  | 18    | 10,8 | 2,7  |
| 11006-20  | 20    | 12,0 | 3,8  |
| 11006-22  | 22    | 13,0 | 5,0  |
| 11006-24  | 24    | 14,5 | 6,5  |
| 11006-28* | 28    | 16,0 | 9,8  |
| 11006-32* | 32    | 19,5 | 15,4 |
| 11006-36* | 36    | 21,5 | 20,5 |

\*With loop handle. – Con contromaniglia.



**Saucepan**

Casseruola mezza alta  
Stielkasserolle, mittelhoch  
Casserole  
Cazo recto francés

| art.     | Ø cm. | h. | lt. |
|----------|-------|----|-----|
| 11011-16 | 16    | 8  | 1,6 |
| 11011-18 | 18    | 9  | 2,3 |
| 11011-20 | 20    | 10 | 3,1 |
| 11011-24 | 24    | 12 | 5,4 |



**Sauté pan**

Casseruola bassa  
Stielkasserolle, niedrig  
Plat à sauter  
Cazo recto bajo

| art.      | Ø cm. | h.   | lt.  |
|-----------|-------|------|------|
| 11008-16  | 16    | 6,5  | 1,3  |
| 11008-18  | 18    | 7,0  | 1,8  |
| 11008-20  | 20    | 7,5  | 2,5  |
| 11008-24  | 24    | 8,0  | 3,7  |
| 11008-28* | 28    | 9,5  | 5,8  |
| 11008-32* | 32    | 11,0 | 9,2  |
| 11008-36* | 36    | 13,0 | 13,0 |

\*With loop handle. – Con contromaniglia.



**Frypan**

Padella  
Bratpfanne  
Poêle à frire  
Sartén

| art.      | Ø cm. | h.  |
|-----------|-------|-----|
| 11014-20  | 20    | 5,0 |
| 11014-24  | 24    | 5,0 |
| 11014-28  | 28    | 5,5 |
| 11014-32  | 32    | 6,0 |
| 11014-36* | 36    | 6,0 |
| 11014-40* | 40    | 6,0 |
| 11114-45* | 45    | 6,5 |

\*With loop handle. – Con contromaniglia.



**Frypan, non stick**

Padella, antiaderente  
Bratpfanne, nichttaftend  
Poêle, anti-adhérente  
Sartén antiadherente

| art.     | Ø cm. | h.  |
|----------|-------|-----|
| 11117-20 | 20    | 5,0 |
| 11117-24 | 24    | 5,0 |
| 11117-28 | 28    | 5,5 |
| 11117-32 | 32    | 6,0 |
| 11117-36 | 36    | 6,0 |
| 11117-40 | 40    | 6,0 |



**French omelet pan**

Tegame  
Servierpfanne  
Poêle à paella  
Paellera

| art.     | Ø cm. | h.  |
|----------|-------|-----|
| 11115-20 | 20    | 5,0 |
| 11115-24 | 24    | 5,0 |
| 11115-28 | 28    | 5,5 |
| 11115-32 | 32    | 6,0 |
| 11115-36 | 36    | 6,0 |
| 11115-40 | 40    | 6,0 |
| 11115-45 | 45    | 6,5 |
| 11115-50 | 50    | 8,0 |



**Cover**

Coperchio  
Deckel  
Couvercle  
Tapa

| art.     | Ø cm. |
|----------|-------|
| 11061-12 | 12    |
| 11061-16 | 16    |
| 11061-18 | 18    |
| 11061-20 | 20    |
| 11061-22 | 22    |
| 11061-24 | 24    |
| 11061-28 | 28    |
| 11061-32 | 32    |
| 11061-36 | 36    |
| 11061-40 | 40    |
| 11061-45 | 45    |
| 11061-50 | 50    |
| 11161-60 | 60    |





# SERIES 2000

STAINLESS STEEL COOKWARE  
PENTOLAME INOX



The serie 2000 has the same characteristics of the serie 1000. It varies only for the shape of the handles of 2 handles items. Perfect for use on any type of stove, whether gas, electric, glass ceramic cooking surface or induction stove. All items have an induction suited sandwich bottom.

La serie 2000 ha le stesse caratteristiche della serie 1000. Differisce solo per una diversa manicatura sugli articoli a 2 maniglie. Ideali per ogni tipo di cottura, gas, elettrica, vetroceramica e induzione. Tutti gli articoli sono dotati di speciale fondo termodiffusore adatto anche per piastre ad induzione.



**Stock pot**

Pentola  
Hoher Suppentopf  
Marmite traiteur  
Olla recta

| art.     | Ø cm. | h.   | lt.   |
|----------|-------|------|-------|
| 12001-16 | 16    | 16,0 | 3,2   |
| 12001-18 | 18    | 16,0 | 4,0   |
| 12001-20 | 20    | 18,0 | 5,5   |
| 12001-22 | 22    | 22,0 | 8,3   |
| 12001-24 | 24    | 24,0 | 10,5  |
| 12001-28 | 28    | 28,0 | 17,0  |
| 12001-32 | 32    | 27,5 | 20,4  |
| 12001-36 | 36    | 36,0 | 36,5  |
| 12001-40 | 40    | 40,0 | 50,0  |
| 12001-45 | 45    | 40,0 | 63,5  |
| 12001-50 | 50    | 50,0 | 98,0  |
| 12001-60 | 60    | 55,0 | 150,0 |



**Saucepot**

Casseruola alta  
Fleischtopf  
Brasière  
Cacerola alta

| art.     | Ø cm. | h.   | lt.  |
|----------|-------|------|------|
| 12007-16 | 16    | 9,5  | 1,9  |
| 12007-18 | 18    | 10,8 | 2,7  |
| 12007-20 | 20    | 12,0 | 3,8  |
| 12007-22 | 22    | 13,0 | 5,0  |
| 12007-24 | 24    | 14,5 | 6,5  |
| 12007-28 | 28    | 16,0 | 9,8  |
| 12007-32 | 32    | 19,5 | 15,4 |
| 12007-36 | 36    | 21,5 | 20,5 |
| 12007-40 | 40    | 24,0 | 30,1 |
| 12007-45 | 45    | 27,0 | 42,9 |
| 12007-50 | 50    | 30,0 | 58,0 |
| 12007-60 | 60    | 35,0 | 99,0 |



**Casserole pot**

Casseruola bassa  
Bratentopf  
Sautoir  
Cacerola baja

| art.     | Ø cm. | h.   | lt.  |
|----------|-------|------|------|
| 12009-16 | 16    | 6,5  | 1,3  |
| 12009-18 | 18    | 7,0  | 1,8  |
| 12009-20 | 20    | 7,5  | 2,5  |
| 12009-24 | 24    | 8,0  | 3,7  |
| 12009-28 | 28    | 9,5  | 5,8  |
| 12009-32 | 32    | 11,0 | 9,2  |
| 12009-36 | 36    | 13,0 | 13,0 |
| 12009-40 | 40    | 14,5 | 18,0 |
| 12009-45 | 45    | 15,5 | 24,6 |
| 12009-50 | 50    | 19,0 | 37,0 |
| 12009-60 | 60    | 25,0 | 70,7 |



**Sauté pan**

Casseruola conica  
Sauteuse  
Sauteuse  
Cazo cónico

| art.     | Ø cm. | h.  | lt. |
|----------|-------|-----|-----|
| 11012-16 | 16    | 6,0 | 1,0 |
| 11012-18 | 18    | 6,0 | 1,2 |
| 11012-20 | 20    | 6,5 | 1,6 |
| 11012-24 | 24    | 7,5 | 2,7 |



**Curved sauté pan**

Casseruola bombé  
Sauteuse mit Schüttrand  
Sauteuse bombé  
Cazo bombeado

| art.     | Ø cm. | h.  | lt. |
|----------|-------|-----|-----|
| 11013-18 | 18    | 7,0 | 1,7 |
| 11013-20 | 20    | 7,5 | 2,2 |
| 11013-24 | 24    | 8,5 | 3,3 |
| 11013-26 | 26    | 9,0 | 4,2 |



**Saucepan**

Casseruola mezza alta  
Stielkasserolle, mittelhoch  
Casserole  
Cazo recto francés

| art.     | Ø cm. | h.   | lt. |
|----------|-------|------|-----|
| 11011-16 | 16    | 8,0  | 1,6 |
| 11011-18 | 18    | 9,0  | 2,3 |
| 11011-20 | 20    | 10,0 | 3,1 |
| 11011-24 | 24    | 12,0 | 5,4 |



**Asparagus-pot with lid**

Pentola cuociasparagi con coperchio  
Spargeltopf mit Deckel  
Cuit-asperges avec couvercle  
Olla espárragos con tapa

| art.     | Ø cm. | h.   | lt. |
|----------|-------|------|-----|
| 12037-16 | 16    | 24,0 | 4,8 |



**Steamer pot, perforated bottom**

Inserto a vapore, fondo forato  
Dampf-Siebeinsatz  
Casserole à vapeur, perforée  
Cacerola base perforada

| art.     | Ø cm. | h.   |
|----------|-------|------|
| 12119-20 | 20    | 12,5 |
| 12119-24 | 24    | 15,0 |
| 12119-28 | 28    | 17,0 |
| 12119-32 | 32    | 19,0 |



**Saucepan**

Casseruola alta  
Stielkasserolle, hoch  
Casserole haute  
Cazo recto alto

| art.      | Ø cm. | h.   | lt.  |
|-----------|-------|------|------|
| 11006-12  | 12    | 7,0  | 0,8  |
| 11006-14  | 14    | 8,0  | 1,2  |
| 11006-16  | 16    | 9,5  | 1,9  |
| 11006-18  | 18    | 10,8 | 2,7  |
| 11006-20  | 20    | 12,0 | 3,8  |
| 11006-22  | 22    | 13,0 | 5,0  |
| 11006-24  | 24    | 14,5 | 6,5  |
| 11006-28* | 28    | 16,0 | 9,8  |
| 11006-32* | 32    | 19,5 | 15,4 |
| 11006-36* | 36    | 21,5 | 20,5 |

\*With loop handle. – Con contromaniglia.



**Sauté pan**

Casseruola bassa  
Stielkasserolle, niedrig  
Plat à sauter  
Cazo recto bajo

| art.      | Ø cm. | h.   | lt.  |
|-----------|-------|------|------|
| 11008-16  | 16    | 6,5  | 1,3  |
| 11008-18  | 18    | 7,0  | 1,8  |
| 11008-20  | 20    | 7,5  | 2,5  |
| 11008-24  | 24    | 8,0  | 3,7  |
| 11008-28* | 28    | 9,5  | 5,8  |
| 11008-32* | 32    | 11,0 | 9,2  |
| 11008-36* | 36    | 13,0 | 13,0 |

\*With loop handle. – Con contromaniglia.



**Frypan**

Padella  
Bratpfanne  
Poêle à frire  
Sartén

| art.      | Ø cm. | h.  |
|-----------|-------|-----|
| 11014-20  | 20    | 5,0 |
| 11014-24  | 24    | 5,0 |
| 11014-28  | 28    | 5,5 |
| 11014-32  | 32    | 6,0 |
| 11014-36* | 36    | 6,0 |
| 11014-40* | 40    | 6,0 |
| 11114-45* | 45    | 6,5 |

\*With loop handle. – Con contromaniglia.



**Frypan, non stick**

Padella, antiaderente  
Bratpfanne, nichttaftend  
Poêle, anti-adhérente  
Sartén antiadherente

| art.     | Ø cm. | h.  |
|----------|-------|-----|
| 11117-20 | 20    | 5,0 |
| 11117-24 | 24    | 5,0 |
| 11117-28 | 28    | 5,5 |
| 11117-32 | 32    | 6,0 |
| 11117-36 | 36    | 6,0 |
| 11117-40 | 40    | 6,0 |



**French omelet pan**

Tegame  
Servierpfanne  
Poêle à paella  
Paellera

| art.     | Ø cm. | h.  |
|----------|-------|-----|
| 11115-20 | 20    | 5,0 |
| 11115-24 | 24    | 5,0 |
| 11115-28 | 28    | 5,5 |
| 11115-32 | 32    | 6,0 |
| 11115-36 | 36    | 6,0 |
| 11115-40 | 40    | 6,0 |
| 11115-45 | 45    | 6,5 |
| 11115-50 | 50    | 8,0 |



**Cover**

Coperchio  
Deckel  
Couvercle  
Tapa

| art.     | Ø cm. |
|----------|-------|
| 11061-16 | 16    |
| 11061-18 | 18    |
| 11061-20 | 20    |
| 11061-22 | 22    |
| 11061-24 | 24    |
| 11061-28 | 28    |
| 11061-32 | 32    |
| 11061-36 | 36    |
| 11061-40 | 40    |
| 11061-45 | 45    |
| 11061-50 | 50    |
| 11161-60 | 60    |



# FOR GLUTEN-FREE COOKING



AL SERVIZIO DELLA CUCINA SENZA GLUTINE

FOR PRODUCT # LIST SEE PAGES FROM 521 TO 525  
PER L'ELENCO PRODOTTI VEDI PAGINE DA 521 A 525



Consistently with the functional approach, which has always marked the brand, Paderno offers a complete product line and professional tools, easily recognizable in the kitchen, which can reduce possible mistakes during their use to protect people affected by celiac disease. Developed and realized in 2013 in collaboration with Associazione Italiana Celiachia Lombardia ONLUS (Italian Society for the Celiac Disease – Lombardy Section), this project makes Sambonet Paderno Industrie S.p.A. the first company in its market that offers to the HoReCa channel a complete line of items intended for gluten-free cooking.

Some distinguished special features, such as golden PVD handles for pans and pots and a special customised logo for utensils, will allow professionals to easily identify all these items in the kitchen.

This product line aims at:

- Reducing the risk of accidental food cross-contamination;
- Making it easier for professionals to work and provide services to clients with food intolerances;
- Raising awareness on the gluten-free diet issue in the industry so as to respond to the new needs of consumers.

Coerentemente all'ottica di servizio che contraddistingue da sempre il marchio, Paderno propone una linea completa di articoli e strumenti professionali facilmente identificabili in cucina, in grado di abbattere eventuali errori durante il loro utilizzo a salvaguardia del cliente celiaco e di tutti gli intolleranti. Sviluppato e concretizzato nel 2013 in collaborazione con l'Associazione Italiana Celiachia Lombardia ONLUS, questo progetto colloca Sambonet Paderno Industrie come prima azienda del settore a offrire al canale Ho.Re.Ca una linea completa di articoli da destinare alla preparazione di pietanze senza glutine.

Attraverso alcuni elementi distintivi e differenzianti, come manici in PVD oro per pentole e padelle e personalizzazione con un logo specifico per utensili, tutti gli strumenti saranno facilmente identificabili in cucina.

Questa gamma contribuisce a:

- Diminuire il rischio di accidentali contaminazioni crociate degli alimenti;
- Facilitare il professionista nell'operare e nell'offrire un servizio a favore del cliente con intolleranze alimentari;
- Sensibilizzare il settore sul tema "gluten free" di fronte alle nuove esigenze dei consumatori.



# SERIES 2500 3-PLY

STAINLESS STEEL COOKWARE  
PENTOLAME INOX



Paderno serie 2500 3-ply is especially designed for professional kitchens, features super heat-conductive multi-layer construction that distributes heat from bottom to rim quickly and evenly. Outside and inside satin polished. Non-drip edge. Stainless steel handles, ergonomically shaped. Uniform thickness in sides and bottoms. Energy saving on all types of cookers. Suitable for all cooking ranges, induction hobs included. induzione.

La serie Paderno 2500 3-ply concepita per l'utilizzo nelle cucine professionali è costruita in materiale multistrato che assicura una distribuzione rapida ed uniforme del calore su tutta la superficie dell'utensile. Finitura esterna ed interna satinata. Bordo a versare. Manicatura anatomica in acciaio inox. Parete e fondo a spessore uniforme. Risparmio di energia su tutti i piani di cottura. Ideali per ogni tipo di cottura inclusa l'induzione.



**Saucepot**

Casseruola alta  
Fleischtopf  
Brasière  
Cacerola alta

| art.     | Ø cm. | h.   | lt. |
|----------|-------|------|-----|
| 12507-24 | 24    | 11,5 | 5,0 |
| 12507-28 | 28    | 14,0 | 8,5 |



**Casserole pot**

Casseruola bassa  
Bratentopf  
Sautoir  
Cacerola baja

| art.     | Ø cm. | h.   | lt. |
|----------|-------|------|-----|
| 12509-20 | 20    | 9,5  | 2,8 |
| 12509-24 | 24    | 10,5 | 4,7 |
| 12509-28 | 28    | 11,0 | 6,5 |



**Saucepan**

Casseruola mezza alta  
Stielkasserolle, mittelhoch  
Casserole  
Cazo recto francés

| art.     | Ø cm. | h.   | lt. |
|----------|-------|------|-----|
| 12511-16 | 16    | 7,5  | 1,5 |
| 12511-18 | 18    | 8,0  | 2,0 |
| 12511-20 | 20    | 8,8  | 2,5 |
| 12511-24 | 24    | 10,5 | 4,6 |



**Sauté pan**

Casseruola bassa  
Stielkasserolle, niedrig  
Plat à sauter  
Cazo recto bajo

| art.     | Ø cm. | h.  | lt. |
|----------|-------|-----|-----|
| 12508-24 | 24    | 5,0 | 2,0 |



**Wok with grid and cover**

Wok c/griglia e coperchio  
Wok mit Rost und Deckel  
Wok avec grille et couvercle  
Wok con rejilla y tapa

| art.     | Ø cm. | h. |
|----------|-------|----|
| 12529-32 | 32    | 8  |



**Curved sauté pan**

Casseruola bombé  
Sauteuse mit Schüttrand  
Sauteuse bombé  
Cazo bombeado

| art.     | Ø cm. | h.  | lt. |
|----------|-------|-----|-----|
| 12513-16 | 16    | 6,0 | 1,2 |
| 12513-18 | 18    | 6,5 | 1,6 |
| 12513-20 | 20    | 7,0 | 2,0 |
| 12513-24 | 24    | 8,5 | 3,8 |



**Frypan**

Padella  
Bratpfanne  
Poêle à frire  
Sartén

| art.     | Ø cm. | h.  |
|----------|-------|-----|
| 12514-24 | 24    | 5,5 |
| 12514-26 | 26    | 5,5 |
| 12514-28 | 28    | 5,5 |
| 12514-32 | 32    | 4,0 |
| 12514-36 | 36    | 4,0 |



**Frypan, non stick coating**

Padella, antiaderente  
Bratpfanne mit Antihftbeschichtung  
Poêle avec revêtement anti-adhésif  
Sartén antiaderente

| art.     | Ø cm. | h.  |
|----------|-------|-----|
| 12517-24 | 24    | 5,5 |
| 12517-26 | 26    | 5,5 |
| 12517-28 | 28    | 5,5 |
| 12517-32 | 32    | 5,5 |
| 12517-36 | 36    | 5,5 |





**Frypan**

Padella  
Bratpfanne  
Poêle à frire  
Sartén

| art.     | Ø cm. | h.  |
|----------|-------|-----|
| 12514-20 | 20    | 3,0 |

**Mirror finishing.** – Finitura lucida.



**Saucepot with lid**

Casseruola alta, con coperchio  
Fleischtopf mit Deckel  
Brasière avec couvercle  
Cacerola alta con tapa

| art.     | Ø cm. | h. | lt. |
|----------|-------|----|-----|
| 12509-12 | 12    | 6  | 0,7 |

**Mirror finishing.** – Finitura lucida.



**Sauté pan with double spouts**

Casseruola bassa con doppio becco  
Stielkasserolle, niedrig, 2 Schnabel  
Plat à sauter, 2 becs  
Cazo recto bajo, 2 picos

| art.     | Ø cm. | h. | lt. |
|----------|-------|----|-----|
| 12511-10 | 10    | 5  | 0,4 |

**Mirror finishing.** – Finitura lucida.



**Sauté pan**

Casseruola bassa  
Stielkasserolle, niedrig  
Plat à sauter  
Cazo recto bajo

| art.     | Ø cm. | h. | lt. |
|----------|-------|----|-----|
| 12511-12 | 12    | 6  | 0,7 |
| 12511-14 | 14    | 7  | 1,0 |

**Mirror finishing.** – Finitura lucida.



**Cover**

Coperchio  
Deckel  
Couvercle  
Tapa

| art.     | Ø cm. |
|----------|-------|
| 12561-12 | 12    |
| 12561-16 | 16    |
| 12561-18 | 18    |
| 12561-20 | 20    |
| 12561-24 | 24    |
| 12561-26 | 26    |
| 12561-28 | 28    |



**Cover**

Coperchio  
Deckel  
Couvercle  
Tapa

| art.     | Ø cm. |
|----------|-------|
| 11061-12 | 12    |
| 11061-16 | 16    |
| 11061-18 | 18    |
| 11061-20 | 20    |
| 11061-24 | 24    |
| 11061-28 | 28    |





# MISCELLANEOUS COMPLEMENTI

STAINLESS STEEL COOKWARE  
PENTOLAME INOX

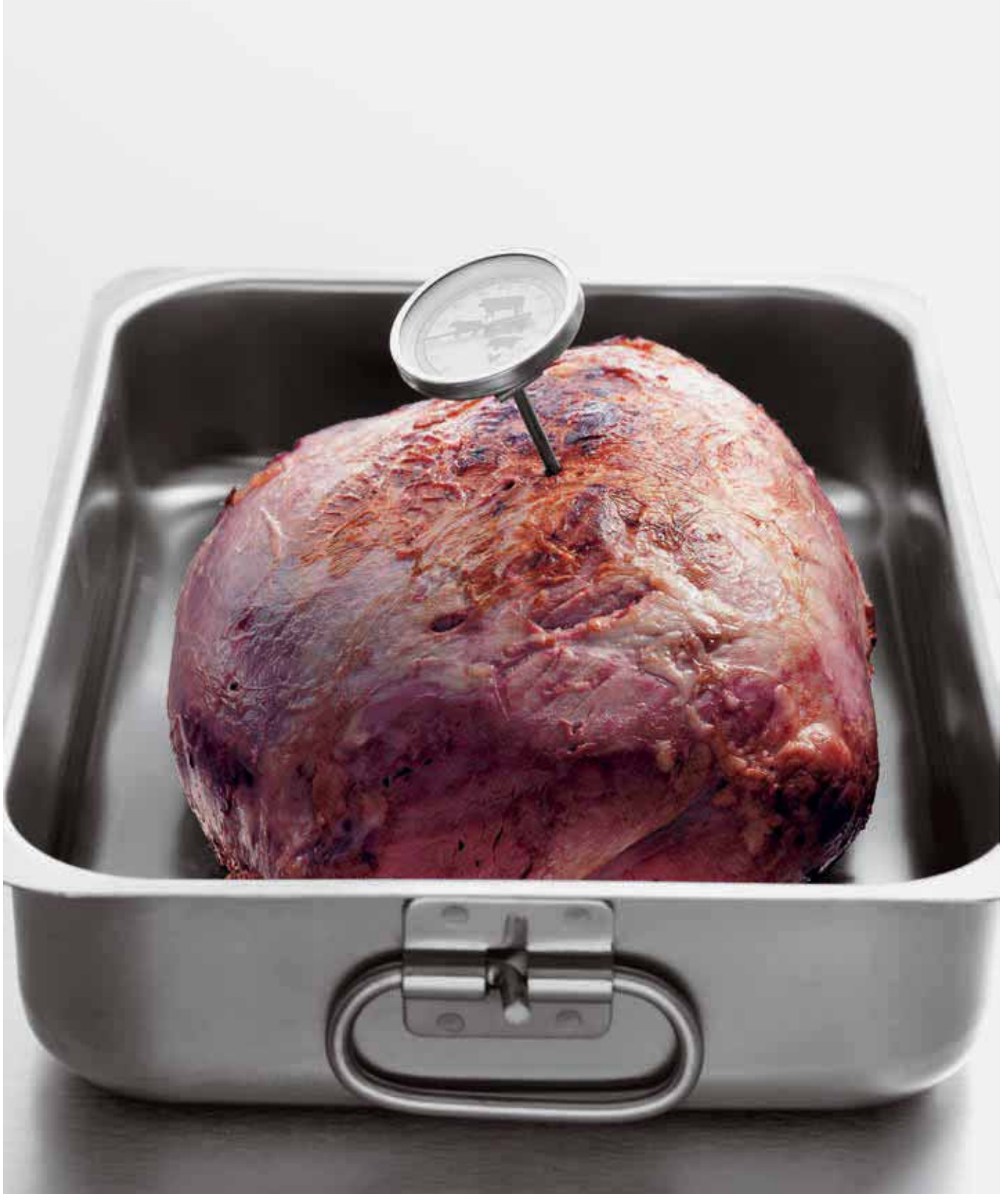



**Roasting pan**

Tegame  
Bräter  
Plaque à rôtir  
Rustidera

| art.     | cm.   | h. |
|----------|-------|----|
| 11941-35 | 35x25 | 8  |
| 11941-40 | 40x26 | 9  |
| 11941-45 | 45x30 | 9  |
| 11941-50 | 50x30 | 9  |
| 11941-60 | 60x35 | 9  |



**Heavy roasting pan**

Tegame pesante  
Bräter, Schwerausführung  
Plaque à rôtir lourde  
Rustidera pesada

| art.      | cm.   | h. |
|-----------|-------|----|
| 11943-40  | 40x26 | 9  |
| 11943-45  | 45x30 | 9  |
| 11943-50  | 50x30 | 9  |
| 11943-60  | 60x35 | 9  |
| 11943-61* | 61x43 | 9  |

\*For 2/1 GN ovens. – Per forno GN 2/1.



**Heavy roasting pan**

Tegame pesante  
Bräter, Schwerausführung  
Plaque à rôtir lourde  
Rustidera pesada

| art.      | cm.   | h. |
|-----------|-------|----|
| 11944-40  | 40x26 | 9  |
| 11944-45  | 45x30 | 9  |
| 11944-50  | 50x30 | 9  |
| 11944-60  | 60x35 | 9  |
| 11944-61* | 61x43 | 9  |

\*For 2/1 GN ovens. – Per forno GN 2/1.



**Lid**

Coperchio  
Deckel  
Couvercle  
Tapa

| art.      | cm.   |
|-----------|-------|
| 11948-40  | 40x26 |
| 11948-45  | 45x30 |
| 11948-50  | 50x30 |
| 11948-60  | 60x35 |
| 11948-61* | 61x43 |

\*For 2/1 GN ovens. – Per forno GN 2/1.



**Roasting pan with cover**

Brasiera con coperchio  
Brasiere mit Deckel  
Braisière avec couvercle  
Rustidera alta con tapa

| art.      | cm.   | h. |
|-----------|-------|----|
| 11965-50  | 50x30 | 15 |
| 11965-60  | 60x35 | 15 |
| 11965-61* | 61x43 | 15 |

\*For 2/1 GN ovens. – Per forno GN 2/1.



**Fish kettle**

Pesciera  
Fischkochkessel  
Poissonnière  
Hervidor pescado

| art.     | cm.    | h. | lt. |
|----------|--------|----|-----|
| 11963-99 | 100x25 | 20 | 44  |

**Equipped with grid and cover.**  
Fornita con griglia e coperchio.



INDUCTION  
READY!

**Fish kettle**

Pesciera  
Fischkochkessel  
Poissonnière  
Hervidor pescado

| art.     | cm.       | h.   |
|----------|-----------|------|
| 41964-45 | 46x15,5   | 10,5 |
| 41964-60 | 61,5x18,5 | 11,0 |

**Equipped with grid and cover.**  
Fornita con griglia e coperchio.



**Whistling kettle**

Bollitore  
Kocher  
Bouilloire à sifflet  
Pava

| art.     | lt. |
|----------|-----|
| 41914-03 | 2,8 |



**Fry dripping tray, stainless steel**

Colafritto, inox  
Pommes-Frites-Seiher, Edelstahl Rostfrei  
Egouttoir à friture, inox  
Escurridor para fritura, inox

| art.     | Ø cm. | h. |
|----------|-------|----|
| 41930-39 | 41    | 14 |

**Detachable drip tray.**  
Vassoio raccogli liquidi removibile.



**Canister**

Contentitore cilindrico  
Behälter  
Bahut  
Contenedor cilíndrico

| art.     | Ø cm. | h. | lt.  |
|----------|-------|----|------|
| 11913-16 | 16    | 12 | 2,4  |
| 11913-20 | 20    | 16 | 5,0  |
| 11913-24 | 24    | 20 | 9,0  |
| 11913-28 | 28    | 24 | 14,5 |



**Bain-marie pot**

Casseroola bagnomaria  
Wasserbadkasserolle  
Casserole bain-marie  
Baño maria

| art.     | Ø cm. | h. | lt. |
|----------|-------|----|-----|
| 11910-12 | 12    | 14 | 1,4 |
| 11910-14 | 14    | 16 | 2,5 |
| 11910-16 | 16    | 18 | 3,6 |
| 11910-18 | 18    | 20 | 5,0 |
| 11910-20 | 20    | 22 | 7,0 |



**Bain-marie pot**

Bagnomaria  
Behälter  
Casserole bain-marie  
Baño maria

| art.     | Ø cm. | h. | lt. |
|----------|-------|----|-----|
| 11911-12 | 12    | 14 | 1,4 |
| 11911-14 | 14    | 16 | 2,5 |
| 11911-16 | 16    | 18 | 3,6 |
| 11911-18 | 18    | 20 | 5,0 |
| 11911-20 | 20    | 22 | 7,0 |



**Bain-marie, stackable**

Bagno-maria impilabili  
Bain-Marie, stapelbar  
Bain-marie, empilables  
Baño maria, apilable

| art.     | cm.   | h.   | lt.  |
|----------|-------|------|------|
| 44501-01 | 24x24 | 23,5 | 13,0 |
| 44501-02 | 24x24 | 16,0 | 9,0  |
| 44501-03 | 24x24 | 7,5  | 4,0  |



**Bain-marie, stackable**

Bagno-maria impilabili  
Bain-Marie, stapelbar  
Bain-marie, empilables  
Baño maria, apilable

| art.     | cm.       | h.   | lt. |
|----------|-----------|------|-----|
| 44502-01 | 15,5x15,5 | 23,5 | 5,0 |
| 44502-02 | 15,5x15,5 | 16,0 | 3,5 |
| 44502-03 | 15,5x15,5 | 7,5  | 1,5 |



**Bain-marie, stackable**

Bagno-maria impilabili  
Bain-Marie, stapelbar  
Bain-marie, empilables  
Baño maria, apilable

| art.     | cm.       | h.   | lt. |
|----------|-----------|------|-----|
| 44503-01 | 15,5x10,5 | 16,0 | 2,5 |
| 44503-02 | 15,5x10,5 | 7,5  | 1,0 |
| 44503-03 | 15,5x10,5 | 5,5  | 0,5 |



**Bain-marie lid**

Coperchio bagnomaria  
Wasserbadkasserolle-Deckel  
Couverte pour bain-marie  
Tapa para baño maria

| art.     | cm.       |
|----------|-----------|
| 44501-04 | 24x24     |
| 44502-04 | 15,5x15,5 |
| 44503-04 | 15,5x10,5 |



**1/4-Segment colander**

Colapasta 1/4  
1/4 Seiher-Einsatz  
Passoire cuit-pâtes, 1/4  
Colador 1/4

| art.     | Ø cm. | h. | lt. |
|----------|-------|----|-----|
| 11922-36 | 36    | 23 | 5,5 |
| 11922-40 | 40    | 26 | 7,5 |

**For items/Per art.:**  
**11007-11107-12007-12107-16929.**



**1/4-Segment wire colander**

Colapasta 1/4 a rete  
1/4 Netzseiher-Einsatz  
Passoire cuit-pâtes à gaze, 1/4  
Colador red 1/4

| art.     | Ø cm. | h. |
|----------|-------|----|
| 12992-36 | 36    | 23 |
| 12992-40 | 40    | 26 |

**For items/Per art.:**  
**11007-11107-12007-12107-16929.**



# SERIES 6100

ALUMINUM COOKWARE  
PENTOLAME ALLUMINIO



Made in heavy duty aluminum.  
Hollow tubular handles in stainless steel 18/10, stay cool.  
Rounded corners provide easy cleanup.  
Thickness from mm 2 to mm 5,5.

Esecuzione in alluminio pesante.  
Manicatura tubolare in acciaio inossidabile 18/10, resistente al calore.  
Ampio raggio di raccordo fondo-parete, igienico e facile da pulire.  
Spessore da mm 2 a mm 5,5.



**Stock pot**

Pentola  
Hoher Suppentopf  
Marmite traiteur  
Olla recta

| art.     | Ø cm. | h.   | lt.   |
|----------|-------|------|-------|
| 16101-16 | 16    | 16,0 | 3,2   |
| 16101-20 | 20    | 20,0 | 6,2   |
| 16101-24 | 24    | 24,0 | 10,0  |
| 16101-28 | 28    | 28,0 | 16,5  |
| 16101-32 | 32    | 29,5 | 22,0  |
| 16101-36 | 36    | 36,0 | 36,0  |
| 16101-40 | 40    | 40,0 | 50,0  |
| 16101-45 | 45    | 45,0 | 70,0  |
| 16101-50 | 50    | 50,0 | 100,0 |



**Saucepot**

Casseruola alta  
Fleischtopf  
Brasière  
Cacerola alta

| art.     | Ø cm. | h.   | lt.  |
|----------|-------|------|------|
| 16107-16 | 16    | 11,0 | 2,1  |
| 16107-20 | 20    | 13,0 | 4,0  |
| 16107-24 | 24    | 15,0 | 6,5  |
| 16107-28 | 28    | 17,5 | 10,8 |
| 16107-32 | 32    | 19,5 | 15,7 |
| 16107-36 | 36    | 21,0 | 21,5 |
| 16107-40 | 40    | 24,0 | 30,0 |
| 16107-45 | 45    | 27,0 | 43,0 |
| 16107-50 | 50    | 30,0 | 59,0 |



**Casserole pot**

Casseruola bassa  
Bratentopf  
Sautoir  
Cacerola baja

| art.     | Ø cm. | h.   | lt.  |
|----------|-------|------|------|
| 16109-24 | 24    | 9,5  | 4,3  |
| 16109-28 | 28    | 11,0 | 6,7  |
| 16109-32 | 32    | 12,5 | 10,0 |
| 16109-36 | 36    | 14,0 | 14,0 |
| 16109-40 | 40    | 16,0 | 20,0 |
| 16109-45 | 45    | 18,0 | 28,5 |
| 16109-50 | 50    | 19,0 | 37,0 |
| 16109-60 | 60    | 21,5 | 60,0 |



**Colander for stock pot**

Colapasta per pentola  
Seiher für Suppentopf  
Passoire pour marmite  
Colador para olla recta

| art.     | Ø cm. | h. |
|----------|-------|----|
| 16926-32 | 32    | 31 |
| 16926-36 | 36    | 37 |
| 16926-40 | 40    | 40 |



**Couscous pan**

Couscoussiera  
Couscoustopf  
Couscoussier  
Cuscusera

| art.     | Ø cm. | h.    | lt. |
|----------|-------|-------|-----|
| 46970-18 | 36    | 22+17 | 18  |
| 46970-25 | 40    | 25+20 | 25  |



**Potato steamer pot with cover**

Casseruola a vapore con coperchio  
Kartoffeldämpfer mit Deckel  
Marmite à pommes-de-terre avec couvercle  
Cuscusera con tapa

| art.     | Ø cm. | h.    | lt. |
|----------|-------|-------|-----|
| 16923-32 | 32    | 21+15 | 12  |
| 16923-36 | 36    | 23+17 | 18  |
| 16923-40 | 40    | 25+20 | 25  |



**Oval saucepan with cover**

Casseruola ovale con coperchio  
Ovale Kasserolle mit Deckel  
Casserole ovale avec couvercle  
Cacerola oval con tapa

| art.     | Ø cm. | h.   | lt. |
|----------|-------|------|-----|
| 16938-36 | 36    | 14,5 | 10  |
| 16938-40 | 40    | 16,0 | 14  |
| 16938-45 | 45    | 17,0 | 19  |



**Saucepan**

Casseruola alta  
Stielkasserolle, hoch  
Casserole haute  
Cazo recto alto

| art.     | Ø cm. | h.   | lt.  |
|----------|-------|------|------|
| 16106-16 | 16    | 11,0 | 2,1  |
| 16106-20 | 20    | 13,0 | 4,0  |
| 16106-24 | 24    | 15,0 | 6,5  |
| 16106-28 | 28    | 17,5 | 10,8 |



**Casserole pot**

Casseruola bassa  
Stielkasserolle, niedrig  
Sautoir  
Cacerola baja

| art.     | Ø cm. | h.   | lt. |
|----------|-------|------|-----|
| 16108-20 | 20    | 8,0  | 2,5 |
| 16108-24 | 24    | 9,5  | 4,3 |
| 16108-28 | 28    | 11,0 | 6,7 |



**Frypan**  
Padella  
Bratpfanne  
Poêle à frire  
Sartén

| art.     | Ø cm. | h.  |
|----------|-------|-----|
| 16114-20 | 20    | 4,0 |
| 16114-24 | 24    | 5,0 |
| 16114-28 | 28    | 5,0 |
| 16114-32 | 32    | 5,3 |
| 16114-36 | 36    | 6,0 |
| 16114-40 | 40    | 7,0 |



**French omelet pan**  
Tegame  
Servierpfanne  
Poêle à paella  
Paellera

| art.     | Ø cm. | h.  |
|----------|-------|-----|
| 16115-24 | 24    | 5,5 |
| 16115-28 | 28    | 6,0 |
| 16115-32 | 32    | 6,5 |
| 16115-36 | 36    | 7,0 |
| 16115-40 | 40    | 7,5 |
| 16115-45 | 45    | 7,5 |



**Cover**  
Coperchio  
Deckel  
Couvercle  
Tapa

| art.     | Ø cm. |
|----------|-------|
| 16961-16 | 16    |
| 16961-20 | 20    |
| 16961-24 | 24    |
| 16961-28 | 28    |
| 16961-32 | 32    |
| 16961-36 | 36    |
| 16961-40 | 40    |
| 16961-45 | 45    |
| 16961-50 | 50    |
| 16961-60 | 60    |



**Casserole pot, non stick**  
Casseruola alta, antiaderente  
Fleischtopf, nichtaftend  
Brsière, anti-adhérente  
Cacerola alta, antiadherente

| art.     | Ø cm. | h.   | lt.  |
|----------|-------|------|------|
| 16127-16 | 16    | 11,0 | 2,1  |
| 16127-20 | 20    | 13,0 | 4,0  |
| 16127-24 | 24    | 15,0 | 6,5  |
| 16127-28 | 28    | 17,5 | 10,8 |
| 16127-32 | 32    | 19,5 | 15,7 |
| 16127-36 | 36    | 21,0 | 21,5 |
| 16127-40 | 40    | 24,0 | 30,0 |



**Casserole pot, non stick**  
Casseruola bassa, antiaderente  
Bratentopf, nichtaftend  
Sautoir, anti-adhérente  
Cacerola baja, antiadherente

| art.     | Ø cm. | h.   | lt.  |
|----------|-------|------|------|
| 16120-24 | 24    | 9,5  | 4,3  |
| 16120-28 | 28    | 11,0 | 6,7  |
| 16120-32 | 32    | 12,5 | 10,0 |
| 16120-36 | 36    | 14,0 | 14,0 |
| 16120-40 | 40    | 16,0 | 20,0 |



**French omelet pan, non stick**  
Tegame, antiaderente  
Servierpfanne, nichtaftend  
Poêle à paella, anti-adhérente  
Paellera antiadherente

| art.     | Ø cm. | h.  |
|----------|-------|-----|
| 16116-28 | 28    | 6,5 |
| 16116-32 | 32    | 6,5 |
| 16116-36 | 36    | 7,0 |
| 16116-40 | 40    | 7,5 |



**Frypan, non stick**  
Padella, antiaderente  
Bratpfanne, nichtaftend  
Poêle, anti-adhérente  
Sartén antiadherente

| art.     | Ø cm. | h.  |
|----------|-------|-----|
| 41720-18 | 18    | 3,8 |
| 41720-20 | 20    | 3,8 |
| 41720-24 | 24    | 4,5 |
| 41720-28 | 28    | 5,4 |
| 41720-30 | 30    | 5,4 |
| 41720-32 | 32    | 5,6 |



**Frypan, non stick**  
Padella, antiaderente  
Bratpfanne, nichtaftend  
Poêle, anti-adhérente  
Sartén antiadherente

| art.     | Ø cm. | h.  |
|----------|-------|-----|
| 16117-20 | 20    | 4,0 |
| 16117-24 | 24    | 5,0 |
| 16117-28 | 28    | 5,0 |
| 16117-32 | 32    | 5,3 |
| 16117-36 | 36    | 6,0 |
| 16117-40 | 40    | 7,0 |



**Forged frypan, non stick**  
Padella forgiata, antiaderente  
Pfanne, geschmiedet, nichtaftend  
Poêle forgée, anti-adhérente  
Sartén forjada, antiadherente

| art.     | Ø cm. | h.  |
|----------|-------|-----|
| 11617-20 | 20    | 3,4 |
| 11617-24 | 24    | 4,2 |
| 11617-28 | 28    | 4,5 |
| 11617-32 | 32    | 5,5 |





**Frypan, non stick, cast iron handle**

Padella bombata antiaderente, manico ferro  
Bratpfanne, nichtaftend, Gusseisen-Stiel  
Poêle bombé, anti-adhérente, queue fonte  
Sartén antiadherente, mango hierro

| art.     | Ø cm. | h.  |
|----------|-------|-----|
| 16113-20 | 20    | 5,5 |
| 16113-24 | 24    | 6,5 |
| 16113-28 | 28    | 7,0 |
| 16113-32 | 32    | 7,5 |
| 16113-36 | 36    | 8,0 |
| 16113-40 | 40    | 8,5 |



**Frypan, non stick, cast iron handle**

Padella antiaderente, manico ferro  
Bratpfanne, nichtaftend, Gusseisen-Stiel  
Poêle, anti-adhérente, queue fonte  
Sartén antiadherente, mango hierro

| art.     | Ø cm. | h.  |
|----------|-------|-----|
| 16717-20 | 20    | 4,0 |
| 16717-24 | 24    | 5,0 |
| 16717-28 | 28    | 5,0 |
| 16717-32 | 32    | 5,3 |
| 16717-36 | 36    | 6,0 |
| 16717-40 | 40    | 7,0 |



**Crêpes pan, non stick**

Padella crêpes, antiaderente  
Crêpepfanne, nichtaftend  
Poêle à crêpes, anti-adhérente  
Sartén crêpes antiadherente

| art.     | Ø cm. |
|----------|-------|
| 16118-24 | 24    |



**Non-stick blinis pan**

Padella per blini, antiaderente  
Blinis-Pfännchen, nichtaftend  
Poêle à blinis, anti-adhérente  
Sartén blinis, antiadherente

| art.     | Ø cm. | h. |
|----------|-------|----|
| 16719-12 | 12    | 2  |



**Crêpes pan, non-stick**

Padella crêpes antiaderente  
Crêpes-Pfanne, nichtaftend  
Tuile à crêpes anti-adhérente  
Sartén para crêpes, antiadherente

| art.     | Ø cm. |
|----------|-------|
| 16712-22 | 22    |
| 16712-26 | 26    |
| 16712-30 | 30    |



**Bake roasting pan**

Tegame  
Pfanne  
Plat à four  
Rustidera

| art.      | cm.   | h.  |
|-----------|-------|-----|
| 16941-40  | 40x26 | 7,5 |
| 16941-45  | 45x30 | 7,5 |
| 16941-50  | 50x30 | 8,0 |
| 16941-60  | 60x35 | 9,0 |
| 16941-61* | 61x43 | 9,0 |

\*For 2/1 GN ovens. – Per forno GN 2/1.



**Bake roasting pan**

Tegame  
Pfanne  
Plat à four  
Rustidera

| art.      | cm.   | h.  |
|-----------|-------|-----|
| 16943-40  | 40x26 | 7,5 |
| 16943-45  | 45x30 | 7,5 |
| 16943-50  | 50x30 | 8,0 |
| 16943-60  | 60x35 | 9,0 |
| 16943-61* | 61x43 | 9,0 |

\*For 2/1 GN ovens. – Per forno GN 2/1.



**Bake roasting, non stick**

Tegame, antiaderente  
Pfanne, nichtaftend  
Plat à four, anti-adhérente  
Rustidera antiadherente

| art.      | cm.   | h.  |
|-----------|-------|-----|
| 16947-40  | 40x26 | 7,5 |
| 16947-45  | 45x30 | 7,5 |
| 16947-50  | 50x30 | 8,0 |
| 16947-60  | 60x35 | 9,0 |
| 16947-61* | 61x43 | 9,0 |

\*For 2/1 GN ovens. – Per forno GN 2/1.



**Lid for roasting pans**

Coperchio per tegami  
Deckel für Bräter  
Couvercle pour plaques à rôtir  
Tapa para rustidera

| art.     | cm.   |
|----------|-------|
| 16948-40 | 40x26 |
| 16948-45 | 45x30 |
| 16948-50 | 50x30 |
| 16948-60 | 60x35 |
| 16948-61 | 61x43 |





**Bake roasting pan**

Tegame basso  
Pfanne, flach  
Plat à four bas  
Bandeja horno

| art.     | cm.   | h. |
|----------|-------|----|
| 16944-45 | 45x30 | 4  |
| 16944-50 | 50x30 | 4  |
| 16944-60 | 60x35 | 4  |



**Roasting pan with cover**

Brasiera con coperchio  
Brasiere mit Deckel  
Braisière avec couvercle  
Rustidera alta con tapa

| art.     | cm.   | h. | lt. |
|----------|-------|----|-----|
| 16965-40 | 40x26 | 15 | 14  |
| 16965-50 | 50x30 | 15 | 21  |
| 16965-60 | 60x35 | 15 | 30  |



**Fish kettle**

Pesciera  
Fisch-Kochkessel  
Poissonnière  
Hervidor pescado

| art.     | cm.   | h. | lt. |
|----------|-------|----|-----|
| 16939-50 | 50x15 | 12 | 9   |
| 16939-60 | 60x17 | 13 | 13  |
| 16939-70 | 70x19 | 14 | 18  |
| 16939-80 | 80x24 | 17 | 30  |

Equipped with grid and cover. – Fornita con griglia e coperchio.



**Sauce-pot, aluminum**

Casseruola, alluminio  
Gemüsetopf, Aluminium  
Braisière, alu  
Cacerola, aluminio

| art.     | Ø cm. | h. | lt.  |
|----------|-------|----|------|
| 16929-36 | 36    | 17 | 17,0 |
| 16929-40 | 40    | 18 | 22,5 |

Supplied without colanders. – Fornita senza spicchi.



**1/4-Segment wire colander**

Colapasta 1/4 a rete  
1/4 Netzseihier-Einsatz  
Passoire cuit-pâtes à gaze, 1/4  
Colador red 1/4

| art.     | Ø cm. | h. |
|----------|-------|----|
| 12992-36 | 36    | 23 |
| 12992-40 | 40    | 26 |



**Bain-marie pot**

Bagnomaria  
Wasserbadkasserolle  
Casserole bain-marie  
Baño maria

| art.     | Ø cm. | h. | lt. |
|----------|-------|----|-----|
| 16910-14 | 14    | 16 | 2,5 |
| 16910-16 | 16    | 18 | 3,7 |
| 16910-18 | 18    | 20 | 5,0 |
| 16910-20 | 20    | 22 | 7,0 |



# STEEL FRYING PANS PADELLE FERRO



Iron is ideal for cooking at high temperatures because its low capacity of heat transmission prevents temperature leaps. As it is non-stick, food does not stick to it. It withstands very high temperatures and improves its performance with use. Iron pans are perfect for fried food, omelettes or fine crêpes. Wash the black iron pan in water as little as possible and always keep it greased. Iron pans are ideal also for cooking on induction hobs.

Il ferro è ottimo per le cotture a fuoco molto vivo perché, non avendo un'alta capacità di trasmettere calore, evita improvvisi sbalzi di temperatura. Essendo un materiale antiaderente, evita l'attaccamento dei cibi. Sopporta temperature elevatissime e col tempo migliora il suo rendimento. I recipienti in ferro sono i più adatti per frittare, omelette o sottili crêpes. La padella in ferro nera va lavata con acqua il meno possibile e mantenuta sempre unta. Il ferro è il materiale ideale anche per cotture a induzione.



**Blacksteel fish pan**  
Padella ovale  
Fischeisenpfanne, oval  
Coupe ovale  
Sartén oval

| art.     | cm.   | h.  |
|----------|-------|-----|
| 41719-32 | 32x23 | 5,0 |
| 41719-36 | 36x26 | 5,0 |
| 41719-40 | 40x28 | 5,5 |



**Blacksteel crêpes pan**  
Padella crêpes  
Crêpes Eisenpfanne  
Coupe lyonnaise à crêpes  
Sartén crêpes

| art.     | Ø cm. | h. |
|----------|-------|----|
| 11718-20 | 20    | 2  |
| 11718-22 | 22    | 2  |
| 11718-24 | 24    | 2  |



**Blinis pan**  
Padella per blini  
Blinis-Eisenpfännchen  
Poêle à blinis  
Sartén blinis

| art.     | Ø cm. | h. |
|----------|-------|----|
| 11715-12 | 12    | 2  |



**Heavy blacksteel frypan**  
Padella lionese, pesante  
Schwere Eisenpfanne  
Coupe lyonnaise extra-forte  
Sartén honda pesada

| art.     | Ø cm. | h.  |
|----------|-------|-----|
| 11714-20 | 20    | 3,8 |
| 11714-22 | 22    | 4,0 |
| 11714-24 | 24    | 4,5 |
| 11714-26 | 26    | 4,5 |
| 11714-28 | 28    | 4,5 |
| 11714-32 | 32    | 5,0 |
| 11714-36 | 36    | 5,5 |
| 11714-40 | 40    | 5,5 |
| 11714-45 | 45    | 5,5 |
| 11714-50 | 50    | 6,0 |



**Blacksteel frypan**  
Padella lionese  
Eisenpfanne  
Coupe lyonnaise  
Sartén honda

| art.     | Ø cm. | h.  |
|----------|-------|-----|
| 11716-16 | 16    | 4,0 |
| 11716-20 | 20    | 4,5 |
| 11716-22 | 22    | 4,5 |
| 11716-24 | 24    | 5,0 |
| 11716-26 | 26    | 5,5 |
| 11716-28 | 28    | 5,5 |
| 11716-32 | 32    | 6,0 |
| 11716-36 | 36    | 6,5 |
| 11716-40 | 40    | 7,0 |
| 11716-45 | 45    | 8,0 |



**Blacksteel paella pan**  
Padella per paella  
Paella Eisenpfanne  
Coupe lyonnaise à paella  
Paellera

| art.     | Ø cm. | h.  |
|----------|-------|-----|
| 11717-34 | 34    | 5,0 |
| 11717-37 | 37    | 5,5 |
| 11717-42 | 42    | 6,0 |
| 11717-47 | 47    | 6,5 |
| 41717-60 | 60    | 6,5 |
| 41717-80 | 80    | 9,0 |



**Blacksteel fish pan**  
Padella ovale  
Fischeisenpfanne, oval  
Coupe ovale  
Sartén oval

| art.     | cm.   |
|----------|-------|
| 41703-38 | 38x26 |



**Wok pan**  
Wok  
Wok-Pfanne  
Poêle chinoise  
Wok

| art.     | Ø cm. | h. |
|----------|-------|----|
| 11713-32 | 32    | 10 |
| 11713-40 | 40    | 11 |



**Chestnut pan**  
Padella per castagne  
Kastanienpfanne  
Poêle à marrons  
Sartén para castañas

| art.     | Ø cm. |
|----------|-------|
| 11721-28 | 28    |



**Silicone sleeve**  
Coprimanico silicone  
Silikon-Stielhülle  
Revêtement manche en silicone  
Cubre mango silicona

| art.     | Ø cm. | col. |
|----------|-------|------|
| 11710-AA | 20-36 | ●    |
| 11710-AB | 40-50 | ●    |

Heat resistant up to 230°C. Resistenza al calore fino a 230°C. Suits items! Per art: 16717, 16113, 16712, 11714, 11716, 11718, 11713, 11721.



**Fry pan**  
Padella per friggere  
Frittier-Pfanne  
Tuile à frire  
Sartén freidora

| art.     | Ø cm. | h.   | lt.  |
|----------|-------|------|------|
| 41707-32 | 32    | 9,8  | 6,0  |
| 41707-36 | 36    | 11,0 | 8,8  |
| 41707-40 | 40    | 13,4 | 12,2 |
| 41707-45 | 45    | 15,0 | 17,3 |
| 41707-50 | 50    | 17,6 | 23,5 |



**Wire basket, tinned**  
Cestello per friggere, stagnato  
Frittier-Rost, verzinkt  
Grille à frire, étamée  
Cesta escurrefrito, estañada

| art.     | Ø cm. | h.   |
|----------|-------|------|
| 41708-32 | 32    | 11,0 |
| 41708-36 | 36    | 11,5 |
| 41708-40 | 40    | 12,4 |
| 41708-45 | 45    | 15,5 |
| 41708-50 | 50    | 16,5 |



# SERIES 15500 3-PLY

COPPER COOKWARE  
PENTOLAME RAME



Ideal for cooking and serving from the kitchen to the table. A working tool with a body made of three metals, copper, aluminum and steel. A mix for a homogenous and sweet thermal spread that ensures cooking without attacking the foods, preserving its nutritional properties and organoleptic characteristics. Inside stainless steel, practical and easy to clean. Middle layer aluminum, lightweight and a very good heat conductor. Exterior glossy copper finishing, a tradition in the kitchen, fascinating and beautiful to see. Solid brass handles assembled with strong section rivets. Suitable for use on all cooking hobs including induction.

Ideale per cucinare e servire nello stesso recipiente. Uno strumento di lavoro con un corpo formato da tre metalli, rame, alluminio e acciaio. Un mix per un'omogenea e dolce diffusione termica che assicura una cottura senza aggredire i cibi, preservandone le proprietà nutrizionali e le caratteristiche organolettiche. Lamina interna in acciaio inox, pratico e facile da pulire. Strato intermedio in alluminio, leggero e ottimo conduttore di calore. Esterno in rame finitura lucida, una tradizione in cucina, affascinante e bello da vedere. Manici e maniglie in ottone massiccio assemblati con rivetti di forte sezione. Adatto ad uso su tutti i fuochi inclusa l'induzione.



**Saucepan**

Casseruola alta  
Stielkasserolle, hoch  
Casserole haute  
Cazo recto alto

| art.     | Ø cm. | h. | lt. |
|----------|-------|----|-----|
| 15506-16 | 16    | 8  | 1,6 |
| 15506-20 | 20    | 11 | 3,5 |
| 15506-24 | 24    | 14 | 6,3 |
| 15506-28 | 28    | 16 | 9,8 |



**Casserole pot**

Casseruola bassa  
Stielkasserolle, niedrig  
Sautoir  
Cacerola baja

| art.     | Ø cm. | h. | lt. |
|----------|-------|----|-----|
| 15508-20 | 20    | 7  | 2,2 |
| 15508-24 | 24    | 8  | 3,6 |
| 15508-28 | 28    | 9  | 5,5 |



**Frypan**

Padella  
Bratpfanne  
Poêle à frire  
Sartén

| art.     | Ø cm. | h.  | lt. |
|----------|-------|-----|-----|
| 15514-20 | 20    | 4,5 | 1,4 |
| 15514-24 | 24    | 4,5 | 2,0 |
| 15514-28 | 28    | 5,5 | 3,4 |
| 15514-32 | 32    | 6,0 | 4,8 |



**Saucepot**

Casseruola alta  
Fleischtopf  
Brasière  
Cacerola alta

| art.     | Ø cm. | h. | lt. |
|----------|-------|----|-----|
| 15507-16 | 16    | 8  | 1,6 |
| 15507-20 | 20    | 11 | 3,5 |
| 15507-24 | 24    | 14 | 6,3 |
| 15507-28 | 28    | 16 | 9,8 |



**Casserole pot**

Casseruola bassa  
Bratentopf  
Sautoir  
Cacerola baja

| art.     | Ø cm. | h. | lt. |
|----------|-------|----|-----|
| 15509-20 | 20    | 7  | 2,2 |
| 15509-24 | 24    | 8  | 3,6 |
| 15509-28 | 28    | 9  | 5,5 |



**Frypan**

Padella  
Bratpfanne  
Poêle à paella  
Paellera

| art.     | Ø cm. | h.  | lt. |
|----------|-------|-----|-----|
| 15515-20 | 20    | 4,5 | 1,4 |
| 15515-24 | 24    | 4,5 | 2,0 |
| 15515-28 | 28    | 5,5 | 3,4 |
| 15515-32 | 32    | 6,0 | 4,8 |



**Cover**

Coperchio  
Deckel  
Couvercle  
Tapa

| art.     | Ø cm. |
|----------|-------|
| 15561-20 | 20    |
| 15561-24 | 24    |
| 15561-28 | 28    |





# MINI COOKWARE

## MINIATURE SERIES 15200 3-PLY

**COPPER COOKWARE**  
PENTOLAME RAME



Paderno Serie 15200 3-ply, inside stainless steel satin polished, intermediate layer in aluminum, outside copper mirror polished. Thickness 1,8 mm. Stainless steel handles with PVD gold finishing, stainless steel rivets. For use on any heating element (except on induction hob).

Serie Paderno 15200 3-ply, lamina interna in acciaio inox finitura satinata, strato intermedio in alluminio, esterno rame lucido. Spessore 1,8 mm. Manicatura in acciaio inox con finitura PVD oro, rivetti inox. Adatte ad uso su tutti i fuochi (eccetto induzione).



### Saucepan

Casseruola alta  
Stielkasserolle, hoch  
Casserole haute  
Cazo recto alto

| art.     | Ø cm. | h.  | lt.  |
|----------|-------|-----|------|
| 15226-07 | 7     | 4,0 | 0,15 |
| 15228-10 | 10    | 4,5 | 0,35 |



### Saucepan

Casseruola alta  
Stielkasserolle, hoch  
Casserole haute  
Cazo recto alto

| art.     | Ø cm. | h. | lt.  |
|----------|-------|----|------|
| 15226-10 | 10    | 7  | 0,50 |
| 15226-12 | 12    | 8  | 0,85 |
| 15226-14 | 14    | 9  | 1,30 |



### Frypan

Padella  
Bratpfanne  
Poêle à paella  
Paellera

| art.     | Ø cm. | h.  | lt.  |
|----------|-------|-----|------|
| 15224-10 | 10    | 3,0 | 0,20 |
| 15224-12 | 12    | 3,5 | 0,35 |
| 15224-14 | 14    | 4,5 | 0,70 |



### Saucepot

Casseruola alta  
Fleischtopf  
Brasière  
Cacerola alta

| art.     | Ø cm. | h. | lt.  |
|----------|-------|----|------|
| 15227-10 | 10    | 7  | 0,50 |
| 15227-12 | 12    | 8  | 0,85 |
| 15227-14 | 14    | 9  | 1,30 |



### Casserole pot

Casseruola bassa  
Bratentopf  
Sautoir  
Cacerola baja

| art.     | Ø cm. | h.  | lt.  |
|----------|-------|-----|------|
| 15229-10 | 10    | 4,5 | 0,35 |



### Omelet pan

Tegame  
Servierpfanne  
Poêle à paella  
Paellera

| art.     | Ø cm. | h.  | lt.  |
|----------|-------|-----|------|
| 15225-10 | 10    | 3,0 | 0,20 |
| 15225-12 | 12    | 3,5 | 0,35 |
| 15225-14 | 14    | 4,5 | 0,70 |



### Cover

Coperchio  
Deckel  
Couvercle  
Tapa

| art.     | Ø cm. |
|----------|-------|
| 15261-10 | 10    |
| 15261-12 | 12    |
| 15261-14 | 14    |





# SERIES 15300-15400

COPPER COOKWARE  
PENTOLAME RAME



Solid copper, thickness from 1,5 to 2,5 mm, the interiors are tinned over the fire by hand. Handles in highly polished solid brass, assembled with wide rivets. For use on any heating element (except on induction hob).

Rame massiccio, spessore da 1,5 a 2,5 mm internamente stagnato a mano sulla fiamma. Manici e maniglie in ottone massiccio lucidato a specchio ed assemblati con rivetti di forte sezione. Adatto ad uso su tutti i fuochi (eccetto induzione).



**Oval saucepan**  
Casseruola ovale  
Ovaler Bratentopf  
Casserole ovale  
Cacerola oval

| art.     | cm.   | h. |
|----------|-------|----|
| 15338-38 | 38x25 | 13 |



**Bake roasting pan**  
Tegame rettangolare  
Rechteckige Pfanne  
Plat à four  
Rustidera

| art.     | cm.   | h. |
|----------|-------|----|
| 15343-36 | 38x28 | 11 |



**Oval pan**  
Tegame ovale  
Ovale Bratpfanne  
Plat ovale à poignées  
Bandeja oval

| art.     | cm.   | h. |
|----------|-------|----|
| 15339-36 | 38x26 | 11 |



**Fish kettle**  
Pesciera  
Fischkochkessel  
Poissonnière  
Hervidor pescado

| art.     | cm.   | h. |
|----------|-------|----|
| 15438-50 | 50x18 | 11 |



**Bain-marie**  
Bagnomaria  
Wasserbadkasserolle  
Bain-marie  
Baño maría

| art.     | Ø cm. | h. |
|----------|-------|----|
| 15403-16 | 16    | 17 |

**With porcelain. – Con porcellana.**



**Fondue set**  
Set fonduta  
Fondue-Service  
Service à fondue  
Servicio para fondues

| art.     | Ø cm. | h. |
|----------|-------|----|
| 15430-11 | 16    | 26 |



**Sugar saucepan**  
Casseruola per zucchero  
Zuckerpfännchen  
Poelon à sucre  
Cacerola para azúcar

| art.     | Ø cm. | h. |
|----------|-------|----|
| 15406-16 | 16    | 9  |
| 15406-20 | 20    | 10 |



**Zabaione bowl**  
Casseruola per zabaione  
Zabaionekasserolle  
Poelon à zabaione  
Cacerola sabayón

| art.     | Ø cm. |
|----------|-------|
| 15407-16 | 16    |
| 15407-20 | 20    |



**Foot for zabaione bowl**  
Base per casseruola zabaione  
Fuss für Zabaionekasserolle  
Base pour poelon à zabaione  
Base para cacerola sabayón

| art.     | Ø cm. | h.  |
|----------|-------|-----|
| 15401-51 | 8     | 4,5 |



**Mixing bowl**  
Bastardella semisferica  
Schneeslagkessel  
Bassine hémisphérique  
Caldero

| art.     | Ø cm. |
|----------|-------|
| 15409-26 | 26    |
| 15409-30 | 30    |
| 15409-36 | 36    |

**Frosted finishing. – Finitura smerigliata.**



**Bordelais moulds**  
Stampo scanalato  
Bordelais-Kuchenform  
Moule à cannelés Bordelais  
Molde para bordelais

| art.     | Ø cm. | h. mm. |
|----------|-------|--------|
| 15415-03 | 5,5   | 5      |

**3 pcs set. – Set 3 pezzi.**





# MINI COOKWARE MINIATURE

COOKWARE  
PENTOLAME



Aluminum body non-stick coated, brass handles. A range of small pots ideal for side dishes and individual servings, soufflés, baked pasta, rice creams, raclette, savory as well as sweet pastries, desserts, etc.. Versatile, functional, ready to be served from the kitchen to the table. Original and yet traditional, they come from the world of haute cuisine, ideal for enhancing creations or the most simple recipes, for the sake of conviviality, to give a more playful aspect to our meals.

Corpo in alluminio con rivestimento antiaderente, manichatura in ottone. Una gamma di miniature ideali per contorni e singole porzioni, soufflé, pasta al forno, creme di riso, raclette, brioches salate e dolci, dessert, ecc., ecc.. Polivalenti, funzionali, pronte per essere servite dalla cucina alla tavola. Originali eppure tradizionali, provengono dal mondo dell'alta gastronomia, strumento ideale per valorizzare creazioni estrose o le più semplici ricette, per amore della convivialità, per donare un aspetto più ludico ai nostri pasti.



## Saucepan

Casseruola alta  
Stielkasserole, hoch  
Casserole haute  
Cazo recto alto

| art.     | Ø cm. | h. | lt.  |
|----------|-------|----|------|
| 16136-10 | 10    | 6  | 0,45 |



## Sauté pan

Casseruola bassa  
Stielkasserole, niedrig  
Plat à sauter  
Cazo recto bajo

| art.     | Ø cm. | h. | lt. |
|----------|-------|----|-----|
| 16138-10 | 10    | 4  | 0,3 |



## Frypan

Padella  
Bratpfanne  
Poêle à frire  
Sartén

| art.     | Ø cm. | h. | lt. |
|----------|-------|----|-----|
| 16134-12 | 12    | 4  | 0,4 |



## Saucepan

Casseruola alta  
Fleischtopf  
Casserole haute  
Cazo recto alto

| art.     | Ø cm. | h. | lt.  |
|----------|-------|----|------|
| 16137-10 | 10    | 6  | 0,45 |



## Casserole pot

Casseruola bassa  
Bratentopf  
Sautoir  
Cacerola baja

| art.     | Ø cm. | h. | lt. |
|----------|-------|----|-----|
| 16139-10 | 10    | 4  | 0,3 |



## French omelet pan

Tegamino  
Servierpfanne  
Poêle à paella  
Paellera

| art.     | Ø cm. | h. | lt. |
|----------|-------|----|-----|
| 16135-12 | 12    | 4  | 0,4 |



**Blinis pan, non-stick aluminum**

Padella blini, alluminio antiaderente  
Blinis-Pfännchen, Alu-Nichttaftend  
Poêle à blinis, alu anti-adhérente  
Sartén blinis, aluminio antiadherente

| art.     | Ø cm. | h. |
|----------|-------|----|
| 16719-12 | 12    | 2  |



**Blinis pan, steel**

Padella blini, ferro  
Blinis-Pfännchen, Eisen  
Poêle à blinis, acier  
Sartén blinis, hierro

| art.     | Ø cm. | h. |
|----------|-------|----|
| 11715-12 | 12    | 2  |



**Sauté pan with double spouts**

Casseruola con due becchi, 3-ply  
Stielkasserolle, niedrig, 2 Schnabel  
Plat à sauter, 2 becs  
Cazo recto bajo, 2 picos

| art.     | Ø cm. | h. | lt. |
|----------|-------|----|-----|
| 12511-10 | 10    | 5  | 0,4 |

**Mirror finishing. – Finitura lucida.**



**Sauté pan**

Casseruola bassa, 3-ply  
Stielkasserolle, niedrig  
Plat à sauter  
Cazo recto bajo

| art.     | Ø cm. | h. | lt. |
|----------|-------|----|-----|
| 12511-12 | 12    | 6  | 0,7 |

**Mirror finishing. – Finitura lucida.**



**Sauté pan**

Casseruola bassa, 3-ply  
Stielkasserolle, niedrig  
Plat à sauter  
Cazo recto bajo

| art.     | Ø cm. | h. | lt. |
|----------|-------|----|-----|
| 12511-14 | 14    | 7  | 1   |

**Mirror finishing. – Finitura lucida.**



**Saucepot with lid**

Casseruola con coperchio, 3-ply  
Fleischtopf mit Deckel  
Brasière avec couvercle  
Cacerola alta con tapa

| art.     | Ø cm. | h. | lt. |
|----------|-------|----|-----|
| 12509-12 | 12    | 6  | 0,7 |

**Mirror finishing. – Finitura lucida.**



**Saucepan, oval, Stoneware**

Casseruola ovale  
Kasserolle, oval  
Casserole, ovale  
Cacerola, oval

| art.     | cm.    | h.  |
|----------|--------|-----|
| 41210-03 | 13x8,2 | 3,9 |



**Saucepan, Stoneware**

Tegamimo  
Pfännchen  
Sautoir  
Fuente huevo

| art.     | Ø cm. | h. |
|----------|-------|----|
| 41210-12 | 13    | 5  |
| 41210-13 | 15    | 5  |
| 41210-14 | 17    | 5  |



**Saucepan, rectangular, Stoneware**

Casseruola rettangolare  
Kasserolle, rechteckig  
Casserole, rectangulaire  
Cacerola, rectangular

| art.     | cm.    | h.  |
|----------|--------|-----|
| 41210-05 | 13x8,2 | 3,9 |



**Piepan, Stoneware**

Tortiera  
Kuchenform  
Ramequin  
Molde tarta

| art.     | Ø cm. | h.  |
|----------|-------|-----|
| 41210-10 | 11    | 3,9 |



**Saucepan, round, Stoneware**

Casseruola tonda  
Kasserolle, rund  
Casserole, ronde  
Cacerola, redonda

| art.     | Ø cm. | h.  |
|----------|-------|-----|
| 41210-01 | 13    | 3,9 |



**Saucepan with lid, Stoneware**

Casseruola con coperchio  
Kasserolle mit Deckel  
Casserole avec couvercle  
Cacerola con tapa

| art.     | Ø cm. | h.  |
|----------|-------|-----|
| 41210-07 | 11,5  | 5,5 |
| 41210-08 | 13,0  | 7,5 |



# ENAMELLED CAST IRON GHISA SMALTATA

COOKWARE  
PENTOLAME



Suitable for use on all cooking hobs (gas, electric, ceramic, induction) and ovens (gas, oil, coal or wood) except microwave. A perfect harmony of cast iron, enamel and high quality. Designed and constructed to absorb and spread the heat evenly. Cast iron is suitable for all cooking techniques, for soups, roasts, rice, desserts, for braise that require a long cooking and likewise ideal for meats and grilled vegetables as it enhances flavors and aromas like barbecue style. Cast iron also features non-stick. The high temperature of the pan sears the meat surface. All the flavor, water and nutritional values remain sealed in the food. When cooking in casseroles, the steam generated thanks to the special design of the cover condenses falling back into the food not only retaining flavors and aromas but providing the best protection for nutrients and contributing to a healthy diet. Cast iron is a material 100% recyclable and therefore environmentally friendly. Moreover, thanks to its ability to retain heat for a long time it allows a considerable saving of energy. With closed lid on the table, the pot will preserve the temperature for a second serving. Cast iron retains the heat but as well the cold... can be used to keep the food fresh. Stored for a short time in the refrigerator, keeps food cool during hot summer days, ideal for serving pasta or rice salads, etc. Practical and easy to clean. These cast iron pots and pans are dishwasher safe thanks to the special technology applied to their enameling method. Ergonomic knobs and handles made of cast iron and stainless steel, suitable for use on all heat sources and ovens except microwave. Be careful, they heat up during cooking, it is recommended to handle with a dry thick cloth.

Idonee all'uso su tutte le fonti di cottura (gas, elettriche, vetroceramica, induzione) e forni (gas, petrolio, carbone o legna) ad esclusione di microonde. Una perfetta armonia tra ghisa, smalto e alta qualità. Progettate e costruite per assorbire e diffondere il calore in modo uniforme. La ghisa è adatta a tutte le tecniche di cottura, per zuppe, arrostiti, risotti, dolci, per piatti che richiedono una lunga cottura tipo brasati e allo stesso modo ideale per carni e verdure alla griglia in quanto ne esalta sapori ed aromi in stile barbecue. La ghisa ha anche caratteristiche di antiaderenza. La temperatura elevata della padella cauterizza la superficie della carne. Tutto il sapore, l'acqua e i valori nutrizionali rimangono sigillati nel cibo. Nella cottura in casseruole, il vapore generato grazie al particolare design del coperchio si condensa ricadendo e mescolandosi nuovamente nel cibo non solo trattenendo sapori e aromi ma fornendo la miglior protezione alle sostanze nutrienti e contribuendo ad una dieta sana. La ghisa è un materiale riciclabile al 100% e quindi ecologico. Inoltre, grazie alla sua capacità di mantenere il calore per lungo tempo consente un notevole risparmio di energia permettendo di cuocere a fuoco basso. Anche a tavola mantengono in cibi in temperatura. La ghisa mantiene però il caldo come pure il freddo... può essere usata per mantenere il cibo fresco. Riposta per un breve periodo in frigorifero, mantiene il cibo fresco nelle calde giornate estive e ideale per servire insalate di pasta, riso, farro, ecc., ecc. Pratica e facile da pulire. Queste casseruole e padelle in ghisa sono lavabili in lavastoviglie, per merito della speciale tecnologia applicata al metodo di smaltatura. Manicatura e pomoli dal design ergonomico sono in ghisa e inox. Durante la cottura si raccomanda di maneggiare con un panno consistente e asciutto per evitare di scottarsi.



**Saucepot round with lid**  
Casseruola tonda con coperchio  
Fleischtopf, rund mit Deckel  
Brasière avec couvercle  
Cacerola redonda con tapa

| art.     | Ø cm. | lt.  | col. |
|----------|-------|------|------|
| 44201R10 | 10    | 0,35 | ●    |
| 44201V10 | 10    | 0,35 | ●    |
| 44201B10 | 10    | 0,35 | ●    |
| 44201O10 | 10    | 0,35 | ●    |
| 44201N10 | 10    | 0,35 | ●    |

Portion: – Porzioni: 1



**Saucepot round with lid**  
Casseruola tonda con coperchio  
Fleischtopf, rund mit Deckel  
Brasière avec couvercle  
Cacerola redonda con tapa

| art.     | Ø cm. | lt.  | col. |
|----------|-------|------|------|
| 44201R12 | 12    | 0,55 | ●    |
| 44201V12 | 12    | 0,55 | ●    |
| 44201B12 | 12    | 0,55 | ●    |
| 44201O12 | 12    | 0,55 | ●    |
| 44201N12 | 12    | 0,55 | ●    |

Portion: – Porzioni: 1



**Oval saucepan with lid**  
Casseruola ovale con coperchio  
Ovaler Bratentopf mit Deckel  
Casserole ovale avec couvercle  
Cacerola oval con tapa

| art.     | cm.    | col. |
|----------|--------|------|
| 44202R12 | 12x9x6 | ●    |
| 44202V12 | 12x9x6 | ●    |
| 44202B12 | 12x9x6 | ●    |
| 44202O12 | 12x9x6 | ●    |
| 44202N12 | 12x9x6 | ●    |

Portion: – Porzioni: 1



**Saucepot stand**  
Supporto casseruolina  
Fleischtopf-Träger  
Support pour brasière  
Soporte para cacerola

| art.     | Ø cm. |
|----------|-------|
| 44201-01 | 10    |

W



**Saucepot stand**  
Supporto casseruolina  
Fleischtopf-Träger  
Support pour brasière  
Soporte para cacerola

| art.     | Ø cm. |
|----------|-------|
| 44201-03 | 10    |

W



**Saucepot platter**  
Sottopentola  
Fleischtopfbrett  
Planche à casserole  
Tabla para cacerola

| art.     | Ø cm. |
|----------|-------|
| 44201-10 | 10-12 |

W



**Saucepot platter**  
Sottopentola  
Fleischtopfbrett  
Planche à casserole  
Tabla para cacerola

| art.     | cm.  |
|----------|------|
| 44202-10 | 12x9 |

W



**Soufflé pot with wooden platter**  
Coppa soufflé con piatto legno  
Ramekin mit Holzbrett  
Ramequin avec planche bois  
Fuente soufflé con tabla madera

| art.     | Ø cm. | lt.  |
|----------|-------|------|
| 44240S08 | 8     | 0,17 |

Portion: – Porzioni: 1



**Saucepot with lid**  
Casseruola alta con coperchio  
Fleischtopf mit Deckel  
Brasière avec couvercle  
Cacerola alta con tapa

| art.     | Ø cm. | lt.  | Por.  |
|----------|-------|------|-------|
| 44201R16 | 16    | 1,0  | 1-2   |
| 44201R20 | 20    | 2,6  | 2-3   |
| 44201R24 | 24    | 4,5  | 4-5   |
| 44201R28 | 28    | 6,7  | 6-8   |
| 44201R32 | 32    | 10,0 | 12-16 |



**Saucepot with lid**  
Casseruola alta con coperchio  
Fleischtopf mit Deckel  
Brasière avec couvercle  
Cacerola alta con tapa

| art.     | Ø cm. | lt.  | Por.  |
|----------|-------|------|-------|
| 44201N16 | 16    | 1,0  | 1-2   |
| 44201N20 | 20    | 2,6  | 2-3   |
| 44201N24 | 24    | 4,5  | 4-5   |
| 44201N28 | 28    | 6,7  | 6-8   |
| 44201N32 | 32    | 10,0 | 12-16 |



**Saucepot with glass lid**  
Casseruola alta coperchio vetro  
Fleischtopf mit Glasdeckel  
Brasière avec couvercle verre  
Cacerola alta con tapa vidrio

| art.     | Ø cm. | lt. | Por. |
|----------|-------|-----|------|
| 44203R20 | 20    | 2,6 | 2-3  |
| 44203R24 | 24    | 4,5 | 4-5  |
| 44203R28 | 28    | 6,7 | 6-8  |



**Oval saucepan with lid**  
Casseruola ovale con coperchio  
Ovaler Bratentopf mit Deckel  
Casserole ovale avec couvercle  
Cacerola oval con tapa

| art.     | Ø cm. | lt. | Por. |
|----------|-------|-----|------|
| 44202R25 | 25    | 3,3 | 4    |
| 44202R27 | 27    | 4,0 | 4-6  |
| 44202R29 | 29    | 4,8 | 6    |



**Oval saucepan with lid**

Casseruola ovale con coperchio  
Ovaler Bratentopf mit Deckel  
Casserole ovale avec couvercle  
Cacerola oval con tapa

| art.     | Ø cm. | lt. | Por. |
|----------|-------|-----|------|
| 44202N25 | 25    | 3,3 | 4    |
| 44202N27 | 27    | 4,0 | 4-6  |
| 44202N29 | 29    | 4,8 | 6    |



**Casserole pot with glass lid**

Casseruola bassa con coperchio vetro  
Bratentopf mit Glasdeckel  
Sautoir avec couvercle verre  
Cacerola baja con tapa vidrio

| art.     | Ø cm. | lt. | Por. |
|----------|-------|-----|------|
| 44204R24 | 24    | 2,4 | 4    |
| 44204R28 | 28    | 3,4 | 4-6  |



**Saucepan with glass lid**

Casseruola alta con coperchio vetro  
Stielkasserolle, hoch mit Glasdeckel  
Casserole haute avec couvercle verre  
Cazo recto alto con tapa vidrio

| art.     | Ø cm. | lt. | Por. |
|----------|-------|-----|------|
| 44239R16 | 16    | 1,0 | 1-2  |



**Frypan**

Padella  
Bratpfanne  
Poêle

**Sartén**

| art.     | Ø cm. | lt.  | Por. |
|----------|-------|------|------|
| 44205-16 | 16    | 0,42 | 1    |
| 44205-20 | 20    | 0,80 | 1-2  |



**Frypan wooden handle**

Padella manico legno  
Bratpfanne mit Holz-Griff  
Poêle manche bois

**Sartén mango madera**

| art.     | Ø cm. | lt. | Por. |
|----------|-------|-----|------|
| 44205-24 | 24    | 1,5 | 4    |
| 44205-28 | 28    | 2,5 | 4-6  |



**Wok pan**

Wok  
Wok-Pfanne  
Poêle chinoise

**Wok**

| art.     | Ø cm. | lt. | Por. |
|----------|-------|-----|------|
| 44247-38 | 38    | 5,3 | 4    |





**W**

**Platter with magnetic feature**

Sottopentola magnetico  
Untersetzer, magnetisch  
Sous-plat magnétique  
Posavasos magnético

| art.     | Ø cm. |
|----------|-------|
| 44207-16 | 16    |
| 44207-20 | 20    |
| 44207-24 | 24    |
| 44207-28 | 28    |



**Grill pan**

Padella grill  
Grill-Pfanne  
Poêle grill  
Sartén grill

| art.     | cm.   | lt. | Por. |
|----------|-------|-----|------|
| 44209R26 | 26x26 | 2,2 | 4    |
| 44209R32 | 26x32 | 2,6 | 6    |



**Grill pan**

Padella grill  
Grill-Pfanne  
Poêle grill  
Sartén grill

| art.     | cm.   | lt.  | Por. |
|----------|-------|------|------|
| 44210-26 | 26x26 | 2,20 | 4    |
| 44210-32 | 26x32 | 2,75 | 6    |



**Silicone sleeves**

Coprimaniglie silicone  
Silikon-Griffhüllen  
Revêtement en silicone pour poignées  
Cubre asas de silicona

| art.     | col. |
|----------|------|
| 44208G00 | ●    |
| 44208R00 | ●    |



**Grill pan with wooden service stand**

Padella grill con tagliere a servire legno  
Grill-Pfanne mit Service-Holzbrett  
Poêle grill avec support à servir bois  
Sartén grill con tabla madera

| art.     | cm.   | lt.  | Por. |
|----------|-------|------|------|
| 44210S26 | 26x26 | 2,20 | 4    |
| 44210S32 | 26x32 | 2,75 | 6    |



**Grill pan**

Padella grill  
Grill-Pfanne  
Poêle grill  
Sartén grill

| art.     | cm.   | lt. | Por. |
|----------|-------|-----|------|
| 44210-42 | 31x42 | 4,5 | 8    |



**Grill pan with wooden service stand**

Padella grill con tagliere a servire legno  
Grill-Pfanne mit Service-Holzbrett  
Poêle grill avec support à servir bois  
Sartén grill con tabla madera

| art.     | cm.   | lt. | Por. |
|----------|-------|-----|------|
| 44210S42 | 31x42 | 4,5 | 8    |



**Bake roasting dish**

Tegame rettangolare  
Pfanne, rechteckig  
Plat rectangulaire  
Rustidera

| art.     | cm.   | Por. |
|----------|-------|------|
| 44218R30 | 22x30 | 6-8  |
| 44218R40 | 26x40 | 8-12 |



**Terrine pot**

Terrina  
Pasteten-Pfanne  
Terrine rectangle  
Fuente rectangular

| art.     | cm.        | Por. |
|----------|------------|------|
| 44219R26 | 8,5x26,5x6 | 2-4  |



**Grill pan and wooden service stand**

Padella grill con tagliere a servire legno  
Grill-Pfanne mit Service-Holzbrett  
Poêle grill avec plaque à servir bois  
Sartén grill con tabla madera

| art.     | cm.   | Por. |
|----------|-------|------|
| 44216S16 | 16x16 | 1    |

**Cups not included. – Ciotoline non include.**





**Grill pan with wooden platter**  
Padella grill con tagliere legno  
Grill-Pfanne mit Holzbrett  
Poêle grill avec plaque bois  
Sartén grill con tabla madera

| art.     | cm.   | Por. |
|----------|-------|------|
| 44215S16 | 16x16 | 1    |



**Griddle plate, dual side, reversible**  
Griglia reversibile  
Grill-Platte, zweiseitig, reversible  
Gril rectangle, reversible  
Parrilla reversible

| art.     | cm.   | Por. |
|----------|-------|------|
| 44217-45 | 26x47 | 6-8  |



**Grill pan**  
Bistecchiera  
Grill-Pfanne  
Poêle grill  
Sartén grill

| art.     | Ø cm. | lt.  | Por. |
|----------|-------|------|------|
| 44212-30 | 30    | 2,35 | 4-6  |



**Grill pan**  
Bistecchiera  
Grill-Pfanne  
Poêle grill  
Sartén grill

| art.     | cm.   | Por. |
|----------|-------|------|
| 44213-24 | 24x24 | 1-2  |
| 44213-36 | 21x36 | 2-4  |



**Grill pan**  
Bistecchiera  
Grill-Pfanne  
Poêle grill  
Sartén grill

| art.     | Ø cm. | Por. |
|----------|-------|------|
| 44214-25 | 25    | 2-3  |



**Fish plate with wooden platter**  
Piatto pesce con tagliere legno  
Fischplatte mit Holzbrett  
Plat à poisson avec planche bois  
Fuente pescado con tabla madera

| art.     | cm.   | Por. |
|----------|-------|------|
| 44220S24 | 15x24 | 1-2  |



**Fish plate with wooden platter**  
Piatto pesce con tagliere legno  
Fischplatte mit Holzbrett  
Plat à poisson avec planche bois  
Fuente pescado con tabla madera

| art.     | cm.       | Por. |
|----------|-----------|------|
| 44221S30 | 15,5x29,5 | 1-2  |



**Pizza pan**  
Piatto pizza  
Pizza-Platte  
Plat à pizza  
Fuente para pizza

| art.     | Ø cm. | Por. |
|----------|-------|------|
| 44222-20 | 20    | 1    |
| 44222-28 | 28    | 1    |



**Pizza pan with wooden platter**  
Piatto pizza con tagliere legno  
Pizza-Platte mit Holzbrett  
Plat à pizza avec planche bois  
Fuente para pizza con tabla madera

| art.     | Ø cm. | Por. |
|----------|-------|------|
| 44222S20 | 20    | 1    |
| 44222S28 | 28    | 1    |



**Griddle plate, dual side, reversible**  
Griglia reversibile  
Grill-Platte, zweiseitig, reversible  
Grill rectangle, reversible  
Parrilla reversible

| art.     | cm.   | Por. |
|----------|-------|------|
| 44224-22 | 22x15 | 1-2  |



**Grill plate and wooden platter**

Griglia reversibile con tagliere legno  
Grill-Platte mit Service-Holzbrett  
Grill avec plaque à servir bois  
Parrilla con tabla madera

| art.     | cm.   | Por. |
|----------|-------|------|
| 44224S22 | 22x15 | 1-2  |



**Table barbecue**

Barbecue da tavola  
Tischgrillplatte  
Barbecue de table  
Parrilla de mesa

| art.     | cm.   | Por. |
|----------|-------|------|
| 44225-22 | 22x15 | 1-2  |



**Griddle with wooden platter**

Griglia con tagliere legno  
Grill-Platte mit Holzbrett  
Grill rectangle avec planche bois  
Parrilla con tabla madera

| art.     | cm.   | Por. |
|----------|-------|------|
| 44226S30 | 22x30 | 2-3  |



**Table barbecue**

Barbecue da tavola  
Tischgrillplatte  
Barbecue de table  
Parrilla de mesa

| art.     | cm.   | Por. |
|----------|-------|------|
| 44227-30 | 22x30 | 2-3  |



**Fajita plate with wooden platter**

Piatto fajita con tagliere legno  
Fajitaplatte mit Holzbrett  
Plat à fajitas avec planche bois  
Fuente fajitas con tabla madera

| art.     | cm.   | Por. |
|----------|-------|------|
| 44228S23 | 17x23 | 1    |



**Fajita plate with wooden platter**

Piatto fajita con tagliere legno  
Fajitaplatte mit Holzbrett  
Plat à fajitas avec planche bois  
Fuente fajitas con tabla madera

| art.     | cm.   | Por. |
|----------|-------|------|
| 44229S20 | 10x20 | 1    |



**Oval plate with wooden platter**

Piatto ovale con tagliere legno  
Ovalplatte mit Holzbrett  
Plat oval avec planche bois  
Fuente ovale con tabla madera

| art.     | cm.       | Por. |
|----------|-----------|------|
| 44230S10 | 15x10x2,5 | 1    |
| 44230S14 | 21x14x2,5 | 1-2  |



**Oval plate with wooden platter**

Piatto ovale con tagliere legno  
Ovalplatte mit Holzbrett  
Plat oval avec planche bois  
Fuente ovale con tabla madera

| art.     | cm.       | Por. |
|----------|-----------|------|
| 44231-14 | 21x14x2,5 | 1-2  |

**Cups not included. – Ciotoline non incluse.**



**Round plate with wooden platter**

Piatto tondo con tagliere legno  
Platte mit Holzbrett, rund  
Plat rond avec planche bois  
Fuente redonda con tabla madera

| art.     | Ø cm. | Por. |
|----------|-------|------|
| 44232S12 | 12    | 1    |
| 44232S16 | 16    | 1-2  |
| 44232S20 | 20    | 2-3  |



**Round plate with wooden platter**

Piatto tondo con tagliere legno  
Platte mit Holzbrett, rund  
Plat rond avec planche bois  
Fuente redonda con tabla madera

| art.     | Ø cm. | lt.  | Por. |
|----------|-------|------|------|
| 44233-16 | 16    | 0,46 | 1-2  |
| 44233-20 | 20    | 0,74 | 3-4  |

**Cups not included. – Ciotoline non incluse.**



**Round pan**

Padella tonda  
Pfanne, rund  
Poêle ronde  
Sartén grill redonda

| art.     | Ø cm. | Por. |
|----------|-------|------|
| 44234-12 | 12    | 1    |
| 44234-16 | 16    | 1-2  |





**Pan and wooden platter**

Padella con tagliere legno  
Pfanne mit Holzbrett  
Poêle avec plaque bois  
Sartén grill con tabla madera

| art.     | Ø cm. | lt.  | Por. |
|----------|-------|------|------|
| 44234S12 | 12    | 0,24 | 1    |
| 44234S16 | 16    | 0,45 | 1-2  |



**Pan and wooden platter**

Padella con tagliere legno  
Pfanne mit Holzbrett  
Poêle avec plaque bois  
Sartén grill con tabla madera

| art.     | Ø cm. | lt.  | Por. |
|----------|-------|------|------|
| 44235-16 | 16    | 0,45 | 1-2  |

**Cups not included.** – Ciotoline non incluse.



**Rectangular pan with wooden service stand**

Tegame con tagliere a servire legno  
Pfanne mit Service-Holzbrett  
Poêle avec support à servir bois  
Sartén con tabla madera

| art.     | cm.   | Por. |
|----------|-------|------|
| 44237S15 | 12x15 | 1-2  |



**Rectangular pan with wooden service stand**

Tegame con tagliere a servire legno  
Pfanne mit Service-Holzbrett  
Poêle avec support à servir bois  
Sartén con tabla madera

| art.     | cm.   | Por. |
|----------|-------|------|
| 44238-15 | 12x15 | 1-2  |

**Cups not included.** – Ciotoline non incluse.



**W**

**Tortillas cup**

Ciotola tortillas  
Tortillas-Schale  
Coupe-tortillas  
Copa tortillas

| art.     | Ø cm. |
|----------|-------|
| 44241-19 | 19    |



**Soufflé pot, enameled cast iron**

Coppa soufflé, ghisa smaltata  
Ramekin, emailliertes Gusseisen  
Ramequin, fonte émaillée  
Fuente soufflé, hierro fundido esmaltado

| art.     | Ø cm. | lt.  | Por. |
|----------|-------|------|------|
| 44240-08 | 8     | 0,15 | 1    |



**PR**

**Sauce bowl**

Coppa salsa  
Saucentasse  
Bol à sauce  
Copa para salsa

| art.     | Ø cm. | h.  |
|----------|-------|-----|
| 44242-00 | 6     | 2,7 |



**MF**

**Sauce bowl**

Coppa salsa  
Saucentasse  
Bol à sauce  
Copa para salsa

| art.     | Ø cm. | h.  |
|----------|-------|-----|
| 44243-00 | 7,1   | 3,5 |



**Oval plate with wooden platter**

Piatto con tagliere legno  
Ovalplatte mit Holzbrett  
Plat oval avec planche bois  
Fuente ovale con tabla madera

| art.     | cm.     | lt.  | Por. |
|----------|---------|------|------|
| 44223S19 | 12,5x19 | 0,23 | 1    |



**Griddle plate, reversible with wooden platter**

Griglia reversibile con tagliere legno  
Grill-Platte, reversible mit Holzbrett  
Gril reversible avec planche bois  
Plancha grill reversible con tabla madera

| art.     | Ø cm. | Por. |
|----------|-------|------|
| 44236S28 | 28    | 4    |
| 44236S34 | 34    | 6    |



**Service dish with wooden stand**

Piatto servire con tagliere legno  
Servierplatte mit Holzbrett  
Plat à servir avec support en bois  
Plato para servir con tabla madera

| art.     | cm.   | Por. |
|----------|-------|------|
| 44245S32 | 32x20 | 1    |



**Service dish with porcelain surface**

Tagliere con superficie porcellanata  
Servierplatte mit Porzellan-Oberfläche  
Plat à servir avec surface en porcelaine  
Tabla con superficie porcelana

| art.     | cm.         | Por. |
|----------|-------------|------|
| 44255-10 | 39,5x25x2,5 | 1    |

**Incl. casserole Ø 10 cm with lid. Sauce cups not included.** – Incl. casseruola c/cop. ø 10 cm. Coppette salsa escluse.



**Service dish with porcelain surface**  
Tagliere con superficie porcellanata  
Servierplatte mit Porzellan-Oberfläche  
Plat à servir avec surface en porcelaine  
Tabla con superficie porcelana

| art.     | cm.         | Por. |
|----------|-------------|------|
| 44255-12 | 39,5x25x2,5 | 1    |

**Incl. oval casserole 12 cm with lid. Sauce cups not included.** – Incl. casseruola ovale c/cop. 12 cm. Coppette salsa escluse.



**Service dish with porcelain surface**  
Tagliere con superficie porcellanata  
Servierplatte mit Porzellan-Oberfläche  
Plat à servir avec surface en porcelaine  
Tabla con superficie porcelana

| art.     | cm.         | Por. |
|----------|-------------|------|
| 44255-14 | 39,5x25x2,5 | 1    |
| 44255-16 | 39,5x25x2,5 | 1-2  |

**Incl. skillet ø 12/16 cm. Sauce cups not included.**  
Incl. padella ø 12/16 cm. Coppette salsa escluse.



**Service dish with porcelain surface**  
Tagliere con superficie porcellanata  
Servierplatte mit Porzellan-Oberfläche  
Plat à servir avec surface en porcelaine  
Tabla con superficie porcelana

| art.     | cm.         | Por. |
|----------|-------------|------|
| 44255-15 | 39,5x25x2,5 | 1-2  |

**Incl. dish 12x15 cm. Sauce cups not included.**  
Incl. tegamino 12x15 cm. Coppette salsa escluse.



**Service dish with porcelain surface**  
Tagliere con superficie porcellanata  
Servierplatte mit Porzellan-Oberfläche  
Plat à servir avec surface en porcelaine  
Tabla con superficie porcelana

| art.     | cm.         | Por. |
|----------|-------------|------|
| 44255-21 | 39,5x25x2,5 | 1-2  |

**Incl. dish 21x14 cm. Sauce cups not included.**  
Incl. tegamino 21x14 cm. Coppette salsa escluse.



**Service dish with porcelain surface**  
Tagliere con superficie porcellanata  
Servierplatte mit Porzellan-Oberfläche  
Plat à servir avec surface en porcelaine  
Tabla con superficie porcelana

| art.     | cm.         | Por. |
|----------|-------------|------|
| 44255-22 | 39,5x25x2,5 | 1-2  |

**Incl. pan ø16 cm. Sauce cups not included.**  
Incl. tegamino ø 16 cm. Coppette salsa escluse.



**Plate pig with wooden platter**  
Piatto maiale con tagliere legno  
Platte Schwein mit Holzbrett  
Plat porc avec planche bois  
Plato cerdo con tabla madera

| art.     | cm.       | lt.  | Por. |
|----------|-----------|------|------|
| 44220S32 | 32,5x17,5 | 0,38 | 1-2  |



**Plate fish with wooden platter**  
Piatto pesce con tagliere legno  
Platte Fisch mit Holzbrett  
Plat poisson avec planche bois  
Plato pescado con tabla madera

| art.     | cm.       | lt.  | Por. |
|----------|-----------|------|------|
| 44220S38 | 24,5x16,5 | 0,12 | 1    |



**Pan with wooden platter**  
Tegame con tagliere legno  
Pfanne mit Holzbrett  
Poêle avec planche bois  
Paellera con tabla madera

| art.     | Ø cm. | cm.       | lt.  | Por. |
|----------|-------|-----------|------|------|
| 44247S16 | 16    | 23,5x18,5 | 0,44 | 1-2  |



**Service dish with porcelain surface**  
Tagliere con superficie porcellanata  
Servierplatte mit Porzellan-Oberfläche  
Plat à servir avec surface en porcelaine  
Tabla con superficie porcelana

| art.     | cm.         | lt.  | Por. |
|----------|-------------|------|------|
| 44255-08 | 39,5x28x4,3 | 0,17 | 1    |

**Incl. dish 16x25 cm. Sauce cups not included.**  
Incl. piatto 16x25cm. Coppette salsa escluse.



**Service dish with wooden stand**  
Piatto servire con tagliere legno  
Servierplatte mit Holzbrett  
Plat à servir avec support en bois  
Plato para servir con tabla madera

| art.     | cm.   | Por. |
|----------|-------|------|
| 44244S30 | 30x15 | 1-2  |
| 44244S36 | 36x24 | 4-6  |



**Hot pot with wooden stand**  
Casseroles con tagliere legno  
Schüssel mit Holzbrett  
Bol avec support en bois  
Bol con tabla madera

| art.     | Ø cm. | h. | lt.  | Por. |
|----------|-------|----|------|------|
| 44246S11 | 11    | 4  | 0,21 | 1    |
| 44246S14 | 14    | 4  | 0,32 | 1    |
| 44246S17 | 17    | 4  | 0,59 | 1    |

# OVEN COOKING DISHES PIROFILE FORNO

PORCELAIN  
PORCELLANA



Only use in the oven or microwave oven, do not place them on direct flame.

Per uso in forni tradizionali e microonde, non mettere le porcellane a diretto contatto con la fiamma.



**Oval dish, fluted**

Pirofila ovale cordonata  
Schale, oval, gerippt  
Plat ovale, cannelé

Fuente oval borderizata

| art.     | cm.         |
|----------|-------------|
| 44371-24 | 24x14x4     |
| 44371-28 | 28x16x4,5   |
| 44371-32 | 32,5x18x5   |
| 44371-36 | 36,5x19,5x5 |
| 44371-40 | 41x23x5,5   |
| 44371-44 | 44x26,5x5,7 |
| 44371-48 | 48x28,5x6,5 |



**Round dish, fluted**

Pirofila rotonda cordonata  
Schale, rund, gerippt  
Plat rond, cannelé

Fuente redonda borderizata

| art.     | Ø cm. |
|----------|-------|
| 44372-26 | 26,5  |
| 44372-32 | 32,0  |
| 44372-36 | 36,0  |
| 44372-40 | 40,0  |



**Rectangular dish, fluted**

Pirofila rettangolare cordonata  
Schale, rechteckig, gerippt  
Plat rectangulaire, cannelé

Fuente rectangular borderizata

| art.     | cm.     |
|----------|---------|
| 44374-22 | 22x16x6 |
| 44374-25 | 25x20x7 |
| 44374-32 | 32x22x6 |
| 44374-36 | 36x24x6 |
| 44374-40 | 40x26x6 |
| 44374-44 | 44x32x6 |



**Oval dish, high, fluted**

Pirofila ovale cordonata, alta  
Schale, oval, gerippt  
Plat oval, cannelé

Fuente oval borderizata, alta

| art.     | cm.       |
|----------|-----------|
| 44389-32 | 32x22x8,5 |



**Rectangular dish, low, fluted**

Rettangolare cordonata, bassa  
Schale, rechteckig, flach, gerippt  
Plat rectangulaire, cannelé

Fuente rect. borderizata, baja

| art.     | cm.     |
|----------|---------|
| 44376-40 | 40x30x4 |



**Square dish, fluted**

Pirofila quadra cordonata  
Schale, quadratisch, gerippt  
Plat carré, cannelé

Fuente cuadrada borderizata

| art.     | cm.     |
|----------|---------|
| 44375-25 | 25x25x6 |



**Egg dish, fluted**

Tegamino cordonato  
Schale, gerippt  
Plat à oeufs, cannelé

Fuente huevo borderizata

| art.     | cm.     |
|----------|---------|
| 44394-18 | 18x21,0 |
| 44394-21 | 21x24,5 |



**Crepe broulée bowl**

Coppetta creme broulée  
Crème broulée Schale  
Coupelle broulée à crème

Bol creme broulée

| art.     | Ø cm. | h. |
|----------|-------|----|
| 44391-12 | 11,6  | 3  |



**Egg dish, high, fluted**

Tegamino fondo, cordonato  
Schale, tief, gerippt  
Plat oeuf, creux, cannelé

Fuente huevo borderizata, alta

| art.     | cm.   |
|----------|-------|
| 44395-18 | 18x20 |



**Soup bowl with cover**

Casseruola con coperchio  
Kasserolle mit Deckel  
Casserole avec couvercle  
Cacerola con tapa

| art.     | cm.   | lt. |
|----------|-------|-----|
| 44397-18 | 14x18 | 0,5 |



**Ramekin, fluted**

Soufflé cordonato  
Ramekin, gerippt  
Ramequin, cannelé

Fuente soufflé borderizata

| art.     | Ø cm. | h.  |
|----------|-------|-----|
| 44390-07 | 7     | 4,0 |
| 44390-09 | 9     | 4,5 |
| 44390-11 | 11    | 6,0 |



**Ramekin, fluted**

Soufflé cordonato  
Ramekin, gerippt  
Ramequin, cannelé

Fuente soufflé borderizata

| art.     | Ø cm. | h.  |
|----------|-------|-----|
| 44390-15 | 15    | 5,0 |
| 44390-18 | 18    | 7,5 |
| 44390-23 | 23    | 8,0 |

# GN FOOD PANS CONTENITORI GN

STAINLESS STEEL, ALUMINUM, POLYCARBONATE, POLYPROPYLENE, MELAMINE AND PORCELAIN  
INOX, ALLUMINIO, POLICARBONATO, POLIPROPILENE, MELAMINA E PORCELLANA



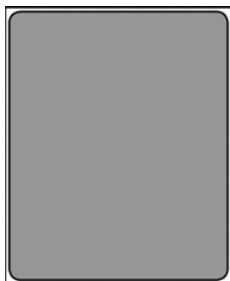

**GN-containers**

GN bacinelle  
GN-Behälter  
GN bacs  
GN cubetas



| art.     | GN  | dim. mm. | h. mm. | lt. |
|----------|-----|----------|--------|-----|
| 14101-02 | 2/1 | 650x530  | 20     | -   |
| 14101-04 | 2/1 | 650x530  | 40     | -   |
| 14101-06 | 2/1 | 650x530  | 65     | 19  |
| 14101-10 | 2/1 | 650x530  | 100    | 31  |
| 14101-15 | 2/1 | 650x530  | 150    | 46  |
| 14101-20 | 2/1 | 650x530  | 200    | 56  |



| art.     | GN  | dim. mm. | h. mm. | lt. |
|----------|-----|----------|--------|-----|
| 14102-02 | 1/1 | 530x325  | 20     | -   |
| 14102-04 | 1/1 | 530x325  | 40     | -   |
| 14102-06 | 1/1 | 530x325  | 65     | 9   |
| 14102-10 | 1/1 | 530x325  | 100    | 14  |
| 14102-15 | 1/1 | 530x325  | 150    | 21  |
| 14102-20 | 1/1 | 530x325  | 200    | 28  |



| art.     | GN  | dim. mm. | h. mm. | lt.  |
|----------|-----|----------|--------|------|
| 14103-02 | 2/3 | 353x320  | 20     | -    |
| 14103-04 | 2/3 | 353x320  | 40     | -    |
| 14103-06 | 2/3 | 353x320  | 65     | 5,5  |
| 14103-10 | 2/3 | 353x320  | 100    | 9,0  |
| 14103-15 | 2/3 | 353x320  | 150    | 13,0 |
| 14103-20 | 2/3 | 353x320  | 200    | 18,0 |

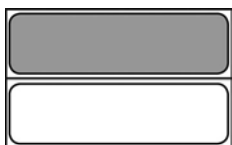

| art.     | GN  | dim. mm. | h. mm. | lt. |
|----------|-----|----------|--------|-----|
| 14104-06 | 2/4 | 162x530  | 65     | 4,0 |
| 14104-10 | 2/4 | 162x530  | 100    | 5,6 |
| 14104-15 | 2/4 | 162x530  | 150    | 8,7 |



| art.     | GN  | dim. mm. | h. mm. | lt.  |
|----------|-----|----------|--------|------|
| 14105-02 | 1/2 | 325x265  | 20     | -    |
| 14105-04 | 1/2 | 325x265  | 40     | -    |
| 14105-06 | 1/2 | 325x265  | 65     | 4,0  |
| 14105-10 | 1/2 | 325x265  | 100    | 6,5  |
| 14105-15 | 1/2 | 325x265  | 150    | 9,5  |
| 14105-20 | 1/2 | 325x265  | 200    | 12,5 |

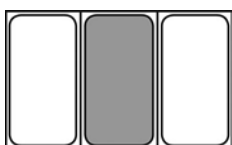

| art.     | GN  | dim. mm. | h. mm. | lt. |
|----------|-----|----------|--------|-----|
| 14107-06 | 1/3 | 325x180  | 65     | 2,5 |
| 14107-10 | 1/3 | 325x180  | 100    | 4,0 |
| 14107-15 | 1/3 | 325x180  | 150    | 5,7 |
| 14107-20 | 1/3 | 325x180  | 200    | 7,8 |



| art.     | GN  | dim. mm. | h. mm. | lt. |
|----------|-----|----------|--------|-----|
| 14108-06 | 1/4 | 265x160  | 65     | 1,8 |
| 14108-10 | 1/4 | 265x160  | 100    | 2,8 |
| 14108-15 | 1/4 | 265x160  | 150    | 4,0 |
| 14108-20 | 1/4 | 265x160  | 200    | 5,5 |



| art.     | GN  | dim. mm. | h. mm. | lt. |
|----------|-----|----------|--------|-----|
| 14109-06 | 1/6 | 176x160  | 65     | 1,0 |
| 14109-10 | 1/6 | 176x160  | 100    | 1,6 |
| 14109-15 | 1/6 | 176x160  | 150    | 2,4 |
| 14109-20 | 1/6 | 176x160  | 200    | 3,4 |



| art.     | GN  | dim. mm. | h. mm. | lt. |
|----------|-----|----------|--------|-----|
| 14110-06 | 1/9 | 176x110  | 65     | 0,6 |
| 14110-10 | 1/9 | 176x110  | 100    | 1,0 |



**GN-containers, fixed handles**

GN bacinelle, maniglie fisse  
GN-Behälter mit festen Griffen

GN bacs, anses fixes  
GN cubetas, asas fijas

| art.     | GN  | dim. mm. | h. mm. | lt.  |
|----------|-----|----------|--------|------|
| 14112-10 | 1/1 | 530x325  | 100    | 14,0 |
| 14112-15 | 1/1 | 530x325  | 150    | 21,0 |
| 14112-20 | 1/1 | 530x325  | 200    | 28,0 |





| art.     | GN  | dim. mm. | h. mm. | lt.  |
|----------|-----|----------|--------|------|
| 14115-10 | 1/2 | 325x265  | 100    | 6,5  |
| 14115-15 | 1/2 | 325x265  | 150    | 9,5  |
| 14115-20 | 1/2 | 325x265  | 200    | 12,5 |

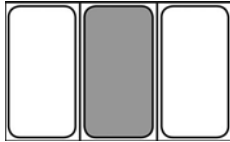

| art.     | GN  | dim. mm. | h. mm. | lt. |
|----------|-----|----------|--------|-----|
| 14117-10 | 1/3 | 325x180  | 100    | 4,0 |
| 14117-15 | 1/3 | 325x180  | 150    | 5,7 |
| 14117-20 | 1/3 | 325x180  | 200    | 7,8 |



| art.     | GN  | dim. mm. | h. mm. | lt. |
|----------|-----|----------|--------|-----|
| 14118-10 | 1/4 | 265x160  | 100    | 2,8 |
| 14118-15 | 1/4 | 265x160  | 150    | 4,0 |
| 14118-20 | 1/4 | 265x160  | 200    | 5,5 |



| art.     | GN  | dim. mm. | h. mm. | lt. |
|----------|-----|----------|--------|-----|
| 14119-10 | 1/6 | 176x160  | 100    | 1,6 |
| 14119-15 | 1/6 | 176x160  | 150    | 2,4 |



**GN-containers, internal handles**  
GN bacinelle, maniglie interne  
GN-Behälter mit Innen Griffen  
GN bacs, anses internes  
GN cubetas, asas internas

| art.     | GN  | dim. mm. | h. mm. | lt.  |
|----------|-----|----------|--------|------|
| 14142-10 | 1/1 | 530x325  | 100    | 14,0 |
| 14142-15 | 1/1 | 530x325  | 150    | 21,0 |
| 14142-20 | 1/1 | 530x325  | 200    | 28,0 |



| art.     | GN  | dim. mm. | h. mm. | lt.  |
|----------|-----|----------|--------|------|
| 14145-10 | 1/2 | 325x265  | 100    | 6,5  |
| 14145-15 | 1/2 | 325x265  | 150    | 9,5  |
| 14145-20 | 1/2 | 325x265  | 200    | 12,5 |

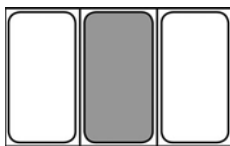

| art.     | GN  | dim. mm. | h. mm. | lt. |
|----------|-----|----------|--------|-----|
| 14147-10 | 1/3 | 325x180  | 100    | 4,0 |
| 14147-15 | 1/3 | 325x180  | 150    | 5,7 |
| 14147-20 | 1/3 | 325x180  | 200    | 7,8 |



| art.     | GN  | dim. mm. | h. mm. | lt. |
|----------|-----|----------|--------|-----|
| 14148-10 | 1/4 | 265x160  | 100    | 2,8 |
| 14148-15 | 1/4 | 265x160  | 150    | 4,0 |
| 14148-20 | 1/4 | 265x160  | 200    | 5,5 |



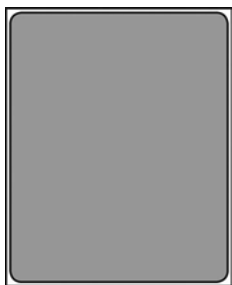

**GN-containers, falling handles**  
GN bacinelle, maniglie rientranti  
GN-Behälter mit versenkbaren Griffen  
GN bacs, anses escamotables  
GN cubetas, asas móviles



| art.     | GN  | dim. mm. | h. mm. | lt.  |
|----------|-----|----------|--------|------|
| 14151-10 | 2/1 | 650x530  | 100    | 31,0 |
| 14151-15 | 2/1 | 650x530  | 150    | 46,0 |
| 14151-20 | 2/1 | 650x530  | 200    | 56,0 |



| art.     | GN  | dim. mm. | h. mm. | lt.  |
|----------|-----|----------|--------|------|
| 14152-06 | 1/1 | 530x325  | 65     | 9,0  |
| 14152-10 | 1/1 | 530x325  | 100    | 14,0 |
| 14152-15 | 1/1 | 530x325  | 150    | 21,0 |
| 14152-20 | 1/1 | 530x325  | 200    | 28,0 |



| art.     | GN  | dim. mm. | h. mm. | lt.  |
|----------|-----|----------|--------|------|
| 14155-10 | 1/2 | 325x265  | 100    | 6,5  |
| 14155-15 | 1/2 | 325x265  | 150    | 9,5  |
| 14155-20 | 1/2 | 325x265  | 200    | 12,5 |

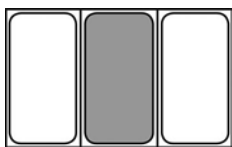

| art.     | GN  | dim. mm. | h. mm. | lt. |
|----------|-----|----------|--------|-----|
| 14157-10 | 1/3 | 325x180  | 100    | 4,0 |
| 14157-15 | 1/3 | 325x180  | 150    | 5,7 |
| 14157-20 | 1/3 | 325x180  | 200    | 7,8 |



| art.     | GN  | dim. mm. | h. mm. | lt. |
|----------|-----|----------|--------|-----|
| 14158-10 | 1/4 | 265x160  | 100    | 2,8 |
| 14158-15 | 1/4 | 265x160  | 150    | 4,0 |
| 14158-20 | 1/4 | 265x160  | 200    | 5,5 |



| art.     | GN  | dim. mm. | h. mm. | lt. |
|----------|-----|----------|--------|-----|
| 14159-10 | 1/6 | 176x160  | 100    | 1,6 |
| 14159-15 | 1/6 | 176x160  | 150    | 2,4 |
| 14159-20 | 1/6 | 176x160  | 200    | 3,4 |



**GN-containers non stick coated**  
GN bacinelle antiaderenti  
GN-Behälter mit Antihafbeschichtung  
GN-bacs avec revêtement anti-adhésif  
GN-cubetas con cobertura antiadherente



| art.     | GN  | dim. mm. | h. mm. |
|----------|-----|----------|--------|
| 14162-02 | 1/1 | 530x325  | 20     |
| 14162-04 | 1/1 | 530x325  | 40     |
| 14162-06 | 1/1 | 530x325  | 65     |



| art.     | GN  | dim. mm. | h. mm. |
|----------|-----|----------|--------|
| 14165-02 | 1/2 | 325x265  | 20     |
| 14165-04 | 1/2 | 325x265  | 40     |
| 14165-06 | 1/2 | 325x265  | 65     |

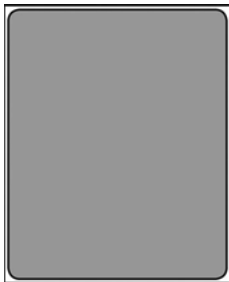

**Perforated GN-containers**

GN bacinelle forate  
Gelochte GN-Behälter  
GN bacs perforés  
GN cubetas perforados



| art.     | GN  | dim. mm. | h. mm. |
|----------|-----|----------|--------|
| 14201-02 | 2/1 | 650x530  | 20     |
| 14201-04 | 2/1 | 650x530  | 40     |
| 14201-06 | 2/1 | 650x530  | 65     |
| 14201-10 | 2/1 | 650x530  | 100    |
| 14201-15 | 2/1 | 650x530  | 150    |
| 14201-20 | 2/1 | 650x530  | 200    |

**Containers depth mm 20 and 40 only bottom perforated. – Bacinelle profondità mm 20 e 40 forate solo sul fondo.**



| art.     | GN  | dim. mm. | h. mm. |
|----------|-----|----------|--------|
| 14202-02 | 1/1 | 530x325  | 20     |
| 14202-04 | 1/1 | 530x325  | 40     |
| 14202-06 | 1/1 | 530x325  | 65     |
| 14202-10 | 1/1 | 530x325  | 100    |
| 14202-15 | 1/1 | 530x325  | 150    |
| 14202-20 | 1/1 | 530x325  | 200    |

**Containers depth mm 20 and 40 only bottom perforated. – Bacinelle profondità mm 20 e 40 forate solo sul fondo.**



| art.     | GN  | dim. mm. | h. mm. |
|----------|-----|----------|--------|
| 14203-06 | 2/3 | 353x320  | 65     |
| 14203-10 | 2/3 | 353x320  | 100    |
| 14203-15 | 2/3 | 353x320  | 150    |
| 14203-20 | 2/3 | 353x320  | 200    |



| art.     | GN  | dim. mm. | h. mm. |
|----------|-----|----------|--------|
| 14205-02 | 1/2 | 325x265  | 20     |
| 14205-04 | 1/2 | 325x265  | 40     |
| 14205-06 | 1/2 | 325x265  | 65     |
| 14205-10 | 1/2 | 325x265  | 100    |
| 14205-15 | 1/2 | 325x265  | 150    |
| 14205-20 | 1/2 | 325x265  | 200    |

**Containers depth mm 20 and 40 only bottom perforated. – Bacinelle profondità mm 20 e 40 forate solo sul fondo.**



**Perforated GN-containers, folding handles**

GN bacinelle forate, maniglie snodate  
Gelochte GN-Behälter mit Fallgriffen  
GN bacs perforés, anses pliantes  
GN cubetas perforados, asas plegables



| art.     | GN  | dim. mm. | h. mm. |
|----------|-----|----------|--------|
| 14252-06 | 1/1 | 530x325  | 65     |
| 14252-10 | 1/1 | 530x325  | 100    |
| 14252-15 | 1/1 | 530x325  | 150    |
| 14252-20 | 1/1 | 530x325  | 200    |



| art.     | GN  | dim. mm. | h. mm. |
|----------|-----|----------|--------|
| 14255-06 | 1/2 | 325x265  | 65     |
| 14255-10 | 1/2 | 325x265  | 100    |
| 14255-15 | 1/2 | 325x265  | 150    |
| 14255-20 | 1/2 | 325x265  | 200    |



**GN-lids**

GN coperchi  
GN-Deckel  
GN couvercles  
GN tapas

| art.     | GN  | dim. mm. |
|----------|-----|----------|
| 14502-00 | 1/1 | 530x325  |
| 14503-00 | 2/3 | 353x320  |
| 14504-00 | 2/4 | 162x530  |
| 14505-00 | 1/2 | 325x265  |
| 14507-00 | 1/3 | 325x180  |
| 14508-00 | 1/4 | 265x160  |
| 14509-00 | 1/6 | 176x160  |
| 14510-00 | 1/9 | 176x110  |



**GN-lids with notched edge for handles**

GN coperchi con spacco maniglie  
GN-Deckel mit Griffen-Ausschnitt  
GN couvercles avec encoche pour anses  
GN tapas con orificio asas

| art.     | GN  | dim. mm. |
|----------|-----|----------|
| 14512-00 | 1/1 | 530x325  |
| 14515-00 | 1/2 | 325x265  |
| 14517-00 | 1/3 | 325x180  |
| 14518-00 | 1/4 | 265x160  |
| 14519-00 | 1/6 | 176x160  |



**GN-lids with notched edge for ladle**

GN coperchi con spacco mestolo  
GN-Deckel mit Löffel-Ausschnitt  
GN couvercles avec encoche pour louche  
GN tapas con orificio cacillo

| art.     | GN  | dim. mm. |
|----------|-----|----------|
| 14522-00 | 1/1 | 530x325  |
| 14523-00 | 2/3 | 353x320  |
| 14525-00 | 1/2 | 325x265  |
| 14527-00 | 1/3 | 325x180  |
| 14528-00 | 1/4 | 265x160  |
| 14529-00 | 1/6 | 176x160  |



**GN-lids with notched edge for handles/ladle**

GN coperchi con spacco maniglie/mestolo  
GN-Deckel mit Griffen u. Löffel-Ausschnitt  
GN couvercles avec encoche pour anses/louche  
GN tapas con orificio asas/cacillo

| art.     | GN  | dim. mm. |
|----------|-----|----------|
| 14532-00 | 1/1 | 530x325  |
| 14535-00 | 1/2 | 325x265  |
| 14537-00 | 1/3 | 325x180  |
| 14538-00 | 1/4 | 265x160  |
| 14539-00 | 1/6 | 176x160  |



**GN-lids with silicone seal**

GN coperchi con guarnizione silicone  
GN-Deckel mit Silikondichtung  
GN couvercles avec joint silicone  
GN tapas con junta de silicona

| art.     | GN  | dim. mm. |
|----------|-----|----------|
| 14542-00 | 1/1 | 530x325  |
| 14543-00 | 2/3 | 353x320  |
| 14545-00 | 1/2 | 325x265  |
| 14547-00 | 1/3 | 325x180  |
| 14548-00 | 1/4 | 265x160  |
| 14549-00 | 1/6 | 176x160  |





**GN-lids with notched edge for handles and seal**  
GN coperchi con spacco maniglie e guarnizione  
GN-Deckel mit Griffen-Ausschnitt u. Silikondichtung  
GN couvercles avec encoche pour anses et joint  
GN tapas con orificio asas y junta

| art.     | GN  | dim. mm. |
|----------|-----|----------|
| 14552-00 | 1/1 | 530x325  |
| 14555-00 | 1/2 | 325x265  |

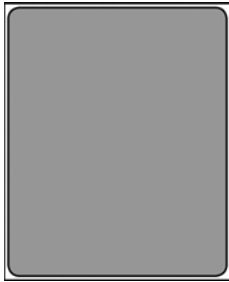

**GN-baking sheets**

GN-teglie  
GN-Backbleche  
GN-plaques  
GN-bandejas



| art.     | GN  | dim. mm. | h. mm. |
|----------|-----|----------|--------|
| 14301-02 | 2/1 | 650x530  | 20     |
| 14301-04 | 2/1 | 650x530  | 40     |
| 14301-06 | 2/1 | 650x530  | 65     |



| art.     | GN  | dim. mm. | h. mm. |
|----------|-----|----------|--------|
| 14302-02 | 1/1 | 530x325  | 20     |
| 14302-04 | 1/1 | 530x325  | 40     |
| 14302-06 | 1/1 | 530x325  | 65     |



| art.     | GN  | dim. mm. | h. mm. |
|----------|-----|----------|--------|
| 14303-02 | 2/3 | 353x320  | 20     |
| 14303-04 | 2/3 | 353x320  | 40     |
| 14303-06 | 2/3 | 353x320  | 65     |



| art.     | GN  | dim. mm. | h. mm. |
|----------|-----|----------|--------|
| 14305-02 | 1/2 | 325x265  | 20     |
| 14305-04 | 1/2 | 325x265  | 40     |
| 14305-06 | 1/2 | 325x265  | 65     |



**GN-baking sheets non stick coated**

GN-teglie con rivestimento antiaderente  
GN-Backbleche mit Antihafbeschichtung  
GN-plaques avec revêtement anti-adhésif  
GN-bandejas con cobertura antiadherente



| art.     | GN  | dim. mm. | h. mm. |
|----------|-----|----------|--------|
| 14362-02 | 1/1 | 530x325  | 20     |
| 14362-04 | 1/1 | 530x325  | 40     |
| 14362-06 | 1/1 | 530x325  | 65     |



| art.     | GN  | dim. mm. | h. mm. |
|----------|-----|----------|--------|
| 14365-02 | 1/2 | 325x265  | 20     |
| 14365-04 | 1/2 | 325x265  | 40     |
| 14365-06 | 1/2 | 325x265  | 65     |



**GN-baking sheets, ALUMINIUM**

GN-teglie, ALLUMINIO  
GN-Backbleche, ALUMINIUM  
GN-plaques, ALUMINIUM  
GN-bandejas, ALUMINIO



| art.     | GN  | dim. mm. | h. mm. |
|----------|-----|----------|--------|
| 16302-02 | 1/1 | 530x325  | 20     |
| 16302-04 | 1/1 | 530x325  | 40     |
| 16302-06 | 1/1 | 530x325  | 65     |



| art.     | GN  | dim. mm. | h. mm. |
|----------|-----|----------|--------|
| 16303-02 | 2/3 | 353x320  | 20     |
| 16303-04 | 2/3 | 353x320  | 40     |
| 16303-06 | 2/3 | 353x320  | 65     |



| art.     | GN  | dim. mm. | h. mm. |
|----------|-----|----------|--------|
| 16305-02 | 1/2 | 325x265  | 20     |
| 16305-04 | 1/2 | 325x265  | 40     |
| 16305-06 | 1/2 | 325x265  | 65     |



**GN-baking sheets, ALUMINIUM non stick coated**

GN-teglie, ALLUMINIO antiaderente  
GN-Backbleche, ALUMINIUM mit Antihafbeschichtung  
GN-plaques, ALUMINIUM avec revêtement anti-adhésif  
GN-bandejas, ALUMINIO con cobertura antiadherente



| art.     | GN  | dim. mm. | h. mm. |
|----------|-----|----------|--------|
| 16362-02 | 1/1 | 530x325  | 20     |
| 16362-04 | 1/1 | 530x325  | 40     |
| 16362-06 | 1/1 | 530x325  | 65     |



| art.     | GN  | dim. mm. | h. mm. |
|----------|-----|----------|--------|
| 16363-02 | 2/3 | 353x320  | 20     |
| 16363-04 | 2/3 | 353x320  | 40     |
| 16363-06 | 2/3 | 353x320  | 65     |



| art.     | GN  | dim. mm. | h. mm. |
|----------|-----|----------|--------|
| 16365-02 | 1/2 | 325x265  | 20     |
| 16365-04 | 1/2 | 325x265  | 40     |
| 16365-06 | 1/2 | 325x265  | 65     |



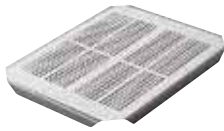

**Drainer plate**  
Falso fondo forato  
Abtropfplatte  
Plateau double fond perforé  
Fondo perforado

| art.     | GN  |
|----------|-----|
| 14402-00 | 1/1 |
| 14405-00 | 1/2 |
| 14407-00 | 1/3 |



**Adaptor bar**  
Separatore  
StegeAdapter/Zwischensteg  
Barrette de composition  
Adaptador

| art.     | GN  | dim. mm. |
|----------|-----|----------|
| 14409-01 | 1/1 | 325      |
| 14409-02 | 2/1 | 530      |



**Pan, enamelled**  
Teglia smaltata  
Ofenblech, emalliert  
Bac émaillé  
Cubeta esmaltada

| art.     | GN  | dim. mm. | h. mm. | lt. |
|----------|-----|----------|--------|-----|
| 44322-02 | 1/1 | 530x325  | 20     | 2,5 |
| 44322-04 | 1/1 | 530x325  | 40     | 5,0 |
| 44322-06 | 1/1 | 530x325  | 65     | 9,0 |

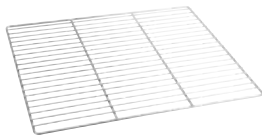

**Wire grid**  
Griglia in filo  
Gastronormrost  
Grille  
Rejilla

| art.     | GN  | dim. mm. |
|----------|-----|----------|
| 44412-00 | 1/2 | 325x265  |
| 44423-00 | 2/3 | 353x320  |
| 44421-00 | 2/1 | 650x530  |



**Wire grid with edge**  
Griglia in filo con sponda  
Gastronormrost mit Seitenwand  
Grille avec arrêt  
Rejilla con borde

| art.     | GN  | dim. mm. |
|----------|-----|----------|
| 44422-00 | 1/1 | 530x325  |

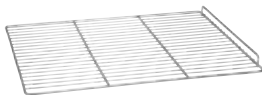

**Wire grid with edge**  
Griglia in filo con sponda  
Gastronormrost mit Seitenwand  
Grille avec arrêt  
Rejilla con borde

| art.     | GN  | dim. mm. |
|----------|-----|----------|
| 44432-21 | 2/1 | 650x530  |



**Fry basket**  
Cesta per friggere  
Frittier-Korb  
Panier à frire  
Cesta escurrefrito

| art.     | GN  | dim. mm. | h. mm. |
|----------|-----|----------|--------|
| 11750-11 | 1/1 | 530x325  | 60     |



**Grid enamelled**  
Griglia smaltata  
Rost, emalliert  
Grille émaillé  
Rejilla esmaltada

| art.     | GN  | dim. mm. |
|----------|-----|----------|
| 11760-11 | 1/1 | 530x325  |

# POLYCARBONATE POLICARBONATO

GN FOOD PANS  
CONTENITORI GN



Withstands temperatures from **-40°C to +100°C**. With metric graduation.  
Stackable, ideal for storage, transportation and serving display.

Termoresistenti da **-40°C a +100°C**. Con scala graduata in litri. Impilabili, sono ideali per la conservazione, trasporto ed esposizione.

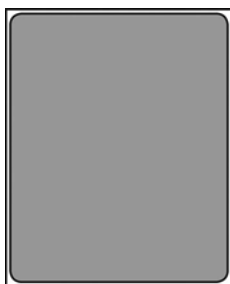

## GN-containers

GN bacinelle  
GN-Behälter  
GN bacs  
GN cubetas

| art.     | GN  | dim. mm. | h. mm. | lt. |
|----------|-----|----------|--------|-----|
| 14561-15 | 2/1 | 650x530  | 150    | 42  |
| 14561-20 | 2/1 | 650x530  | 200    | 52  |



| art.     | GN  | dim. mm. | h. mm. | lt.  |
|----------|-----|----------|--------|------|
| 14562-06 | 1/1 | 530x325  | 65     | 8,5  |
| 14562-10 | 1/1 | 530x325  | 100    | 13,0 |
| 14562-15 | 1/1 | 530x325  | 150    | 19,5 |
| 14562-20 | 1/1 | 530x325  | 200    | 26,0 |



| art.     | GN  | dim. mm. | h. mm. | lt.  |
|----------|-----|----------|--------|------|
| 14565-06 | 1/2 | 325x265  | 65     | 3,9  |
| 14565-10 | 1/2 | 325x265  | 100    | 5,9  |
| 14565-15 | 1/2 | 325x265  | 150    | 8,9  |
| 14565-20 | 1/2 | 325x265  | 200    | 11,8 |



| art.     | GN  | dim. mm. | h. mm. | lt. |
|----------|-----|----------|--------|-----|
| 14567-06 | 1/3 | 325x180  | 65     | 2,4 |
| 14567-10 | 1/3 | 325x180  | 100    | 3,6 |
| 14567-15 | 1/3 | 325x180  | 150    | 5,3 |
| 14567-20 | 1/3 | 325x180  | 200    | 7,0 |



| art.     | GN  | dim. mm. | h. mm. | lt. |
|----------|-----|----------|--------|-----|
| 14568-06 | 1/4 | 265x160  | 65     | 1,7 |
| 14568-10 | 1/4 | 265x160  | 100    | 2,5 |
| 14568-15 | 1/4 | 265x160  | 150    | 3,7 |
| 14568-20 | 1/4 | 265x160  | 200    | 5,5 |



| art.     | GN  | dim. mm. | h. mm. | lt. |
|----------|-----|----------|--------|-----|
| 14569-06 | 1/6 | 176x160  | 65     | 1,0 |
| 14569-10 | 1/6 | 176x160  | 100    | 1,5 |
| 14569-15 | 1/6 | 176x160  | 150    | 2,2 |
| 14569-20 | 1/6 | 176x160  | 200    | 3,4 |



| art.     | GN  | dim. mm. | h. mm. | lt. |
|----------|-----|----------|--------|-----|
| 14570-06 | 1/9 | 176x110  | 65     | 0,6 |
| 14570-10 | 1/9 | 176x110  | 100    | 1,0 |



**GN-lid without handle**  
GN coperchio senza traversino  
GN-Deckel ohne Griff  
GN couvercle sans poignée  
GN tapa sin asa

| art.     | GN  | dim. mm. |
|----------|-----|----------|
| 14571-00 | 2/1 | 650x530  |



**GN-lids with handle**  
GN coperchi con traversino  
GN-Deckel mit Griff  
GN couvercles avec poignée  
GN tapas con asa

| art.     | GN  | dim. mm. |
|----------|-----|----------|
| 14572-00 | 1/1 | 530x325  |
| 14575-00 | 1/2 | 325x265  |
| 14577-00 | 1/3 | 325x180  |
| 14578-00 | 1/4 | 265x160  |
| 14579-00 | 1/6 | 176x160  |
| 14580-00 | 1/9 | 176x110  |



**GN-lid with silicone seal**  
GN coperchio con guarnizione silicone  
GN-Deckel mit Silikondichtung  
GN couvercle avec joint silicone  
GN tapa con junta de silicona

| art.     | GN  | dim. mm. |
|----------|-----|----------|
| 14585-00 | 1/2 | 325x265  |



**Drainer plate**  
Falso fondo forato  
Abtropfplatte  
Plateau double fond perforé  
Fondo perforado

| art.     | GN  | dim. mm. |
|----------|-----|----------|
| 14591-00 | 2/1 | 650x530  |
| 14592-00 | 1/1 | 530x325  |
| 14595-00 | 1/2 | 325x265  |
| 14597-00 | 1/3 | 325x180  |
| 14598-00 | 1/4 | 265x160  |
| 14599-00 | 1/6 | 176x160  |



# TRITAN BPA FREE

GN FOOD PANS  
CONTENITORI GN



**TRITAN - COPOLYMER - BPA FREE -40°C+90°C.**  
The lids of the series 14800 polycarbonate and 14600 Tritan are interchangeable. Hermetic lids, NOT water-tight.

**TRITAN COPOLIMERO - BPA FREE -40°C+90°C.**  
I coperchi della serie 14800 policarbonato e 14600 Tritan sono intercambiabili. Coperchi ermetici, NON a tenuta stagna.

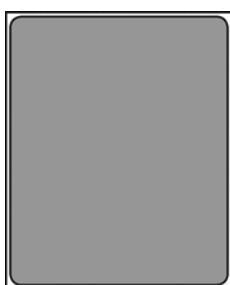

**GN-containers**  
GN bacinelle  
GN-Behälter  
GN bacs  
GN cubetas

| art.     | GN  | dim. mm. | h. mm. | lt.  |
|----------|-----|----------|--------|------|
| 14661-20 | 2/1 | 650x530  | 200    | 55,5 |

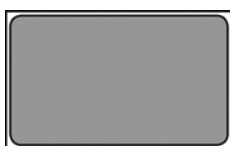

| art.     | GN  | dim. mm. | h. mm. | lt.  |
|----------|-----|----------|--------|------|
| 14662-06 | 1/1 | 530x325  | 65     | 9,0  |
| 14662-10 | 1/1 | 530x325  | 100    | 13,3 |
| 14662-15 | 1/1 | 530x325  | 150    | 20,0 |
| 14662-20 | 1/1 | 530x325  | 200    | 26,4 |



| art.     | GN  | dim. mm. | h. mm. | lt.  |
|----------|-----|----------|--------|------|
| 14665-06 | 1/2 | 325x265  | 65     | 4,0  |
| 14665-10 | 1/2 | 325x265  | 100    | 6,1  |
| 14665-15 | 1/2 | 325x265  | 150    | 9,0  |
| 14665-20 | 1/2 | 325x265  | 200    | 11,9 |



| art.     | GN  | dim. mm. | h. mm. | lt. |
|----------|-----|----------|--------|-----|
| 14667-06 | 1/3 | 325x175  | 65     | 2,5 |
| 14667-10 | 1/3 | 325x175  | 100    | 3,8 |
| 14667-15 | 1/3 | 325x175  | 150    | 5,5 |
| 14667-20 | 1/3 | 325x175  | 200    | 7,1 |



| art.     | GN  | dim. mm. | h. mm. | lt. |
|----------|-----|----------|--------|-----|
| 14668-06 | 1/4 | 264x162  | 65     | 1,7 |
| 14668-10 | 1/4 | 264x162  | 100    | 2,6 |
| 14668-15 | 1/4 | 264x162  | 150    | 3,8 |
| 14668-20 | 1/4 | 264x162  | 200    | 4,8 |



| art.     | GN  | dim. mm. | h. mm. | lt. |
|----------|-----|----------|--------|-----|
| 14669-06 | 1/6 | 176x162  | 65     | 1,0 |
| 14669-10 | 1/6 | 176x162  | 100    | 1,6 |
| 14669-15 | 1/6 | 176x162  | 150    | 2,3 |
| 14669-20 | 1/6 | 176x162  | 200    | 2,8 |



| art.     | GN  | dim. mm. | h. mm. | lt. |
|----------|-----|----------|--------|-----|
| 14670-06 | 1/9 | 176x108  | 65     | 0,6 |
| 14670-10 | 1/9 | 176x108  | 100    | 0,9 |



**GN-lids**  
GN-coperchi  
GN-Deckel  
GN couvercles  
GN tapas

| art.     | GN  | dim. mm. |
|----------|-----|----------|
| 14671-00 | 2/1 | 650x530  |
| 14672-00 | 1/1 | 530x325  |
| 14675-00 | 1/2 | 325x265  |
| 14677-00 | 1/3 | 325x175  |
| 14678-00 | 1/4 | 264x162  |
| 14679-00 | 1/6 | 176x162  |
| 14680-00 | 1/9 | 176x108  |



**GN-lids, hermetic**  
GN coperchi ermetici  
GN-Deckel, hermetisch  
GN couvercles hermétiques  
GN tapas herméticas

| art.     | GN  | dim. mm. |
|----------|-----|----------|
| 14682-00 | 1/1 | 530x325  |
| 14685-00 | 1/2 | 325x265  |
| 14687-00 | 1/3 | 325x175  |
| 14688-00 | 1/4 | 264x162  |
| 14689-00 | 1/6 | 176x162  |
| 14690-00 | 1/9 | 176x108  |



**Drainer plate**  
Falso fondo forato  
Abtropfplatte  
Plateau double fond perforé  
Fondo perforado

| art.     | GN  | dim. mm. |
|----------|-----|----------|
| 14691-00 | 2/1 | 650x530  |
| 14692-00 | 1/1 | 530x325  |
| 14695-00 | 1/2 | 325x265  |

# POLYPROPYLENE POLIPROPILENE

GN FOOD PANS  
CONTENITORI GN



Transparent and stackable. Dish-washer safe. Do not use abrasive sponges and substances. Cold resistant up to  $-40^{\circ}\text{C}$ . Heat resistant up to  $+75^{\circ}\text{C}$ . Graduation scale in liters. Lids tightly fitting.

Traslucide e impilabili. Lavabili in lavastoviglie con normali detersivi. Non utilizzare pagliette e sostanze abrasive. Termoresistenti da  $-40^{\circ}\text{C}$  a  $+75^{\circ}\text{C}$ . Scala di graduazione in litri. Coperchio resistente per una perfetta chiusura stagna.



**GN-containers**

GN bacinelle  
GN-Behälter  
GN bacs  
GN cubetas

| art.     | GN  | dim. mm. | h. mm. | lt.  |
|----------|-----|----------|--------|------|
| 14702-06 | 1/1 | 530x325  | 65     | 8,5  |
| 14702-10 | 1/1 | 530x325  | 100    | 13,0 |
| 14702-15 | 1/1 | 530x325  | 150    | 19,5 |
| 14702-20 | 1/1 | 530x325  | 200    | 26,0 |



| art.     | GN  | dim. mm. | h. mm. | lt.  |
|----------|-----|----------|--------|------|
| 14705-06 | 1/2 | 325x265  | 65     | 3,9  |
| 14705-10 | 1/2 | 325x265  | 100    | 5,9  |
| 14705-15 | 1/2 | 325x265  | 150    | 8,9  |
| 14705-20 | 1/2 | 325x265  | 200    | 11,8 |

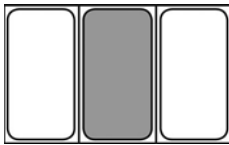

| art.     | GN  | dim. mm. | h. mm. | lt. |
|----------|-----|----------|--------|-----|
| 14707-06 | 1/3 | 325x180  | 65     | 2,4 |
| 14707-10 | 1/3 | 325x180  | 100    | 3,6 |
| 14707-15 | 1/3 | 325x180  | 150    | 5,3 |
| 14707-20 | 1/3 | 325x180  | 200    | 7,0 |



| art.     | GN  | dim. mm. | h. mm. | lt. |
|----------|-----|----------|--------|-----|
| 14708-06 | 1/4 | 265x160  | 65     | 1,7 |
| 14708-10 | 1/4 | 265x160  | 100    | 2,5 |
| 14708-15 | 1/4 | 265x160  | 150    | 3,7 |
| 14708-20 | 1/4 | 265x160  | 200    | 5,5 |



| art.     | GN  | dim. mm. | h. mm. | lt. |
|----------|-----|----------|--------|-----|
| 14709-06 | 1/6 | 176x160  | 65     | 1,0 |
| 14709-10 | 1/6 | 176x160  | 100    | 1,5 |
| 14709-15 | 1/6 | 176x160  | 150    | 2,2 |
| 14709-20 | 1/6 | 176x160  | 200    | 3,4 |



| art.     | GN  | dim. mm. | h. mm. | lt. |
|----------|-----|----------|--------|-----|
| 14710-06 | 1/9 | 176x110  | 65     | 1,3 |
| 14710-10 | 1/9 | 176x110  | 100    | 0,8 |



**Drainer plate**

Falso fondo forato  
Abtropfplatte  
Plateau double fond perforé  
Fondo perforado

| art.     | GN  | dim. mm. | h. mm. |
|----------|-----|----------|--------|
| 14712-00 | 1/1 | 471x266  | 16     |
| 14715-00 | 1/2 | 266x206  | 16     |
| 14717-00 | 1/3 | 266x117  | 16     |
| 14718-00 | 1/4 | 207x103  | 16     |
| 14719-00 | 1/6 | 117x103  | 16     |



**GN-lids**  
GN-coperchi  
GN-Deckel  
GN couvercles  
GN tapas

| art.     | GN  | dim. mm. | col. |
|----------|-----|----------|------|
| 14722-00 | 1/1 | 530x325  | ●    |
| 14722-11 | 1/1 | 530x325  | ●    |
| 14722-22 | 1/1 | 530x325  | ●    |
| 14722-33 | 1/1 | 530x325  | ●    |
| 14722-99 | 1/1 | 530x325  | ○    |



| art.     | GN  | dim. mm. | col. |
|----------|-----|----------|------|
| 14725-00 | 1/2 | 325x265  | ●    |
| 14725-11 | 1/2 | 325x265  | ●    |
| 14725-22 | 1/2 | 325x265  | ●    |
| 14725-33 | 1/2 | 325x265  | ●    |
| 14725-99 | 1/2 | 325x265  | ○    |



| art.     | GN  | dim. mm. | col. |
|----------|-----|----------|------|
| 14727-00 | 1/3 | 325x180  | ●    |
| 14727-11 | 1/3 | 325x180  | ●    |
| 14727-22 | 1/3 | 325x180  | ●    |
| 14727-33 | 1/3 | 325x180  | ●    |
| 14727-99 | 1/3 | 325x180  | ○    |



| art.     | GN  | dim. mm. | col. |
|----------|-----|----------|------|
| 14728-00 | 1/4 | 265x160  | ●    |
| 14728-11 | 1/4 | 265x160  | ●    |
| 14728-22 | 1/4 | 265x160  | ●    |
| 14728-33 | 1/4 | 265x160  | ●    |
| 14728-99 | 1/4 | 265x160  | ○    |



| art.     | GN  | dim. mm. | col. |
|----------|-----|----------|------|
| 14729-00 | 1/6 | 176x160  | ●    |
| 14729-11 | 1/6 | 176x160  | ●    |
| 14729-22 | 1/6 | 176x160  | ●    |
| 14729-33 | 1/6 | 176x160  | ●    |
| 14729-99 | 1/6 | 176x160  | ○    |



| art.     | GN  | dim. mm. | col. |
|----------|-----|----------|------|
| 14730-00 | 1/9 | 176x110  | ●    |
| 14730-11 | 1/9 | 176x110  | ●    |
| 14730-22 | 1/9 | 176x110  | ●    |
| 14730-33 | 1/9 | 176x110  | ●    |
| 14730-99 | 1/9 | 176x110  | ○    |



# IML POLYPROPYLENE POLIPROPILENE IML

GN FOOD PANS  
CONTENITORI GN



With permanent in molded label. To write on the label there is a specific marker that can be removed by simply washing in the dishwasher. Withstand temperatures from -40°C to +80°C. With both metric and American graduated scale. **WARNING:** polypropylene containers are not suitable for use on steam tables.

Con etichetta permanente costampata. Per scrivere sull'etichetta è disponibile un pennarello specifico che viene rimosso con il semplice lavaggio in lavastoviglie. Termoresistenti da -40°C a +80°C. Scala graduata sia secondo sistema metrico che americano. **AVVERTENZE:** i contenitori in polipropilene non sono indicati per l'uso su tavole a vapore.



**GN-containers**

GN bacinelle  
GN-Behälter  
GN bacs  
GN cubetas

| art.     | GN  | dim. mm. | h. mm. | lt.  |
|----------|-----|----------|--------|------|
| 15101-06 | 1/1 | 530x325  | 65     | 9,0  |
| 15101-10 | 1/1 | 530x325  | 100    | 13,3 |
| 15101-15 | 1/1 | 530x325  | 150    | 20,0 |
| 15101-20 | 1/1 | 530x325  | 200    | 26,4 |



| art.     | GN  | dim. mm. | h. mm. | lt.  |
|----------|-----|----------|--------|------|
| 15105-06 | 1/2 | 325x265  | 65     | 4,0  |
| 15105-10 | 1/2 | 325x265  | 100    | 6,1  |
| 15105-15 | 1/2 | 325x265  | 150    | 9,0  |
| 15105-20 | 1/2 | 325x265  | 200    | 11,9 |

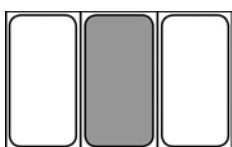

| art.     | GN  | dim. mm. | h. mm. | lt. |
|----------|-----|----------|--------|-----|
| 15107-06 | 1/3 | 325x175  | 65     | 2,5 |
| 15107-10 | 1/3 | 325x175  | 100    | 3,8 |
| 15107-15 | 1/3 | 325x175  | 150    | 5,5 |
| 15107-20 | 1/3 | 325x175  | 200    | 7,1 |



| art.     | GN  | dim. mm. | h. mm. | lt. |
|----------|-----|----------|--------|-----|
| 15108-06 | 1/4 | 264x162  | 65     | 1,7 |
| 15108-10 | 1/4 | 264x162  | 100    | 2,6 |
| 15108-15 | 1/4 | 264x162  | 150    | 3,8 |
| 15108-20 | 1/4 | 264x162  | 200    | 4,8 |



| art.     | GN  | dim. mm. | h. mm. | lt. |
|----------|-----|----------|--------|-----|
| 15109-06 | 1/6 | 176x162  | 65     | 1,0 |
| 15109-10 | 1/6 | 176x162  | 100    | 1,6 |
| 15109-15 | 1/6 | 176x162  | 150    | 2,3 |
| 15109-20 | 1/6 | 176x162  | 200    | 2,8 |



| art.     | GN  | dim. mm. | h. mm. | lt. |
|----------|-----|----------|--------|-----|
| 15110-06 | 1/9 | 176x108  | 65     | 0,6 |
| 15110-10 | 1/9 | 176x108  | 100    | 0,9 |



**Drainer plate**

Falso fondo forato  
Abtropfplatte  
Plateau double fond perforé  
Fondo perforado

| art.     | GN  | dim. mm. |
|----------|-----|----------|
| 14912-00 | 1/1 | 530x325  |
| 14915-00 | 1/2 | 325x265  |



**GN-lids, hermetic with GASKET**

GN coperchi ermetici con GUARNIZIONE  
GN-Deckel, hermetisch mit Dichtung  
GN couvercles hermétiques avec joint  
GN tapas herméticas con junta

| art.     | GN  | dim. mm. |
|----------|-----|----------|
| 14942-99 | 1/1 | 530x325  |
| 14945-99 | 1/2 | 325x265  |
| 14947-99 | 1/3 | 325x175  |

**NEW**

**GN-lids**  
GN coperchi  
GN-Deckel  
GN couvercles  
GN tapas



| art.     | GN  | dim. mm. | col.  |
|----------|-----|----------|-------|
| 14922-00 | 1/1 | 530x325  | ●     |
| 14922-11 | 1/1 | 530x325  | ●     |
| 14922-22 | 1/1 | 530x325  | ●     |
| 14922-33 | 1/1 | 530x325  | ●     |
| 14922-77 | 1/1 | 530x325  | ● NEW |
| 14922-99 | 1/1 | 530x325  | ○     |



| art.     | GN  | dim. mm. | col.  |
|----------|-----|----------|-------|
| 14925-00 | 1/2 | 325x265  | ●     |
| 14925-11 | 1/2 | 325x265  | ●     |
| 14925-22 | 1/2 | 325x265  | ●     |
| 14925-33 | 1/2 | 325x265  | ●     |
| 14925-77 | 1/2 | 325x265  | ● NEW |
| 14925-99 | 1/2 | 325x265  | ○     |



| art.     | GN  | dim. mm. | col.  |
|----------|-----|----------|-------|
| 14927-00 | 1/3 | 325x175  | ●     |
| 14927-11 | 1/3 | 325x175  | ●     |
| 14927-22 | 1/3 | 325x175  | ●     |
| 14927-33 | 1/3 | 325x175  | ●     |
| 14927-77 | 1/3 | 325x175  | ● NEW |
| 14927-99 | 1/3 | 325x175  | ○     |



| art.     | GN  | dim. mm. | col.  |
|----------|-----|----------|-------|
| 14928-00 | 1/4 | 264x162  | ●     |
| 14928-11 | 1/4 | 264x162  | ●     |
| 14928-22 | 1/4 | 264x162  | ●     |
| 14928-33 | 1/4 | 264x162  | ●     |
| 14928-77 | 1/4 | 264x162  | ● NEW |
| 14928-99 | 1/4 | 264x162  | ○     |



| art.     | GN  | dim. mm. | col.  |
|----------|-----|----------|-------|
| 14929-00 | 1/6 | 176x162  | ●     |
| 14929-11 | 1/6 | 176x162  | ●     |
| 14929-22 | 1/6 | 176x162  | ●     |
| 14929-33 | 1/6 | 176x162  | ●     |
| 14929-77 | 1/6 | 176x162  | ● NEW |
| 14929-99 | 1/6 | 176x162  | ○     |



| art.     | GN  | dim. mm. | col.  |
|----------|-----|----------|-------|
| 14930-00 | 1/9 | 176x108  | ●     |
| 14930-11 | 1/9 | 176x108  | ●     |
| 14930-22 | 1/9 | 176x108  | ●     |
| 14930-33 | 1/9 | 176x108  | ●     |
| 14930-77 | 1/9 | 176x108  | ● NEW |
| 14930-99 | 1/9 | 176x108  | ○     |





**Clips for lids**  
Clips per coperchi  
Clips für Deckel  
Clips pour couvercles  
Clips para tapas

| art.     | U. Pack | col.  |
|----------|---------|-------|
| 15100-01 | 12      | ●     |
| 15100-02 | 12      | ●     |
| 15100-03 | 12      | ●     |
| 15100-04 | 12      | ●     |
| 15100-07 | 12      | ● NEW |



**Kit 2 markers**  
Set 2 pennarelli  
Satz 2 Marker  
Set 2 marqueurs  
Juego 2 marcadores

art.  
15100-AA





Melamine is suitable for hot and cold food use. Melamine is suitable for food storage at ambient or chilled temperatures for up to 24 hours. Melamine is not suitable for hot counters, displays, or heated cabinets. Do not expose melamine to direct flame or heat, including heat lamps and plate warmers. Temperature rating is between -20°C and 70°C (-4°F +158°F).

La melamina è adatta per l'uso sia con cibi caldi che freddi. La melamina è adatta per la conservazione degli alimenti a temperatura ambiente o refrigerata fino a 24 ore. La melamina non è adatta per piani caldi, espositori o armadi riscaldati. Non esporre a calore e fiamme dirette, incluse lampade alogene e scaldapiatti. Non esporre gli oggetti in melamina a temperature superiori a 70°C (-20°C +70°C).

GN-containers / Bacinelle / Behälter / Bacs / Cubetas



| art.     | GN  | dim. mm. | h. mm. | lt.  | col. |
|----------|-----|----------|--------|------|------|
| 44877-11 | 1/1 | 530X325  | 65     | 7,1  | ○    |
| 44877B11 | 1/1 | 530X325  | 100    | 10,6 | ○    |
| 44878-11 | 1/1 | 530X325  | 65     | 7,1  | ●    |
| 44878B11 | 1/1 | 530X325  | 100    | 10,6 | ●    |



| art.     | GN  | dim. mm. | h. mm. | lt. | col. |
|----------|-----|----------|--------|-----|------|
| 44877-24 | 2/4 | 160x530  | 65     | 3,0 | ○    |
| 44877B24 | 2/4 | 160x530  | 100    | 4,3 | ○    |
| 44878-24 | 2/4 | 160x530  | 65     | 3,0 | ●    |
| 44878B24 | 2/4 | 160x530  | 100    | 4,3 | ●    |



| art.     | GN  | dim. mm. | h. mm. | lt. | col. |
|----------|-----|----------|--------|-----|------|
| 44877-12 | 1/2 | 325X265  | 65     | 3,4 | ○    |
| 44877B12 | 1/2 | 325X265  | 100    | 4,7 | ○    |
| 44878-12 | 1/2 | 325X265  | 65     | 3,4 | ●    |
| 44878B12 | 1/2 | 325X265  | 100    | 4,7 | ●    |

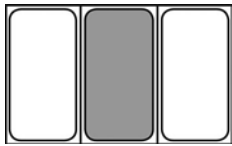

| art.     | GN  | dim. mm. | h. mm. | lt. | col. |
|----------|-----|----------|--------|-----|------|
| 44877-13 | 1/3 | 325X175  | 65     | 2,0 | ○    |
| 44877B13 | 1/3 | 325X175  | 100    | 2,7 | ○    |
| 44878-13 | 1/3 | 325X175  | 65     | 2,0 | ●    |
| 44878B13 | 1/3 | 325X175  | 100    | 2,7 | ●    |



| art.     | GN  | dim. mm. | h. mm. | lt. | col. |
|----------|-----|----------|--------|-----|------|
| 44877-14 | 1/4 | 265X160  | 65     | 1,4 | ○    |
| 44877B14 | 1/4 | 265X160  | 100    | 1,9 | ○    |
| 44878-14 | 1/4 | 265X160  | 65     | 1,4 | ●    |
| 44878B14 | 1/4 | 265X160  | 100    | 1,9 | ●    |



| art.     | GN  | dim. mm. | h. mm. | lt. | col. |
|----------|-----|----------|--------|-----|------|
| 44877-16 | 1/6 | 175X160  | 65     | 0,8 | ○    |
| 44877B16 | 1/6 | 175X160  | 100    | 1,0 | ○    |
| 44878-16 | 1/6 | 175X160  | 65     | 0,8 | ●    |
| 44878B16 | 1/6 | 175X160  | 100    | 1,0 | ●    |



**GN-lids, POLICARBONATE**  
GN-coperchi, POLICARBONATO  
GN-Deckel, POLIKARBONAT  
GN couvercles, POLICARBONATE  
GN tapas, POLICARBONATO

PC

| art.     | GN  | dim. mm. |
|----------|-----|----------|
| 44818-11 | 1/1 | 530X325  |
| 44818-12 | 1/2 | 325X265  |
| 44818-13 | 1/3 | 325X175  |
| 44818-14 | 1/4 | 265X160  |
| 44818-16 | 1/6 | 175X160  |



# PORCELAIN PORCELLANA

GN FOOD PANS  
CONTENITORI GN



## GN-containers

GN bacinelle  
GN-Behälter  
GN bacs  
GN cubetas

| art.     | GN  | dim. mm. | h. mm. | col. |
|----------|-----|----------|--------|------|
| 44332-03 | 1/1 | 530x325  | 20     | ○    |
| 44332-06 | 1/1 | 530x325  | 65     | ○    |
| 44382A06 | 1/1 | 530x325  | 65     | ●    |
| 44382B06 | 1/1 | 530x325  | 65     | ●    |
| 44382G06 | 1/1 | 530x325  | 65     | ●    |
| 44382O06 | 1/1 | 530x325  | 65     | ●    |
| 44382Y06 | 1/1 | 530x325  | 65     | ●    |
| 44332B06 | 1/1 | 530x325  | 65     | ●    |

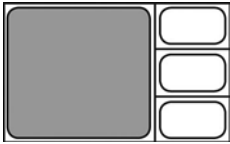

| art.     | GN  | dim. mm. | h. mm. | col. |
|----------|-----|----------|--------|------|
| 44333-03 | 2/3 | 353x320  | 20     | ○    |
| 44333-06 | 2/3 | 353x320  | 65     | ○    |
| 44333B06 | 2/3 | 353x320  | 65     | ●    |
| 44383O06 | 2/3 | 353x320  | 65     | ●    |
| 44383Y06 | 2/3 | 353x320  | 65     | ●    |

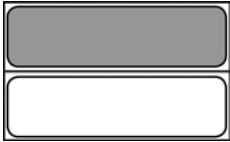

| art.     | GN  | dim. mm. | h. mm. | col. |
|----------|-----|----------|--------|------|
| 44334-03 | 2/4 | 162x530  | 20     | ○    |
| 44334-06 | 2/4 | 162x530  | 65     | ○    |
| 44384A06 | 2/4 | 162x530  | 65     | ●    |
| 44384O06 | 2/4 | 162x530  | 65     | ●    |
| 44384R06 | 2/4 | 162x530  | 65     | ●    |
| 44384Y06 | 2/4 | 162x530  | 65     | ●    |



| art.     | GN  | dim. mm. | h. mm. | col. |
|----------|-----|----------|--------|------|
| 44335-03 | 1/2 | 325x265  | 20     | ○    |
| 44335-06 | 1/2 | 325x265  | 65     | ○    |
| 44335B06 | 1/2 | 325x265  | 65     | ●    |
| 44385A06 | 1/2 | 325x265  | 65     | ●    |
| 44385B06 | 1/2 | 325x265  | 65     | ●    |
| 44385G06 | 1/2 | 325x265  | 65     | ●    |
| 44385O06 | 1/2 | 325x265  | 65     | ●    |
| 44385R06 | 1/2 | 325x265  | 65     | ●    |
| 44385Y06 | 1/2 | 325x265  | 65     | ●    |

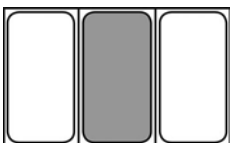

| art.     | GN  | dim. mm. | h. mm. | col. |
|----------|-----|----------|--------|------|
| 44337-03 | 1/3 | 325x175  | 20     | ○    |
| 44337-06 | 1/3 | 325x175  | 65     | ○    |
| 44337B06 | 1/3 | 325x175  | 65     | ●    |
| 44387A06 | 1/3 | 325x175  | 65     | ●    |
| 44387B06 | 1/3 | 325x175  | 65     | ●    |
| 44387G06 | 1/3 | 325x175  | 65     | ●    |
| 44387O06 | 1/3 | 325x175  | 65     | ●    |
| 44387R06 | 1/3 | 325x175  | 65     | ●    |
| 44387Y06 | 1/3 | 325x175  | 65     | ●    |



| art.     | GN  | dim. mm. | h. mm. | col. |
|----------|-----|----------|--------|------|
| 44338-03 | 1/4 | 265x160  | 20     | ○    |
| 44338-06 | 1/4 | 265x160  | 65     | ○    |



| art.     | GN  | dim. mm. | h. mm. | col. |
|----------|-----|----------|--------|------|
| 44339-03 | 1/6 | 176x160  | 20     | ○    |
| 44339-06 | 1/6 | 176x160  | 65     | ○    |



# INDUCTION PORCELAIN PORCELLANA INDUZIONE

GN FOOD PANS  
CONTENITORI GN

PR GN  INDUCTION  
READY!





**GN-containers**

GN bacinelle  
GN-Behälter  
GN bacs  
GN cubetas

| art.     | GN  | dim. mm. | h. mm. | col. |
|----------|-----|----------|--------|------|
| 44342-06 | 1/1 | 530x325  | 65     | ○    |
| 44312A06 | 1/1 | 530x325  | 65     | ●    |
| 44312B06 | 1/1 | 530x325  | 65     | ●    |
| 44312G06 | 1/1 | 530x325  | 65     | ●    |
| 44312O06 | 1/1 | 530x325  | 65     | ●    |
| 44312R06 | 1/1 | 530x325  | 65     | ●    |
| 44312Y06 | 1/1 | 530x325  | 65     | ●    |

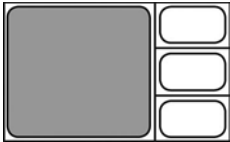

| art.     | GN  | dim. mm. | h. mm. | col. |
|----------|-----|----------|--------|------|
| 44343-06 | 2/3 | 353x320  | 65     | ○    |
| 44313B06 | 2/3 | 353x320  | 65     | ●    |
| 44313G06 | 2/3 | 353x320  | 65     | ●    |
| 44313O06 | 2/3 | 353x320  | 65     | ●    |
| 44313R06 | 2/3 | 353x320  | 65     | ●    |
| 44313Y06 | 2/3 | 353x320  | 65     | ●    |



| art.     | GN  | dim. mm. | h. mm. | col. |
|----------|-----|----------|--------|------|
| 44344-06 | 2/4 | 162x530  | 65     | ○    |
| 44314A06 | 2/4 | 162x530  | 65     | ●    |
| 44314B06 | 2/4 | 162x530  | 65     | ●    |
| 44314G06 | 2/4 | 162x530  | 65     | ●    |
| 44314O06 | 2/4 | 162x530  | 65     | ●    |
| 44314R06 | 2/4 | 162x530  | 65     | ●    |
| 44314Y06 | 2/4 | 162x530  | 65     | ●    |



| art.     | GN  | dim. mm. | h. mm. | col. |
|----------|-----|----------|--------|------|
| 44345-06 | 1/2 | 325x265  | 65     | ○    |
| 44315A06 | 1/2 | 325x265  | 65     | ●    |
| 44315B06 | 1/2 | 325x265  | 65     | ●    |
| 44315G06 | 1/2 | 325x265  | 65     | ●    |
| 44315O06 | 1/2 | 325x265  | 65     | ●    |
| 44315R06 | 1/2 | 325x265  | 65     | ●    |
| 44315Y06 | 1/2 | 325x265  | 65     | ●    |

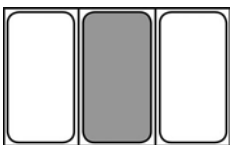

| art.     | GN  | dim. mm. | h. mm. | col. |
|----------|-----|----------|--------|------|
| 44347-06 | 1/3 | 325x175  | 65     | ○    |
| 44317A06 | 1/3 | 325x175  | 65     | ●    |
| 44317B06 | 1/3 | 325x175  | 65     | ●    |
| 44317G06 | 1/3 | 325x175  | 65     | ●    |
| 44317O06 | 1/3 | 325x175  | 65     | ●    |
| 44317R06 | 1/3 | 325x175  | 65     | ●    |
| 44317Y06 | 1/3 | 325x175  | 65     | ●    |



| art.     | GN  | dim. mm. | h. mm. | col. |
|----------|-----|----------|--------|------|
| 44346-06 | 1/4 | 265x160  | 65     | ○    |



# SERIES 12900

KITCHEN UTENSILS  
UTENSILI DA CUCINA

PA+  
plus



A wide range of professional kitchen utensils in composite material, polyamide (nylon 6.6) with fiberglass. Dishwasher safe, can be sterilized, heat resistant up to 220°C. Safe for non-stick cookware.

Un'ampia gamma di utensili professionali per la cucina in materiale composito, poliammide (nylon 6.6) con fibra di vetro. Lavabili in lavastoviglie, sterilizzabili, resistenti fino a 220°C. Ideali per l'uso con antiaderenti.





**PA+**  
plus

**Spoon**  
Cucchiaione  
Löffel  
Mouvette  
Cuchara

| art.     | l. cm. |
|----------|--------|
| 12903-30 | 30     |
| 12903-40 | 38     |
| 12903-45 | 45     |



**PA+**  
plus

**Spatula**  
Spatola  
Teigschäber  
Spatule  
Espátula

| art.     | l. cm. |
|----------|--------|
| 12905-25 | 25     |
| 12905-30 | 30     |
| 12905-35 | 35     |
| 12905-40 | 40     |
| 12905-45 | 45     |
| 12905-50 | 50     |



**PA+**  
plus

**Stirring ladle**  
Spatola per stemperare  
Rühr-u. Temperierlöffel  
Spatule à délayer  
Espátula para diluir

| art.     | l. cm. |
|----------|--------|
| 12907-07 | 35     |
| 12907-08 | 35     |



**PA+**  
plus

**Spatula**  
Spatola  
Stielschäber  
Spatule  
Espátula

| art.     | l. cm. |
|----------|--------|
| 12915-25 | 25     |
| 12915-26 | 28     |
| 12915-35 | 35     |
| 12915-45 | 45     |



**PA+**  
plus

**Spatula**  
Spatola  
Teigschäber  
Spatule  
Espátula

| art.     | l. cm. |
|----------|--------|
| 12916-25 | 25     |
| 12916-33 | 33     |



**PA+**  
plus

**Spatula**  
Spatola triangolare  
Dreieck-Stielschäber  
Spatule trilon  
Espátula triangular

| art.     | l. cm. |
|----------|--------|
| 12917-25 | 25     |



**PA+**  
plus

**Bevelled spatula**  
Spatola smussata  
Teigschäber  
Spatule plate biseauté  
Espátula blanda

| art.     | l. cm. |
|----------|--------|
| 12906-35 | 35     |



**PA+**  
plus

**Spatula**  
Spatola  
Teigschäber  
Spatule  
Espátula

| art.     | l. cm. |
|----------|--------|
| 12908-30 | 30     |
| 12908-35 | 35     |
| 12908-40 | 40     |



**PA+**  
plus

**Angular spatula**  
Paletta angolare  
Winkelpalette  
Spatule angulaire  
Espátula

| art.     | l. cm. |
|----------|--------|
| 12909-12 | 12     |
| 12909-23 | 23     |



**PA+**  
plus

**Spatula, perforated**  
Paletta forata  
Teigschäber, perforiert  
Spatule ajourée  
Espátula perforada

| art.     | l. cm. |
|----------|--------|
| 12921-01 | 30     |



**PA+**  
plus

**Spatula, perforated**  
Paletta forata  
Teigschäber, perforiert  
Spatule ajourée  
Espátula perforada

| art.     | l. cm. |
|----------|--------|
| 12921-05 | 30     |



**PA+**  
plus

**Spatula**  
Paletta  
Teigschäber  
Spatule  
Espátula

| art.     | l. cm. |
|----------|--------|
| 12921-10 | 32     |



**PA+**  
*plus*

**Fish & chips spatula**

Paletta fritti  
Fischheber  
Pelle à friture  
Espátula fritura

| art.     | l. cm. |
|----------|--------|
| 12921-15 | 35     |



**PA+**  
*plus*

**Ladle**

Mestolo  
Schöpfplößel  
Louche  
Cacillo

| art.     | Ø cm. | l. cm. |
|----------|-------|--------|
| 12920-01 | 9     | 31     |



**PA+**  
*plus*

**Skimmer**

Schiumarola  
Schaumlöffel  
Ecumoire  
Espumadera

| art.     | Ø cm. | l. cm. |
|----------|-------|--------|
| 12920-05 | 11    | 35     |



**PA+**  
*plus*

**Spatula**

Paletta  
Teigschäber  
Spatule  
Espátula

| art.     | cm.  | l. cm. |
|----------|------|--------|
| 12920-10 | 9x10 | 35     |



**PA+**  
*plus*

**Fish & chips spatula**

Paletta fritti  
Fischheber  
Pelle à friture  
Espátula fritura

| art.     | cm.  | l. cm. |
|----------|------|--------|
| 12920-11 | 9x10 | 35     |



**PA+**  
*plus*

**Spoon**

Cucchiaione  
Giesslöffel  
Cuillère  
Cucharón

| art.     | l. cm. |
|----------|--------|
| 12920-15 | 35     |



**PA+**  
*plus*

**Perforated spoon**

Cucchiaione forato  
Giesslöffel, perforiert  
Cuillère perforée  
Cucharón perforado

| art.     | l. cm. |
|----------|--------|
| 12920-16 | 35     |



**PA+**  
*plus*

**Salad tong**

Molla insalata  
Salatzange  
Pince à salade  
Pinza ensalada

| art.     | l. cm. |
|----------|--------|
| 12930-51 | 25     |
| 12930-52 | 32     |



**PA+**  
*plus*

**Bread and pastry tong**

Molla per pane e pasticceria  
Brot-/Gebäckzange  
Pince à pain et pâtisserie  
Pinza para pan y pasteleria

| art.     | l. cm. |
|----------|--------|
| 12930-62 | 18     |
| 12930-63 | 23     |



**PA+**  
*plus*

**Serving tong**

Molla tutto servire  
Servierzange  
Pince à servir  
Pinza servir

| art.     | l. cm. |
|----------|--------|
| 12930-68 | 20     |
| 12930-69 | 25     |



**PA+**  
*plus*

**Spaghetti tong**

Molla spaghetti  
Spaghettizange  
Pince à spaghetti  
Pinza espagueti

| art.     | l. cm. |
|----------|--------|
| 12930-74 | 24     |



**PA+**  
*plus*

**Toast and pastry tong**

Molla per toast e dolci  
Toast-/Gebäckzange  
Pince à toast et tarte  
Pinza para tostadas y dulces

| art.     | l. cm. |
|----------|--------|
| 12930-77 | 21     |
| 12930-78 | 25     |



PA+  
plus

**Meat ball plier**  
Forbice per polpette  
Fleischkugelzange  
Pince à boulettes  
Pinza albóndigas

| art.     | l. cm. |
|----------|--------|
| 12931-51 | 17     |



PA+  
plus

**Quenelle plier**  
Forbice per chenelle  
Quenellezange  
Pince à quenelles  
Pinza quenelles

| art.     | l. cm. |
|----------|--------|
| 12931-53 | 19     |



PA+  
plus

**Perforated ladle**  
Mestolo forato  
Schöpföffel, gelocht  
Louche perforée  
Cacillo perforado

| art.     | Ø cm. | l. cm. |
|----------|-------|--------|
| 12967-06 | 6,5   | 30     |
| 12967-10 | 10,0  | 37,5   |



PA+  
plus

**Ladle**  
Mestolo  
Schöpföffel  
Louche  
Cacillo

| art.      | Ø cm. | l. cm. |
|-----------|-------|--------|
| 12970-06* | 6,5   | 30,0   |
| 12970-08  | 8,0   | 33,5   |
| 12970-10  | 10,0  | 37,5   |
| 12970-12  | 12,0  | 40,0   |

\*With spout. – Con becco.



PA+  
plus

**Pizza ladle, flat bottom**  
Mestolo pizza, fondo piatto  
Schöpföffel  
Louche  
Cacillo

| art.     | Ø cm. | l. cm. |
|----------|-------|--------|
| 12968-10 | 10    | 27     |



PA+  
plus

**Ladle, short handle**  
Mestolo, manico corto  
Schöpföffel mit kurzen Stiel  
Louche, manche court  
Cacillo, mango corto

| art.     | Ø cm. | l. cm. |
|----------|-------|--------|
| 12969-10 | 10    | 27     |



PA+  
plus

**Ladle, short handle**  
Mestolo, manico corto  
Schöpföffel mit kurzen Stiel  
Louche, manche court  
Cacillo, mango corto

| art.     | Ø cm. | l. cm. |
|----------|-------|--------|
| 12969-06 | 6,5   | 24     |



PA+  
plus

**Spoon**  
Cucchiaione  
Löffel  
Cuillère  
Cuchara

| art.     | l. cm. |
|----------|--------|
| 12986-38 | 37,5   |



PA+  
plus

**Spoon, short handle**  
Cucchiaione, manico corto  
Löffel mit kurzen Stiel  
Cuillère, manche court  
Cuchara, mango corto

| art.     | l. cm. |
|----------|--------|
| 12986-01 | 23     |



PA+  
plus

**Skimmer**  
Schiumarola  
Schaumlöffel  
Ecumoire  
Espumadera

| art.     | Ø cm. | l. cm. |
|----------|-------|--------|
| 12971-10 | 10    | 31     |
| 12971-12 | 12    | 37     |



PA+  
plus

**Spatula**  
Paletta liscia  
Backschaufel  
Spatule  
Espátula lisa

| art.     | cm. | l. cm. |
|----------|-----|--------|
| 12972-10 | 10  | 36,5   |
| 12972-12 | 12  | 38,0   |



PA+  
plus

**Perforated spatula**  
Paletta forata  
Backschaufel, perforiert  
Spatule perforée  
Espátula perforada

| art.     | cm. | l. cm. |
|----------|-----|--------|
| 12973-10 | 10  | 36,5   |
| 12973-12 | 12  | 38     |



**PA+**  
plus

**Conical colander**

Colatutto tronco conico  
Gemüsesieher  
Passoire à légumes  
Colador cónico

| art.     | Ø cm. | h. | lt. |
|----------|-------|----|-----|
| 12950-32 | 32    | 16 | 8   |
| 12950-40 | 40    | 20 | 12  |



**SS**  
**PA+**  
plus

**Strainer**

Colatutto  
Sieb  
Passoire  
Colador multiuso

| art.     | cm.     | l. cm. |
|----------|---------|--------|
| 12932-22 | 22x18,5 | 44     |
| 12932-26 | 26x21   | 47     |



**SS**  
**PA+**  
plus

**Soup strainer**

Colino a rete  
Suppensieb  
Passe-bouillon  
Colador a red

| art.     | Ø cm. | l. cm. |
|----------|-------|--------|
| 12941-07 | 7     | 12     |
| 12941-10 | 10    | 12     |
| 12941-12 | 12    | 17     |
| 12941-14 | 14    | 17     |
| 12941-16 | 16    | 17     |
| 12941-18 | 18    | 17     |
| 12941-20 | 20    | 17     |
| 12941-23 | 23    | 27     |
| 12941-26 | 26    | 27     |



**SS**  
**PA+**  
plus

**Wire whip, 8 silicone wires**

Frusta, 8 fili silicone  
Rührbesen, 8 Drähte aus Silikon  
Fouet, 8 fils en silicone  
Batidor, 8 varillas de siliconea

| art.     | l. cm. |
|----------|--------|
| 12926-35 | 35     |



**SS**  
**PA+**  
plus

**Wire whip, 8 wires**

Frusta, 8 fili  
Rührbesen, 8 Drähte  
Fouet, 8 fils  
Batidor, 8 varillas

| art.     | l. cm. |
|----------|--------|
| 12928-25 | 25     |
| 12928-30 | 30     |
| 12928-35 | 35     |
| 12928-40 | 40     |
| 12928-45 | 45     |
| 12928-50 | 50     |
| 12928-55 | 55     |
| 12928-60 | 60     |



**SS**  
**PA+**  
plus

**Egg whisk, 11 wires**

Frusta media, 11 fili  
Schneebeesen, 11 Drähte  
Fouet, 11 fils  
Batidor, 11 varillas

| art.     | l. cm. |
|----------|--------|
| 12929-25 | 25     |
| 12929-30 | 30     |
| 12929-35 | 35     |
| 12929-40 | 40     |
| 12929-45 | 45     |

**Water-tight, dishwasher safe.**

Perfetta tenuta stagna, lavabile in lavastoviglie.



**SS**  
**PA+**  
plus

**Balloon whisk**

Frusta balloon  
Schneebeesen  
Fouet à blancs  
Batidor tipo globo

| art.     | l. cm. |
|----------|--------|
| 12927-35 | 35     |
| 12927-45 | 45     |

**Water-tight, dishwasher safe.**

Perfetta tenuta stagna, lavabile in lavastoviglie.

# SERIES 48280 - 48278

KITCHEN UTENSILS  
UTENSILI DA CUCINA



**A wide range of professional kitchen utensils. These are essential tools to make original decorations as well as to ease the preparation of your recipes. All items are made of 18/10 stainless steel while their ergonomic handles are available both in stainless steel and Polypropylene. They are all hangable and can be cleaned in dishwasher. They boast a modern, functional design and are very easy to use.**

Un'ampia gamma di utensili professionali per la cucina, indispensabili per creare decorazioni originali e fantasiose, ma utili anche per svolgere le più semplici operazioni in modo preciso e veloce. Tutti i pezzi sono realizzati in acciaio inox 18/10, mentre la manufattura ergonomica è prevista nella versione acciaio inox o polipropilene. Tutti gli articoli sono dotati di un foro sul manico per essere appesi. Lavabili in lavastoviglie. Il design è moderno e funzionale per il massimo comfort d'utilizzo.



**Pizza knife**

Coltello per pizza  
Pizza-Messer  
Couteau à pizza  
Cuchillo pizza

| art.     | l. cm. |
|----------|--------|
| 48280-45 | 23,5   |



**Pizza wheel**

Rotella taglia pizza  
Pizza-Rad  
Roulette à pizza  
Ruleta cortapizzas

| art.     | Ø cm. | l. cm. |
|----------|-------|--------|
| 18324-10 | 10    | 24     |



**Pastry wheel**

Rotella taglia pasta  
Teig-Rad  
Roulette à pâte  
Ruleta cortapasta

| art.     | Ø cm. | l. cm. |
|----------|-------|--------|
| 48280-32 | 4     | 18     |



**Double pastry wheel**

Rotella taglia pasta doppia  
Teig-Rad, doppel  
Roulette a pâte double  
Ruleta cortapasta doble

| art.     | Ø cm. | l. cm. |
|----------|-------|--------|
| 48280-39 | 4     | 18     |



**Vegetables knife**

Coltello verdure  
Gemüsemesser  
Couteau à crudités  
Cuchillo verduras

| art.     | l. cm. |
|----------|--------|
| 48280-48 | 19     |



**Parsley knife**

Falchetta prezzemolo  
Petersilie-Wiegemesser  
Hachinette persil  
Cuchillo perejil

| art.     | Ø cm. | l. cm. |
|----------|-------|--------|
| 48280-20 | 11    | 17     |



**Cheese knife**

Coltello grana  
Käsemesser  
Couteau à fromage  
Cuchillo queso

| art.     | l. cm. |
|----------|--------|
| 48280-04 | 20     |



**Oyster knife**

Coltello apriostriche/cozze  
Austernmesser  
Couteau à huîtres  
Cuchillo ostras

| art.     | l. cm. |
|----------|--------|
| 48280-05 | 20,5   |



**Chestnut knife**

Coltello castagne  
Kastanienmesser  
Couteau à marrons  
Cuchillo castañas

| art.     | l. cm. |
|----------|--------|
| 48280-21 | 16     |



**Fish scaler**

Squamapesce  
Fischentschupper  
Ecailleur à poisson  
Escamador

| art.     | l. cm. |
|----------|--------|
| 48280-38 | 23,5   |



**Double fish scaler**  
Squamapesce doppio  
Fischentschupper, doppel  
Ecailleur à poisson double  
Escamador doble

art. cm.  
48280-37 22,5x3,5



**Cheese slicer**  
Affettaformaggio  
Käsemesser  
Couteau à fromage  
Cuchillo para cortar queso

art. cm.  
48280-41 25x7,6



**Cheese cleaver**  
Mannaietta per formaggio  
Käsemesser  
Couteau à fromage  
Hacha para queso

art. cm.  
48280-49 21x4



**Cheese knife**  
Coltello formaggio  
Käsemesser  
Couteau à fromage  
Cuchillo para queso

art. l. cm.  
48280-59 27



**Parmesan knife**  
Coltello grana  
Käsemesser  
Couteau à fromage  
Cuchillo para queso parmesano

art. l. cm.  
48280-46 24



**Butter spreader**  
Spalmaburro  
Butterstreicher  
Couteau à tartiner  
Cuchillo para untar

art. l. cm.  
48280-75 21,5



**Pie pan knife**  
Coltello tortiera  
Tortenring-Messer  
Couteau à manqué  
Cuchillo para tartas

art. l. cm.  
48280-22 21



**Vegetable sharpener**  
Temperino per verdure  
Gemüsefedermesser  
Taille crayon légumes  
Afilador para vegetales

art. Ø cm.  
48280-12 4,5  
48280-13 7,0



**Pastry brush, silicone**  
Pennello silicone  
Kuchenpinsel, Silikon  
Pinceau, silicone  
Pincel pastelería, silicona

art. cm.  
48280-09 25,5x4



**Pastry brush**  
Pennello  
Kuchenpinsel  
Pinceau  
Pincel pastelería

art. cm.  
48280-94 22,5x3,5



**Ceddar/cheese grater**  
Grattugia formaggio  
Käsereibe  
Râpe à fromage  
Rallador queso

art. l. cm.  
48280-06 24



**Bottle opener**  
Apribottiglie  
Flaschenöffner  
Décapsuleur  
Abrebotellas

art. l. cm.  
48280-02 19



**Can opener**  
Apriscatole  
Dosenöffner  
Ouvre boîtes  
Abrelatas

art. cm.  
48280-03 22x4,6



**Melon baller**  
Scavino  
Kugelausstecher  
Cuillère parisienne  
Cortador bolas

| art.     | Ø cm. | l. cm. |
|----------|-------|--------|
| 48280-24 | 1,0   | 19,0   |
| 48280-30 | 1,5   | 19,0   |
| 48280-31 | 2,0   | 19,0   |
| 48280-35 | 2,3   | 19,5   |
| 48280-36 | 3,0   | 19,5   |



**Double melon baller**  
Scavino doppio  
Kugelausstecher, doppel  
Cuillère parisienne, double  
Cortador bolas, doble

art. Ø cm. l. cm.  
48286-67 2,2-3,0 17



**Oval melon baller**  
Scavino ovale  
Kugelausstecher, oval  
Moule à pommes, ovale  
Cortador oval

art. Ø cm. l. cm.  
48280-26 1,9 19,5



**Zucchini corer, dented**  
Scavazucchine, seghettato  
Gemüseausstecher  
Vide-courgettes  
Vaciador de zucchini

art. l. cm.  
48280-54 24,5



**Pineapple coring tool**  
Svuota ananas  
Ananasausstecher  
Vide ananas  
Vacía corazón piña

art. l. cm.  
48280-10 25





**Asparagus peeler**  
Pelasparagi  
Spargelschäler  
Eplucheur à asperges  
Pelador de espárrago

art. l. cm.  
48280-85 23,5



**Tomato peeler**  
Pelapomodori  
Tomatenschäler  
Eplucheur à tomates  
Pelador de tomates

art. l. cm.  
48280-08 18



**Y-shaped swivel peeler**  
Sbucciatore a Y  
Pendelschäler  
Eplucheur  
Pelador forma Y

art. l. cm.  
48280-53 18,5  
48280-52 21,0



**Melon peeler**  
Sbuccia melone  
Melonenschäler  
Eplucheur à melon  
Pelador de melon

art. Ø cm. l. cm.  
48280-60 8,0 20  
48280-61 9,0 21  
48280-62 10,5 22  
48280-63 12,0 23



**Potato peeler**  
Pelapatate  
Sparschäler  
Eplucheur  
Pelador de patatas

art. l. cm.  
48280-34 19,5



**Orange peeler**  
Pelarance  
Orangenschäler  
Eplucheur à oranges  
Pelador de naranjas

art. l. cm.  
48280-96 20



**Grapefruit knife**  
Coltello per pompelmo  
Grapefruitmesser  
Couteau à pamplemousse  
Cuchillo para pomelo

art. l. cm.  
48280-47 21,5



**Citrus knife**  
Coltello agrumi  
Zitrus-Messer  
Couteau à agrumes  
Cuchillo para cítricos

art. l. cm.  
48280-97 23



**Fruit scoop**  
Porzionatore macedonia  
Fruchtportionierer  
Cuiller à fruits  
Raciondor de ensalada de frutas

art. l. cm.  
48280-15 20



**Butter curler**  
Arricciaburro  
Butter Lockenwickler  
Coquilleur à beurre  
Rizador de mantequilla

art. l. cm.  
48280-11 22,5



**Fruit decorating knife**

Coltello decora frutta  
Dekoriermesser  
Denteleur  
Cuchillo para decorar fruta

art. l. cm.  
48280-91 23



**Decorator**

Decoratore  
Ziseliermesser  
Canneleur  
Decorador

art. l. cm.  
48280-95 16,5



**Lemon striper**

Decora limoni  
Zesteur  
Canneleur  
Decorador de limones

art. l. cm.  
48280-92 17



**Lemon striper**

Rigalimoni  
Zesteur  
Canneleur  
Acanalar de limones

art. l. cm.  
48280-90 17



**Apple corer**

Levatorsoli  
Entkerner  
Vide-pommes  
Descorazonador

art. Ø cm. l. cm.  
48280-25 1,2 21



**Vegetable cutter**

Tagliaverdure ondulato  
Wellenschneider  
Découpoir à lame ondulée  
Cortador de verduras ondulado

art. l. cm.  
48280-23 11,5

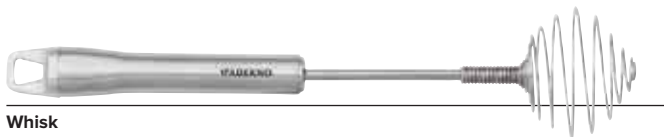

**Whisk**

Frusta  
Rührbesen  
Fouet  
Batidor

art. Ø cm. l. cm.  
48278-24 5 26,5



**Pizza wheel**

Rotella taglia pizza  
Pizza-Rad  
Roulette à pizza  
Ruleta cortapizzas

art. Ø cm. l. cm.  
48278-33 7 21



**Pastry wheel**

Rotella taglia pasta  
Teig-Rad  
Roulette à pâte  
Ruleta cortapasta

art. Ø cm. l. cm.  
48278-32 4 18



**Double pastry wheel**

Rotella taglia pasta doppia  
Teig-Rad, doppel  
Roulette a pâte double  
Ruleta cortapasta doble

art. Ø cm. l. cm.  
48278-39 4 18



**Fish scaler**

Squamapesce  
Fischentschupper  
Ecailleur à poisson  
Escamador

| art.     | l. cm. |
|----------|--------|
| 48278-38 | 22     |



**Paring knife**

Spelucchino  
Spickmesser  
Couteau d'office  
Cuchillo moldeador

| art.     | l. cm. |
|----------|--------|
| 48278-55 | 22,5   |



**Conical colander**

Colino conico  
Suppensieb  
Passe-bouillon  
Colador cónico

| art.     | Ø cm. | l. cm. |
|----------|-------|--------|
| 48278-13 | 16    | 35     |



**Soup strainer**

Colino  
Suppensieb  
Passe-bouillon  
Colador

| art.     | Ø cm. | l. cm. |
|----------|-------|--------|
| 48278-12 | 8     | 27     |



**Vegetables knife**

Coltello verdure  
Gemüsemesser  
Couteau à crudités  
Cuchillo de verduras

| art.     | l. cm. |
|----------|--------|
| 48278-48 | 19     |



**Cheese slicer**

Affettaformaggio tenero  
Käsemesser  
Couteau à fromage  
Cortador de queso suave

| art.     | cm.    |
|----------|--------|
| 48278-42 | 20x7,5 |



**Cheese cleaver**

Mannaietta per formaggio  
Käsemesser  
Coutau à fromage  
Hachita para queso

| art.     | cm.  |
|----------|------|
| 48278-49 | 21x4 |



**Cheese knife**

Coltello parmigiano  
Käsemesser  
Coutau à fromage  
Cuchillo para queso

| art.     | l. cm. |
|----------|--------|
| 48278-46 | 23,5   |



**Cheese slicer**

Affettaformaggio  
Käsereibe  
Couteau à fromage  
Cortador de queso

| art.     | l. cm. |
|----------|--------|
| 48278-41 | 25     |



**Potato masher**

Pressapatate  
Kartoffelpresse  
Presse-purée  
Prensador de patatas

| art.     | cm. | l. cm. |
|----------|-----|--------|
| 48278-87 | 8x7 | 27     |



**Potato masher**  
Pressapatate  
Kartoffelpresse  
Presse-purée  
Prensador de patatas

art. cm.  
48278-31 27x8



**Butter spreader**  
Spalmaburro  
Buttermesser  
Couteau à beurre  
Cuchillo mantequilla

art. l. cm.  
48278-75 21



**Grater**  
Grattugia  
Reibe  
Râpe  
Rallador

art. cm.  
48278-20 25,5x5,5



**Grater**  
Grattugia  
Reibe  
Râpe  
Rallador

art. cm.  
48278-21 25,5x5,5



**Oyster/cheese knife**  
Coltello apriostriche/grana  
Austern-/Käsemesser  
Couteau à huîtres/fromage  
Cuchillo para ostras/queso

art. l. cm.  
48278-45 20



**Spatula**  
Spatola per glassa  
Palette  
Spatule  
Espátula

art. l. cm.  
48278-77 27,5



**Pastry brush**  
Pennello pasticceria  
Kuchenpinsel  
Pinceau à cuisine  
Pincel pastelería

art. l. cm.  
48278-94 22



**Garlic press**  
Spremiaglio  
Knoblauchpresse  
Presse-ail  
Prensador de ajo

art. cm.  
48278-37 19x5

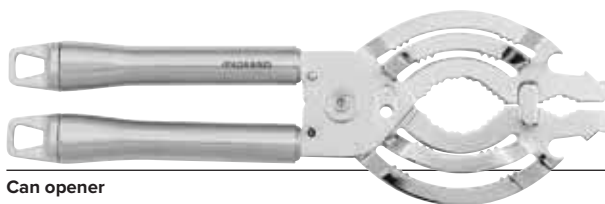

**Can opener**  
Apribarattoli  
Deckelöffner  
Ouvre-boîtes  
Abrelatas

art. cm.  
48278-01 25,5x8,5



**Bottle opener**  
Apribottiglie  
Flaschenöffner  
Ouvre-bouteilles  
Abrebotellas

art. cm.  
48278-02 19x3,7



**Can opener**

Apriscatole  
Dosenöffner  
Ouvre-boîtes  
Abrelatas

art. cm.  
48278-03 22x4,6



**Zucchini corer, dented**

Scavazucchine, seghettato  
Gemüseausstecher  
Vide-courgettes  
Vaciador de zucchini, dentado

art. l. cm.  
48278-54 25



**Potato peeler**

Pelapatate  
Kartoffelschäler  
Eplucheur  
Pelador de patatas

art. l. cm.  
48278-34 19,5



**Swivel peeler**

Sbucciatore a lama mobile  
Pendelschäler  
Eplucheur  
Pelador a cuchilla mobile

art. l. cm.  
48278-52 21



**Melon baller**

Scavino sferico  
Kugelausstecher  
Moule à pommes  
Vaciador

art. Ø cm. l. cm.  
48278-35 3 18



**Y-shaped swivel peeler**

Sbucciatore a Y  
Pendelschäler  
Eplucheur  
Pelador forma Y

art. l. cm.  
48278-53 18,5



**Orange peeler**

Pelarance  
Orangenschäler  
Eplucheur à pamplemousse  
Pelador de naranja

art. l. cm.  
48278-96 20



**Apple corer**

Levatoroli  
Entkerner  
Vide-pomme  
Descorazonador

art. Ø cm. l. cm.  
48278-25 1,6 21,5



**Grapefruit knife**

Coltello per pompelmo  
Orangenschäler  
Couteau à pamplemousse  
Cuchillo para pomelo

art. l. cm.  
48278-47 21,5



**Potato fork**

Forchettina 3 punte  
Gabelchän  
Petite fourchette  
Tenedor tre puntas

art. l. cm.  
48278-17 16,5



**Ice cream scoop**

Porzionatore gelato  
Eisportionierer  
Cuillère à glace  
Racionador de helado

art. Ø cm. l. cm.  
48278-95 4 21



**Coffee measuring spoon**

Dosa caffè  
Maßlöffel  
Cuillère à mesure  
Porcionador de café

art. Ø cm. l. cm.  
48278-16 3,5 20



**Egg separator**

Separauova  
Eier-Trenner  
Sépare oeufs  
Separador de huevos

art. Ø cm. l. cm.  
48278-36 5,5 20,5



**Decorating knife**

Coltello decora frutta  
Dekoriermesser  
Couteau à décorer  
Cuchillo para decorar frutas

art. l. cm.  
48278-91 22,5



**Cocktail spoon**

Cucchiaio cocktail  
Cocktaillöffel  
Cuiller à cocktail  
Cuchara cóctel

art. Ø cm. l. cm.  
48278-15 6 28



**Lemon striper**

Decora limoni  
Zesteur  
Canneleur  
Decorador de limones

art. l. cm.  
48278-92 16,5



**Butter curler**

Arricciaburro  
Buttermesser  
Couteau à beurre  
Ruzador de mantequilla

art. l. cm.  
48278-11 21,5



**Smell-remover soap**

Saponetta togli odori  
Geruchentferner-Seife  
Savonette enlève odeurs  
Jabon quita odores

art. cm.  
48278-99 7,5x5,5



**Sauce ladle**

Mestolino salsa  
Saucenlöffel  
Louche à sauce  
Cacillo salsa

art. Ø cm. l. cm.  
48278-68 7 29



**Ladle**

Mestolo  
Schöpflöffel  
Louche  
Cazo

art. Ø cm. l. cm.  
48278-69 9 32  
48278-66 6 29



**Salad fork**

Forchetta insalata  
Saltgabel  
Fourchette à salade  
Tenedor para ensaladas

art. Ø cm. l. cm.  
48278-64 5 25,5



**Salad spoon**  
Cucchiaio insalata  
Salatlöffel  
Cuiller à salade  
Cuchara para ensaladas

| art.     | Ø cm. | l. cm. |
|----------|-------|--------|
| 48278-62 | 5     | 25     |



**Perforated spoon**  
Cucchiaio forato  
Giesslöffel, perforiert  
Cuiller perforé  
Cuchara perforada

| art.     | cm.  |
|----------|------|
| 48278-61 | 34x6 |

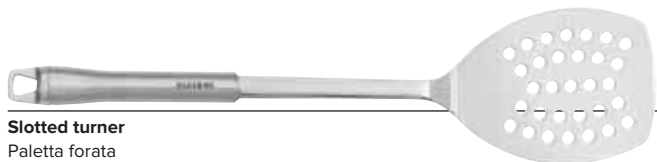

**Slotted turner**  
Paletta forata  
Küchenwender  
Pelle ajourée  
Espátula perforada

| art.     | cm.      |
|----------|----------|
| 48278-71 | 34,5x8,5 |



**Skimmer**  
Schiumarola  
Drahtlöffel  
Ecumoir  
Espumadera

| art.     | Ø cm. | l. cm. |
|----------|-------|--------|
| 48278-73 | 11    | 37     |

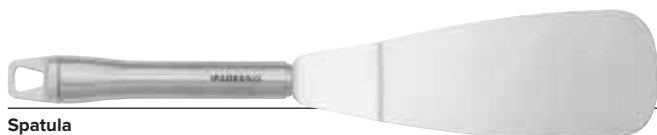

**Spatula**  
Spatola  
Palette  
Spatule  
Espátula

| art.     | cm.      |
|----------|----------|
| 48278-76 | 28,5x5,6 |



**Pie server**  
Pala torta  
Tortenheber  
Pelle à gâteau  
Paleta para tartas

| art.     | cm.    |
|----------|--------|
| 48278-93 | 26x5,8 |



**Spaghetti server**  
Servispaghetti  
Spaghettlöffel  
Cuiller à spaghetti  
Servidor para espagueti

| art.     | Ø cm. | l. cm. |
|----------|-------|--------|
| 48278-74 | 7     | 30,5   |



**Fork**  
Forchettone  
Gabel  
Fourchette  
Tenedor

| art.     | l. cm. |
|----------|--------|
| 48278-65 | 32,5   |



**Rice spoon**  
Cucchiaio risotto  
Reislöffel  
Rice spoon  
Cuchara para risotto

| art.     | l. cm. |
|----------|--------|
| 48278-63 | 27     |



**Lasagne spatula**  
Pala pasticcio  
Palette  
Pelle  
Pala para pastel

| art.     | cm.    |
|----------|--------|
| 48278-27 | 29x4,5 |



**Skimmer**  
Schiumarola  
Drahtlöffel  
Ecumoir  
Espumadera

| art.     | Ø cm. | l. cm. |
|----------|-------|--------|
| 48278-88 | 11    | 36,5   |



**Ladle**  
Mestolo  
Schöpflöffel  
Louche  
Cazo

| art.     | Ø cm. | l. cm. |
|----------|-------|--------|
| 48278-84 | 9,5   | 32,5   |



**Rice spoon**  
Cucchiaio riso  
Giesslöffel  
Cuiller  
Cuchara

| art.     | cm.    |
|----------|--------|
| 48278-82 | 33x6,5 |



**Perforated spoon**  
Cucchiaio forato  
Giesslöffel, perforiert  
Cuiller ajouré  
Cuchara perforada

| art.     | cm.    |
|----------|--------|
| 48278-81 | 33x6,5 |



**Spaghetti server**  
Servispaghetti  
Spaghettillöffel  
Cuiller à spaghetti  
Servidor para espagueti

| art.     | cm.    |
|----------|--------|
| 48278-89 | 32x6,5 |



**Meat fork**  
Forchettone  
Gabel  
Fourchette  
Tenedor

| art.     | l. cm. |
|----------|--------|
| 48278-83 | 32,5   |



**Silicone spoon**  
Cucchiaio silicone  
Löffel aus Silikon  
Cuiller en silicone  
Cucharón de silicona

| art.     | cm.   | l. cm. |
|----------|-------|--------|
| 48278-14 | 5,5x8 | 26,5   |



**Perforated turner**  
Paletta forata  
Küchenwender, perforiert  
Pelle ajourée  
Pala perforada

| art.     | cm.    |
|----------|--------|
| 48278-85 | 33x8,5 |



**Silicone turner**  
Paletta silicone  
Palette aus Silikon  
Pelle en silicone  
Paleta de silicona

| art.     | cm. | l. cm. |
|----------|-----|--------|
| 48278-28 | 5x9 | 28,5   |

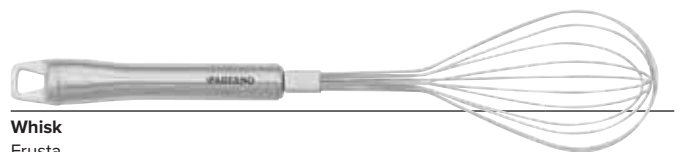

**Whisk**  
Frusta  
Rührbesen  
Fouet  
Batidor

| art.     | l. cm. |
|----------|--------|
| 48278-18 | 24,5   |
| 48278-19 | 29,5   |



# TURNERS SPATOLE

KITCHEN UTENSILS  
UTENSILI DA CUCINA

SS PP



Stainless steel turners with polypropylene handle.

Spatole in acciaio inox con manico in polipropilene.



#### Perforated spatula

Paletta forata  
Kuchenpalette, geschlitzt  
Palette perforée  
Paleta perforada

art. cm.  
18510-07 13,5x7



#### Perforated spatula

Spatola forata  
Kuchenpalette, geschlitzt  
Palette perforée  
Paleta perforada

art. cm.  
18509-01 16x7,5  
18509-02 15,6x5



#### Perforated spatula, flexible

Paletta forata, flessibile  
Palette, geschlitzt, flexibel  
Palette perforée, flexible  
Paleta perforada, flexible

art. cm.  
18509-03 15,6x8,7



**Pizza turner**

Spatola per pasticcio e pizza  
Pizzawender  
Palette à pizza  
Espátula pizza

art. cm.  
18511-15 15,5x8,7



**Hamburger turner**

Spatola hamburger  
Hamburgerspachtel  
Palette à hamburger  
Espátula hamburger

art. cm.  
18512-15 19x13,8



**Lasagne spatula**

Spatola lasagne  
Lasagneheber  
Palette à lasagne  
Espátula lasagna

art. cm.  
18515-16 16,8x7,2



**Cleaning spatula**

Spatola triangolare  
Bratenspachtel  
Spatule  
Espátula triangular

art. cm.  
18520-04 12x4  
18520-06 12x6  
18520-08 12x8  
18520-10 12x10  
18520-12 12x12



**Hamburger turner**

Spatola hamburger  
Bratenwender  
Grand palette  
Espátula hamburger

art. cm.  
18516-24 24x7,2



**Perforated hamburger turner**

Spatola hamburger, forata  
Bratenspachtel, gelocht,  
Grand palette perforée  
Espátula hamburger, perforada

art. cm.  
18517-24 24x7,2



**Angular spatula**

Spatola cuoco con scalino  
Confiseriepalette  
Palette coudée  
Espátula chef angular

art. cm.  
18518-22 22x3,4  
18518-26 25x3,7  
18518-30 30x4,3



**Spatula**

Spatola cuoco  
Palette  
Palette  
Espátula chef

art. cm.  
18519-15 15,5x3  
18519-22 22x3,4  
18519-26 26x3,7  
18519-30 31x4,3  
18519-35 36x5



**Pastry spatula**

Paletta dolci  
Gebäckpalette  
Palette à gâteau  
Pala pasteles

art. cm.  
18513-14 14,5x6,5



**Pastry spatula**

Spatola dolce  
Kuchenpalette  
Palette à pâtissier  
Espátula dulces

art. cm.  
18514-17 16,3x5,8



**Pie knife**

Coltello torta  
Tortenmesser  
Couteau à gâteau  
Cuchillo pasteles

art. cm.  
18514-18 17,3x5,8



**Farinata knife**

Coltello per farinata  
Farinata Messer  
Couteau à farinata  
Cuchillo farinata

art. l. cm.  
42830-08 8

# LADLES MESTOLI

KITCHEN UTENSILS  
UTENSILI DA CUCINA



**The PADERNO ladle.**  
Handle-cup connection (one piece ladle). Thicker handle with rounded border.  
Diameter and capacity stamped on the handle.

**Il mestolo PADERNO.**  
Accoppiamento manico-coppa (mestolo unipezzo). Manico con spessore maggiorato  
con bordi arrotondati. Indicazione sul manico del diametro e della capacità.



NSF  
SS

**One piece ladle**

Mestolo unipezzo  
Schöpflöffel, fugenlos  
Louche monobloc  
Cacillo monobloc

| art.     | Ø cm. | l. cm. | lt.  |
|----------|-------|--------|------|
| 11970-06 | 6,5   | 30     | 0,07 |
| 11970-08 | 8,0   | 32     | 0,12 |
| 11970-09 | 9,0   | 33     | 0,20 |
| 11970-10 | 10,0  | 37     | 0,25 |
| 11970-11 | 11,0  | 38     | 0,33 |
| 11970-12 | 12,0  | 40     | 0,50 |
| 11970-14 | 14,0  | 44     | 0,75 |
| 11970-16 | 16,0  | 47     | 1,00 |



NSF  
SS

**Ladle, tube handle**

Mestolo con manico a tubo  
Schöpflöffel mit Rohrstiel  
Louche avec manche tubulaire  
Cacillo con mango tubolar

| art.     | Ø cm. | l. cm. | lt. |
|----------|-------|--------|-----|
| 11968-18 | 18    | 75     | 1,5 |
| 11968-20 | 20    | 75     | 2,0 |
| 11968-24 | 24    | 75     | 4,0 |



NSF  
SS

**One piece perforated ladle**

Mestolo forato unipezzo  
Gelochter Schöpflöffel, fugenlos  
Louche monobloc perforée  
Cacillo monobloc perforado

| art.     | Ø cm. | l. cm. | lt.  |
|----------|-------|--------|------|
| 11967-06 | 7     | 30     | 0,07 |
| 11967-08 | 8     | 32     | 0,12 |
| 11967-09 | 9     | 33     | 0,20 |
| 11967-10 | 10    | 37     | 0,25 |
| 11967-12 | 12    | 40     | 0,50 |
| 11967-14 | 14    | 44     | 0,75 |
| 11967-16 | 16    | 47     | 1,00 |



NSF  
SS

**Perforated ladle, tube handle**

Mestolo forato con manico a tubo  
Schöpflöffel, gelocht mit Rohrstiel  
Louche perforée, manche tubulaire  
Cacillo perforado mango tubolar

| art.     | Ø cm. | l. cm. | lt. |
|----------|-------|--------|-----|
| 11967-18 | 18    | 75     | 1,5 |
| 11967-20 | 20    | 75     | 2,0 |
| 11967-24 | 24    | 75     | 4,0 |



NSF  
SS

**One piece side basting spoon**

Mestolo becco a versare unipezzo  
Saucenkelle quer, fugenlos  
Cuillère à arroser monobloc  
Cacillo monobloc para versar

| art.      | Ø cm. | l. cm. | lt.  |
|-----------|-------|--------|------|
| 11969-06  | 6,5   | 30     | 0,07 |
| 11969-37* | 6,5   | 30     | 0,07 |

\*Left handed. – Per mancini.



NSF  
SS

**One piece basting spoon**

Cucchiaione unipezzo  
Giesslöffel, fugenlos  
Cuillère monobloc  
Cucharón monobloc

| art.     | l. cm. |
|----------|--------|
| 11982-38 | 38     |



NSF  
SS

**One piece perforated spoon**

Cucchiaione forato unipezzo  
Giesslöffel perforiert, fugenlos  
Cuillère perforée monobloc  
Cucharón perforado monobloc

| art.     | l. cm. |
|----------|--------|
| 11984-38 | 38     |



NSF  
SS

**One piece spoon, crosswise**

Cucchiaione obliquo unipezzo  
Giesslöffel quer, fugenlos  
Cuillère oblique monobloc  
Cucharón obliquo monobloc

| art.      | l. cm. |
|-----------|--------|
| 11983-38  | 38     |
| 11983-37* | 38     |

\*Left handed. – Per mancini.



NSF  
SS

**One piece meat fork, 3 prongs**

Forchettone 3 denti unipezzo  
Fleischgabel 3 Zacken, fugenlos  
Fourchette 3 dents, monobloc  
Tenedor 3 dientes, monobloc

| art.     | l. cm. |
|----------|--------|
| 11974-50 | 50     |
| 11974-70 | 70     |



NSF  
SS

**One piece meat fork, 2 prongs**  
Forchettone 2 denti unipezzo  
Fleischgabel 2 Zacken, fugenlos  
Fourchette 2 dents, monobloc  
Tenedor 2 dientes, monobloc

| art.     | l. cm. |
|----------|--------|
| 11975-50 | 50     |
| 11975-99 | 100    |



NSF  
SS

**One piece spatula**  
Paletta liscia unipezzo  
Backschaufel, fugenlos  
Spatule monobloc  
Espátula lisa monobloc

| art.     | cm. | l. cm. |
|----------|-----|--------|
| 11972-10 | 10  | 36     |
| 11972-12 | 12  | 39     |



NSF  
SS

**One piece perforated spatula**  
Paletta forata unipezzo  
Backschaufel perforiert, fugenlos  
Spatule perforée monobloc  
Espátula perforada monobloc

| art.     | cm. | l. cm. |
|----------|-----|--------|
| 11973-10 | 10  | 36     |
| 11973-12 | 12  | 39     |



NSF  
SS

**Perforated slice**  
Pala a ridurre  
Reduzierspatel  
Spatule à réduire  
Espátula para reducir

| art.     | cm.   | l. cm. |
|----------|-------|--------|
| 11976-50 | 12x15 | 50     |
| 11976-99 | 12x15 | 100    |



NSF  
SS

**One piece fish spatula**  
Paletta pesce unipezzo, forata  
Fischwender, fugenlos  
Pelle à poisson monobloc  
Pala pescado, monobloc

| art.     | cm.   | l. cm. |
|----------|-------|--------|
| 11985-34 | 15x20 | 42     |



NSF  
SS

**One piece skimmer**  
Schiumarola unipezzo  
Schaumlöffel, fugenlos  
Ecumoire monobloc  
Espumadera monobloc

| art.     | Ø cm. | l. cm. |
|----------|-------|--------|
| 11971-08 | 8     | 29,0   |
| 11971-10 | 10    | 32,0   |
| 11971-12 | 12    | 35,0   |
| 11971-14 | 14    | 38,0   |
| 11971-16 | 16    | 41,0   |
| 11971-18 | 18    | 42,5   |
| 11971-20 | 20    | 44,5   |



NSF  
SS

**One piece skimmer, tube handle**  
Schiumarola unipezzo, manico a tubo  
Schaumlöffel, fugenlos, mit Rohrstiel  
Ecumoire monobloc, manche tubulaire  
Espumadera monobloc, mango tubolar

| art.     | Ø cm. | l. cm. |
|----------|-------|--------|
| 11971-25 | 25    | 75     |



NSF  
SS

**One piece ladle**  
Mestolo unipezzo  
Schöpföffel, fugenlos  
Louche monobloc  
Cacillo monobloc

| art.     | Ø cm. | l. cm. | lt.  |
|----------|-------|--------|------|
| 11970-01 | 8     | 23     | 0,12 |

Short handle. – Manico corto.



NSF  
SS

**Side basting spoon**  
Mestolo con becco a versare  
Saucenkelle mit seitlichem Ausguß  
Cuillère à arroser  
Cacillo para versar

| art.     | Ø cm. | l. cm. | lt.  |
|----------|-------|--------|------|
| 11969-02 | 6,5   | 23     | 0,07 |

Short handle. – Manico corto.



NSF  
SS

**One piece spoon**  
Cucchiaione unipezzo  
Giesslöffel, fugenlos  
Cuillère monobloc  
Cuchara monobloc

| art.     | l. cm. |
|----------|--------|
| 11982-01 | 23,5   |

Short handle. – Manico corto.



NSF  
SS

**One piece meat fork**  
Forchettone unipezzo  
Fleischgabel, fugenlos  
Fourchette monobloc  
Tenedor monobloc

| art.     | l. cm. |
|----------|--------|
| 11975-01 | 26     |

Short handle. – Manico corto.



NSF  
SS

**One piece perforated spatula**  
Paletta forata unipezzo  
Backschaufel perforiert, fugenlos  
Spatule perforée monobloc  
Espátula perforada monobloc

| art.     | cm.   | l. cm. |
|----------|-------|--------|
| 11973-01 | 8x9,5 | 24     |

Short handle. – Manico corto.



NSF  
SS

**One piece skimmer**  
Schiumarola unipezzo  
Schaumlöffel, fugenlos  
Ecumoire monobloc  
Espumadera monobloc

art. Ø cm. l. cm.  
11971-01 9 26

**Short handle. – Manico corto.**



SS

**Ladle**  
Mestolo  
Schöpflöffel  
Louche  
Cacillo

art. Ø cm. l. cm. lt.  
41670-06 6 30 0,03  
41670-09 9 32 0,13



SS

**Skimmer**  
Schiumarola  
Schaumlöffel  
Ecumoire  
Espumadera

art. Ø cm. l. cm.  
41671-11 11 32



SS

**Slotted turner**  
Paletta forata  
Küchenwender, geschlitzt  
Pelle ajourée  
Espátula perforada

art. l. cm.  
41672-00 32



SS

**Spaghetti spoon**  
Cucchiaio per spaghetti  
Spaghettilöffel  
Cuillère à spaghetti  
Tenedor espaguetis

art. l. cm.  
41673-00 32



SS

**Meat fork**  
Forchettone  
Fleischgabel  
Fourchette  
Tenedor

art. l. cm.  
41674-00 32



SS

**Basting spoon**  
Cucchiaione  
Giesslöffel  
Cuillère  
Cuchara

art. l. cm.  
41675-00 32



SS

**Perforated spoon**  
Cucchiaione forato  
Schöpfkelle, gelocht  
Cuillère percée  
Cuchara perforada

art. l. cm.  
41676-00 32



SS

**Sauce ladle**  
Cucchiaione salse  
Saucenkelle  
Cuillère à sauce  
Cuchara salsas

art. l. cm.  
41677-00 32



SS

**Whisk**  
Frusta  
Schneebesen  
Fouet  
Batidor

art. l. cm.  
41678-00 30



SS

**Wall rack**  
Asta  
Aufhängungstange  
Tringle de cuisine  
Asta para utensilios

art. l. cm.  
41670-AA 40  
41670-AB 60



SS

**Mesh skimmer**  
Schiumarola a rete stirata  
Schaumlöffel  
Ecumoire  
Espumadera

art. Ø cm. l. cm.  
11990-16 16 40



SS

**Mesh skimmer**  
Schiumarola a rete passabrodo  
Schaumlöffel  
Ecumoire  
Espumadera

art. Ø cm. l. cm.  
11991-16 16 40

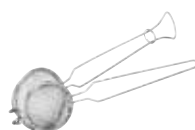

SS

**Bird nest fryer**  
Colafritto  
Nestbacklöffel  
Nid à friture  
Molde nido

art. Ø cm. l. cm.  
42623-10 10 26



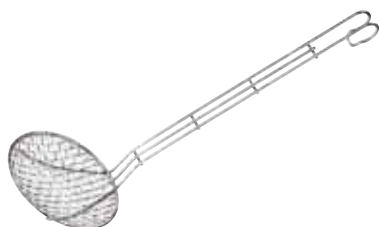

SS

**Wire skimmer**  
 Schiumarola a filo  
 Drahtlöffel  
 Araignée  
 Araña

| art.     | Ø cm. | l. cm. |
|----------|-------|--------|
| 12640-14 | 14    | 40     |
| 12640-16 | 16    | 40     |
| 12640-18 | 18    | 40     |
| 12640-20 | 20    | 50     |
| 12640-24 | 24    | 50     |
| 12640-28 | 28    | 50     |

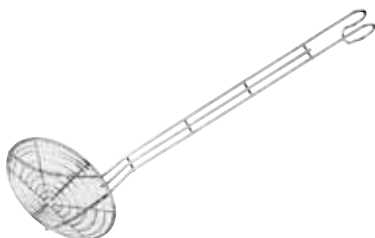

SS

**Wire skimmer**  
 Schiumarola a filo  
 Drahtlöffel  
 Araignée  
 Araña

| art.     | Ø cm. | l. cm. |
|----------|-------|--------|
| 12641-14 | 14    | 40     |
| 12641-16 | 16    | 40     |
| 12641-18 | 18    | 40     |
| 12641-20 | 20    | 50     |
| 12641-24 | 24    | 50     |
| 12641-28 | 28    | 50     |

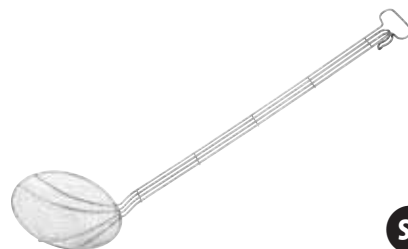

SS

**Wire skimmer**  
 Schiumarola a filo  
 Drahtlöffel  
 Araignée  
 Araña

| art.     | Ø cm. | l. cm. |
|----------|-------|--------|
| 12642-28 | 28    | 85     |



SS

**French fry scoop**  
 Pala per patate fritte  
 Frittenschaufel  
 Pelle à frites  
 Pala chips

| art.     | cm.   |
|----------|-------|
| 41929-00 | 20x23 |



ABS

**French fry scoop**  
 Pala per patate fritte  
 Frittenschaufel  
 Pelle à frites  
 Pala chips

| art.     |
|----------|
| 41929-02 |

Ambidextrous. – Ambidestro.



W

**Spatula**  
 Spatola  
 Schäber  
 Spatule  
 Espátula

| art.     | l. cm. |
|----------|--------|
| 42907-01 | 25     |
| 42907-02 | 30     |
| 42907-03 | 35     |
| 42907-04 | 40     |
| 42907-06 | 50     |
| 42907-07 | 60     |
| 42907-08 | 80     |
| 42907-09 | 100    |
| 42907-10 | 120    |



W

**Mixing spoon**  
 Cucchiavione  
 Löffel  
 Cuillère  
 Cuchara

| art.     | l. cm. |
|----------|--------|
| 42901-20 | 20     |
| 42901-25 | 25     |
| 42901-30 | 30     |
| 42901-35 | 35     |
| 42901-40 | 40     |



W

**Spatula**  
 Spatola  
 Schäber  
 Spatule  
 Espátula

| art.     | l. cm. |
|----------|--------|
| 42907-30 | 30     |
| 42907-35 | 35     |
| 42907-40 | 40     |



W

**Crepe spreader, 5 pcs**  
 Spatole crêpes, 5 pz  
 Crêpe-Paletten, 5 Stk  
 Rateau à crêpes/raclettes, 5 pcs  
 Espátula crêpes, 5 pz

| art.     | cm.   |
|----------|-------|
| 42900-15 | 18x18 |
| 42900-24 | 18x24 |

Beachwood. – Faggio.

**NEW**

**SS**

**PP**

**PS**



**SS**

**Baster tube**

Pompetta per sugo  
Soft-Spritzze  
Pompe à jus  
Bomba para jugo

| art.     | l. cm. |
|----------|--------|
| 42863-00 | 20     |



**Marinating syringe, graduated**

Siringa per marinata, graduata  
Marinierspritze, graduert  
Seringue à marinade, graduée  
Jeringa para marinar, graduada

| art.     | Ø cm. | l. cm. | ml. |
|----------|-------|--------|-----|
| 42862-00 | 3,5   | 24     | 30  |



**SS**

**Fish-bone remover**

Pinza togli lische  
Grätenentkerner  
Pince à arêtes  
Pinza para espinas

| art.     | l. cm. |
|----------|--------|
| 42592-01 | 12     |
| 42592-02 | 12     |

**01 thin bones, 02 thick bones.** – 01 lische fini, 02 lische grosse.



**SS**

**Cooking tong**

Pinza  
Kochzange  
Pinze  
Pinza

| art.     | l. cm. |
|----------|--------|
| 42904-01 | 16     |



**SS**

**Cooking tong**

Pinza  
Kochzange  
Pinze  
Pinza

| art.     | l. cm. |
|----------|--------|
| 42904-02 | 16     |



**SS**

**Cooking tong**

Pinza  
Kochzange  
Pinze  
Pinza

| art.     | l. cm. |
|----------|--------|
| 42904-03 | 15     |



**SS**

**Sausage tongs**

Pinza per grill  
Grill-und Wurstzange  
Pince à saucisses  
Pinza para barbacoa

| art.     | l. cm. |
|----------|--------|
| 41697-00 | 38     |



**SS**

**Cooking tong**

Pinza  
Kochzange  
Pinze  
Pinza

| art.     | l. cm. |
|----------|--------|
| 42902-31 | 30     |



**SS**

**Cooking tong**

Pinza  
Kochzange  
Pinze  
Pinza

| art.     | l. cm. |
|----------|--------|
| 42902-30 | 30     |



**SS**

**Grill tweezer**

Molla per grill  
Grillzange  
Pince à grill  
Pinza para barbacoa

| art.     | l. cm. |
|----------|--------|
| 41698-22 | 22,5   |
| 41698-30 | 30,0   |
| 41698-40 | 40,0   |



**SS**

**Serving tong**

Pinza a servire  
Servierzange  
Pince à servir  
Pinza para servir

| art.     | l. cm. |
|----------|--------|
| 42854C25 | 25     |
| 42854C30 | 30     |



**SS**

**Serving tong**

Pinza a servire  
Servierzange  
Pince à servir  
Pinza para servir

| art.     | l. cm. |
|----------|--------|
| 42854B25 | 25     |
| 42854B30 | 30     |





SS

**Serving tong**  
Pinza a servire  
Servierzange  
Pince à servir  
Pinza para servir

| art.     | l. cm. |
|----------|--------|
| 42854Y25 | 25     |
| 42854Y30 | 30     |



SS

**Serving tong**  
Pinza a servire  
Servierzange  
Pince à servir  
Pinza para servir

| art.     | l. cm. |
|----------|--------|
| 42854K25 | 25     |
| 42854K30 | 30     |



SS

**Serving tong**  
Pinza a servire  
Servierzange  
Pince à servir  
Pinza para servir

| art.     | l. cm. |
|----------|--------|
| 42854R25 | 25     |
| 42854R30 | 30     |



SS

**Serving tong**  
Pinza a servire  
Servierzange  
Pince à servir  
Pinza para servir

| art.     | l. cm. |
|----------|--------|
| 42854G25 | 25     |
| 42854G30 | 30     |



**Cooking tong, silicone**  
Pinza, silicone  
Kochzange aus Silikon  
Pince en silicone  
Pinza de silicona

| art.     | l. cm. |
|----------|--------|
| 42903-29 | 29     |



**Barbecue brush**  
Spazzola grill  
Grill-Bürste  
Brosse à grille  
Cepillo para barbacoa

| art.     | cm.    | l. cm. |
|----------|--------|--------|
| 41773-00 | 5,5x11 | 27     |

Brass bristles. – Setole in ottone.



SS

**Whisk for basin**  
Frusta gigante  
Kesselbesen  
Fouet à bassine  
Batidor gigante

| art.     | l. cm. |
|----------|--------|
| 41980-99 | 125    |



**Food-grade resin spatula**  
Spatola in resina alimentare  
Rührspaten für Speisenzubereitung  
Spatule en résine pour aliments  
Espátula de resina para alimentos

| art.     | cm.       | l. cm. |
|----------|-----------|--------|
| 44061-08 | 15,7x10,8 | 80     |
| 44061-09 | 23,5x10,8 | 90     |
| 44061-12 | 23,5x10,8 | 117    |
| 44061-14 | 23,5x10,8 | 137    |



SS

**Speed rack**  
Rastrelliera  
Flaschenregal  
Rack à bouteilles  
Rack de botellas

| art.     | cm.     | h.   | bot. |
|----------|---------|------|------|
| 44060-50 | 56x10,5 | 15,5 | 6    |
| 44060-80 | 81x10,5 | 15,5 | 8    |



SS

**Hat pin for tickets**  
Spillone portascontrini  
Kassenscheine-Aufstecknadel  
Pique-addition  
Pinchanotas

| art.     | Ø cm. | h. |
|----------|-------|----|
| 12504-20 | 9     | 20 |



W

**Hat pin for tickets**  
Spillone portascontrini  
Kassenscheine-Aufstecknadel  
Pique-addition  
Pinchanotas

| art.     | cm.   | l. cm. |
|----------|-------|--------|
| 42504-09 | 9x5,5 | 10,5   |



SS

**Tickets-holder**  
Asta portascontrini  
Bons-/Zettelhalter  
Porte-fiches à billes  
Barra de notas

| art.     | l. cm. |
|----------|--------|
| 42509-25 | 25     |
| 42509-50 | 50     |



SS

**Tab-grabber**  
Asta porta scontrini  
Bons-/Zettelhalter  
Porte-fiches  
Barra de notas

| art.     | l. cm. |
|----------|--------|
| 42509-60 | 60     |
| 42509-99 | 100    |



SS

**Roll holder**  
Porta rotolo  
Rollenhalter  
Derouleur papier  
Portarollos

| art.     | l. cm. |
|----------|--------|
| 42512-35 | 30     |



SS

**Wall film box**  
Supporto murale, porta pellicola  
Wand-Folien-Abreißgerät  
Dérouleur de film mural  
Soporte de pared para film

| art.     | l. cm. |
|----------|--------|
| 42513-30 | 30     |
| 42513-45 | 45     |

**Roll max ø cm 13. – Rotolo ø max. cm 13.**



PP

**Additional plate stand**  
Anello distanziatore  
Gestell für Zusatzteller  
Support assiette supplémentaire  
Soporte distanciador

| art.     | Ø cm. | h. |
|----------|-------|----|
| 47605-23 | 19-21 | 6  |



PP

**Plate cover**  
Copripiatto  
Tellerglocke  
Cloche  
Cubreplatos

| art.     | Ø cm. | h.  |
|----------|-------|-----|
| 47603-25 | 25    | 6,5 |
| 47603-27 | 27    | 6,5 |
| 44998-31 | 31    | 6,5 |



PC

**Plate cover**  
Copripiatto  
Tellerglocke  
Cloche  
Cubreplatos

| art.     | Ø cm. | h.  |
|----------|-------|-----|
| 44997-22 | 21    | 6,8 |
| 44997-24 | 23    | 6,8 |
| 44997-26 | 26    | 6,8 |
| 44997-28 | 28    | 6,8 |



SS

**Plate cover**  
Copripiatto  
Tellerglocke  
Cloche  
Cubreplatos

| art.     | Ø cm. | h.  |
|----------|-------|-----|
| 41683-26 | 26,5  | 4,3 |



SS

**Funnel**  
Imbuto  
Trichter  
Entonnoir  
Embudo

| art.     | Ø cm. |
|----------|-------|
| 42562-12 | 12    |
| 42562-14 | 14    |
| 42562-16 | 16    |
| 42562-18 | 18    |
| 42562-20 | 20    |
| 42562-25 | 25    |
| 42562-30 | 30    |





PP

**Funnel**  
Imbuto  
Trichter  
Entonnoir  
Embudo

| art.     | Ø cm. |
|----------|-------|
| 47604-08 | 8     |
| 47604-10 | 10    |
| 47604-12 | 12    |
| 47604-15 | 15    |
| 47604-18 | 18    |
| 47604-20 | 20    |
| 47604-24 | 24    |
| 47604-30 | 30    |



PP

**Measuring jug**  
Caraffa graduata  
Messbecher  
Pichet gradué  
Jarra de medidas

| art.     | Ø cm. | h. | lt. |
|----------|-------|----|-----|
| 47608-02 | 19    | 12 | 2,2 |



PP

**Measuring jug**  
Caraffa graduata  
Messbecher  
Pichet gradué  
Jarra de medidas

| art.     | Ø cm. | h.   | lt.  |
|----------|-------|------|------|
| 47606-02 | 8,5   | 10,0 | 0,25 |
| 47606-05 | 10,5  | 10,5 | 0,50 |
| 47606-10 | 12,5  | 14,5 | 1,00 |
| 47606-20 | 13,5  | 17,0 | 2,00 |
| 47606-30 | 15,5  | 21,0 | 3,00 |
| 47606-50 | 19,0  | 24,0 | 5,00 |



PP

**Measuring jug**  
Caraffa graduata  
Messbecher  
Pichet gradué  
Jarra de medidas

| art.     | Ø cm. | h.   | lt. |
|----------|-------|------|-----|
| 47607-10 | 12,5  | 14,5 | 1   |
| 47607-20 | 13,5  | 17,0 | 2   |

**Lt. and ml. scale. Heat resistant up to 95°C.**  
Scala in lt e ml. Resistente fino a 95°C.



SS

**Graduated measure jug**  
Misurino graduato  
Messbecher, graduert  
Mesure graduée  
Jarra de medidas

| art.     | Ø cm. | h. | lt. |
|----------|-------|----|-----|
| 42581-01 | 7,5   | 5  | 0,1 |
| 42581-03 | 10,0  | 7  | 0,3 |
| 42581-05 | 11,5  | 11 | 0,5 |
| 42581-10 | 15,0  | 13 | 1,0 |
| 42581-15 | 15,5  | 15 | 1,5 |
| 42581-20 | 17    | 19 | 2,0 |



SS

**Measuring spoons, 4 pcs**  
Misurini set 4 pz  
Messlöffel Set 4-tlg.  
Cuillères à mesurer 4 pcs  
Cucharas medidoras 4 pz

| art.     | ml.        |
|----------|------------|
| 42615-04 | 1-2,5-5-15 |



SS

**Measuring cups, 4 pcs**  
Misurini set 4 pz  
Messlöffel Set 4-tlg.  
Cuillères à mesurer 4 pcs  
Cucharas medidoras 4 pz

| art.     | ml.           |
|----------|---------------|
| 42616-04 | 60-80-125-250 |



SS

**Lever dispenser**  
Dosatore  
Hebeldosierspender  
Distributeur à manette  
Dispensador

| art.     | Ø cm. | h.   |
|----------|-------|------|
| 41528-21 | 21    | 22,5 |
| 41528-22 | 22    | 18,0 |

**Suitable for 5 kg bucket. – Per bidone da kg 5.**



AY

**Dispenser**  
Dosatore  
Dosierspender  
Doseur  
Dispensador

| art.     | ml.  |
|----------|------|
| 47609-02 | 250  |
| 47609-03 | 350  |
| 47609-09 | 950  |
| 47609-13 | 1350 |



**AY**

**Dispenser**

Dosatore  
Dosierspender  
Doseur  
Dispensador

| art.     | ml.  |
|----------|------|
| 47609-04 | 375  |
| 47609-07 | 750  |
| 47609-12 | 1250 |
| 47609-16 | 1650 |



**PE**

**Squeeze bottle**

Flacone dosatore  
Quetschflasche  
Flacon doseur  
Frasco dosificador

| art.     | ml. | col. |
|----------|-----|------|
| 41526-R1 | 240 | ●    |
| 41526-R2 | 360 | ●    |
| 41526-R3 | 720 | ●    |



**PE**

**Squeeze bottle**

Flacone dosatore  
Quetschflasche  
Flacon doseur  
Frasco dosificador

| art.     | ml. | col. |
|----------|-----|------|
| 41526-B1 | 240 | ○    |
| 41526-B2 | 360 | ○    |
| 41526-B3 | 720 | ○    |



**PE**

**Squeeze bottle**

Flacone dosatore  
Quetschflasche  
Flacon doseur  
Frasco dosificador

| art.     | ml. | col. |
|----------|-----|------|
| 41526-G1 | 240 | ●    |
| 41526-G2 | 360 | ●    |
| 41526-G3 | 720 | ●    |



**PE**

**Squeeze bottle, 4 pcs**

Flacone dosatore, 4 pz  
Quetschflasche, 4 Stk  
Flacon doseur, 4 pcs  
Frasco dosificador, 4 pz

| art.     | Ø cm. | h.  | ml. |
|----------|-------|-----|-----|
| 41526-01 | 3     | 8,5 | 30  |



**PE**

**Squeeze bottle, 4 pcs**

Flacone dosatore, 4 pz  
Quetschflasche, 4 Stk  
Flacon doseur, 4 pcs  
Frasco dosificador, 4 pz

| art.     | Ø cm. | h.  | ml. |
|----------|-------|-----|-----|
| 41526-02 | 3,5   | 9,5 | 50  |



**PE**

**Squeeze bottle**

Flacone dosatore  
Quetschflasche  
Flacon doseur  
Frasco dosificador

| art.     | Ø cm. | h. | ml. |
|----------|-------|----|-----|
| 41526-05 | 5,0   | 18 | 200 |
| 41526-06 | 5,5   | 19 | 350 |



**PE**

**Triple nozzle squeeze bottle**

Flacone dosatore, triplo ugello  
Quetschflasche mit Dreifachdüse  
Flacon doseur à trois becs  
Frasco dosificador 3 boquillas

| art.     | ml. | col. |
|----------|-----|------|
| 41520-08 | 235 | ○    |
| 41520-12 | 355 | ○    |
| 41520-16 | 470 | ○    |
| 41520-24 | 700 | ○    |



**SS**

**Decorating spoons 2 pcs**

Cucchiari decorazione 2 pz  
Dekoration-Löffel 2 Stk  
Cuillères pour décorer 2 pcs  
Cucharas para decoración 2 pz

| art.     | l. cm. |
|----------|--------|
| 47831-02 | 19-23  |



SS

**Flour scoop**

Sessola tonda  
Mehlschaufel  
Pelle à farine  
Librador

| art.     | lt.  |
|----------|------|
| 42609-10 | 0,10 |
| 42609-15 | 0,40 |
| 42609-20 | 1,00 |
| 42609-23 | 1,70 |
| 42609-25 | 2,80 |



PP

**Flour scoop**

Sessola  
Mehlschaufel  
Pelle à farine  
Librador

| art.     | cm.      | lt.  |
|----------|----------|------|
| 17610-01 | 20x7     | 0,10 |
| 17610-02 | 27,5x9,5 | 0,25 |
| 17610-05 | 32,5x12  | 0,50 |
| 17610-10 | 39x15    | 1,00 |



PA+ plus

**Flour scoop**

Sessola  
Mehlschaufel  
Pelle à farine  
Librador

| art.     | cm.      | lt.  |
|----------|----------|------|
| 12940-02 | 27,5x9,5 | 0,25 |
| 12940-05 | 32,5x12  | 0,50 |
| 12940-10 | 39x15    | 1,00 |
| 12940-20 | 48x18    | 2,00 |
| 12940-25 | 50x19,5  | 2,50 |



SS

**Sieve with spare gauzes**

Setaccio rete intercambiabile  
Sieb mit auswechselbarem Siebeinsatz  
Tamis avec toiles de rechange  
Cernidor con red intercambiabile

| art.     | Ø cm. | Ø mm. |
|----------|-------|-------|
| 42590-02 | 30    | *1,1  |
| 42590-03 | 30    | *0,9  |

\*Mesh. – Rete.



SS

**Spare gauzes**

Rete intercambiabile  
Auswechselbarem Siebeinsatz  
Toiles de rechange  
Red intercambiabile

| art.     | Ø cm. | Ø mm. |
|----------|-------|-------|
| 42590R02 | 30    | *1,1  |
| 42590R03 | 30    | *0,9  |

\*Mesh. – Rete.



SS

**Bread sieve**

Setaccio pane  
Brot sieb  
Tamis à pain  
Cernidor para pan

| art.     | Ø cm. | h. |
|----------|-------|----|
| 12604-22 | 22    | 8  |
| 12604-30 | 30    | 8  |
| 12604-34 | 34    | 8  |
| 12604-40 | 40    | 8  |

8 eye per inch. – 8 fori per 2,5 cm2.



SS

**Flour sieve**

Setaccio farina  
Mehlsieb  
Tamis à farine  
Cernidor para harina

| art.     | Ø cm. | h. |
|----------|-------|----|
| 12605-22 | 22    | 8  |
| 12605-30 | 30    | 8  |
| 12605-34 | 34    | 8  |
| 12605-40 | 40    | 8  |

20 eye per inch. – 20 fori per 2,5 cm2.



SS

**Sieve**

Setaccio infarina pesce  
Sieb  
Tamis  
Cernidor

| art.     | Ø cm. | h. |
|----------|-------|----|
| 12606-30 | 30    | 8  |
| 12606-34 | 34    | 8  |

4 eye per inch. – 4 fori per 2,5 cm2.



SS

**Sieve**

Setaccio rete pasticciare  
Sieb  
Tamis  
Cernidor

| art.     | Ø cm. | h. |
|----------|-------|----|
| 12607-22 | 22    | 8  |
| 12607-30 | 30    | 8  |
| 12607-34 | 34    | 8  |

10 eye per inch. – 10 fori per 2,5 cm2.



SS

**Kitchenbowl, with handles**

Bacinella conica con maniglie  
Schüssel mit Griffen  
Bassine conique avec anses  
Caldero cónico con asas

| art.     | Ø cm. | h.   | lt.  |
|----------|-------|------|------|
| 11955-32 | 32    | 16,0 | 8,8  |
| 11955-36 | 36    | 18,5 | 12,8 |
| 11955-40 | 40    | 20,0 | 17,0 |
| 11955-45 | 45    | 22,5 | 24,5 |
| 11955-50 | 50    | 24,0 | 32,5 |



SS

**Conical colander**

Colapasta tronco conico  
Gemüsesieher  
Passoire à légumes  
Colador cónico

| art.     | Ø cm. | h.   | lt.  |
|----------|-------|------|------|
| 11930-24 | 24    | 12,0 | 3,5  |
| 11930-28 | 28    | 14,0 | 5,5  |
| 11930-32 | 32    | 16,0 | 8,8  |
| 11930-36 | 36    | 18,5 | 12,8 |
| 11930-40 | 40    | 20,0 | 17,0 |
| 11930-45 | 45    | 22,5 | 24,5 |
| 11930-50 | 50    | 24,0 | 32,5 |



SS

**Conical colander**

Colapasta tronco conico  
Gemüsesieher  
Passoire à légumes  
Colador cónico

| art.     | Ø cm. | h.   | lt.  |
|----------|-------|------|------|
| 11927-24 | 24    | 12,0 | 3,5  |
| 11927-28 | 28    | 14,0 | 5,5  |
| 11927-32 | 32    | 16,0 | 8,8  |
| 11927-36 | 36    | 18,5 | 12,8 |
| 11927-40 | 40    | 20,0 | 17,0 |
| 11927-45 | 45    | 22,5 | 24,5 |
| 11927-50 | 50    | 24,0 | 32,5 |



SS

**Hemispherical mixing bowl**

Bacinella semisferica  
Schüssel  
Bassine demi-ronde  
Caldero semiesférico

| art.     | Ø cm. | lt.  |
|----------|-------|------|
| 11957-20 | 20    | 2,0  |
| 11957-25 | 25    | 3,7  |
| 11957-30 | 30    | 7,2  |
| 11957-35 | 35    | 10,5 |
| 11957-40 | 40    | 15,6 |



NSF

SS

**Kitchenbowl low**

Bacinella conica bassa  
Schüssel, flach  
Bassine  
Caldero cónico

| art.     | Ø cm. | h.   | lt.  |
|----------|-------|------|------|
| 12582-13 | 13,2  | 6,0  | 0,5  |
| 12582-17 | 16,5  | 7,5  | 1,0  |
| 12582-22 | 22,0  | 7,5  | 2,0  |
| 12582-24 | 24,0  | 9,5  | 3,0  |
| 12582-32 | 30,5  | 11,5 | 6,0  |
| 12582-34 | 32,5  | 14,0 | 8,0  |
| 12582-38 | 38,0  | 13,5 | 11,0 |
| 12582-40 | 40,0  | 15,0 | 14,0 |



NSF

SS

**Kitchenbowl high**

Bacinella conica alta  
Tiefe Schüssel  
Bassine haute  
Caldero cónico alto

| art.     | Ø cm. | h.   | lt.  |
|----------|-------|------|------|
| 12580-11 | 11,7  | 7,0  | 0,5  |
| 12580-17 | 15,5  | 9,0  | 1,0  |
| 12580-21 | 19,0  | 11,5 | 2,0  |
| 12580-24 | 22,0  | 12,0 | 3,0  |
| 12580-29 | 27,0  | 13,5 | 5,0  |
| 12580-30 | 29,0  | 15,0 | 6,0  |
| 12580-31 | 30,5  | 17,0 | 8,0  |
| 12580-36 | 35,5  | 18,5 | 11,0 |
| 12580-40 | 40,0  | 20,0 | 17,0 |
| 12580-45 | 45,0  | 22,0 | 25,0 |
| 12580-50 | 50,0  | 24,0 | 33,0 |



PA+  
plus

**Conical colander**

Colatutto tronco conico  
Gemüsesieher  
Passoire à légumes  
Colador cónico

| art.     | Ø cm. | h. | lt. |
|----------|-------|----|-----|
| 12950-32 | 32    | 16 | 8   |
| 12950-40 | 40    | 20 | 12  |



**Conical colander, aluminium**

Colapasta tronco conico, alluminio  
Gemüsesieher, Aluminium  
Passoire à légumes, alu  
Colador cónico, aluminio

| art.     | Ø cm. | h.   | lt.  |
|----------|-------|------|------|
| 16927-32 | 32    | 16,0 | 8,8  |
| 16927-36 | 36    | 18,5 | 12,8 |
| 16927-40 | 40    | 20,0 | 17,0 |
| 16927-45 | 45    | 22,5 | 24,5 |
| 16927-50 | 50    | 24,0 | 32,5 |



SS

**Colander**

Colapasta con cerchio  
Gemüsesieher  
Passoire à légumes  
Colador con base

| art.     | Ø cm. | h.   | lt.  |
|----------|-------|------|------|
| 11928-32 | 32    | 18,0 | 9,5  |
| 11928-36 | 36    | 19,0 | 12,0 |
| 11928-40 | 40    | 21,0 | 14,5 |



SS

**Strainer**

Colapasta semisferico  
Stielsieb  
Passoire hémispherique  
Colador semiesférico

| art.     | Ø cm. | h. | lt. |
|----------|-------|----|-----|
| 11926-22 | 22    | 12 | 2,7 |
| 11926-26 | 26    | 14 | 4,0 |



SS

**Strainer**

Colapasta  
Stielsieb  
Passoire  
Colador

| art.     | Ø cm. | h. | lt. |
|----------|-------|----|-----|
| 11924-18 | 18    | 11 | 2,8 |
| 11924-20 | 20    | 12 | 3,6 |
| 11924-22 | 22    | 13 | 5,0 |
| 11924-24 | 24    | 14 | 6,5 |
| 11924-28 | 28    | 15 | 9,3 |



**Strainer, aluminium**

Colapasta, alluminio  
Stielsieb, Aluminium  
Passoire, alu  
Colador, aluminio

| art.     | Ø cm. | h. | lt. |
|----------|-------|----|-----|
| 16924-20 | 20    | 11 | 3,2 |
| 16924-24 | 24    | 13 | 6,0 |
| 16924-28 | 28    | 15 | 9,3 |



PP

**Strainer**

Colapasta  
Stielsieb  
Passoire  
Colador

| art.     | Ø cm. |
|----------|-------|
| 47610-22 | 22    |
| 47610-26 | 26    |
| 47610-30 | 30    |



PP

**Strainer**

Colapasta  
Stielsieb  
Passoire  
Colador

| art.     | Ø cm. |
|----------|-------|
| 47610-18 | 18    |



PE

**Graduated bucket**

Secchio graduato  
Eimer mit Skala  
Seau gradué  
Cubo con medidas

| art.     | Ø cm. | h.   | lt. |
|----------|-------|------|-----|
| 49889-09 | 27    | 26,2 | 9   |
| 49889-12 | 29    | 29,0 | 12  |
| 49889-15 | 31    | 30,8 | 15  |

With spout. – Con becco.



SS

**Graduated bucket**

Secchio graduato  
Eimer mit Skala  
Seau gradué  
Cubo con medidas

| art.     | Ø cm. | h.   | lt. |
|----------|-------|------|-----|
| 41960-08 | 28,5  | 20,5 | 8   |
| 41960-10 | 30,0  | 25,0 | 10  |
| 41960-12 | 31,0  | 27,0 | 12  |
| 41960-15 | 32,5  | 31,0 | 15  |



SS

**Graduated bucket with bottom ring**

Secchio graduato con base  
Eimer mit Fuss u. Skala  
Seau gradué avec base  
Cubo con medidas y base

| art.     | Ø cm. | h.   | lt. |
|----------|-------|------|-----|
| 41961-10 | 30,0  | 26,5 | 10  |
| 41961-12 | 31,0  | 28,5 | 12  |
| 41961-15 | 32,5  | 32,5 | 15  |



SS

**Lid for bucket**

Coperchio per secchio  
Deckel für Eimer  
Couverture pour seau  
Tapa para cubo

| art.     | Ø cm. |
|----------|-------|
| 41962-10 | 30,0  |
| 41962-12 | 31,0  |
| 41962-15 | 32,5  |



PE

**Mixing bowl**

Bacinella tonda  
Schüssel  
Bassine ronde  
Caldero semiesférico

| art.     | Ø cm. | h.   | lt.  |
|----------|-------|------|------|
| 47600-16 | 16    | 7,0  | 0,9  |
| 47600-20 | 20    | 8,5  | 1,6  |
| 47600-24 | 24    | 10,0 | 2,8  |
| 47600-28 | 28    | 11,0 | 4,5  |
| 47600-32 | 32    | 12,5 | 6,5  |
| 47600-36 | 36    | 14,0 | 10,0 |
| 47600-40 | 40    | 15,5 | 13,5 |



PP

**Mixing bowl**

Bacinella tonda  
Schüssel  
Bassine ronde  
Caldero semiesférico

| art.     | Ø cm. | h.   | lt.  |
|----------|-------|------|------|
| 47611-01 | 19,0  | 7,9  | 1,0  |
| 47611-03 | 24,0  | 11,5 | 2,5  |
| 47611-05 | 28,0  | 13,5 | 4,5  |
| 47611-06 | 32,5  | 14,7 | 6,0  |
| 47611-09 | 36,0  | 16,5 | 9,0  |
| 47611-13 | 40,0  | 18,5 | 13,0 |



PP

**Lid**

Coperchio  
Deckel  
Couvercle  
Tapa

| art.     | Ø cm. |
|----------|-------|
| 47611-11 | 19,0  |
| 47611-14 | 24,0  |
| 47611-15 | 28,0  |
| 47611-16 | 32,5  |
| 47611-19 | 36,0  |
| 47611-23 | 40,0  |



SS

**Mixing bowl**

Bastardella semisferica  
Schneeslagkessel  
Bassine hémispherique  
Caldero con asas

| art.     | Ø cm. | h.   | lt.  |
|----------|-------|------|------|
| 11952-22 | 22    | 12,0 | 2,7  |
| 11952-26 | 26    | 14,0 | 4,0  |
| 11952-32 | 32    | 18,0 | 9,5  |
| 11952-36 | 36    | 20,5 | 14,0 |
| 11952-40 | 40    | 21,5 | 18,0 |



SS

**Mixing bowl without handles**

Bastardella senza maniglie  
Schneeslagkessel ohne Griffe  
Bassine hémispherique sans anses  
Caldero sin asas

| art.     | Ø cm. | h.   | lt.  |
|----------|-------|------|------|
| 11951-22 | 22    | 12,0 | 2,7  |
| 11951-26 | 26    | 14,0 | 4,0  |
| 11951-32 | 32    | 18,0 | 9,5  |
| 11951-36 | 36    | 20,5 | 14,0 |
| 11951-40 | 40    | 21,5 | 18,0 |



SS

**Foot for mixing bowl**

Base per bastardella  
Fuss für Schneeslagkessel  
Base pour bassine hémispherique  
Base para caldero

| art.     | Ø cm. | for/per Ø |
|----------|-------|-----------|
| 11953-16 | 16    | 22-26     |
| 11953-22 | 22    | 32-36-40  |



SS

**Kettle for mixing machines**

Bacinella per planetaria  
Schlagmaschinenkessel  
Bol pour mélangeurs  
Caldero para batidera

| art.     | Ø cm. | h.   | lt.  |
|----------|-------|------|------|
| 11954-26 | 26    | 20,0 | 10,0 |
| 11954-30 | 30    | 25,0 | 16,0 |
| 11954-32 | 32    | 30,0 | 20,0 |
| 11954-36 | 36    | 28,5 | 25,0 |
| 11954-37 | 36    | 35,0 | 32,0 |
| 11954-40 | 40    | 35,5 | 40,0 |



SS

**Kitchen bowl with handle**

Tazzone con manico  
Schlagschüssel mit Rohrstiel  
Bol avec manche  
Cazo bombeado

| art.     | Ø cm. | h.   | lt. |
|----------|-------|------|-----|
| 41916-10 | 15    | 8,0  | 1,0 |
| 41916-15 | 17    | 9,0  | 1,2 |
| 41916-20 | 19    | 10,0 | 2,0 |



**Induction adapter**

Adattatore induzione  
Induktion Adapterplatte  
Disque relais pour induction  
Adaptador para inducción

| art.     | Ø cm. |
|----------|-------|
| 41922-16 | 16    |
| 41922-22 | 20    |





**Manual salad spinner**

Centrifuga manuale per verdura  
Salatschleuder  
Essoreuse manuelle à salade  
Centrifugadora de ensalada

| art.     | Ø cm. | h. | lt. |
|----------|-------|----|-----|
| 49888-10 | 33    | 43 | 12  |
| 49888-20 | 43    | 52 | 25  |



SS

**Soup strainer**

Colino a rete  
Suppensieb  
Passe-bouillon  
Colador a red

| art.     | Ø cm. | l. cm. |
|----------|-------|--------|
| 12622-07 | 7     | 12     |
| 12622-10 | 10    | 12     |
| 12622-12 | 12    | 17     |
| 12622-14 | 14    | 17     |
| 12622-16 | 16    | 17     |
| 12622-18 | 18    | 17     |
| 12622-20 | 20    | 17     |
| 12622-23 | 23    | 27     |
| 12622-26 | 26    | 27     |



SS

**Strainer, double mesh**

Colapasta doppia rete  
Passiersieb, doppelnetz  
Passoire, maille double  
Colador doble red

| art.     | Ø cm. | l. cm. |
|----------|-------|--------|
| 12633-16 | 16    | 17     |
| 12633-18 | 18    | 17     |
| 12633-20 | 20    | 17     |
| 12633-23 | 23    | 27     |
| 12633-26 | 26    | 27     |



SS

**Strainer**

Colatutto  
Sieb  
Passoire  
Colador multiuso

| art.     | cm.   | l. cm. |
|----------|-------|--------|
| 12630-22 | 22x18 | 19     |



SS

**Strainer**

Colino  
Sieb  
Passoire  
Colador

| art.     | Ø cm. |
|----------|-------|
| 41570-10 | 8     |



SS

**Strainer, reinforced**

Colapasta rinforzato  
Grossküchensieb mit Verstärkung  
Passoire renforcé  
Colador reforzado

| art.     | Ø cm. | l. cm. |
|----------|-------|--------|
| 12635-23 | 23    | 27     |
| 12635-26 | 26    | 27     |
| 12635-30 | 30    | 44     |
| 12635-35 | 35    | 44     |



SS

**Vegetable sieve**

Passaverdura  
Passiergerät  
Mini hache-tout  
Pasa verdura

| art.     | Ø cm. |
|----------|-------|
| 12638-20 | 20    |



SS

**Strainer**

Colatutto gigante  
Grossküchensieb  
Passoire géant  
Colador multiuso gigante

| art.     | Ø cm. | l. cm. |
|----------|-------|--------|
| 12636-32 | 32    | 60     |



SS

**Chinese colander**

Cornetto cinese  
Spitzsieb  
Passoire chinois  
Colador chino

| art.     | Ø cm. |
|----------|-------|
| 41925-14 | 14    |
| 41925-16 | 16    |
| 41925-18 | 18    |
| 41925-20 | 20    |
| 41925-22 | 22    |
| 41925-24 | 24    |
| 41925-26 | 26    |



SS

**Chinese colander stand**  
Supporto per cornetto cinese  
Träger für Spitzsieb  
Support chinois  
Soporte para colador chino

| art.     | Ø cm. | h. |
|----------|-------|----|
| 41933-18 | 18    | 28 |



SS

**Colander with wire gauze**  
Cornetto cinese a rete  
Gazensieb  
Chinois à gaze  
Colador chino a red

| art.     | Ø cm. |
|----------|-------|
| 11929-20 | 20    |
| 11929-24 | 24    |



SS

**Chinese colander with wire protection**  
Cornetto con protezione  
Spitzsieb mit Verstärkung  
Chinois à gaze avec renfort  
Colador chino con protección

| art.     | Ø cm. |
|----------|-------|
| 11932-20 | 20    |
| 11932-24 | 24    |



SS

**Chinese soup strainer**  
Collino conico a rete  
Suppen-Spitzsieb  
Passe-bouillon chinois  
Colador cónico a red

| art.     | Ø cm. |
|----------|-------|
| 41931-08 | 8     |
| 41931-14 | 14    |
| 41931-16 | 16    |
| 41931-18 | 18    |



**Bouillon cloth**  
Panno passabrodo  
Bouillonstoffsieb  
Etamine passe-bouillon  
Paño para pasar caldo

| art.     | cm.   | U. Pack |
|----------|-------|---------|
| 41932-05 | 87x70 | 5       |

**Twisted cotton cloth with seam.**  
Tela di cotone ritorto, orlata.



ABS

**Rice scoop**  
Porzionatore  
Reis-Portionierer  
Portionneur  
Racionador

| art.     | h.  | gr.     |
|----------|-----|---------|
| 42653-04 | 4,5 | 120-130 |



**PA+**  
plus

**Portion ring**  
Anello per impiattare  
Portionierspeisering  
Cercle portionneur  
Anillo porcionador

| art.     | Ø cm. | h.  |
|----------|-------|-----|
| 12943-03 | 3     | 3,5 |
| 12943-05 | 5     | 3,5 |
| 12943-07 | 7     | 3,5 |
| 12943-08 | 8     | 3,5 |
| 12943-10 | 10    | 3,5 |
| 12943-12 | 12    | 3,5 |



**PA+**  
plus

**Portion ring**  
Anello per impiattare  
Portionierspeisering  
Cercle portionneur  
Anillo porcionador

| art.     | Ø cm. | h.  |
|----------|-------|-----|
| 12944-03 | 3     | 3,5 |
| 12944-05 | 5     | 3,5 |
| 12944-07 | 7     | 3,5 |
| 12944-08 | 8     | 3,5 |
| 12944-10 | 10    | 3,5 |
| 12944-12 | 12    | 3,5 |



PP

**Bag clip**  
Clip chiudi sacco  
Verschluss-Clip  
Clip ferme sachet  
Pinza cierra bolsas

| art.     | l. cm. | pcs/pz |
|----------|--------|--------|
| 42908-24 | 24     | 1      |

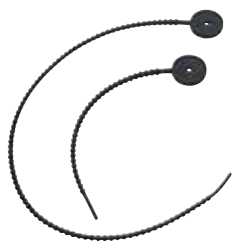

**Foodloops, silicone, 6 pcs**

Laccetti da cucina, silicone, 6 pz  
Silikonbänder, 6 Stk  
Lacets de cuisson, silicone, 6 pcs  
Lazos de silicona de cocina, 6 pz

| art.     | l. cm. |
|----------|--------|
| 41595B44 | 22     |
| 41595B45 | 53     |



**Presse canard, bronzo**

Presse canard, bronzo  
Presse canard, Bronze  
Presse à canard, bronze  
Prensador para canard, bronzo

| art.     | h. | Kg. |
|----------|----|-----|
| 49845-01 | 52 | 16  |

Tinned. – Stagnato.



**Octopus-press**

Pressapolipo  
Krake-Press  
Presse à poulpe  
Prensador para pulpo

| art.     | Ø cm. | h.   |
|----------|-------|------|
| 49760-00 | 10,5  | 20,5 |



**Mini-guitar**

Mini-chitarra  
Mini-Guitare  
Mini-guitare  
Mini guitarra

| art.     | cm.      | Kg. |
|----------|----------|-----|
| 49839-00 | 45x23x15 | 4,9 |

For products with tender and homogeneous consistency. Cut width 14,5 cm, thickness 5 mm.  
Per prodotti teneri ma di consistenza omogenea.  
Larghezza taglio 14,5 cm, spessore 5 mm.



**Tomato cutter**

Affetta pomodori  
Tomatenschneider  
Coupe-tomates  
Cortador tomates

| art.     | cm.      | Kg. |
|----------|----------|-----|
| 49837-05 | 30x14x18 | 2   |

Slice thickness 5,5 mm. – Spessore taglio 5,5 mm.



**Mozzarella/tomato cutter**

Affetta mozzarella/pomodori  
Mozzarella-/Tomatenschneider  
Coupe-mozzarella/tomates  
Cortador mozzarella/tomates

| art.     | cm.      | Kg. |
|----------|----------|-----|
| 49820-05 | 48x20x32 | 7,1 |

Also suitable for cutting lemons, oranges or kiwis, etc. Slice thickness 5,5 mm.  
Adatto anche per tagliare limoni, arance o kiwi, ecc. Spessore fetta 5,5 mm.





SS

**Fruit cutter**

Trancia spicchi  
Früchteschneider  
Coupe-fruits  
Cortador tomates

| art.     | cm.      | Kg. |
|----------|----------|-----|
| 49838-08 | 38x26x58 | 3,3 |

**8 wedges, for vegetables and fruits without stone. – 8 spicchi, per ortaggi e frutta senza nocciolo.**



**Apple corer/wedger set of blades**

Set lame levatorsolo e trancia spicchi  
Apfelentkerner-/Schneidmesser  
Lames évideur/coupe-pommes  
Saca corazón y cortador para manzanas

| art.     |
|----------|
| 49838-98 |



SS

**Cube cutter**

Taglia cubi  
Würfel-Schneidgerät  
Coupe-cubes  
Cortador en dados

| art.     | cm.        | Kg. |
|----------|------------|-----|
| 49821-08 | 35,5x26x66 | 4   |

**Dice thickness 8 mm. – Spessore taglio 8 mm.**



**Epoxy peeler on stand**

Pela carote/verdure supporto epossidico  
Gemüeschäler, Epoxidfuß  
Éplucheur sur pied epoxy  
Pelador sobre pie epoxy

| art.     | cm.        | Kg. |
|----------|------------|-----|
| 49819-00 | 21,5x14x51 | 1,8 |

**Equipped with ø 4,5 cm. – Dotazione ø 4,5 cm.**



**Additional peeling heads**

Accessori opzionali per pela verdure  
Schälkopf-Zusatzteile  
Têtes supplémentaires pour éplucheur  
Cabezas suplementarios para pelador

| art.     | Ø cm. |
|----------|-------|
| 49819-01 | 4,5   |
| 49819-02 | 6,0   |



SS

**Vegetable cutter**

Taglia verdure  
Gemüeschneider  
Machine à tourner les légumes  
Cortador de verduras

| art.     | cm.        | Kg. |
|----------|------------|-----|
| 49842-00 | 21x17,5x19 | 3,2 |

**To make chateau potatoes, cocottes and fondants lenght from 4 to 8 cm. 3 position adjustable blade. – Per patate chateau, cocotte e fondenti di lunghezza da 4 a 8 cm. Lama con 3 regolazioni di taglio.**



SS

**Pineapple-peeler/corer**

Pela/svuota ananas  
Ananasschälmaschine  
Epluche-ananas  
Pelador de piña

| art.     | cm.      | Kg. |
|----------|----------|-----|
| 49818-00 | 45x39x72 | 18  |

**Blade and pusher ø 89 mm.  
Lama e pressatore ø 89 mm.**



**Additional pushers and blades**

Pressatori e lame opzionali  
Zusätzliche Presse und Messer  
Poussoirs et couteaux supplémentaires  
Empujador y cuchilla suplementarios

| art.     | Ø cm. |
|----------|-------|
| 49818-AC | 7,4   |
| 49818-AD | 7,4   |
| 49818-AE | 10,2  |
| 49818-AF | 10,2  |

**AC, AE: blade - AD, AF: pusher.  
AC, AE: lama - AD, AF: pressatore.**



SS

**Pineapple slicer**  
 Taglia ananas  
 Ananasteiler  
 Coupe-ananas en rondelle  
 Cortador de piña en rondajas

art. Ø cm. l. cm.  
 48218-00 2,5 24



SS

**Pineapple coring tool**  
 Svuota ananas  
 Ananasausstecher  
 Vide ananas  
 Saca corazón de piña

art. Ø cm. l. cm.  
 48280-10 2,5 24



**Electric peeler**  
 Pelatrice elettrica  
 Elektr. Schälmachine  
 Eplucheur électrique  
 Pelador eléctrico

art. cm. Kg.  
 49750-00 25x16x21,5 2



**Professional apple peeler**  
 Pela mele professionale  
 Profi-Apfelschäler  
 Pèle-pommes, professionnel  
 Pelador de manzanas, profesional

art. cm. Kg.  
 49834-00 32x14x10 1,9



**Orange peeler with screw**  
 Pela arance con morsetto  
 Orangenschäler, Tischklemme  
 Pèle-orange, socle serre-joint  
 Pelador de naranjas, fijación brida

art. cm.  
 49817-00 30x10x15



**Apple peeler with screw**  
 Pela mele con morsetto  
 Apfelschäler, Tischklemme  
 Pèle-pommes, socle serre-joint  
 Pelador de manzanas, fijación brida

art. cm.  
 49835-00 30x10x17



**Apple peeler, vacuum-power base**  
 Pela mele con ventosa  
 Apfelschäler, Vakuum-Fuss  
 Pèle-pommes, socle vacuum  
 Pelador de manzanas, fijación ventosa

art. cm.  
 49836-00 30x10x13



SS

**Potato twist cutter**  
 Tagliaverdure ghirlanda  
 Kartoffeln-Spiralschneider  
 Machine à brochette  
 Coratador de verduras

art. cm. Kg.  
 49843-00 33x13x45 3,4

Slice thickness 2,5 mm. – Spessore taglio 2,5 mm.



SS

**Apple corer/wedger**  
 Trancia spicchi per mela  
 Apfelenkerner-/Schneider  
 Lames évideur/coupe-pommes  
 Cortador y descorazonador manzanas

art. Ø cm.  
 48289-10 10



SS

**Egg wedger**  
 Taglia uova  
 Eierteiler  
 Tranche-oeufs  
 Cortahuevos

art. Ø cm. l. cm.  
 42597-00 6,5 21



SS

**Egg knocker**

Apriuovo  
Eierköpfer  
Toque oeuf  
Abridor de huevos

art. Ø cm. l. cm.  
42595-01 3,2 11



**Egg slicer, aluminum**

Taglia uova, alluminio  
Eierteiler, Aluminium  
Tranche-oeufs rondelle, aluminium  
Cortahuevos guitarra, aluminio

art. cm.  
42588-01 13,5x8x4,5



**Egg slicer duo**

Taglia uova doppio  
Eierteiler 2 in 1  
Tranche-oeufs 2 emplacements  
Cortahuevos doble

art. cm.  
42588-00 21x8x4,5



**Egg container**

Contentitore per uova  
Eier-Behälter  
Porte-oeufs  
Contenedor para huevos

art. cm.  
47093-24 30x21,5x6,5



AY

**Egg container**

Contentitore per uova  
Eier-Behälter  
Porte-oeufs  
Contenedor para huevos

art. cm.  
44947-07 15x20x5



SS

**Egg rings 2 pcs**

Anelli per uova 2 pz  
Eierringe, 2 Stk  
Ronds à oeufs, 2 pcs  
Anillos para huevos, 2 pz

art. Ø cm. h.  
42596-02 8 1,5



**Egg ring, non stick**

Anello per uova, antiaderente  
Eierring, beschichtet  
Rond à oeufs, anti-adhésif  
Anillo para huevos, antiadherente

art. Ø cm. h.  
42650-10 10 1,5



**Egg ring, non stick**

Anello per uova, antiaderente  
Eierring, beschichtet  
Rond à oeufs, anti-adhésif  
Anillo para huevos, antiadherente

art. Ø cm. h.  
42650-11 11 1,5



NEW

**Artichoke corer**

Svuota carciofi  
Artischocken Entkerner  
Etrogneur à artichauts  
Saca corazon para alcachofas

art. Ø cm. h.  
48288-02 8 8



NEW

**Brussel sprout cutter**

Taglia cavolini di Bruxelles  
Rosenkohl-Schneider  
Coupe-choux de Bruxelles  
Cortador de coles de Bruselas

art. cm.  
48288-03 8x8x10

**Top-rack dishwasher-safe. ABS body and scoop, PP cover, stainless steel blade.**

Lavabile in lavastoviglie nel cestello superiore. Corpo e paletta in ABS, coperchio in PP, lama inox.

**Dishwasher safe. SAN transparent body, ABS frame, PP base, stainless steel blade.**

Lavabile in lavastoviglie. Corpo trasparente SAN, telaio in ABS, base in PP, lama inox.



SS

**Mushroom cutter**

Taglia funghi  
Pilze-Teiler  
Tranche-champignons  
Cortador de hongas

| art.     | Ø cm. | l. cm. |
|----------|-------|--------|
| 42598-00 | 7,6   | 20,7   |



SS

**Avocado peeler and slicer**

Pela/taglia avocado  
Avocadoschäler-/Teiler  
Pèle et tranche avocat  
Pelador y cortador de aguacete

| art.     | l. cm. |
|----------|--------|
| 48286-62 | 18,5   |



SS

**Large vegetable slicer**

Pelaverdure  
Gemüeschäler  
Eplucheur à légumes  
Pelador de verduras

| art.     | cm.   |
|----------|-------|
| 48286-64 | 22x10 |



**Potato peeler**

Pelapatate  
Sparschäler  
Eplucheur  
Pelador de patatas

| art.     | cm. |
|----------|-----|
| 42589-00 | 5x4 |



SS

**Potato ricer with 3 discs**

Schiacciapatate, 3 griglie  
Kartoffelpresse, 3 Roste  
Presse-purée, 3 grilles  
Pasapurés, 3 discos

| art.     | Ø cm. | cm.      |
|----------|-------|----------|
| 42566-03 | 8,5   | 30x10x11 |

Discs/Dischi: ø 2,4 - 4,4 - 6,5 mm.



SS

**French fry cutter**

Taglia patate  
Kartoffelschneidergerät  
Coupe-frites  
Cortador de patatas fritas

| art.     | cm.      | Kg. |
|----------|----------|-----|
| 49832-10 | 24x44x34 | 11  |

Cutting knife/Quadro di taglio: 10 mm.



NEW

SS

**French fry cutter**

Taglia patate  
Kartoffelschneidergerät  
Coupe-frites  
Cortador de patatas fritas

| art.     | cm.        |
|----------|------------|
| 49831-10 | 28x11x16,5 |

Functional and solid. With suction base. Space-saving size. Accurate cutting 10 mm. Easy to clean – Funzionale e solido. Base con ventose. Salvaspazio. Taglio preciso, 10 mm. Facile da pulire.



SS

**French fry cutter**

Taglia patate  
Kartoffelschneidergerät  
Coupe-frites  
Cortador de patatas fritas

| art.     | cm.       | Kg. |
|----------|-----------|-----|
| 49832-02 | 26x9x12,5 | 1,2 |

Cutting knives/Quadri di taglio: 9x9 - 12x12 mm.



**Herb scissors, 5 blades**

Forbice per erbe, 5 lame  
Kräuterschere, 5 Klängen  
Ciseaux à herbes, 5 lames  
Tijeras hierbas, 5 cuchillas

| art.     | l. cm. |
|----------|--------|
| 18277-00 | 10     |



**Cheese rotary grater**

Grattugia formaggio rotatoria  
Drehe-Käse-Raffel  
Frisette à fromage  
Ralladora giratoria para queso

| art.     | Ø cm. | h. |
|----------|-------|----|
| 48281-22 | 22    | 16 |

**Wood base. – Base legno.**



**Rotary grater cover**

Cloche per grattugia rotatoria  
Käse-Raffel-Haube  
Cloche à frisette  
Tapa para ralladora

| art.     | Ø cm. | h. |
|----------|-------|----|
| 48281-23 | 15,5  | 11 |



**Tortillas wedge**

Taglia tortillas  
Tortillasteiler  
Coupe-tortillas  
Corta tortillas

| art.     | Ø cm. |
|----------|-------|
| 42599-06 | 25    |
| 42599-08 | 25    |

**Wedges/Spicchi: 6 - 8.**

SS



**Grater, automatic**

Grattugia automatica  
Reibe, automatisch  
Râpe automatique  
Rallador automático

| art.     | cm.    |
|----------|--------|
| 48295-10 | 20x5,4 |

**Hermetic container, removable, with lid, 2 blades.  
Ideal for cheese, nuts, chocolate. etc.**  
Recipiente ermetico, removibile, con cop., 2 lame.  
Ideale per formaggio, noci, cioccolato, ecc.



**Cheese wire cutter**

Lira per formaggi  
Käse Drahtschneider  
Lyre à fromage  
Lira para quesos

| art.     | cm.       |
|----------|-----------|
| 48282-21 | 20,5x26,7 |

SS



**Garlic press, chromed**

Spremiaglio, cromato  
Knoblauchpresse, verchromt  
Presse-ail, chromé  
Prensador de ajo, cromado

| art.     | Ø cm.   | l. cm. |
|----------|---------|--------|
| 42565-00 | 3,5x2,5 | 14,5   |



**Olive seed remover, chromed**

Snocciolatore, cromato  
Olivenentsteiner, verchromt  
Dénoyoteur, chromé  
Quita pepa/hueso, cromado

| art.     | l. cm. |
|----------|--------|
| 42563-00 | 17     |





**Cherry core stripper**  
 Snocciolatore  
 Kirschenentsteiner  
 Dénoyauteur de cerises  
 Quita pepa/hueso

| art.     | Ø cm. | h. |
|----------|-------|----|
| 42563-44 | 10    | 34 |



SS

**Mandoline**  
 Mandolino  
 Gemüsehobel Mandoline  
 Mandoline  
 Mandolina

| art.     | cm.         | Kg. |
|----------|-------------|-----|
| 49829-11 | 39x12,5x5,5 | 1,7 |

**Equipped with 7 interchangeable blades.**  
 Dotato di 7 lame intercambiabili.



SS

**Slicer Mandoline, Grand Gourmet**  
 Mandolino Grand Gourmet  
 Gemüsehobel Grand Gourmet  
 Mandoline Grand Gourmet  
 Mandolina Grand Gourmet

| art.     | cm.      | Kg. |
|----------|----------|-----|
| 49830-60 | 40x12x28 | 1,6 |

**38 blades, 10 mm. – 38 lame, 10 mm.**



NEW

SS

**Mandoline**  
 Mandolino  
 Gemüsehobel Mandoline  
 Mandoline  
 Mandolina

| art.     | cm.       | Kg. |
|----------|-----------|-----|
| 49755-10 | 38x11x3,5 | 1   |

**Non-slip base, ergonomic handle. Adjustable and precise cutting thickness.**  
 Base antiscivolo, impugnatura ergonomica.  
 Spessore di taglio regolabile e preciso.

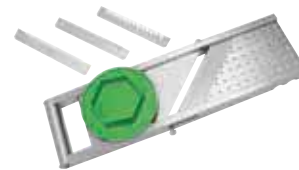

SS

**Mandoline**  
 Mandolino  
 Gemüsehobel Mandoline  
 Mandoline  
 Mandolina

| art.     | cm.         | Kg. |
|----------|-------------|-----|
| 49752-00 | 33,5x11x2,3 | 0,6 |

**3 interchangeable blades of 2-3-6 mm.**  
 3 lame intercambiabili da 2-3-6 mm.



ABS

**Japanese Mandoline slicer**  
 Mandolino giapponese  
 Japanese Gemüsehobel  
 Mandoline japonaise  
 Mandolina japonés

| art.     | cm.       | Kg. |
|----------|-----------|-----|
| 49753-06 | 11x31,5x3 | 0,3 |
| 49753-09 | 15x35x3,3 | 0,5 |

**1 plain blade and 3 blades of 1-2-3 mm.**  
 1 lama liscia e 3 lame da 1-2-3 mm.



SS

**Cutter/corer**  
 Intaglia verdure  
 Ausstechforme  
 Découpoir  
 Sacabocados

| art.     | cm.       |
|----------|-----------|
| 48286-70 | 3,7x8,5x9 |

**Cutting ø 3,4 cm. – Taglio ø 3,4 cm.**



SS

**Cutter turn'up**  
 Tagliaverdura turn'up  
 Ausstechforme Turn'Up  
 Découpoir pour fonds à garnir  
 Descorazonador-vaciador turn'up

| art.     | Ø cm. | h.   |
|----------|-------|------|
| 48285-04 | 4     | 14,5 |
| 48285-05 | 5     | 14,5 |



**NEW**  
**ABS**  
**SS**

**Spiral vegetable slicer 7-blades 8-cuts**

Taglia verdure 7-lame 8-tagli  
Gemüseschneider 7-Messer 8-Schnitte  
Coupe légumes 7-lames 8-coupes  
Cortador de verduras 7-cuchillas 8-cortes

art. cm.  
49827-77 14,3x23,8x14,3

**The 8-cut collapsible spiralizer can be used with a wide range of fruits and vegetables. Blades included: 4 mm straight blade, 10 mm chipper blade, 1,5 mm wavy blade, 2,5 mm straight blade, 2 mm Angel hair blade, 3 mm shredder blade, 6 mm chipper blade. Bpa-free. Patented. All parts are top-rack dishwasher-safe.** – Il taglia verdure a 8 tagli può essere utilizzato con una vasta gamma di frutta e verdura. Lame incluse: 2 lame lisce mm 2,5 e 4, lama ondulata da 1,5 mm, lama capelli d'angelo da 2 mm, 3 lame taglio spaghetti mm. 3, 6 e 10. Senza BPA. Brevettato. Tutte le parti sono lavabili in lavastoviglie nel cestello superiore.



**ABS**  
**SS**

**Spiral vegetable slicer 3-blade**

Taglia verdure 3-lame  
Gemüseschneider 3-Messer  
Coupe légumes 3 lames  
Cortador de verduras 3 cuchillas

art. cm.  
49827-99 30x14x22

**3 interchangeable s/s blades (3 - 6 mm. and 1 straight blade for ribbon cuts). Ideal for julienne cuts, chips, spiral shapes, rings and plain slices of vegetables and fruits.** – 3 lame inox intercambiabili (3 - 6 mm. e 1 lama dritta per taglio a nastro). Ideale per julienne, chips, riccioli, anelli e fette sottili di verdura e frutta.



**Spiral vegetable slicer, plastic**

Taglia verdure, plastica  
Gemüseschneider, Kunststoff  
Coupe légumes, plastique  
Cortador de verduras, plástico

art. Ø cm. h.  
49825-05 8 15



**SS**

**Strip slicer**

Taglia verdure  
Gemüseschneider  
Coupe-lanières  
Cortador de verduras japonés

art. cm. Kg.  
49823-00 20x20x25 1,9

**Width of cut 15 cm. Max vegetables length 11 cm. and ø 17 cm.** – Larghezza taglio 15 cm. Lunghezza max verdura 11 cm. e ø 17 cm.



**ABS**

**Strip slicer**

Taglia verdure  
Gemüseschneider  
Coupe lanière  
Cortador de verduras

art. cm.  
49823-89 28x25x16,5

**Width of cut 13 cm. Thickness 0,5 mm.** – Larghezza taglio 13 cm. Spessore 0,5 mm.



ABS

**Strip & spaghetti slicer**

Taglia verdure  
Gemüseschneider  
Coupe lanière et spaghetti  
Cortador de verduras japonés

art. cm.  
49823-99 28x25x16,5

**Width of cut 13 cm. 2 blades 130x0,5 - 1x1,2 mm.**  
Larghezza taglio 13 cm. 2 lame 130x0,5 - 1x1,2 mm.



ABS  
SS

**Vegetable cutter LE ROUET GOURMET**

Taglia verdure  
Gemüseschneider  
Coupe légumes  
Cortador de verduras

art. cm. Kg.  
49827-03 13,5x36x24,3 2,4

**Cutting blocks 1-2-4 mm. Cutting thickness blade guirlandes 1>4 mm. - Pettini taglio 1-2-4 mm. Spessore taglio lama guirlandes 1>4 mm.**



SS

**Thai knife**

Stiletto thailandese  
Thai-Messer  
Stylet thai  
Cuchillo thai

art. l. cm.  
48286-08 16



SS

**Decoration tools 18 pcs**

Attrezzi decoro, 18 pz  
Dekoriersatz, 18-Tlg.  
Outils de décor 18 pcs  
Herramientas decoración 18 pz

art.  
48286-03



SS

**Decoration tools 22 pcs**

Attrezzi decoro, 22 pezzi  
Dekoriersatz, 22-Tlg.  
Outils de décor 22 pcs  
Herramientas decoración 22 pz

art. cm.  
48286-13 38,5x29



**Ice knife**

Coltello ghiaccio  
Eis-Messer  
Couteau à glace  
Cuchillo para hielo

art. l. cm. Kg.  
47885-01 25 0,12



**Chisel V shape**

Scalpello ghiaccio a V  
Eismeissel  
Ciseau à glace  
Cinsel a V para hielo

art. l. cm. Kg.  
47885-02 31,5 0,28



**Chisel flat medium**

Scalpello ghiaccio 3 lati smussati  
Eismeissel  
Ciseau à glace  
Cinsel para hielo

art. l. cm. Kg.  
47885-03 50 0,45



**Chisel flat big**

Scalpello ghiaccio 1 lato smussato  
Eismeissel  
Ciseau à glace  
Cinsel para hielo

art. l. cm. Kg.  
47885-04 74,5 0,78



**Ice chisel set 4 pcs**

Scalpelli ghiaccio 4 pz  
Eismeissel 4 Stk  
Ciseaux à glace 4 pcs  
Cinseles para hielo 4 piezas

art.  
47885-05



**Butter churn**

Mantecatore per burro  
Butterfaß  
Baratte à beurre  
Mantequera

art. cm. lt.  
48294-01 11,5x11,5x40 1,6



**Butter mold**

Stampo per burro  
Butterform  
Moule à beurre  
Molde para mantequilla

art. cm. gr.  
48294-02 12,2x6,6x4,3 80



**Butter mold**

Stampo per burro  
Butterform  
Moule à beurre  
Molde para mantequilla

art. cm. gr.  
48294-03 15,8x9x5 125

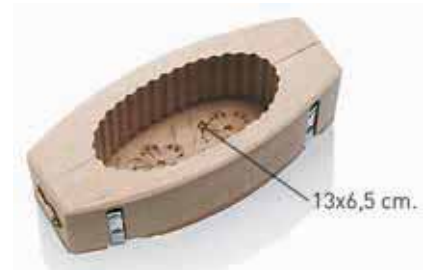

**Butter mold**

Stampo per burro  
Butterform  
Moule à beurre  
Molde para mantequilla

art. cm. gr.  
48294-04 21x9,4x5,8 250



**Grater, non-slip handle**

Grattugia, manico antiscivolo  
Reibe, Rutschfestes Griff  
Râpe queue antidérapant  
Rallador mango antiderrapante

art. cm. l. cm.  
42560-01 4x22 38,5



**Grater, non-slip handle**

Grattugia, manico antiscivolo  
Reibe, Rutschfestes Griff  
Râpe queue antidérapant  
Rallador mango antiderrapante

art. cm. l. cm.  
42560-02 4x22 38,5



**Grater, non-slip handle**

Grattugia, manico antiscivolo  
Reibe, Rutschfestes Griff  
Râpe queue antidérapant  
Rallador mango antiderrapante

art. cm. l. cm.  
42560-03 4x22 38,5



**Grater, non-slip handle**  
 Grattugia, manico antiscivolo  
 Reibe, Rutschfestes Griff  
 Râpe queue antidérapant  
 Rallador mango antiderrapante

art. cm. l. cm.  
 42560-04 7,7x13,3 30



**Grater, non-slip handle**  
 Grattugia, manico antiscivolo  
 Reibe, Rutschfestes Griff  
 Râpe queue antidérapant  
 Rallador mango antiderrapante

art. cm. l. cm.  
 42560-05 7,7x13,3 30



**Grater, non-slip handle**  
 Grattugia, manico antiscivolo  
 Reibe, Rutschfestes Griff  
 Râpe queue antidérapant  
 Rallador mango antiderrapante

art. cm. l. cm.  
 42560-06 7,7x13,3 30



**Grater, non-slip handle**  
 Grattugia, manico antiscivolo  
 Reibe, Rutschfestes Griff  
 Râpe queue antidérapant  
 Rallador mango antiderrapante

art. cm. l. cm.  
 42560-07 7,7x13,3 30



**Grater, non-slip handle**  
 Grattugia, manico antiscivolo  
 Reibe, Rutschfestes Griff  
 Râpe queue antidérapant  
 Rallador mango antiderrapante

art. cm. l. cm.  
 42560-08 7,7x13,3 30



**Grater, non-slip handle**  
 Grattugia, manico antiscivolo  
 Reibe, Rutschfestes Griff  
 Râpe queue antidérapant  
 Rallador mango antiderrapante

art. cm. l. cm.  
 42560-09 7,7x13,3 30



**Spätzle sieve**  
 Grattugia per spätzle  
 Spätzle-Reibe  
 Grille à spätzle  
 Rallador para spätzle

art. cm.  
 49844-01 31x10,5x6



**Nutmeg grater**  
 Grattugia noce moscata  
 Muskatreibe  
 Râpe à muscade  
 Rallador nuez moscada

art. cm.  
 42556-00 4,5x14



**4-ways grater**  
 Grattugia 4 tagli  
 Vierkantreibe  
 Râpe 4 facés  
 Rallador 4 caras

art. cm.  
 42569-04 10x8x23



PP

**Dumplin maker**

Stampo panzerotti  
Knödel-Form  
Moule à chaussons  
Molde para empanadillas

art. mm.  
49843-05 62, 82, 104, 177



**Safety can opener**

Apriscatole sicuro  
Sicherheitsdosenöffner  
Ouvre-boîte de sûreté  
Abrelatas de seguridad

art. cm.  
48222-01 12,5x8



**Universal can opener**

Apriscatole universale, nichelato  
Universal-Dosenöffner  
Ouvre-boîte, universel  
Abrelatas universal

art. cm.  
48220-00 8x7



**Can opener, PP handle**

Apriscatole, impugnatura PP  
Dosenöffner, Griffe aus PP  
Ouvre-boîte, poignées PP  
Abrelatas, mango PP

art. l. cm.  
48280-03 21



SS

**Electric sieve**

Passaverdura elettrico  
Elektropassiergerät  
Moulin électrique  
Molino eléctrico

art. Ø cm. h. kg./H Kg.  
49879-37 37 108 300 23,5

Equipped with 3 mm disc. – Griglia 3 mm.



**Sieve on tripod, tinned**

Passaverdura stagnato con supporto  
Passiergerät, verzinkt, mit Träger  
Moulin étamé sur pied  
Molino estañado sobre pie

art. Ø cm. h. Kg.  
42577-39 39 80 14

Equipped with 3 mm disc. – Griglia 3 mm.



**Tomato juicer sieve**

Passapomodori, professionale  
Profi-Tomatenpassiergerät  
Moulin à tomates professionnel  
Molino para tomates, profesional

art. Ø cm. h.  
42576-00 21 50

Equipped with 1 mm disc. – Griglia 1 mm.



SS

**Herb mill**

Macinaerbe  
Kräutermühle  
Moulin fines herbes  
Molino de hierbas finas

art. cm.  
42558-00 7x22



SS

**Sieve, 3 discs**

Passaverdura, 3 griglie  
 Passiergerät, 3 Roste  
 Moulin inox, 3 grilles  
 Molino inox, 3 rejillas

| art.     | Ø cm. | h.   | Kg.  |
|----------|-------|------|------|
| 42571-20 | 19    | 16,5 | 0,46 |
| 42572-24 | 24    | 16,5 | 0,82 |

**Discs: 1,5 - 2 - 4 mm. – Griglie: 1,5 - 2 - 4 mm.**



SS

**Sieve, 3 discs**

Passaverdura, 3 griglie  
 Passiergerät, 3 Roste  
 Moulin inox, 3 grilles  
 Molino inox, 3 rejillas

| art.     | Ø cm. | h. | Kg. |
|----------|-------|----|-----|
| 42570-32 | 31    | 25 | 1,4 |

**Discs: 1,5 - 2,5 - 4 mm. – Griglie: 1,5 - 2,5 - 4 mm.**



**Sieve, tinned, 3 discs**

Passaverdura stagnato, 3 griglie  
 Passiergerät, verzinkt, 3 Roste  
 Moulin étamé, 3 grilles  
 Molino estañado, 3 rejillas

| art.     | Ø cm. | h. | Kg. |
|----------|-------|----|-----|
| 42573-31 | 31    | 25 | 1,4 |

**Discs: 1,5 - 2,5 - 4 mm. – Griglie: 1,5 - 2,5 - 4 mm.**



SS

**Sieve, 1 disc**

Passaverdura, 1 griglia  
 Passiergerät, 1 Rost  
 Moulin inox, 1 grille  
 Molino inox, 1 rejilla

| art.     | Ø cm. | h. | Kg. |
|----------|-------|----|-----|
| 42574-37 | 37    | 32 | 3,5 |

**Equipped with 3 mm disc. – Griglia 3 mm.**



**Sieve, tinned, 1 disc**

Passaverdura stagnato, 1 griglia  
 Passiergerät, verzinkt, 1 Rost  
 Moulin étamé, 1 grille  
 Molino estañado, 1 rejilla

| art.     | Ø cm. | h. | Kg. |
|----------|-------|----|-----|
| 42575-37 | 37    | 32 | 3,5 |

**Equipped with 3 mm disc. – Griglia 3 mm.**



42570 - 42573

42574 - 42575  
 42577 - 49879



NEW

SS

**Bottles and cans press**

Pressa bottiglie e lattine  
 Flaschen und Dosen Presse  
 Presse bouteilles et boîtes  
 Prensa botellas y latas

| art.     | cm.        |
|----------|------------|
| 49815-00 | 13,5x12x50 |

**To crush cans and plastic bottles. All cans. Bottles up to 2.5 l. – Per tutti tipi di lattine e per bottiglie di plastica fino a 2,5 l.**





**NEW**

**SS**

**Table top can opener**  
Apriscatole da banco  
Tisch-Dosenöffner  
Ouvre-boîte  
Abrelatas

art. cm. Kg.  
49867-01 28x12,2x77,5 5

**With screw base. Patented opening system. Opens round cans any sizes securely from 8 to 50 cm height), leaves smooth and not sharp edges. The cap can be reused. Dishwasher safe.**  
Base da avvitare. Sistema di apertura brevettato. Per scatole rotonde di tutte le dimensioni (h da 8 a 50 cm). Rifilo netto dei bordi esterni. Nessun rischio di taglio. Possibilità di riutilizzare il coperchio dalla scatola. Lavabile in lavastoviglie.



**NEW**

**SS**

**Table top can opener**  
Apriscatole da banco  
Tisch-Dosenöffner  
Ouvre-boîte  
Abrelatas

art. cm. Kg.  
49867-02 28x12,2x77,5 5

**With clamp base. Patented opening system. Opens round cans any sizes securely from 8 to 50 cm height), leaves smooth and not sharp edges. The cap can be reused. Dishwasher safe.**  
Base con morsetto. Sistema di apertura brevettato. Per scatole rotonde di tutte le dimensioni (h da 8 a 50 cm). Rifilo netto dei bordi esterni. Nessun rischio di taglio. Possibilità di riutilizzare il coperchio dalla scatola. Lavabile in lavastoviglie.



**Table top can opener**  
Apriscatole da banco  
Tisch-Dosenöffner  
Ouvre-boîte  
Abrelatas

art. l. cm.  
19810-00 56

**Can size up to height 45 cm. Clamp base and bar in die-cast aluminum, steel head. Table fixing either with screws or clamp. – Altezza scatola fino a 45 cm. Corpo in alluminio pressofuso, testa in acciaio, fissaggio a viti o morsetto.**



**Table top can opener, steel**  
Apriscatole da banco, acciaio  
Tisch-Dosenöffner, Stahl  
Ouvre-boîte, acier  
Abrelatas, acero

art. l. cm.  
49811-00 40

**Can size up to height 30 cm. Table fixing with clamp base. – Altezza scatola fino a 30 cm. Fissaggio a morsetto.**



**SS**

**Table top can opener**  
Apriscatole da banco  
Tisch-Dosenöffner  
Ouvre-boîte  
Abrelatas

art. l. cm.  
49812-00 55

**Can size up to height 40 cm. Table fixing with clamp base. – Altezza scatola fino a 40 cm. Fissaggio a morsetto.**



**SS**

**Electric can opener**  
Apriscatole elettrico  
Elektrodosenöffner  
Ouvre-boîte électrique  
Abrelatas eléctrico

art. cm. Kg.  
49814-00 44x25x75 13

**Dual speed motor. Opens all can shapes from 50 to 270 mm height. – Motore a 2 velocità. Per tutti i formati di scatola da 50 a 270 mm di altezza.**





# THERMOMETERS TERMOMETRI

KITCHEN UTENSILS  
UTENSILI DA CUCINA





SS

**Meat roasting thermometer**

Termometro arrosti  
Braten-Thermometer  
Thermomètre à rôtir  
Termómetro asado

art. Ø cm. scala range  
49705-00 4,5 1°C 0+120°C

**Penetration probe 13 cm. – Sonda l. 13 cm.**



SS

**Meat roasting thermometer**

Termometro arrosti  
Braten-Thermometer  
Thermomètre à rôtir  
Termómetro asado

art. Ø cm. range  
19705-00 5 +54+88°C



SS

**Cooking & frying thermometer**

Termometro fritti  
Back-Thermometer  
Thermomètre à friture  
Termómetro frituras

art. Ø cm. scala range  
19706-00 5 10°C +38+205°C



NEW

SS

**Milk frothing thermometers, 3 pcs**

Termometri latte/barista, 3 pz  
Mich-Thermometer, 3 Stk  
Thermomètres à lait, 3 pièces  
Termómetros leche, 3 pz

art. Ø cm. scala range  
49709-03 4,5 1°C -10+110°C

**Red, green and blue, to easily identify different types of milk used, to avoid cross-contamination. Stem 175 mm. – Rosso, verde e blu, per identificare facilmente i diversi tipi di latte utilizzati, per evitare la contaminazione incrociata. Stelo 175 mm.**



**Sugar thermometer**

Termometro per zucchero  
Zuckerthermometer  
Thermomètre à sucre  
Termómetro azúcar

art. l. cm. scala range  
47843-00 30 1°C +80+200°C

**Stainless steel housing. – Guaina inox.**



NEW

**Sugar/jam thermometer**

Termometro per zucchero/marmellata  
Zucker- und Marmeladenthermometer  
Thermomètre à sucre et confiture  
Termómetro azúcar y mermelada

art. scala range  
47843-05 2°C +40+200°C

**Brass. – Ottone. Dim. 4,7x20 cm.**



**Baker's thermometer**

Termometro per panettiere  
Bäckerthermometer  
Thermomètre boulanger  
Termómetro panadero

art. l. cm. scala range  
49712-00 30 1°C -10+60°C

**Plastic housing. – Guaina plastica.**



SS

**Oven thermometer**

Termometro per forno  
Ofenthermometer  
Thermomètre à four  
Termómetro horno

art. Ø cm. scala range  
19709-00 7 10°C +38+316°C



ABS

**Fridge/freezer thermometer**

Termometro frigo/freezer  
Kühlschrank-Thermometer  
Thermomètre à réfrigérateur  
Termómetro congelador

| art.     | Ø cm. | scala | range    |
|----------|-------|-------|----------|
| 49885-02 | 7     | 1°C   | -50+50°C |



SS

**Fridge/freezer thermometer**

Termometro frigo/freezer  
Kühlschrank-Thermometer  
Thermomètre à réfrigérateur  
Termómetro congelador

| art.     | Ø cm. | scala | range    |
|----------|-------|-------|----------|
| 19702-00 | 6     | 1°C   | -29+27°C |



ABS

**Digital thermometer**

Termometro digitale  
Digitalthermometer  
Thermomètre digitale  
Termómetro digital

| art.     | scala | range    |
|----------|-------|----------|
| 49887-00 | 0,1°C | -50+70°C |

Dim. cm. 1,5x5x7



NEW

ABS

**Digital fridge thermometer**

Termometro digitale per frigorifero  
Kühlschrank-Digitalthermometer  
Thermomètre digitale à réfrigérateur  
Termómetro digital para refrigerador

| art.     | scala | range       |
|----------|-------|-------------|
| 49887-02 | 0,1°C | -9,9+49,9°C |

**Dim. Cm. 2,6x4,5x7,3. Water resistant IP65. Features a food safety zone icon in the display that indicates when the temperature is outside the range of 0 to 5°C. – Resistente all'acqua IP65. Un'icona indica sul display quando la temperatura è al di fuori dell'intervallo da 0 a 5°C.**



**Room/wall thermometer**

Termometro da muro  
Wandthermometer  
Thermomètre à mur  
Termómetro de pared

| art.     | scala | range    |
|----------|-------|----------|
| 49702-00 | 1°C   | -30+50°C |

Dim. cm. 20,5x4. Without mercury. Senza mercurio.



**Pocket thermometer**

Termometro da tasca  
Taschenthermometer  
Thermomètre à poche  
Termómetro digital

| art.     | l. cm. | scala | range     |
|----------|--------|-------|-----------|
| 19701-00 | 15     | 0,1°C | -50+150°C |



**Digital thermometer**

Termometro digitale  
Digitalthermometer  
Thermomètre digitale  
Termómetro digital

| art.     | scala | range     |
|----------|-------|-----------|
| 49710-00 | 1°C   | -50+300°C |

Probe 135 mm. ø 2,5 mm.  
Sonda 135 mm. ø 2,5 mm.



**Pocket thermometer**

Termometro da tasca  
Taschenthermometer  
Thermomètre à poche  
Termómetro digital

| art.     | scala | range     |
|----------|-------|-----------|
| 49701-00 | 0,1°C | -50+200°C |

Probe 125 mm. ø 3,5 mm.  
Sonda 125 mm. ø 3,5 mm.



**Digital thermometer**

Termometro digitale  
Elektronisches Thermometer  
Thermomètre digital  
Termómetro digital

art. scala range  
49715-00 0,1°C -50+300°C

**Probe 125 mm. ø 3,5 mm.**  
Sonda 125 mm. ø 3,5 mm.



**Digital thermometer**

Termometro digitale  
Elektronisches Thermometer  
Thermomètre digital  
Termómetro digital

art. scala range  
49716-00 0,1°C -50+300°C

**Dim. cm. 1,9x7x15,2. Countdown/up 99h-59m.**



**Digital thermometer**

Termometro digitale  
Elektronisches Thermometer  
Thermomètre digital  
Termómetro digital

art. scala range  
49883-00 0,1°C -50+300°C

**Dim. cm. 13x5,5x2,5. Probe 13 cm. ABS case incl. Biomaster AT.** – Involucro ABS con Biomaster. Sonda 13 cm.



**Multi-function thermometer**

Termometro multifunzione  
Multifunktions-Thermometer  
Thermomètre multifonction  
Termómetro multifunción

art. scala range  
49988-00 0,1°C -19,9+149,9°C

**Dim. cm. 2,5x7,3x12,3. Probe 125 mm. ø 3,5.**  
**Housing & probe handle incl. Biomaster AT.**  
Involucro e manico sonda con Biomaster. Sonda 125 mm. ø 3,5.



**Infrared thermometer**

Termometro a infrarossi  
Infrarot-Thermometer  
Thermomètre infrarouge  
Termómetro infrarrojo

art. scala range  
49986-00 0,1°C -49,9+349,9°C

**Dim. cm. 2,5x5,2x10**



**Infrared thermometer**

Termometro a infrarossi  
Infrarot-Thermometer  
Thermomètre infrarouge  
Termómetro infrarrojo

art. scala  
49884-08 0,1/1°C

**Dim. cm. 4x6,6x15,5. Range infrared-Infrarossi: -60 to 500°C – Range probe-Sonda: -64 to 1370°C.**



**Infrared thermometer**

Termometro a infrarossi  
Infrarot-Thermometer  
Thermomètre infrarouge  
Termómetro infrarrojo

art. scala range  
49717-00 1°C -50+400°C

**Dim. cm. 17,5x4x7,2**



**Infrared thermometer**

Termometro a infrarossi  
Infrarot-Thermometer  
Thermomètre infrarouge  
Termómetro infrarrojo

art. scala range  
49987-00 0,1°C -50+330°C

**Dim. cm. 3,6x8,8x13,1**



**Waterproof thermometer**

Termometro waterproof  
Waterproof-Thermometer  
Thermomètre waterproof  
Termómetro waterproof

art. scala range  
49711-00 0,1°C -50+300°C

**Dim. Ø 51x178 mm. Waterproof IP66. Auto-rotating display. S/steel penetration probe Ø 2,5x70 mm stainless steel, Ø 1,6 mm tip.**  
Impermeabile IP66. Display a rotazione automatica. Sonda di penetrazione inox Ø 2,5x70 mm., punta Ø 1,6 mm.

**NEW**



**Spatula with thermometer**  
Spatola con termometro  
Rührspaten mit Thermometer  
Spatule avec thermomètre  
Espátula con termómetro

art. range  
49729-00 -50+300°C

Dim. cm. 26x4x1,8



**Digital thermometer**  
Termometro digitale  
Elektronisches Thermometer  
Thermomètre digital  
Termómetro digital

| art.     | scala   | range         | col. |
|----------|---------|---------------|------|
| 49880-10 | 0,1/1°C | -49,9+299,9°C | ●    |
| 49880-11 | 0,1/1°C | -49,9+299,9°C | ●    |
| 49880-12 | 0,1/1°C | -49,9+299,9°C | ●    |

Dim. cm. 1,9x5x15,7. S/s probe Ø 3,3 x 115 mm. folds back through 180°.



**Digital thermometer**  
Termometro digitale  
Elektronisches Thermometer  
Thermomètre digital  
Termómetro digital

| art.     | scala   | range         | col. |
|----------|---------|---------------|------|
| 49880-13 | 0,1/1°C | -49,9+299,9°C | ●    |
| 49880-14 | 0,1/1°C | -49,9+299,9°C | ●    |
| 49880-15 | 0,1/1°C | -49,9+299,9°C | ○    |

Sonda inox ø 3,3 x 115 mm. pieghevole a 180°.



**Sous vide cooking thermometer**  
Termometro per sottovuoto  
Vakuüm-Koch-Thermometer  
Thermomètre pour cuisson sous-vide  
Termómetro cocción al vacío

| art.     | scala | range         |
|----------|-------|---------------|
| 49881-01 | 0,1°C | -99,9+299,9°C |
|          | 1°C   | +300+1372°C   |

Kit: termometro, Sous-Vide needle probe 60 mm., one metre foam/tape, zip pouch, free traceable certificate of calibration.

Kit: termometro, sonda per sottovuoto 60 mm., 1 metro di nastro adesivo, astuccio con zip, certificato di calibrazione tracciabile.



NEW

**Sous vide cooking thermometer**  
Termometro per sottovuoto  
Vakuüm-Koch-Thermometer  
Thermomètre pour cuisson sous-vide  
Termómetro cocción al vacío

| art.     | scala | range         |
|----------|-------|---------------|
| 49881-11 | 0,1°C | -49.9+299.9°C |
|          | 0,50% | 0>40% TPM     |

Dim. 1,9x4,7x15,3 cm. S/steel needle probe Ø 1,1 x 60 mm. FREE traceable certificate of calibration incl. – Sonda ad ago inox Ø 1,1 x 60 mm. Certificado di calibrazione incl.



NEW

**Sous vide foam tape**  
Nastro adesivo per sottovuoto  
Vakuümschaumklebeband  
Ruban adhésif pour sous-vide  
Cinta adhesiva para cocción al vacío

| art.     | l. cm. |
|----------|--------|
| 49881-99 | 100    |

Used in conjunction with thermometer to measure the core temperature without suffering water ingress into vacuum sealed bag.

Utilizzato in combinazione con il termometro evita che penetri acqua nel sacchetto sotto vuoto.



**ABS**

**Digital oven thermometer**  
Termometro digitale da forno  
Ofen-Digitalthermometer  
Thermomètre à four digital  
Termómetro horno digital

art.      Ø cm.    scala    range  
49719-00    8    1°C/F    -50+300°C

**Loud 70dB audible temperature alarm. 114 mm probe with 1,2 metre s/s braided lead that allows the probe to remain in the food during cooking. Water/dust resistance: IP65 protection.**

Allarme acustico 70dB. Sonda 114 mm., cavo inox 1,2 metri che permette l'utilizzo durante la cottura. Resistenza acqua/polvere. IP65.



**Oven timer, cooking thermometer**  
Timer, termometro da forno  
Digitalkochalarm  
Minuterie digitale  
Reloj, termómetro digital

art.      scala    range  
49718-00    1°C    0+300°C

**Dim. cm. 13x7,5x2. Count down/up from/to 23h 59m 59sec. High temperature probe cm 15 ø 4 mm. S/s braided lead 2 metres.**

Timer 23h 59min 59sec. Sonda ad alta temperatura 15 cm ø 4 mm. Cavo 2 metri.



**Waterproof digital timer**  
Timer digitale a tenuta stagna  
Wasserdichte Digitaltimer  
Timer digital étanche  
Reloj digital impermeable

art.      Ø cm.    h.  
49733-00    8    17

**99M-99S. Dust and flour proof. Sound and flashing alarms. Hanging hook and suction cup.**

A prova di polvere e farina. Suono e allarme lampeggiante. Gancio e ventosa.



**Digital timer**  
Timer digitale  
Digitalkochalarm  
Minuterie digitale  
Reloj digital

art.      cm.  
49720-00    7x5,5

**Timer 23H-59M-59S. Clock 12H AM/PM. Count down. 80dB audible alarm. Magnetic pad.**

Orologio 12H AM/PM. Cronometro. Allarme acustico 80dB. Attacco magnetico.



**Digital timer**  
Timer digitale  
Digitalkochalarm  
Minuterie digitale  
Reloj digital

art.      cm.  
49734-00    9x4,7x4,5

**Count-down/up: 23H 59M 59S. 80 dB sound. 1 AAA battery.**



**Digital timer jumbo**  
Timer digitale gigante  
Digitalkochalarm jumbo  
Minuterie digitale géante  
Reloj digital gigante

art.      cm.  
49735-00    13,5x9,5x16

**4 possible programs. Electrical plug & battery. Waterproof front panel IP54. 80 dB sound. 6F22 battery.**



**NEW**

**ABS**

**Thermohygrometer with clock**  
Termoigrometro con orologio  
Thermohygrometer mit Uhr  
Thermohygromètre avec horloge  
Termohigrómetro con reloj

art.      cm.      range  
49721-03    13x10x2,5    -20+50°C

**10-99% RH - 12/24 H.**



**Syrup density meter**  
Pesa sciroppo, densimetro  
Sirup-Hydrometer  
Pèse-sirop  
Aerómetro

art.      l. cm.  
49703-00    12,5

**g/ml/°Bé: 1.100-1.400/15-40 - °C20 - Div.: 0,010 g/ml/2°Bé.**



**Hydrometer for brine and salt**  
Densimetro per salamoia e sale  
Hydrometer für Sole und Salz  
Densimètre pour saumure et sel  
Hidrómetro salmuera y sal

art.      l. cm.  
49730-20    19,5

**g/ml/°Bé: 1.000-1.250/0-30 - °C20 - Div.: 0,001 g/ml/2°Bé.**



ABS  
PP

**Salt tester and thermometer**

Salinometro e termometro  
Salzgehalt-Meter u. Thermometer  
Testeur de salinité et thermometer  
Salinometro y termómetro

art. cm.

49730-00 3,2x1,6x22,5

To measure the salt content of food and liquids in percentage from 0 to 5%. Temperature from 0°+100°C. – Per misurare il tenore di sale in alimenti e liquidi in percentuale da 0 a 5%. Temperatura da 0°+100° C.



NEW

**Frying oil test strips**

Strisce reattive per oli di frittura  
Bratöl-Teststreifen  
Bandes réactives pour les huiles de friture  
Tiras reactivas para control aceites

art.

49731-99

Storage bottles of 100 Oil Quality Test Strips and easy to read colour chart. Hold the test strip in the oil for 2 seconds (max 40°C), then remove it and wait 2 minutes, next, compare the strip to the colour chart. – Flacone con 100 strisce reattive e tabella colori di facile lettura. Immergere la fascia colorata della striscia nell'olio (max. 40°C) per 2 secondi, quindi rimuoverla e attendere 2 minuti. Confrontare la striscia con la tabella colori.



NEW  
ABS  
SS

art. range pairs/paia

49723-00 0,1°C +30+200°C

Dim. 3,1x4,8x36,5 cm. Suitable for measuring olive oil, palm oil, rapeseed oil, peanut oil, soybean oil, sesame oil, vegetable oils and animal fats – Adatto per misurare olio di oliva, palma, colza, arachidi, soia, sesamo, oli vegetali e grassi animali.



**Frying oil tester**

Test degradazione oli di frittura  
Kontrollsystem für Bratenöle  
Test dégradation des huiles de friture  
Test para control aceites

art.

49731-10

Consisting of two reagents that are not harmful to health and environmentally friendly. For 20 tests. ATTENTION: works with all types and brands of frying oil, (except with palm oil). – Composto da due reagenti non nocivi per la salute e rispettosi dell'ambiente. Per 20 test. ATTENZIONE: funziona con tutti i tipi e le marche di olio di frittura, (tranne che con l'olio di palma).



NEW OIL <9% of polar compounds  
OLIO NUOVO <9% di composti polari  
GOOD OIL from 10 to 16% of polar compounds  
OLIO BUONO da 10 a 16% di composti polari  
DETERIORATED OIL from 17 to 23% of polar compounds  
OLIO DETERIORATO da 17 a 23% di composti polari  
OIL TO CHANGE >24% of polar compounds  
OLIO DA CAMBIARE >24% di composti polari



**Labels solvable**

Etichette dissolvibili  
Lösbare Etiketten  
Etiquettes solubles  
Etiquetas solubles

art. cm. pcs/pz

44630-01 7,5x4 250

Dissolvable in less than 20 seconds. Suitable for any type of surface. – Dissolvibili in meno di 20 secondi. Adatte a qualsiasi tipo di superficie.



**Labels 14 allergens**

Etichette 14 allergeni  
Etiketten 14 Allergene  
Etiquettes 14 allergènes  
Etiquetas 14 alergenos

art. cm. pcs/pz  
44630-02 7,5x4 500

**Labels with all 14 allergens pre-printed.**  
Etichette con i 14 allergeni prestampati.



**Labels Express 7 days**

Etichette express 7giorni  
Etiketten Express 7 Tage  
Etiquettes express 7 jours  
Etiquetas express 7 dias

art. cm. pcs/pz  
44630-03 3x2,5 1750

**Different colors based on the day of the week.**  
**Data to be written: product description; date of production or expiry date.** – Diversi colori in base al giorno della settimana. Dati da inserire: descrizione del prodotto; data di produzione o data di scadenza.



**NEW**

**Labels frozen food**

Etichette frozen/surgelati  
Etiketten Tiefkühlkost  
Etiquettes aliments surgelés  
Etiquetas alimentos congelados

art. cm. pcs/pz  
44630-04 7x4,5 500



**NEW**

**Labels TMC**

Etichette TMC  
Etiketten TMC  
Etiquettes TMC  
Etiquetas TMC

art. cm. pcs/pz  
44630-05 7x4,5 500

**TMC: Termine minimo di conservazione.**

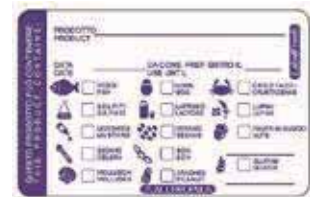

**NEW**

**Labels Allergens**

Etichette allergeni  
Etiketten Allergene  
Etiquettes allergènes  
Etiquetas alérgenos

art. cm. pcs/pz  
44630-06 7x4,5 500



**NEW**

**Labels delivery with allergens**

Etichette delivery con allergeni  
Etiketten Lieferung mit Allergenen  
Etiquettes livraison avec allergènes  
Etiquetas entrega con alérgenos

art. cm. pcs/pz  
44630-07 14x4,5 250



**NEW**

**Wall clock ORION**

Orologio da parete  
Wanduhr  
Horloge à pari  
Reloj de pared

art. Ø cm.  
41380-01 29

**Satin alloy.** – Metallo satinato.



**ABS**

**Wall clock SILENT**

Orologio da parete  
Wanduhr  
Horloge à pari  
Reloj de pared

art. Ø cm.  
41380-02 30,5

**Silent clock.** – Movimento silenzioso.





ABS

SS

**Digital scale**

Bilancia digitale  
Präzisionswaage  
Balance digitale  
Balanza digital

| art.     | cm.           | Kg. | scala |
|----------|---------------|-----|-------|
| 49865-06 | 21,6x17,1x6,3 | 6   | 1g    |

**Antimicrobial protection. Portion count. Removable platform cm 14,6x16,5. AC adapter/batteries supply.** – Protezione antimicrobica. Conteggio porzioni. Piattaforma cm 4,6x16,5. Adattatore AC/batterie.



**Digital scale**

Bilancia digitale  
Präzisionswaage  
Balance digitale  
Balanza digital

| art.     | cm.           | Kg. | scala |
|----------|---------------|-----|-------|
| 49865-70 | 30,5x31,8x5,7 | 68  | 100g  |

**Platform cm 30,5x30,5. Remote LCD wall mount display. Electric or batteries supply.** Piattaforma cm 30,5x30,5. Schermo LCD rimovibile per montaggio a parete. Alimentazione corrente/batteria.



SS

**Mechanical scale**

Bilancia meccanica  
Waage  
Balance  
Balanza

| art.     | Ø cm. | Kg. | scala |
|----------|-------|-----|-------|
| 49864-03 | 20    | 3   | 10g   |
| 49864-05 | 20    | 5   | 20g   |



SS

**Mechanical scale**

Bilancia meccanica  
Waage  
Balance  
Balanza

| art.     | Ø cm. | Kg. | scala |
|----------|-------|-----|-------|
| 49864-20 | 25    | 20  | 100g  |



SS

**Digital kitchen scale**

Bilancia digitale da cucina  
Digital-Küchenwaage  
Balance de cuisine  
Balanza digital de cocina

| art.     | cm.     | Kg. | scala |
|----------|---------|-----|-------|
| 49773-05 | 21,5x13 | 5   | 1g    |



NEW

SS

ABS

**Digital kitchen scale**

Bilancia digitale da cucina  
Digital-Küchenwaage  
Balance de cuisine  
Balanza digital de cocina

| art.     | cm.         | Kg. | scala |
|----------|-------------|-----|-------|
| 49774-05 | 22,5x16,5x2 | 5   | 1g    |



**Pocket scale**

Bilancia tascabile  
Taschenwaage  
Balance de poche  
Balanza de bolsillo

| art.     | cm.       | Kg.  | scala |
|----------|-----------|------|-------|
| 49771-00 | 15x10x2,5 | 0,25 | 0,1 g |



NEW

SS

ABS

**Pocket scale**

Bilancia tascabile  
Taschenwaage  
Balance de poche  
Balanza de bolsillo

| art.     | cm.        | Kg. | scala |
|----------|------------|-----|-------|
| 49772-01 | 12,7x7,6x2 | 1   | 0,1 g |



ABS  
SS

**Digital scale**  
Bilancia digitale  
Digitalwaage  
Balance digitale  
Balanza digital

| art.     | cm.         | Kg. | scala |
|----------|-------------|-----|-------|
| 49775-05 | 24,5x31x9,5 | 5   | 1g    |
| 49775-10 | 24,5x31x9,5 | 10  | 1g    |



ABS  
SS

**Digital scale**  
Bilancia digitale  
Digitalwaage  
Balance digitale  
Balanza digital

| art.     | cm.        | Kg. | scala |
|----------|------------|-----|-------|
| 49777-50 | 29x33,5x11 | 50  | 1g    |

Unit: Kg/lb.



SS

**Digital scale**  
Bilancia digitale  
Digitalwaage  
Balance digitale  
Balanza digital

| art.     | cm.      | Kg. | scala |
|----------|----------|-----|-------|
| 49776-15 | 24x29x11 | 15  | 1g    |
| 49776-30 | 24x29x11 | 30  | 2g    |



ABS  
SS

**Digital scale with platform**  
Bilancia digitale con piattaforma  
Digitalwaage mit Plattform  
Balance digitale avec plate-forme  
Balanza digital con plataforma

| art.     | cm.      | Kg. | scala |
|----------|----------|-----|-------|
| 49779-15 | 50x40x84 | 150 | 20g   |
| 49779-30 | 60x50x84 | 300 | 50g   |



# SERIES 18100

FORGED KNIVES  
COLTELLI FORGIATI



A deep study and computerised tests of ergonomics, movement and posture have allowed Paderno to create a professional knives line, that is the synthesis of comfort and cutting precision. Handle made of plastic specially developed for the food processing sector, ergonomic design with soft edges, perfect grip to ensure precise guidance. The forged blade realised in special steel and molybdenum/vanadium, thanks to a peculiar hardening process, guarantees to the product a perfect cut and a long life of the blade's edge.

Uno studio approfondito e prove computerizzate di ergonomia, movimento e postura hanno permesso a Paderno di creare una linea di coltelli professionali, sintesi perfetta tra comfort e perfezione del taglio. Manico realizzato in speciale materiale plastico sviluppato per il settore alimentare, design ergonomico con bordi arrotondati, presa perfetta per garantire un taglio di precisione. Lama forgiata realizzata in lega di speciale acciaio, molibdeno e vanadio con particolare processo di tempra che garantisce al prodotto un ottimo taglio ed una perfetta e lunga tenuta di filo.



**Cook's knife**

Coltello cucina  
Kochmesser  
Couteau cuisine  
Cuchillo de cocinero

| art.     | cm. |
|----------|-----|
| 18100-16 | 16  |
| 18100-20 | 20  |
| 18100-24 | 24  |
| 18100-30 | 30  |
| 18100-36 | 36  |



**Butcher's knife**

Coltello francese  
Kochmesser  
Couteau de chef  
Cuchillo de carnicero

| art.     | cm. |
|----------|-----|
| 18102-16 | 16  |
| 18102-20 | 20  |
| 18102-26 | 26  |
| 18102-30 | 30  |



**Oriental cook's knife**

Coltello cucina orientale  
Japanisches Kochmesser  
Couteau de chef style japonais  
Cuchillo cocinero japonés

| art.     | cm. |
|----------|-----|
| 18103-18 | 18  |



**Oriental cook's knife, dimpled ground**

Coltello cucina orientale, alveolato  
Japanisches Kochmesser mit Kullenschliff  
Couteau de chef style japonais alveolé  
Cuchillo cocinero japonés, con alvéolos

| art.     | cm. |
|----------|-----|
| 18104-18 | 18  |



**Slicer**

Coltello affettare  
Fleischmesser  
Tranchelard  
Cuchillo para filetear

| art.     | cm. |
|----------|-----|
| 18106-15 | 15  |
| 18106-20 | 20  |
| 18106-25 | 25  |
| 18106-30 | 30  |



**Ham knife**

Coltello prosciutto  
Schinkenmesser  
Trancheur à rôti  
Cuchillo para jamón

| art.     | cm. |
|----------|-----|
| 18109-26 | 26  |
| 18109-30 | 30  |
| 18109-36 | 36  |



**Ham knife, dimpled ground**

Coltello prosciutto, alveolato  
Schinkenmesser mit Kullenschliff  
Couteau à rôti alvéolé  
Cuchillo para jamón, con alvéolos

| art.     | cm. |
|----------|-----|
| 18110-26 | 26  |
| 18110-30 | 30  |
| 18110-36 | 36  |



**Salmon knife**

Coltello salmone  
Lachsmesser  
Couteau à saumon  
Cuchillo para salmón

| art.     | cm. |
|----------|-----|
| 18111-30 | 30  |



**Salmon knife, dimpled ground**

Coltello salmone, alveolato  
Lachsmesser mit Kullenschliff  
Couteau à saumon alvéolé  
Cuchillo para salmón, con alvéolos

| art.     | cm. |
|----------|-----|
| 18112-30 | 30  |



**Carving knife**

Coltello trinciante  
Filiermesser  
Couteau à découper  
Cuchillo para trinchar

| art.     | cm. |
|----------|-----|
| 18114-20 | 20  |



**Filleting, flexible**

Coltello filettare, flessibile  
Filiermesser, flexibel  
Filet de sole, flexible  
Cuchillo para filetear, flexible

| art.     | cm. |
|----------|-----|
| 18115-20 | 20  |
| 18115-25 | 25  |



**Boning knife**

Coltello disosso  
Ausbeinmesser  
Couteau à désosser  
Cuchillo para deshuesar

| art.     | cm. |
|----------|-----|
| 18116-14 | 14  |
| 18116-18 | 18  |



**Steak knife**

Coltello bistecca  
Steakmesser  
Couteau à steak  
Cuchillo para steak

| art.     | cm. |
|----------|-----|
| 18122-12 | 12  |



**Paring knife**

Spelucchino  
Spickmesser  
Couteau d'office  
Cuchillo mondador

| art.     | cm. |
|----------|-----|
| 18124-09 | 9   |



**Paring knife**

Spelucchino  
Spickmesser  
Couteau d'office  
Cuchillo mondador

| art.     | cm. |
|----------|-----|
| 18125-07 | 7   |
| 18125-10 | 10  |



**Bent paring knife**

Coltello cuoco  
Tourniermesser  
Bec d'oiseau  
Cuchillo verdura

| art.     | cm. |
|----------|-----|
| 18126-07 | 7   |



**Table knife**

Coltello tavola  
Allzweckmesser  
Couteau bout rond cranté  
Cuchillo para mesa

| art.     | cm. |
|----------|-----|
| 18123-11 | 11  |



**Bread knife**

Coltello pane  
Brotmesser mit Wellenschliff  
Couteau à pain ondulé  
Cuchillo para pan

| art.     | cm. |
|----------|-----|
| 18128-20 | 20  |
| 18128-24 | 24  |
| 18128-30 | 30  |



**Meat fork**

Forchettone  
Fleischgabel  
Fourchette diapason  
Tenedor para carne

| art.     | cm. |
|----------|-----|
| 18230-13 | 13  |
| 18230-17 | 17  |



**Carving fork curved**

Forchettone curvo  
Fleischgabel  
Fourchette à viande  
Tenedor curvo para carne

| art.     | cm. |
|----------|-----|
| 18231-13 | 13  |



# SERIES 18000

STAMPED KNIVES  
COLTELLI TRANCIATI



The professional cutlery line “Color-Line” helps to reduce the risk of cross contamination using a Color Coding System which identifies each knife with a specific task: different food processing areas are easily identified. The steel used for this cutlery line has exceptional hardness and very high resistance to corrosion due to ICE-HARDENED system, a special process to harden the steel.

La linea di coltelleria professionale “CCS”– Color Coding System riduce i rischi di contaminazione incrociata grazie all'utilizzo di un Sistema di Codifica dei Colori che identifica ogni coltello per un uso specifico e permette di individuare facilmente le diverse aree di lavoro. Gli acciai utilizzati per questa linea di coltelleria presentano un'eccezionale durezza ed elevata resistenza alla corrosione, grazie all'uso del sistema ICE-HARDENING, processo speciale per temprare l'acciaio.



**Cook's knife**

Coltello cucina  
Kochmesser  
Couteau cuisine  
Cuchillo de cocinero

| art.     | cm. | col. |
|----------|-----|------|
| 18000-16 | 16  | ●    |
| 18000-20 | 20  | ●    |
| 18000-23 | 23  | ●    |
| 18000-26 | 26  | ●    |
| 18000-30 | 30  | ●    |
| 18000-36 | 36  | ●    |



**Cook's knife**

Coltello cucina  
Kochmesser  
Couteau cuisine  
Cuchillo de cocinero

| art.     | cm. | col. |
|----------|-----|------|
| 18000B16 | 16  | ●    |
| 18000B20 | 20  | ●    |
| 18000B23 | 23  | ●    |
| 18000B26 | 26  | ●    |
| 18000B30 | 30  | ●    |



**Cook's knife**

Coltello cucina  
Kochmesser  
Couteau cuisine  
Cuchillo de cocinero

| art.     | cm. | col. |
|----------|-----|------|
| 18000G16 | 16  | ●    |
| 18000G20 | 20  | ●    |
| 18000G23 | 23  | ●    |
| 18000G26 | 26  | ●    |
| 18000G30 | 30  | ●    |



**Cook's knife**

Coltello cucina  
Kochmesser  
Couteau cuisine  
Cuchillo de cocinero

| art.     | cm. | col. |
|----------|-----|------|
| 18000M16 | 16  | ●    |
| 18000M20 | 20  | ●    |
| 18000M23 | 23  | ●    |
| 18000M26 | 26  | ●    |



**Cook's knife**

Coltello cucina  
Kochmesser  
Couteau cuisine  
Cuchillo de cocinero

| art.     | cm. | col. |
|----------|-----|------|
| 18000R16 | 16  | ●    |
| 18000R20 | 20  | ●    |
| 18000R23 | 23  | ●    |
| 18000R26 | 26  | ●    |
| 18000R30 | 30  | ●    |



**Cook's knife**

Coltello cucina  
Kochmesser  
Couteau cuisine  
Cuchillo de cocinero

| art.     | cm. | col. |
|----------|-----|------|
| 18000W20 | 20  | ○    |
| 18000W26 | 26  | ○    |
| 18000W30 | 30  | ○    |



**Cook's knife**

Coltello cucina  
Kochmesser  
Couteau cuisine  
Cuchillo de cocinero

| art.     | cm. | col. |
|----------|-----|------|
| 18000Y16 | 16  | ●    |
| 18000Y20 | 20  | ●    |
| 18000Y23 | 23  | ●    |
| 18000Y26 | 26  | ●    |



**Butcher's knife**

Coltello scimitarra  
Blockmesser  
Couteau à découper  
Cuchillo de carnicero

| art.     | cm. | col. |
|----------|-----|------|
| 18005-22 | 22  | ●    |
| 18005-27 | 27  | ●    |
| 18005-32 | 32  | ●    |



**Butcher's knife**

Coltello scimitarra  
Blockmesser  
Couteau à découper  
Cuchillo de carnicero

| art.     | cm. | col. |
|----------|-----|------|
| 18005B22 | 22  | ●    |
| 18005B27 | 27  | ●    |
| 18005B32 | 32  | ●    |



**Butcher's knife**

Coltello scimitarra  
Blockmesser  
Couteau à découper  
Cuchillo de carnicero

| art.     | cm. | col. |
|----------|-----|------|
| 18005G22 | 22  | ●    |
| 18005G27 | 27  | ●    |
| 18005G32 | 32  | ●    |



**Butcher's knife**

Coltello scimitarra  
Blockmesser  
Couteau à découper  
Cuchillo de carnicero

| art.     | cm. | col. |
|----------|-----|------|
| 18005R22 | 22  | ●    |
| 18005R27 | 27  | ●    |
| 18005R32 | 32  | ●    |



**Butcher's knife**

Coltello scimitarra  
Blockmesser  
Couteau à découper  
Cuchillo de carnicero

| art.     | cm. | col. |
|----------|-----|------|
| 18005Y22 | 22  | ●    |
| 18005Y27 | 27  | ●    |
| 18005Y32 | 32  | ●    |



**Butcher's knife**

Coltello francese  
Schlachtsmesser  
Couteau à découper  
Cuchillo carnicero francés

| art.     | cm. | col. |
|----------|-----|------|
| 18002-18 | 18  | ●    |
| 18002-20 | 20  | ●    |
| 18002-22 | 22  | ●    |
| 18002-26 | 26  | ●    |
| 18002-30 | 30  | ●    |
| 18002-36 | 36  | ●    |



**Butcher's knife**

Coltello francese  
Schlachtsmesser  
Couteau à découper  
Cuchillo carnicero francés

| art.     | cm. | col. |
|----------|-----|------|
| 18002B26 | 26  | ●    |



**Butcher's knife**

Coltello francese  
Schlachtsmesser  
Couteau à découper  
Cuchillo carnicero francés

| art.     | cm. | col. |
|----------|-----|------|
| 18002R18 | 18  | ●    |
| 18002R20 | 20  | ●    |
| 18002R22 | 22  | ●    |
| 18002R26 | 26  | ●    |
| 18002R30 | 30  | ●    |
| 18002R36 | 36  | ●    |



**Butcher's knife**

Coltello francese  
Schlachtsmesser  
Couteau à découper  
Cuchillo carnicero francés

| art.     | cm. | col. |
|----------|-----|------|
| 18002Y18 | 18  | ●    |
| 18002Y26 | 26  | ●    |
| 18002Y30 | 30  | ●    |
| 18002Y36 | 36  | ●    |





**Slicer knife**

Coltello affettare  
Wurstmesser  
Couteau à jambon  
Cuchillo para filetear

| art.     | cm. | col. |
|----------|-----|------|
| 18006-20 | 20  | ●    |
| 18006-25 | 25  | ●    |
| 18006-30 | 30  | ●    |
| 18006-36 | 36  | ●    |



**Slicer knife**

Coltello affettare  
Wurstmesser  
Couteau à jambon  
Cuchillo para filetear

| art.     | cm. | col. |
|----------|-----|------|
| 18006B20 | 20  | ●    |
| 18006B25 | 25  | ●    |
| 18006B30 | 30  | ●    |



**Slicer knife**

Coltello affettare  
Wurstmesser  
Couteau à jambon  
Cuchillo para filetear

| art.     | cm. | col. |
|----------|-----|------|
| 18006G20 | 20  | ●    |
| 18006G25 | 25  | ●    |



**Slicer knife**

Coltello affettare  
Wurstmesser  
Couteau à jambon  
Cuchillo para filetear

| art.     | cm. | col. |
|----------|-----|------|
| 18006R20 | 20  | ●    |
| 18006R25 | 25  | ●    |
| 18006R30 | 30  | ●    |



**Slicer knife**

Coltello affettare  
Wurstmesser  
Couteau à jambon  
Cuchillo para filetear

| art.     | cm. | col. |
|----------|-----|------|
| 18006Y20 | 20  | ●    |
| 18006Y25 | 25  | ●    |
| 18006Y30 | 30  | ●    |



**Slicer knife, wavy blade**

Coltello affettare, dentato  
Wurstmesser mit Wellenschliff  
Couteau à jambon ondulé  
Cuchillo para filetear, dentado

| art.     | cm. | col. |
|----------|-----|------|
| 18007-25 | 25  | ●    |
| 18007-30 | 30  | ●    |
| 18007-36 | 36  | ●    |



**Slicer knife, wavy blade**

Coltello affettare, dentato  
Wurstmesser mit Wellenschliff  
Couteau à jambon ondulé  
Cuchillo para filetear, dentado

| art.     | cm. | col. |
|----------|-----|------|
| 18007G30 | 30  | ●    |



**Cook's knife**

Coltello cucina  
Kochmesser  
Couteau cuisine  
Cuchillo cocina

| art.     | cm. | col. |
|----------|-----|------|
| 18008-20 | 20  | ●    |
| 18008-26 | 26  | ●    |
| 18008-30 | 30  | ●    |
| 18008-36 | 36  | ●    |



**Cook's knife**

Coltello cucina  
Kochmesser  
Couteau cuisine  
Cuchillo cocina

| art.     | cm. | col. |
|----------|-----|------|
| 18008B30 | 30  | ●    |



**Cook's knife**

Coltello cucina  
Kochmesser  
Couteau cuisine  
Cuchillo cocina

| art.     | cm. | col. |
|----------|-----|------|
| 18008R26 | 26  | ●    |
| 18008R30 | 30  | ●    |
| 18008R36 | 36  | ●    |



**Cook's knife**

Coltello cucina  
Kochmesser  
Couteau cuisine  
Cuchillo cocina

| art.     | cm. | col. |
|----------|-----|------|
| 18008Y30 | 30  | ●    |



**Ham knife**

Coltello prosciutto  
Schinkenmesser  
Trancheur à rôti  
Cuchillo para jamón

| art.     | cm. | col. |
|----------|-----|------|
| 18009-25 | 25  | ●    |
| 18009-30 | 30  | ●    |
| 18009-36 | 36  | ●    |



**Ham knife**

Coltello prosciutto  
Schinkenmesser  
Trancheur à rôti  
Cuchillo para jamón

| art.     | cm. | col. |
|----------|-----|------|
| 18009B25 | 25  | ●    |
| 18009B30 | 30  | ●    |



**Ham knife**

Coltello prosciutto  
Schinkenmesser  
Trancheur à rôti  
Cuchillo para jamón

| art.     | cm. | col. |
|----------|-----|------|
| 18009G25 | 25  | ●    |
| 18009G30 | 30  | ●    |



**Ham knife**

Coltello prosciutto  
Schinkenmesser  
Trancheur à rôti  
Cuchillo para jamón

| art.     | cm. | col. |
|----------|-----|------|
| 18009M25 | 25  | ●    |



**Ham knife**

Coltello prosciutto  
Schinkenmesser  
Trancheur à rôti  
Cuchillo para jamón

| art.     | cm. | col. |
|----------|-----|------|
| 18009R25 | 25  | ●    |
| 18009R30 | 30  | ●    |



**Ham knife**

Coltello prosciutto  
Schinkenmesser  
Trancheur à rôti  
Cuchillo para jamón

| art.     | cm. | col. |
|----------|-----|------|
| 18009W25 | 25  | ○    |
| 18009W30 | 30  | ○    |



**Ham knife**

Coltello prosciutto  
Schinkenmesser  
Trancheur à rôti  
Cuchillo para jamón

| art.     | cm. | col. |
|----------|-----|------|
| 18009Y25 | 25  | ●    |
| 18009Y30 | 30  | ●    |



**Salmon knife**

Coltello salmone  
Lachsmesser  
Couteau à saumon  
Cuchillo salmón

| art.     | cm. | col. |
|----------|-----|------|
| 18011-32 | 32  | ●    |



**Ham knife, dimpled ground**

Coltello prosciutto, alveolato  
Schinkenmesser mit Kullenschliff  
Couteau à rôti alvéolé  
Cuchillo jamón con alvéolos

| art.     | cm. | col. |
|----------|-----|------|
| 18010-25 | 25  | ●    |
| 18010-30 | 30  | ●    |
| 18010-36 | 36  | ●    |



**Ham knife, dimpled ground**  
Coltello prosciutto, alveolato  
Schinkenmesser mit Kullenschliff  
Couteau à rôti alvéolé  
Cuchillo jamón con alvéolos

| art.     | cm. | col. |
|----------|-----|------|
| 18010Y30 | 30  | ●    |



**Salmon knife, dimpled ground**  
Coltello salmone, alveolato  
Lachsmesser mit Kullenschliff  
Couteau à saumon alvéolé  
Cuchillo salmón con alvéolos

| art.     | cm. | col. |
|----------|-----|------|
| 18012-32 | 32  | ●    |
| 18012B32 | 32  | ●    |



**Cheese slicer**  
Coltello salati/Formaggio  
Universalmesser  
Couteau universel  
Cuchillo universal/quesos

| art.     | cm. | col. |
|----------|-----|------|
| 18013-30 | 30  | ●    |
| 18013-36 | 36  | ●    |



**Cheese slicer**  
Coltello salati/Formaggio  
Universalmesser  
Couteau universel  
Cuchillo universal/quesos

| art.     | cm. | col. |
|----------|-----|------|
| 18013G36 | 36  | ●    |



**Cheese slicer**  
Coltello salati/Formaggio  
Universalmesser  
Couteau universel  
Cuchillo universal/quesos

| art.     | cm. | col. |
|----------|-----|------|
| 18013W30 | 30  | ○    |
| 18013W36 | 36  | ○    |



**Filetting knife**  
Coltello per filettare  
Filiermesser  
Filet de sole  
Cuchillo para filetear

| art.     | cm. | col. |
|----------|-----|------|
| 18015-18 | 18  | ●    |
| 18015-22 | 22  | ●    |
| 18015-27 | 27  | ●    |



**Filetting knife**  
Coltello per filettare  
Filiermesser  
Filet de sole  
Cuchillo para filetear

| art.     | cm. | col. |
|----------|-----|------|
| 18015B18 | 18  | ●    |
| 18015B22 | 22  | ●    |



**Filetting knife**  
Coltello per filettare  
Filiermesser  
Filet de sole  
Cuchillo para filetear

| art.     | cm. | col. |
|----------|-----|------|
| 18015R18 | 18  | ●    |
| 18015R22 | 22  | ●    |



**Filetting knife**  
Coltello per filettare  
Filiermesser  
Filet de sole  
Cuchillo para filetear

| art.     | cm. | col. |
|----------|-----|------|
| 18015Y18 | 18  | ●    |
| 18015Y27 | 27  | ●    |



**Boning knife**  
Coltello disosso  
Ausbeinmesser  
Couteau à désosser  
Cuchillo para deshuesar

| art.     | cm. | col. |
|----------|-----|------|
| 18016-14 | 14  | ●    |
| 18016-16 | 16  | ●    |



**Boning knife**  
Coltello disosso  
Ausbeinmesser  
Couteau à désosser  
Cuchillo para deshuesar

| art.     | cm. | col. |
|----------|-----|------|
| 18016B14 | 14  | ●    |
| 18016B16 | 16  | ●    |



**Boning knife**  
Coltello disosso  
Ausbeinmesser  
Couteau à désosser  
Cuchillo para deshuesar

| art.     | cm. | col. |
|----------|-----|------|
| 18016R14 | 14  | ●    |
| 18016R16 | 16  | ●    |



**Boning knife**

Coltello disosso  
Ausbeinmesser  
Couteau à désosser  
Cuchillo para deshuesar

| art.     | cm. | col. |
|----------|-----|------|
| 18016W16 | 16  | ○    |



**Boning knife**

Coltello disosso  
Ausbeinmesser  
Couteau à désosser  
Cuchillo para deshuesar

| art.     | cm. | col. |
|----------|-----|------|
| 18016Y14 | 14  | ●    |
| 18016Y16 | 16  | ●    |



**Boning knife**

Coltello disosso emilia  
Ausbeinmesser  
Couteau à désosser  
Cuchillo para deshuesar

| art.     | cm. | col. |
|----------|-----|------|
| 18017-14 | 14  | ●    |
| 18017-16 | 16  | ●    |
| 18017-18 | 18  | ●    |



**Boning knife**

Coltello disosso emilia  
Ausbeinmesser  
Couteau à désosser  
Cuchillo para deshuesar

| art.     | cm. | col. |
|----------|-----|------|
| 18017B16 | 16  | ●    |
| 18017R16 | 16  | ●    |
| 18017Y16 | 16  | ●    |



**Poultry sticking knife**

Coltello scannapolli  
Geflügelschlachtmesser  
Couteau à volaille  
Cuchillo para deshuesar

| art.     | cm. | col. |
|----------|-----|------|
| 18018-11 | 11  | ●    |
| 18018R11 | 11  | ●    |
| 18018Y11 | 11  | ●    |



**Sticking knife**

Coltello scannare  
Stechmesser  
Couteau à saigner  
Cuchillo para destrozor

| art.     | cm. | col. |
|----------|-----|------|
| 18019-12 | 12  | ●    |
| 18019-14 | 14  | ●    |
| 18019-16 | 16  | ●    |
| 18019-18 | 18  | ●    |
| 18019-20 | 20  | ●    |



**Sticking knife**

Coltello scannare  
Stechmesser  
Couteau à saigner  
Cuchillo para destrozor

| art.     | cm. | col. |
|----------|-----|------|
| 18019R12 | 12  | ●    |
| 18019R16 | 16  | ●    |
| 18019R18 | 18  | ●    |
| 18019R20 | 20  | ●    |



**Frozen food, two serrated edges**

Coltello surgelati a doppia lama seghettata  
Tiefkühltruhenmesser, Gezahnter Schliff  
Couteau dentelé pour produits surgelés  
Cuchillo para congelados, hoja doble, dentada

| art.     | cm. | col. |
|----------|-----|------|
| 18020-23 | 23  | ●    |
| 18020B23 | 23  | ●    |
| 18020R23 | 23  | ●    |



**Frozen food special serrated blade**

Coltello surgelati lama seghettata speciale  
Tiefkühltruhenmesser, Gezahnter Schliff  
Couteau dentelé pour produits surgelés  
Cuchillo para congelados, dentado especial

| art.     | cm. | col. |
|----------|-----|------|
| 18021-18 | 18  | ●    |
| 18021B18 | 18  | ●    |
| 18021R18 | 18  | ●    |



**Steak knife**

Coltello bistecca  
Steakmesser  
Couteau à steak  
Cuchillo para steak

| art.     | cm. | col. |
|----------|-----|------|
| 18022-12 | 12  | ●    |



**Table knife, half-waved**

Coltello tavola, mezzo dentato  
Allzweckmesser  
Couteau universel  
Cuchillo mesa, medio dentado

| art.     | cm. | col. |
|----------|-----|------|
| 18023-11 | 11  | ●    |



**Paring knife**

Spelucchino  
Spickmesser  
Couteau d'office  
Cuchillo mondador

| art.     | cm. | col. |
|----------|-----|------|
| 18024-08 | 8   | ●    |
| 18024-11 | 11  | ●    |



**Paring knife**

Spelucchino  
Spickmesser  
Couteau d'office  
Cuchillo mondador

| art.     | cm. | col. |
|----------|-----|------|
| 18024G08 | 8   | ●    |
| 18024G11 | 11  | ●    |



**Paring knife**

Spelucchino  
Spickmesser  
Couteau d'office  
Cuchillo mondador

| art.     | cm. | col. |
|----------|-----|------|
| 18024R08 | 8   | ●    |
| 18024R11 | 11  | ●    |



**Paring knife**

Spelucchino  
Spickmesser  
Couteau d'office  
Cuchillo mondador

| art.     | cm. | col. |
|----------|-----|------|
| 18024Y08 | 8   | ●    |



**Bent paring knife**

Spelucchino  
Tourniermesser  
Bec d'oiseau  
Cuchillo verdura

| art.     | cm. | col. |
|----------|-----|------|
| 18026G07 | 7   | ●    |
| 18026M07 | 7   | ●    |



**Steak knife**

Coltello bistecca  
Steakmesser  
Couteau à steak  
Cuchillo para steak

| art.     | cm. | U. Pack | col. |
|----------|-----|---------|------|
| 18217-12 | 12  | 6       | ●    |



**Paring knife**

Spelucchino  
Spickmesser  
Couteau d'office  
Cuchillo mondador

| art.     | cm. | col. |
|----------|-----|------|
| 18024B08 | 8   | ●    |
| 18024B11 | 11  | ●    |



**Paring knife**

Spelucchino  
Spickmesser  
Couteau d'office  
Cuchillo mondador

| art.     | cm. | col. |
|----------|-----|------|
| 18024M08 | 8   | ●    |
| 18024M11 | 11  | ●    |



**Paring knife**

Spelucchino  
Spickmesser  
Couteau d'office  
Cuchillo mondador

| art.     | cm. | col. |
|----------|-----|------|
| 18024W08 | 8   | ○    |
| 18024W11 | 11  | ○    |



**Bent paring knife**

Spelucchino  
Tourniermesser  
Bec d'oiseau  
Cuchillo verdura

| art.     | cm. | col. |
|----------|-----|------|
| 18026-07 | 7   | ●    |
| 18026B07 | 7   | ●    |



**Baker's knife**

Coltello pasticceria  
Bäckermesser  
Couteau de pâtissier  
Cuchillo para pastelería

| art.     | cm. | col. |
|----------|-----|------|
| 18029-30 | 30  | ●    |
| 18029-36 | 36  | ●    |





**Baker's knife**

Coltello pasticceria  
Bäckermesser  
Couteau de pâtissier  
Cuchillo para pastelería

| art.     | cm. | col. |
|----------|-----|------|
| 18029W25 | 25  | ○    |
| 18029W30 | 30  | ○    |
| 18029W36 | 36  | ○    |



**Bread knife**

Coltello pane  
Brotmesser  
Couteau à pain  
Cuchillo para pan

| art.     | cm. | col. |
|----------|-----|------|
| 18028-21 | 21  | ●    |



**Bread knife**

Coltello pane  
Brotmesser  
Couteau à pain  
Cuchillo para pan

| art.     | cm. | col. |
|----------|-----|------|
| 18028-25 | 25  | ●    |
| 18028-30 | 30  | ●    |
| 18028-36 | 36  | ●    |



**Bread knife**

Coltello pane  
Brotmesser  
Couteau à pain  
Cuchillo para pan

| art.     | cm. | col. |
|----------|-----|------|
| 18028B30 | 30  | ●    |



**Bread knife**

Coltello pane  
Brotmesser  
Couteau à pain  
Cuchillo para pan

| art.     | cm. | col. |
|----------|-----|------|
| 18028M25 | 25  | ●    |



**Bread knife**

Coltello pane  
Brotmesser  
Couteau à pain  
Cuchillo para pan

| art.     | cm. | col. |
|----------|-----|------|
| 18028W21 | 21  | ○    |
| 18028W25 | 25  | ○    |
| 18028W30 | 30  | ○    |
| 18028W36 | 36  | ○    |



**Bread knife**

Coltello pane  
Brotmesser  
Couteau à pain  
Cuchillo para pan

| art.     | cm. | col. |
|----------|-----|------|
| 18028Y25 | 25  | ●    |
| 18028Y30 | 30  | ●    |



**Universal knife, wavy edge**

Coltello universale, seghettato  
Universalmesser mit Wellenschliff  
Couteau universel, lame dentelée  
Cuchillo universal serrado

| art.     | cm. | col. |
|----------|-----|------|
| 18029-25 | 25  | ●    |



**Cake knife**

Coltello dolce  
Bäckermesser  
Couteau de pâtissier  
Cuchillo para pastelería

| art.     | cm. | col. |
|----------|-----|------|
| 18030-26 | 26  | ●    |
| 18030-31 | 31  | ●    |
| 18030-36 | 36  | ●    |



**Cake knife**

Coltello dolce  
Bäckermesser  
Couteau de pâtissier  
Cuchillo para pastelería

| art.     | cm. | col. |
|----------|-----|------|
| 18030W26 | 26  | ○    |
| 18030W31 | 31  | ○    |
| 18030W36 | 36  | ○    |





**Slicer, chinese style**

Falcetta cinese  
Kochmesser, chinesische Form  
Couteau de cuisine, style chinois  
Cuchillo cocina, estilo chino

| art.     | cm. | col. |
|----------|-----|------|
| 18221-17 | 17  | ●    |
| 18221-19 | 19  | ●    |
| 18221-21 | 21  | ●    |



**Slicer, chinese style**

Falcetta cinese  
Kochmesser, chinesische Form  
Couteau de cuisine, style chinois  
Cuchillo cocina, estilo chino

| art.     | cm. | col. |
|----------|-----|------|
| 18221B17 | 17  | ●    |
| 18221B19 | 19  | ●    |
| 18221B21 | 21  | ●    |



**Slicer, chinese style**

Falcetta cinese  
Kochmesser, chinesische Form  
Couteau de cuisine, style chinois  
Cuchillo cocina, estilo chino

| art.     | cm. | col. |
|----------|-----|------|
| 18221G17 | 17  | ●    |
| 18221G19 | 19  | ●    |
| 18221G21 | 21  | ●    |



**Slicer, chinese style**

Falcetta cinese  
Kochmesser, chinesische Form  
Couteau de cuisine, style chinois  
Cuchillo cocina, estilo chino

| art.     | cm. | col. |
|----------|-----|------|
| 18221M17 | 17  | ●    |
| 18221M19 | 19  | ●    |
| 18221M21 | 21  | ●    |



**Slicer, chinese style**

Falcetta cinese  
Kochmesser, chinesische Form  
Couteau de cuisine, style chinois  
Cuchillo cocina, estilo chino

| art.     | cm. | col. |
|----------|-----|------|
| 18221R17 | 17  | ●    |
| 18221R19 | 19  | ●    |
| 18221R21 | 21  | ●    |



**Slicer, chinese style**

Falcetta cinese  
Kochmesser, chinesische Form  
Couteau de cuisine, style chinois  
Cuchillo cocina, estilo chino

| art.     | cm. | col. |
|----------|-----|------|
| 18221Y17 | 17  | ●    |
| 18221Y19 | 19  | ●    |
| 18221Y21 | 21  | ●    |



**Meat cleaver**

Falcetta macellaio  
Hackmesser  
Couperet  
Hacha de carnicero

| art.     | cm. | Kg.  | col. |
|----------|-----|------|------|
| 18220-18 | 18  | 0,55 | ●    |
| 18220-20 | 20  | 1,10 | ●    |
| 18220-22 | 22  | 1,30 | ●    |
| 18220-26 | 26  | 1,30 | ●    |



**Meat cleaver**

Falcetta macellaio  
Hackmesser  
Couperet  
Hacha de carnicero

| art.     | cm. | Kg.  | col. |
|----------|-----|------|------|
| 18220B18 | 18  | 0,55 | ●    |
| 18220B20 | 20  | 1,10 | ●    |
| 18220B22 | 22  | 1,30 | ●    |
| 18220B26 | 18  | 0,55 | ●    |





**Meat cleaver**  
Falchetta macellaio  
Hackmesser  
Couperet  
Hacha de carnicero

| art.     | cm. | Kg.  | col. |
|----------|-----|------|------|
| 18220R18 | 20  | 1,10 | ●    |
| 18220R20 | 22  | 1,30 | ●    |
| 18220R22 | 18  | 0,55 | ●    |
| 18220R26 | 20  | 1,10 | ●    |



**Meat cleaver**  
Falchetta macellaio  
Hackmesser  
Couperet  
Hacha de carnicero

| art.     | cm. | Kg.  | col. |
|----------|-----|------|------|
| 18220Y18 | 22  | 1,30 | ●    |
| 18220Y20 | 18  | 0,55 | ●    |
| 18220Y22 | 20  | 1,10 | ●    |
| 18220Y26 | 22  | 1,30 | ●    |



**Bone splitter**  
Mezzo colpo  
Kochschlagmesser  
Couteau de cuisine lourd  
Cuchillo cocina pesado

| art.     | cm. | Kg.  | col. |
|----------|-----|------|------|
| 18224-28 | 28  | 0,75 | ●    |
| 18224B28 | 28  | 0,75 | ●    |
| 18224R28 | 28  | 0,75 | ●    |
| 18224Y28 | 28  | 0,75 | ●    |



**Bone splitter**  
Colpo  
Kochschlagmesser  
Couteau de cuisine lourd  
Cuchillo cocina pesado

| art.     | cm. | Kg. | col. |
|----------|-----|-----|------|
| 18225-28 | 28  | 1   | ●    |
| 18225R28 | 28  | 1   | ●    |



**Parmesan knife**  
Grana  
Parmesanmesser  
Couteau à Parmesan  
Cuchillo para queso

| art.     | cm. | col. |
|----------|-----|------|
| 18205-10 | 10  | ●    |



**Parmesan knife**  
Grana  
Parmesanmesser  
Couteau à Parmesan  
Cuchillo para queso

| art.     | cm. | col. |
|----------|-----|------|
| 18205-12 | 12  | ●    |



**Cheese knife**  
Coltello segnaforme  
Käsemesser  
Couteau à fromage  
Cuchillo para queso

| art.     | cm. | col. |
|----------|-----|------|
| 18206-09 | 9   | ●    |



**Cheese knife**  
Coltello lancia "Milano"  
Käsemesser  
Couteau à fromage  
Cuchillo para queso

| art.     | cm. | col. |
|----------|-----|------|
| 18207-15 | 15  | ●    |



**Oyster knife**  
Coltello apriostriche  
Austernmesser  
Couteau à huîtres  
Cuchillo ostras

| art.     | cm. | col. |
|----------|-----|------|
| 18209-06 | 15  | ●    |



**Cheese knife**  
Coltello formaggio  
Käsemesser  
Couteau à fromage  
Cuchillo queso

| art.     | cm. | col. |
|----------|-----|------|
| 18201-36 | 36  | ●    |





**Vegetables knife**

Coltello verdure  
Gemüsemesser  
Couteau à crudités  
Cuchillo verduras

| art.     | cm. | col. |
|----------|-----|------|
| 18222-18 | 18  | ●    |



**Ham boner**

Cannula disosso prosciutti  
Schinkenauslöser  
Gouge à jambons  
Cuchillo deshuesar jamón

| art.     | cm. | col. |
|----------|-----|------|
| 48021-21 | 21  | ●    |



**Cheese knife**

Coltello formaggio  
Käsemesser  
Couteau à fromage  
Cuchillo para queso

| art.     | cm. | col. |
|----------|-----|------|
| 18203-26 | 26  | ●    |



**Baking pan knife**

Coltello gastronomia  
Winkelmesser  
Couteau à gastronomie  
Cuchillo gastronomía

| art.     | cm.  | col. |
|----------|------|------|
| 18215-13 | 13,5 | ●    |



**Baking pan knife**

Coltello gastronomia  
Winkelmesser  
Couteau à gastronomie  
Cuchillo gastronomía

| art.     | cm.  | col. |
|----------|------|------|
| 18215-21 | 21,5 | ●    |



**Farinata knife**

Coltello per farinata  
Farinata Messer  
Couteau à Farinata  
Cuchillo Farinata

| art.     | cm. | col. |
|----------|-----|------|
| 42830-08 | 8   | ●    |



**Pie knife**

Coltello torta  
Tortenmesser  
Couteau à gâteau  
Cuchillo para tartas

| art.     | cm. | col. |
|----------|-----|------|
| 18514-18 | 18  | ●    |



**Mincing knife**

Mezzaluna  
Wiegemesser  
Hachoir  
Media luna

| art.     | cm. | col. |
|----------|-----|------|
| 48017-14 | 14  | ●    |
| 48017-25 | 26  | ●    |



**Double blade mincing knife**

Mezzaluna, lama doppia  
Wiegemesser, Doppel-Klinge  
Hachoir double lame

Media luna, doble

| art.     | cm. | col. |
|----------|-----|------|
| 48215-14 | 14  | ●    |
| 48215-30 | 30  | ●    |



**Meat fork**

Forchettone  
Fleischgabel  
Fourchette diapason  
Tenedor para carne

| art.     | cm. | col. |
|----------|-----|------|
| 18226-17 | 17  | ●    |
| 18226B17 | 17  | ●    |
| 18226G17 | 17  | ●    |



**Meat fork**

Forchettone  
Fleischgabel  
Fourchette diapason  
Tenedor para carne

| art.     | cm. | col. |
|----------|-----|------|
| 18226R17 | 17  | ●    |
| 18226W17 | 17  | ○    |
| 18226Y17 | 17  | ●    |



**Sharpening steel**

Acciaino  
Wetzstahl  
Fusil à affûter  
Afilador

| art.     | cm. | col. |
|----------|-----|------|
| 18235-26 | 26  | ●    |



**Sharpening steel**

Acciaino  
Wetzstahl  
Fusil à affûter  
Afilador

| art.     | cm. | col. |
|----------|-----|------|
| 18235-30 | 30  | ●    |
| 18235B30 | 30  | ●    |
| 18235G30 | 30  | ●    |



**Sharpening steel**

Acciaino  
Wetzstahl  
Fusil à affûter  
Afilador

| art.     | cm. | col. |
|----------|-----|------|
| 18235R30 | 30  | ●    |
| 18235W30 | 30  | ○    |
| 18235Y30 | 30  | ●    |



**Oval sharpening steel**

Acciaino ovale  
Wetzstahl, oval  
Fusil à affûter, ovale  
Afilador ovalado

| art.     | cm. | col. |
|----------|-----|------|
| 18236-30 | 30  | ●    |



**Diamond sharpening steel**

Acciaino diamantato  
Diamant-Wetzstahl  
Fusil à affûter, diamant  
Afilador adiamantado

| art.     | cm. | col. |
|----------|-----|------|
| 18237-26 | 26  | ●    |



**Sharpening stone GRIT 1000/240**

Pietra per affilare  
Abziehstein  
Pierre à aiguïser  
Piedra para afilar

| art.     | cm.    |
|----------|--------|
| 18251-01 | 21x7x3 |



**Sharpening stone GRIT 1000/600**

Pietra per affilare  
Abziehstein  
Pierre à aiguïser  
Piedra para afilar

| art.     | cm.    |
|----------|--------|
| 18251-02 | 21x7x3 |





**Poultry shears**

Trinciapollo  
Geflügelschere  
Coupe volailles  
Tijeras para ave

art. cm.  
18263-00 25



**Poultry scissors, divisible**

Forbice pollame, smontabile  
Geflügelschere, teilbar  
Ciseaux à volaille, divisible  
Tijeras para aves, desmontables

art. cm.  
18275-00 26,5



**Poultry shears, divisible**

Trinciapollo, smontabile  
Geflügelschere, teilbar  
Coupe volailles, divisible  
Tijeras para aves, desmontables

art. cm.  
18261-00 24



**Seafood scissors**

Forbice per gamberi  
Meeresfrüchteschere  
Ciseaux à crevettes  
Tijeras para camarones

art. cm.  
18278-00 18



**Herb scissors, 5 blades**

Forbice per erbe, 5 lame  
Kräuterschere  
Ciseaux à herbes  
Tijeras hierbas

art. cm.  
18277-00 20



**Salad scissors**

Forbice insalata  
Salatschere  
Ciseaux à salade  
Tijeras para ensalada

art. cm.  
18270-22 22



**Quail egg cutter**

Forbice per uova di quaglia  
Wachteleier-Schere  
Ciseaux oeufs de caille  
Tijeras huevos de codorniz

art. cm.  
18279-14 14





**Kitchen scissors**

Forbice multiuso  
Küchenschere  
Ciseaux cuisine  
Tijeras de cocina, multiuso

art. cm.  
18272-00 18,5



**Divisible kitchen scissors**

Forbice da cucina, smontabile  
Küchenschere, teilbar  
Ciseaux cuisine, divisible  
Tijeras de cocina, desmontables

art. cm.  
18271-00 22,6



**Divisible kitchen scissors**

Forbice da cucina, smontabile  
Küchenschere, teilbar  
Ciseaux cuisine, divisible  
Tijeras de cocina, desmontables

art. cm.  
18273-00 18



**Divisible kitchen scissors**

Forbice da cucina, smontabile  
Küchenschere, teilbar  
Ciseaux cuisine, divisible  
Tijeras de cocina, desmontables

art. cm.  
18274-00 20



**Chinese kitchen scissors**

Forbici cucina cinesi  
Chinesische Küchenschere  
Ciseaux de cuisine chinois

art. cm.  
49636-00 17x8,5

**Stainless steel and brass. – Inox e ottone.**



**Divisible pizza scissors**

Forbice pizza, smontabile  
Pizzaschere, teilbar  
Ciseaux pizza, divisible  
Tijeras para pizza, desmontables

art. cm.  
18276-00 25



# JAPANESE SUSHI KNIVES COLTELLI SUSHI GIAPPONESI

KNIVES  
COLTELLERIA

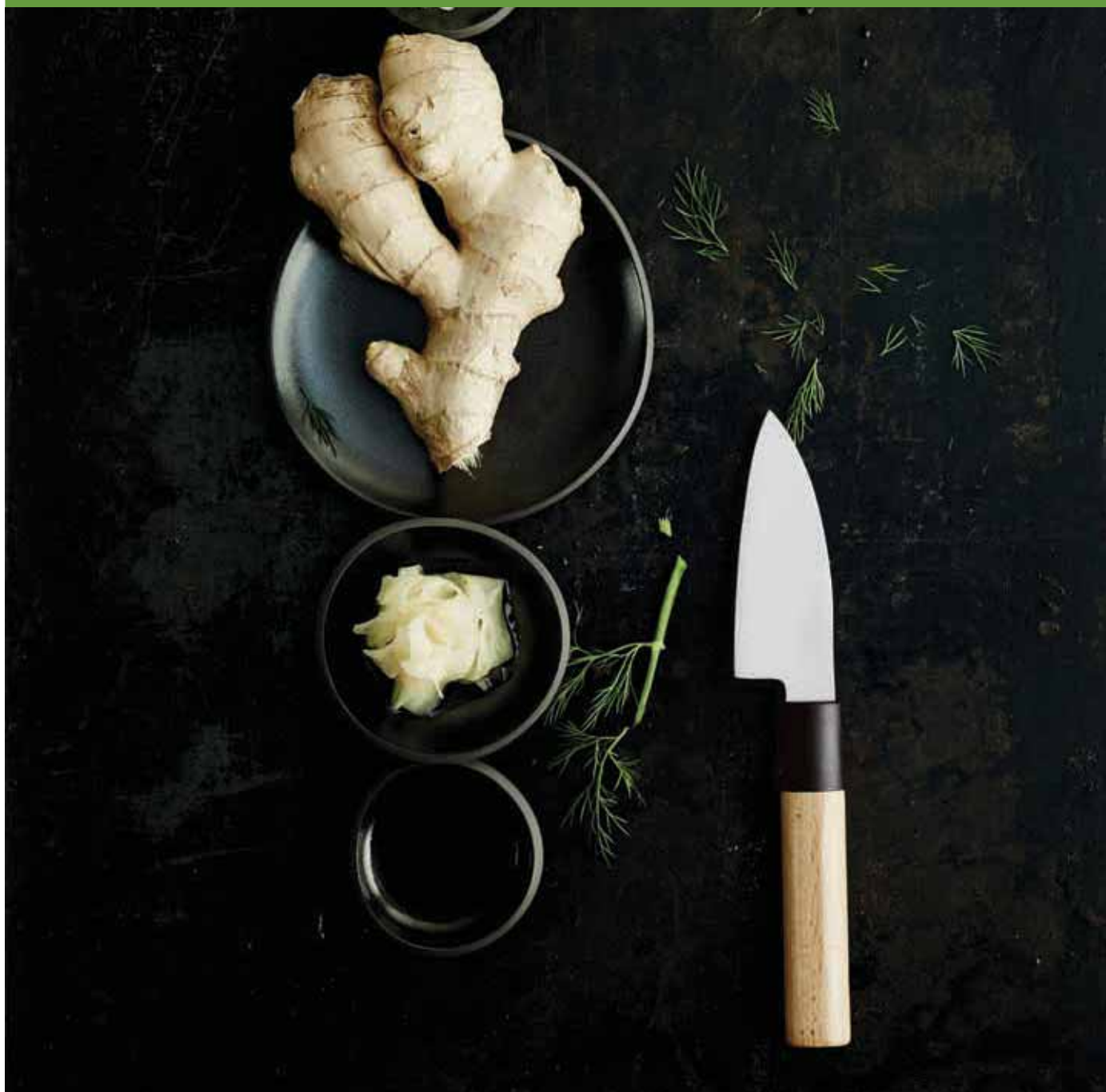

Excellent choice when preparing sushi and vegetables. Molybdenum/Vanadium s/s blades for excellent edge retention, razor sharp edges, slip resistant wooden handles. The blades are sharpened with the traditional Japanese single bevel to improve sharpness. The large beveled one-sided edge is much thinner than a two-sided edge. This thinner, sharper edge makes for cleaner cuts through the soft flesh of fish, in particular. Using these knives will avoid bruising the delicate texture of raw fish and destroying the freshness of the fish. The thinner edge is more fragile than the edge on western knives. Do not use for cutting anything solid including larger fish bones. Due to the special blade sharpening and s/s used we highly recommend to only hand wash and dry the blades thoroughly immediately.

Una scelta eccellente per la preparazione di sushi e verdure. Lame in acciaio inox, molibdeno e vanadio, per un'ottimale tenuta del filo, affilatura a rasoio, manici in legno antiscivolo. Secondo la tradizione giapponese l'affilatura è unilaterale ed il filo è molto più sottile rispetto a quello della normale affilatura dei coltelli occidentali. Questo rende i tagli più nitidi ed evita di creare traumi alla trama delicata di carne e pesce crudo. Non utilizzare per il taglio di solidi incluse grosse lisce di pesce. Data la particolarità dell'affilatura e dell'acciaio impiegato si consiglia vivamente di lavare a mano ed asciugare immediatamente con cura le lame.



DEBA

| art.     | l. cm. |
|----------|--------|
| 18280-22 | 22,5   |
| 18280-16 | 16,5   |
| 18280-10 | 10,5   |

The Deba is a powerful knife used for filleting fish and butchering meat without bones. Its weight and thickness can chop through fish bones and the sharp edge can fillet even the smallest of fish. – Affilato e dalla lama pesante usato per disossare e tagliare il pesce utilizzato nel sushi. È simile ad un coltello da chef.



OROSHI

| art.     | l. cm. |
|----------|--------|
| 18281-24 | 24     |

An Oroshi Knife is a Japanese all-purpose cooking knife, but used particularly for fish. – Per sfilettare il tonno e altri pesci di grandi dimensioni.



USUBA

| art.      | l. cm. |
|-----------|--------|
| 18282-22  | 22,5   |
| 18282-18  | 18,0   |
| 18282-19* | 18,0   |

\*Double bevel. The Usuba is the ultimate vegetable knife. Sharp and thin, it is used by chefs in Japan for katsuramuki, a traditional style of peeling vegetables into thin sheets. – \*Doppia affilatura. Coltello estremamente affilato con una punta quadrata. Questo coltello è usato per tagliare verdure e quando è tenuto ben affilato può tagliarle in fette sottili come un foglio di carta.



TAKO SASHIMI

| art.     | l. cm. |
|----------|--------|
| 18283-33 | 33     |
| 18283-27 | 27     |

The Tako Sashimi is a variation of the Yanagi and is used to slice straight-cut sashimi. The blunt tip and balanced weight works well on difficult ingredients like octopus, from which it gets its name. Originated in Kanto (Tokyo) region. – Il coltello Tako Sashimi assomiglia di più ad un coltello occidentale ed è utilizzato per affettare tagli spessi di carne per sushi. Ha la lama senza punta, per evitare di rovinare i tentacoli del polpo.



YANAGI SASHIMI

| art.     | l. cm. |
|----------|--------|
| 18284-21 | 21     |
| 18284-27 | 27     |
| 18284-30 | 30     |
| 18284-33 | 33     |

The Yanagi Sashimi is a slicing knife used to cut boneless fish fillets into sashimi and topping for sushi. The graceful, thin blade cuts beautiful slices in one long, drawing stroke. Originated in Kansai (Osaka) region. – Viene utilizzato per tagliare sottili fette di verdure, carne o pesce, nonché per tagliare in generale a dadi o a fette. Grazie alla sua lama sottile ed affilata è utilizzato anche per creare guarnizioni o tagliare i rotoli di sushi.



**Chef's set, 14 pieces**

Valigia cuoco, 14 pz.  
Kochkoffer, 14 Stk.  
Mallette de chef, 14 pièces  
Maleta del Chef, 14 piezas

| art.     | des.                           |
|----------|--------------------------------|
| 18099-15 | Comprende/includes:            |
| 18000-26 | cook's knife/cucina cm 26      |
| 18000-30 | cook's knife/cucina cm 30      |
| 18002-18 | butcher's knife/francese cm 18 |
| 18002-26 | butcher's knife/francese cm 26 |
| 18009-30 | ham/prosciutto cm 30           |
| 18016-16 | boning/disosso cm 6            |
| 18024-11 | paring/spelucchino cm 11       |
| 18026-07 | paring/spelucchino cm 7        |
| 18028-30 | bread/pane cm 30               |
| 18230-17 | fork/forchettone cm 17         |
| 18235-30 | sharpener/acciaino cm 30       |
| 18519-26 | spatula/spatola cm 26          |
| 48280-34 | peeler/pelapatate              |
| 18276-00 | scissors/forbice pizza         |

**Chef's set, 17 pcs**

Valigia cuoco, 17 pz.  
Kochkoffer, 17 Stk.,  
Mallette de chef, 17 pcs  
Maleta del Chef, 17 piezas

| art.     | des.                         |
|----------|------------------------------|
| 18199-19 | Comprende/includes:          |
| 18100-24 | cook's knife/cucina cm 24    |
| 18100-30 | cook's knife/cucina cm 30    |
| 18112-30 | salmon/salmone cm 30         |
| 18115-20 | filetting/filettare cm 20    |
| 18116-14 | boning/disosso cm 14         |
| 18125-10 | paring/spelucchino cm 10     |
| 18126-07 | bent paring/spelucchino cm 7 |
| 18128-30 | bread/pane cm 30             |
| 18230-17 | fork/forchettone cm 17       |
| 18235-30 | sharpener/acciaino cm 30     |
| 18276-00 | scissors/forbice pizza       |
| 18255-00 | sharpener/affila coltelli    |
| 48280-25 | apple corer/levatorsoli      |
| 48280-34 | peeler/pelapatate            |
| 48280-02 | can opener/apribottiglie     |
| 48280-27 | melon baller/scavino         |
| 48280-92 | striper/decora limoni        |







**Knife roll-bag, 9 pieces forged**

Rotolo portacoltelli, 9 pz. forgiati

Rolltasche, 9-teilig

Rouleau à couteaux, 9 pièces

Bolsa porta cuchillos, 9 piezas

| art.     | des.                   |
|----------|------------------------|
| 18190-09 | Comprende/includes:    |
| 18116-14 | boning/disosso cm 9    |
| 18100-24 | cook's/cucina cm 24    |
| 18106-25 | slicer/affettare cm 25 |
| 18109-26 | ham/prosciutto cm 24   |



| art.     | des.               |
|----------|--------------------|
| 18124-09 | paring/spelucchino |
| 18128-24 | bread/pane cm 14   |
| 18230-17 | fork/forchettone   |
| 18235-26 | sharpener/acciaino |
| 18271-00 | scissors/forbice   |



**Wood knife block, 9 pcs set**

Ceppo porta coltelli legno, set 9 pz

Holz-Messerblock, 9-tlg.

Bloc à couteaux en bois, set 9 pièces

Bloque portacuchillos de madera, 9 piezas

| art.     | des.                    |
|----------|-------------------------|
| 18192-09 | Comprende/includes:     |
| 18100-20 | cook's/cucina cm 20     |
| 18106-20 | slicer/affettare cm 20  |
| 18124-09 | paring/spelucchino cm 9 |
| 18128-20 | bread/pane cm 20        |



| art.     | des.                     |
|----------|--------------------------|
| 18230-17 | fork/forchettone cm 17   |
| 18235-26 | sharpener/acciaino cm 26 |
| 18271-00 | scissors/forbice         |
| 18102-16 | butcher's/francese cm 16 |
| 18126-07 | paring/cuoco cm 7        |



**Knife block, silicone**

Ceppo porta coltelli, silicone

Messerblock, Silikon

Bloc à couteaux, silicone

Bloque portacuchillos, silicona

| art.     | Ø cm. | h. cm. |
|----------|-------|--------|
| 18191-22 | 10,5  | 22,5   |





**Magnetic knife rack**

Barra magnetica  
Magnet-Messerhalter  
Porte-couteaux magnetique  
Barra magnética portas cuchillos

| art.     | cm. |
|----------|-----|
| 48032-30 | 30  |
| 48032-45 | 45  |
| 48032-60 | 60  |



SS

**E**dlund

**Knife block**

Ceppo porta coltelli  
Messerblock  
Bloc à couteaux  
Bloque portacuchillos

| art.     | cm.      |
|----------|----------|
| 49875-06 | 26x14x33 |



SS

**E**dlund

**Knife rack**

Porta coltelli  
Messeraufhänger  
Support à couteaux  
Porta cuchillos

| art.     | cm.           |
|----------|---------------|
| 48040-00 | 30,5x6,6x30,5 |
| 48040-AA |               |

**Holds 8 chef 's knives, 2 smaller knives, 1 steel and scissors.** – Per 8 coltelli cuoco, 2 coltelli piccoli, 1 acciaio e forbici.



SS

**E**dlund

**Knife rack**

Porta coltelli  
Messeraufhänger  
Support à couteaux  
Porta cuchillos

| art.     | cm.           |
|----------|---------------|
| 48040-10 | 30,5x6,6x35,6 |
| 48040-AA |               |

**Holds 8 chef 's knives, 2 smaller knives, 1 steel and scissors.** – Per 8 coltelli cuoco, 2 coltelli piccoli, 1 acciaio e forbici.



SS

**E**dlund

**Knife rack**

Porta coltelli  
Messeraufhänger  
Support à couteaux  
Porta cuchillos

| art.     | cm.           |
|----------|---------------|
| 48039-06 | 15,2x6,6x30,5 |

**Holds 1 cleaver and 4 chef knives or 6 chef knives or 8 slicers or 12 paring knives and 1 round or diamond steel.** – Per 1 mannaia e 4 coltelli cuoco o 6 coltelli cuoco o 8 coltelli affettare o 12 spelucchini e 1 acciaio tondo.



SS

**E**dlund

**Knife sanitizing system**

Sterilizzatore ad immersione  
Messerentkeimer  
Stérilisateur à couteaux  
Esterilizador a inmersión

| art.     | cm.            |
|----------|----------------|
| 48040-50 | 45,7x11,5x45,7 |



**Manual sharpener**

Affilacoltelli manuale  
Messer Schleifapparat  
Affûteur manuel  
Afilador manual

| art.     |
|----------|
| 18255-00 |



**Manual sharpener**

Affilacoltelli manuale  
Messer Schleifapparat  
Affûteur manuel  
Afilador manual

| art.     |
|----------|
| 49739-00 |

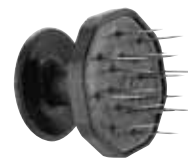

**Salami pricker**

Pungisalame  
Salamistachel  
Pique saucisson  
Picadura pra embutido

| art.     |
|----------|
| 42523-00 |



SS

**Larding needle, with flap**

Ago lardellare, con becco  
Spicknadel, mit Klappe  
Lardoire à clapet  
Aguja con clip

| art.     | Ø mm. | cm. |
|----------|-------|-----|
| 42514-20 | 5     | 20  |



SS

**Lacing needle, straight**

Ago da cucina  
Dressiernadel, gerade  
Aiguille à brider, droite  
Aguja de cocina

| art.     | cm. |
|----------|-----|
| 42515-18 | 18  |
| 42515-20 | 20  |



SS

**Lacing needle, bent**

Ago da cucina, curvo  
Dressiernadel, gebogen  
Aiguille à brider, courbe  
Aguja de cocina

| art.     | cm. |
|----------|-----|
| 42516-18 | 18  |
| 42516-20 | 20  |



SS

**Needles 5 pcs set**

Aghi set 5 pz  
Nadelsatz, 5 Stk.  
Aiguilles set 5 pcs  
Agujas 5 pz

| art.     |
|----------|
| 42517-06 |



W

**Skewers, 100 pcs**

Spiedini, 100 pz  
Fleischspieße, 100 Stk  
Brochettes, 100 pcs  
Palos para asar, 100 pz

| art.     | cm. |
|----------|-----|
| 48307-01 | 15  |
| 48307-02 | 20  |
| 48307-03 | 25  |



SS

**Skewers 6 pcs set**

Spiedini set 6 pz  
Fleischspieße, Satz 6 Stk  
Brochettes set 6 pcs  
Palos para asar 6 pz

| art.     | cm. |
|----------|-----|
| 42529-06 | 30  |



**Skewers flat, 18/8**

Spiedini piatti, 18/8  
Fleischspieße, flach, 18/8  
Brochettes plates, 18/8  
Pinchos planos, 18/8

| art.     | mm.   | U. Pack |
|----------|-------|---------|
| 42511-20 | 200x3 | 10      |
| 42511-25 | 250x3 | 10      |
| 42511-30 | 300x3 | 10      |
| 42511-35 | 350x3 | 10      |
| 42511-40 | 400x3 | 10      |
| 42511-56 | 560x5 | 10      |



**Swords, 18/8**

Spade, 18/8  
Schwerter, 18/8  
Epées, 18/8  
Espadas, 18/8

| art.     | mm.      |
|----------|----------|
| 42511-60 | 600x15x3 |
| 42511-70 | 700x15x3 |



SS

**Anchor meat hook**

Gancio ad ancora  
Anker Fleischhaken  
Esse à ancre  
Gancho forma ancla

| art.     | Ø mm. | cm. | U. Pack |
|----------|-------|-----|---------|
| 42507-12 | 7     | 13  | 10      |



SS

**Sliving meat hook**

Gancio girevole  
Fleischdrehhaken  
Esse-tournante  
Gancho giratorio

| art.     | Ø mm. | cm. | U. Pack |
|----------|-------|-----|---------|
| 42525-27 | 12    | 27  | 10      |



SS

**Meat hook, 2 peacks**

Gancio fisso, 2 punte  
Fleischhaken, 2 Spitze  
Crochet esse, 2 pointes  
Gancho 2 puntas

| art.     | Ø mm. | cm. | U. Pack |
|----------|-------|-----|---------|
| 42524-06 | 3     | 6   | 10      |
| 42524-08 | 4     | 8   | 10      |
| 42524-10 | 4     | 10  | 10      |
| 42524-12 | 5     | 12  | 10      |
| 42524-14 | 5     | 14  | 10      |
| 42524-16 | 6     | 16  | 10      |
| 42524-18 | 6     | 18  | 10      |
| 42524-20 | 9     | 20  | 10      |
| 42524-22 | 9     | 22  | 10      |
| 42524-30 | 12    | 30  | 10      |



SS

**Meat hook, 1 peack**

Gancio fisso, 1 punta  
Fleischhaken, 1 Spitze  
Crochet esse, 1 pointe  
Gancho 1 punta

| art.     | Ø mm. | cm. | U. Pack |
|----------|-------|-----|---------|
| 42506-08 | 3     | 8   | 10      |
| 42506-10 | 4     | 10  | 10      |
| 42506-12 | 5     | 12  | 10      |
| 42506-14 | 5     | 14  | 10      |
| 42506-16 | 6     | 16  | 10      |
| 42506-18 | 6     | 18  | 10      |



SS

**Swivel meat hook**

Gancio girevole  
Fleischdrehhaken  
Esse-tournante  
Gancho giratorio

| art.     | Ø mm. | cm. |
|----------|-------|-----|
| 42505-21 | 9     | 22  |
| 42505-24 | 10    | 26  |
| 42505-27 | 12    | 28  |
| 42505-50 | 12    | 50  |



SS

**Sliding meat hook**

Gancio scorrevole  
Fleischhaken  
Crochet coulissant  
Gancho

| art.     | Ø mm. | cm. | U. Pack |
|----------|-------|-----|---------|
| 42526-12 | 9     | 12  | 10      |
| 42526-14 | 12    | 14  | 10      |



SS

**Ham-tong**

Pinza per affettati  
Schinkenzange  
Pince à jambon  
Pinza para jamón

| art.     | cm.  |
|----------|------|
| 42510-00 | 11x6 |



SS

**Meat tenderizer**

Batticarne a pugno  
Kotelettklopfer  
Aplatisseur  
Aplasta carnes

| art.     | Kg. |
|----------|-----|
| 42501-15 | 1,5 |
| 42501-20 | 2,0 |



SS

**Meat tenderizer**

Batticarne a due tagli  
Kotelettklopfer  
Aplatisseur  
Aplasta carnes

| art.     | Kg. |
|----------|-----|
| 42502-11 | 1,1 |



SS

**Meat tenderizer**

Batticarne a paletta  
Kotelettklopfer  
Aplatisseur  
Aplasta carnes

| art.     | Kg. |
|----------|-----|
| 42503-10 | 1   |



**Steak hammer, aluminum**

Batticarne, alluminio  
Aluminum-Fleischklopfen  
Attendrisseur, alu  
Aplasta carnes, aluminio

| art.     | cm. | Kg. |
|----------|-----|-----|
| 42508-00 | 32  | 0,6 |



**Steak hammer, aluminum**

Batticarne, alluminio  
Aluminum-Fleischklopfen  
Attendrisseur, alu  
Aplasta carnes, aluminio

| art.     | cm. | Kg.  |
|----------|-----|------|
| 42508-01 | 25  | 0,41 |



SS

**Bone-saw**

Sega per ossa  
Knochensäge  
Scie à os  
Sierra de cocina

| art.     | cm. |
|----------|-----|
| 48231-40 | 40  |
| 48231-45 | 45  |
| 48231-50 | 50  |



SS

**String holder**

Portaspago  
Schnurrolle-Halter  
Porte rolls sur socle  
Porta cuerda

| art.     | cm.      |
|----------|----------|
| 42579-00 | 19x12x17 |



SS

**Meat pan**

Vassoio rettangolare  
Fleischblech  
Plat boucher  
Bandeja rectangular

| art.     | cm.     |
|----------|---------|
| 42534-26 | 26x23x2 |
| 42534-32 | 34x21x2 |
| 42534-41 | 45x25x2 |



SS

**Display tray**

Vassoio espositore  
Ausstellplatte  
Plateau  
Bandeja expositora

| art.     | cm.     |
|----------|---------|
| 42532-29 | 29x21x2 |
| 42532-58 | 58x21x2 |



SS

**Meat pan**

Vassoio  
Fleischblech  
Plat boucher  
Contenedor

| art.     | cm.           |
|----------|---------------|
| 42530-26 | 24,4x21,6x5,5 |
| 42530-32 | 32x23x5,5     |
| 42530-41 | 41x31x5,5     |
| 42530-50 | 50x35x5,5     |



SS

**Meat pan with grid**

Vassoio con griglia  
Fleischblech mit Siebeinsatz  
Plat boucher avec grille  
Contenedor con rejilla

| art.     | cm.           |
|----------|---------------|
| 42531-26 | 24,4x21,6x5,5 |
| 42531-32 | 32x23x5,5     |
| 42531-41 | 41x31x5,5     |
| 42531-50 | 50x35x5,5     |



**Ham stand on wood**

Ferma prosciutto base legno  
Schinkenhalter, Holzsockel  
Pince à jambon sur bois  
Jamonero, base madera

| art.     | cm.      | Kg. |
|----------|----------|-----|
| 41582-00 | 24x45x16 | 4,5 |



**Ham stand on marble**

Ferma prosciutto base marmo  
Schinkenhalter, Marmorsockel  
Pince à jambon sur marbre  
Jamonero, base mármol

| art.     | cm.      | Kg.  |
|----------|----------|------|
| 41583-00 | 24x45x15 | 10,3 |



SS

**Hamburger press**

Pressa-hamburger  
Hamburgerpresse  
Moule à steak  
Prensa para hamburguesa

| art.     | Ø cm. | l. cm. |
|----------|-------|--------|
| 42864-10 | 10    | 36     |



**Hamburger press, anodized aluminum**

Pressa-hamburger, alluminio anodizzato  
Hamburgerpresse, Aluminium eloxiert  
Moule à steak, aluminium anodisé  
Prensa para hamburguesa, aluminio anodizado

| art.     | cm.        | Kg. |
|----------|------------|-----|
| 49978-10 | 37x25x50   | 5,0 |
| 49978-13 | 42x27,5x53 | 5,5 |

**The parts coming into contact with food are in stainless steel. – Parti a contatto con il cibo in acciaio inox per alimenti.**



**Vertical manual sausage filler**

Insaccatrice verticale  
Wurstfüller  
Poussoir manuel vertical  
Ensacadora vertical

| art.     | cm.        | lt. | Kg. |
|----------|------------|-----|-----|
| 49876-03 | 30x22x47,5 | 3   | 6,2 |

**With 3 funnels. – Con 3 imbuti.**



**Slicer**

Affettatrice  
Aufschnitt-Maschine  
Trancheur  
Cortadora

| art.     | Ø cm. | cm.      | Kg. |
|----------|-------|----------|-----|
| 49971-25 | 25    | 68x52x51 | 33  |

**Cut thickness range mm 0÷2,3. 9 cutting positions. Cut cm 18,5x51. – Spessore taglio mm. 0÷2,3. 8 scatti. Taglio utile cm 18,5x15.**



**Slicer**

Affettatrice  
Aufschnitt-Maschine  
Trancheur  
Cortadora

| art.     | Ø cm. | cm.      | Kg.  |
|----------|-------|----------|------|
| 49972-30 | 30    | 72x60x74 | 45,5 |

**Cut thickness range mm 0÷2,5. 9 cutting positions. Cut cm 23x19. – Spessore taglio mm. 0÷2,5. 9 scatti. Taglio utile cm 23x19.**



**Slicer**

Affettatrice  
Aufschnitt-Maschine  
Trancheur  
Cortadora

| art.     | Ø cm. | des.  |
|----------|-------|-------|
| 49971R25 | 25    | Rose  |
| 49971M25 | 25    | Daisy |
| 49972R30 | 30    | Rose  |
| 49972M30 | 30    | Daisy |



**Stand**

Piedistallo  
Sockel  
Piédestal  
Pedestal

| art.     | cm.   |
|----------|-------|
| 49971P25 | 65x80 |
| 49972P30 | 65x80 |



**Stand with wheels**

Piedistallo con ruote  
Sockel mit Rädern  
Piédestal avec roues  
Pedestal con ruedas

| art.     | cm.   |
|----------|-------|
| 49971R00 | 65x80 |



**Block brush, plastic handle**  
Spazzola per ceppa  
Blockbürste, Kunststoffgriff  
Brosse à billot, matière plastique  
Cepillo para cepa

| art.     | cm. |
|----------|-----|
| 42518-01 | 20  |



PE

**Cutting board with tray**  
Tagliere con vasca  
Tranchierbrett mit Tablett  
Planche à découper avec plateau  
Tabla de corte con bandeja

| art.     | cm.         |
|----------|-------------|
| 44947-00 | 33,5x46x5,5 |



HDPE

**Cutting board**  
Tagliere bar  
Tranchierbrett  
Planche à découper  
Tabla de corte

| art.     | cm.         |
|----------|-------------|
| 42521-16 | 16x24,5x1   |
| 42521-24 | 24,5x32,5x1 |



03 = RED / ROSSO  
Raw meat and poultry  
Carni crude  
Rohes Fleisch  
Viande crue  
Carne cruda



02 = BROWN / MARRONE  
Raw vegetables  
Verdure crude  
Rohes Gemüse  
Crudités  
Verduras crudas



04 = BLUE / BLU  
Raw fish  
Pesce  
Fisch  
Poisson  
Pescado



01 = YELLOW / GIALLO  
Cooked meats  
Carni cotte  
Gekochtes Fleisch  
Viande cuite  
Carne cocida



05 = GREEN / VERDE  
Salads and fruits  
Insalata e frutta  
Salat und Früchte  
Salade et fruits  
Ensalada y fruta



00 = WHITE / BIANCO  
Bakery and dairy products  
Pane e formaggi  
Brot und Käse  
Pain et fromages  
Pan y quesos



07 = VIOLA / VIOLET  
Gluten Free  
Casher  
Hallal  
Vegan



HDPE

**Cutting board**  
Tagliere bar  
Tranchierbrett  
Planche à découper  
Tabla de corte

| art.     | cm.       | GN  | col. |
|----------|-----------|-----|------|
| 42522-00 | 32x26,5x2 | 1/2 | ○    |
| 42522-01 | 32x26,5x2 | 1/2 | ●    |
| 42522-02 | 32x26,5x2 | 1/2 | ●    |
| 42522-03 | 32x26,5x2 | 1/2 | ●    |
| 42522-04 | 32x26,5x2 | 1/2 | ●    |
| 42522-05 | 32x26,5x2 | 1/2 | ●    |
| 42522-09 | 32x26,5x2 | 1/2 | ●    |



HDPE

**Cutting board**  
Tagliere bar  
Tranchierbrett  
Planche à découper  
Tabla de corte

| art.     | cm.       | GN  | col. |
|----------|-----------|-----|------|
| 42538-00 | 53x32,5x2 | 1/1 | ○    |
| 42538-01 | 53x32,5x2 | 1/1 | ●    |
| 42538-02 | 53x32,5x2 | 1/1 | ●    |
| 42538-03 | 53x32,5x2 | 1/1 | ●    |
| 42538-04 | 53x32,5x2 | 1/1 | ●    |
| 42538-05 | 53x32,5x2 | 1/1 | ●    |
| 42538-09 | 53x32,5x2 | 1/1 | ●    |

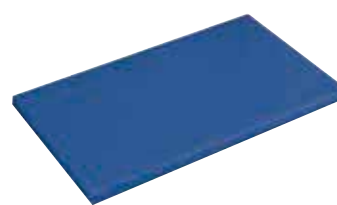

HDPE

**Cutting board**  
Tagliere bar  
Tranchierbrett  
Planche à découper  
Tabla de corte

| art.     | cm.     | col. |
|----------|---------|------|
| 42539-00 | 60x40x2 | ○    |
| 42539-01 | 60x40x2 | ●    |
| 42539-02 | 60x40x2 | ●    |
| 42539-03 | 60x40x2 | ●    |
| 42539-04 | 60x40x2 | ●    |
| 42539-05 | 60x40x2 | ●    |
| 42539-09 | 60x40x2 | ●    |



HDPE

**Cutting board**  
Tagliere bar  
Tranchierbrett  
Planche à découper  
Tabla de corte

| art.     | cm.       |
|----------|-----------|
| 42522-07 | 32x26,5x2 |
| 42538-07 | 53x32,5x2 |
| 42539-07 | 60x40x2   |



HDPE

**Cutting board**  
Tagliere bar  
Tranchierbrett  
Planche à découper  
Tabla de corte

| art.     | cm.     |
|----------|---------|
| 42537-40 | 40x30x2 |
| 42537-50 | 50x30x2 |
| 42537-80 | 80x40x2 |



HDPE

**Cutting board with groove**  
Tagliere con canalina  
Tranchierbrett mit Kanal  
Planche à découper avec rigole  
Tabla de corte con ranura

| art.     | cm.     | GN  | col. |
|----------|---------|-----|------|
| 42546-00 | 65x53x2 | 2/1 | ○    |
| 42546-01 | 65x53x2 | 2/1 | ●    |
| 42546-02 | 65x53x2 | 2/1 | ●    |
| 42546-03 | 65x53x2 | 2/1 | ●    |
| 42546-04 | 65x53x2 | 2/1 | ●    |
| 42546-05 | 65x53x2 | 2/1 | ●    |



HDPE

**Cutting board with stoppers**

Tagliere con fermi  
Tranchierbrett mit Stiften  
Planche à découper avec arrêts  
Tabla de corte con barras de la parada

| art.     | cm.       | GN  | col. |
|----------|-----------|-----|------|
| 42543-00 | 53x32,5x2 | 1/1 | ○    |
| 42543-01 | 53x32,5x2 | 1/1 | ●    |
| 42543-02 | 53x32,5x2 | 1/1 | ●    |
| 42543-03 | 53x32,5x2 | 1/1 | ●    |
| 42543-04 | 53x32,5x2 | 1/1 | ●    |
| 42543-05 | 53x32,5x2 | 1/1 | ●    |



HDPE

**Cutting board with stoppers**

Tagliere con fermi  
Tranchierbrett mit Stiften  
Planche à découper avec arrêts  
Tabla de corte con barras de la parada

| art.     | cm.     | col. |
|----------|---------|------|
| 42544-00 | 60x40x2 | ○    |
| 42544-01 | 60x40x2 | ●    |
| 42544-02 | 60x40x2 | ●    |
| 42544-03 | 60x40x2 | ●    |
| 42544-04 | 60x40x2 | ●    |
| 42544-05 | 60x40x2 | ●    |



HDPE

**Cutting board with stoppers**

Tagliere con fermi  
Tranchierbrett mit Stiften  
Planche à découper avec arrêts  
Tabla de corte con barras de la parada

| art.     | cm.     |
|----------|---------|
| 42540-40 | 40x30x2 |
| 42540-50 | 50x30x2 |
| 42540-80 | 80x40x2 |



HDPE

**Colored cutting boards set 6 pcs**

Taglieri colorati set 6 pz  
Tranchierbretter 6 Stk.  
Planches à découper set 6 pcs  
Juego 6 tablas de corte

| art.     | cm.       |
|----------|-----------|
| 42541-06 | 46x31x1,3 |



HDPE

**Round cutting board**

Tagliere tondo  
Tranchierbrett, rund  
Planche à découper, ronde  
Tabla de corte redonda

| art.     | Ø cm. | h. cm. |
|----------|-------|--------|
| 42535-24 | 24,0  | 1,0    |
| 42535-32 | 32,5  | 1,5    |
| 42535-49 | 49,0  | 1,5    |



HDPE

**Butchers table**

Ceppa  
Hackblock  
Billot  
Cepa

| art.     | cm.      | mm. |
|----------|----------|-----|
| 42518-50 | 50x50x86 | 4*  |

\*Thickness. – Spessore.





HDPE

**Worktop**

Ceppo  
Arbeitsplatte  
Plan de travail  
Encimera

art. cm. mm.  
42519-01 50x50 4\*

\*Thickness. – Spessore.



HDPE

**Board scraper**

Raschietto  
Raschier  
Blockschäber  
Racloir à planches  
Rascador

art. cm.  
42520-00 17x6x9

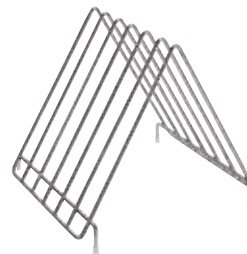

SS

**Cutting board rack**

Portataglieri in filo  
Tranchierbretter-Träger  
Sechoir à plaques à découper  
Porta tablas

art. cm.  
42542-00 30x26x27,5



W

**Bread cutting board**

Tagliere pane  
Brotschneidbrett  
Planche à découper  
Tabla de corte

art. cm.  
42964-53 53x32,5x2  
42964-60 60x40x2



CE

SS

**Chainmail glove**

Guanto in cotta di maglia  
Fingerhandschuhe  
Gant en cotte de mailles  
Guante de malla

art. size/T. col.  
48505-01 Small ○  
48505-02 Medium ●  
48505-03 Large ●

UNI EN 1082-1:1998. Fits either hands, rings ø 4 mm. Thickness ø 0,5 mm. nylon strap. Ambidestro, anelli ø 4 mm. Spessore ø 0,5 mm. cinturino nylon.



CE

SS

**Chainmail glove, extended cuff**

Guanto lungo in cotta di maglia  
Fingerhandschuhe, lang  
Gant en cotte de mailles, manchette longue  
Guante largo de malla

art. size/T. col.  
48506-01 Small ○  
48506-02 Medium ●  
48506-03 Large ●

UNI EN 1082-1:1998. Fits either hands, rings ø 4 mm. Thickness ø 0,5 mm. nylon strap. Ambidestro, anelli ø 4 mm. Spessore ø 0,5 mm. cinturino nylon.



CE

SS

**Protective apron**

Grembiule di protezione  
Schutzschürze  
Tablier de protection  
Delantal de protección

art. cm.  
48501-76 75x55

UNI EN 1082-1:1998. Belt fastening with textile adjustable and detachable straps. – Dotato di bretelle regolabili e staccabili.



**Oven mitt**

Guanto da forno  
Ofenhandschuh  
Moufle de déformement  
Manopla de protección

art. l. cm.  
48510-00 28

Outer fabric 100% cotton with silver coating, 100 g/mq. – Tessuto esterno 100% cotone con rivestimento argenteo 100 g/mq.



**Oven mitt, silicone**

Guanto da forno, silicone  
Backhandschuhe, Silikon  
Gant de protection, silicone  
Manopla de protección, silicona

art.  
48514-00

Ambidextrous. Contact heat resistant up to +300°C for 15 seconds. Non-slip, water and oil tight, dishwasher safe. – Ambidestro. Resistenza al calore per contatto fino a 300°C per 15 secondi. Stagno all'acqua e agli oli bollenti, lavabile in lavastoviglie.



**Cut resistant glove**

Guanto anti taglio  
Schnittschutz-Handschuh  
Gant anti-coupures  
Guante de protección

| art.     | size/T. |
|----------|---------|
| 48523-01 | S       |
| 48523-02 | M       |
| 48523-03 | L       |
| 48523-04 | XL      |

**Spectra fiber glove, cut resistance std EN388: level 5, washable up to 90°C, ambidextrous. Supplied with cotton underglove.** – Guanto in fibra spectra, resistenza al taglio std EN388: livello 5, lavabile fino a 90°C, ambidestro. Fornito con sottoguanto in cotone.



**Three-finger oven glove**

Guanti anticalore a 3 dita  
Backhandschuhe, 3 Finger  
Moufles protection thermique, 3 doigts  
Guantes de protección

| art.     | l. cm. |
|----------|--------|
| 48517-03 | 35,5   |

**Resistant to abrasion, tears and cuts. CE marking, in accordance to the basic requirements concerning health and security of the European Directives 89/686/C.E.E. Contact heat resistant up to +350°C for 20 seconds.**  
Resistenti all'abrasione, agli strappi ed ai tagli. Marcati CE, rispettano i requisiti essenziali di salute e sicurezza secondo le direttive europee 89/686/C.E.E. Hanno una resistenza al calore per contatto fino a 350°C per 20 secondi.



**Oven mitts**

Guanti da forno  
Backhandschuhe  
Moufles de défournement  
Manoplas de protección

| art.     | cm.   |
|----------|-------|
| 48511-02 | 34x16 |

**Special cotton fabric, natural color, reinforced palm and thumb. Heat resistant up to +200°C. Machine washable up to +40°C.**  
In cotone speciale, colore naturale, esecuzione rinforzata palmo e pollice. Resistente fino a +200°C. Lavabile in lavatrice max. 40°C.



**Oven mitts**

Guanti da forno  
Backhandschuhe  
Moufles de défournement  
Manoplas de protección

| art.     | cm.     |
|----------|---------|
| 48513-02 | 26x14,5 |

**Special cotton fabric, natural color, reinforced palm and thumb. Heat resistant up to +200°C. Machine washable up to +40°C.**  
In cotone speciale, colore naturale, esecuzione rinforzata palmo e pollice. Resistente fino a +200°C. Lavabile in lavatrice max. 40°C.



**Oven mitts**

Guanti da forno  
Backhandschuhe  
Moufles de défournement  
Manoplas de protección

| art.     | cm.   |
|----------|-------|
| 48512-02 | 27x15 |

**Special cotton fabric, natural color, reinforced palm and thumb. Heat resistant up to +200°C. Machine washable up to +40°C.**  
In cotone speciale, colore naturale, esecuzione rinforzata palmo e pollice. Resistente fino a +200°C. Lavabile in lavatrice max. 40°C.



**Oven glove, nitrile**

Guanti anticalore, nitrile  
Backhandschuhe, Nitril  
Moufles protection thermique, nitrile  
Guantes de protección, nitrile

| art.     | l. cm. | size/T. |
|----------|--------|---------|
| 48515-09 | 45     | 9       |
| 48515-11 | 45     | 11      |
| 48515-12 | 45     | 12      |

**Contact heat protection up to 150°C. Resistance to oils, grases and main detergents. Washable inside and outside.**  
Protezione al calore da contatto fino a 150°C. Resistenza agli oli, ai grassi e ai principali detersivi. Lavabili all'interno e all'esterno.



**Scrubbing gloves**

Guanti scrub  
Schrubben Handschuhe  
Gants à scrubbing  
Guantes para fregar

| art.     | size/T.  |
|----------|----------|
| 48518-01 | one size |



**Scrubbing gloves**

Guanti scrub  
Schrubben Handschuhe  
Gants à scrubbing  
Guantes para fregar

| art.     | size/T.  |
|----------|----------|
| 48518-02 | one size |



**Sugar gloves**

Guanti in lattice  
Zucker-Handschuhe  
Gants à tirer le sucre  
Guantes de látex

| art.     | size/T.   |
|----------|-----------|
| 48516-07 | 7 – 7 1/2 |
| 48516-08 | 8 – 8 1/2 |
| 48516-09 | 9 – 9 1/2 |



**Gloves, nitrile**

Guanti nitrile  
Handschuhe, Nitril  
Gants en nitrile  
Guantes de nitrilo

| art.     | pcs/pz | size/T. |
|----------|--------|---------|
| 48519-01 | 100    | S       |
| 48519-02 | 100    | M       |
| 48519-03 | 100    | L       |
| 48519-04 | 100    | XL      |

**Treatment Powder free. Latex-free. Finish microgrip.** – Trattamento Powder free. Latex free. Finitura Microgrip.



HDPE

**Gloves**

Guanti  
Handschuhe  
Gants  
Guantes

| art.     | l. cm. | pcs/pz | size/T.  |
|----------|--------|--------|----------|
| 48522-24 | 24     | 500    | one size |

**Palm and fingers microgrip finishing.**  
Finitura palmo e dita microgrip.



**Paper Chef hat**

Cappello Grand Chef, carta  
Kochmütze, Papier  
Toque papier  
Tocado, papel

| art.     | h. cm. | pcs/pz |
|----------|--------|--------|
| 48520-20 | 20     | 20     |
| 48520-23 | 23     | 20     |
| 48520-30 | 30     | 20     |

**Double crepe paper processing, absorbent, adjustable size, ventilated.** – Carta crespata doppia lavorazione, fascia assorbi sudore, adesivo regolabile, areato.



**Apron, LDPE**

Grembiule LDPE  
Schurz, LDPE  
Tablier, LDPE  
Delantal, LDPE

| art.     | cm.    | pcs/pz |
|----------|--------|--------|
| 48524-75 | 75x120 | 50     |

**Waterproof and resistant, length 120 cm from the chest, total length 140 cm.**  
Impermeabile e resistente, lunghezza 120 cm dal petto, totale 140 cm.



**Chef's hat, TNT**

Cappello Monsieur Chef, TNT  
Chef-Kochmütze, tnt  
Toque plissée chef, TNT  
Gorro Chef, TNT

| art.     | pcs/pz |
|----------|--------|
| 48529-00 | 20     |

**Tnt-polypropylene, pleated, band absorb sweat, adjustable adhesive to fix the size.**  
Tnt-polipropilene, plissettato, fascia assorbi sudore, adesivo regolabile per fissare la taglia.



**Paper cap**

Bustina carta  
Papier Mütze  
Calot papier  
Gorro barco papel

| art.     | pcs/pz |
|----------|--------|
| 48528-00 | 100    |

**Double paper processing, absorbent, adjustable size, ventilated.** – Carta doppia lavorazione, fascia assorbi sudore, adesivo regolabile, aerata.



**Cap, TNT**

Cuffia, TNT  
Einweghauben, TNT  
Charlotte, TNT  
Cubrecabezas, TNT

| art.     | pcs/pz |
|----------|--------|
| 48527-00 | 100    |

**Pleated cap, TNT 16gr/m2, very light, soft elastic, ø 50 cm.** – Cuffia plissettata TNT 16gr/m2, molto leggera, morbido elastico, ø 50 cm.



**Visitor kit, TNT**

Kit visitatore, TNT  
Besucher-Kits, TNT  
Kit visiteur, TNT  
Conjunto visitador, TNT

| art.     | pcs/pz |
|----------|--------|
| 48525-03 |        |

**1 TNT overall and cap, 1 CPE overshoes.**  
1 camice e cuffia in TNT e 1 set copriscarpe CPE.



PE

**Overshoes**

Copriscarpe  
Überschuhe  
Sur-chaussures  
Cubrezapatos

| art.     | l. cm. | pcs/pz |
|----------|--------|--------|
| 48526-44 | 44     | 110    |

**PE double-thickness, waterproof, elastic ankle, embossed bottom.** – PE doppio spessore, impermeabili, elastico alla caviglia, fondo gofrato.

# PASTRY PASTICCERIA

EQUIPMENT  
ATTREZZATURE





**Alphabet pcs 26**

Alfabeto pz 26

| art.     | Ø cm. | h. cm. |
|----------|-------|--------|
| 47301-12 | 12    | 2      |



**Numbers pcs 10**

Numeri pz 10

| art.     | Ø cm. | h. cm. |
|----------|-------|--------|
| 47302-10 | 10    | 2      |



**Animals pcs 10**

Animali pz 10

| art.     | Ø cm. | h. cm. |
|----------|-------|--------|
| 47303-10 | 10    | 2      |

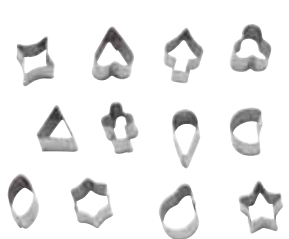

**Shapes pcs 12**

Sagome pz 12

| art.     | Ø cm. | h. cm. |
|----------|-------|--------|
| 47304-06 | 6,5   | 2      |

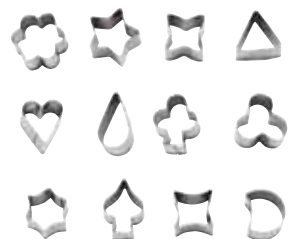

**Shapes pcs 12**

Sagome pz 12

| art.     | Ø cm. | h. cm. |
|----------|-------|--------|
| 47304-10 | 10    | 2      |



**Shapes pcs 12**

Sagome pz 12

| art.     | Ø cm. | h. cm. |
|----------|-------|--------|
| 47304-12 | 12    | 2      |



**Shapes pcs 12**

Sagome pz 12

| art.     | Ø cm. | h. cm. |
|----------|-------|--------|
| 47305-12 | 12    | 2      |



**Flower pcs 6**

Fiore pz 6

| art.     | Ø cm. | h. cm. |
|----------|-------|--------|
| 47306-10 | 10    | 3      |



**Trio pcs 6**

Trio pz 6

| art.     | Ø cm. | h. cm. |
|----------|-------|--------|
| 47307-10 | 10    | 3      |



**Heart pcs 6**

Cuore pz 6

| art.     | Ø cm. | h. cm. |
|----------|-------|--------|
| 47308-10 | 10    | 3      |



**Star pcs 6**

Stella pz 6

| art.     | Ø cm. | h. cm. |
|----------|-------|--------|
| 47310-10 | 10    | 3      |



**Halfmoon pcs 6**

Mezzaluna pz 6

| art.     | Ø cm. | h. cm. |
|----------|-------|--------|
| 47312-10 | 10    | 3      |



**Hexagon pcs 6**

Esagono pz 6

| art.     | Ø cm. | h. cm. |
|----------|-------|--------|
| 47314-10 | 10    | 3      |



**Hexagon, fluted pcs 5**

Esagono festonato pz 5

| art.     | Ø cm. | h. cm. |
|----------|-------|--------|
| 47315-10 | 10    | 3,5    |



**Ring pcs 11**

Anello pz 11

| art.     | Ø cm. | h. cm. |
|----------|-------|--------|
| 47316-10 | 10    | 3      |



**Ring pcs 14**

Anello pz 14

| art.     | Ø cm. | h. cm. |
|----------|-------|--------|
| 47316-12 | 12    | 3      |



**Ring pcs 20**

Anello pz 20

| art.     | Ø cm. | h. cm. |
|----------|-------|--------|
| 47316-20 | 20    | 2,5    |



**Ring, fluted pcs 11**

Anello festonato pz 11

| art.     | Ø cm. | h. cm. |
|----------|-------|--------|
| 47317-10 | 10    | 3      |





**Ring, fluted pcs 14**

Anello festonato pz 14

art.      Ø cm.    h. cm.  
47317-12    12      3



**Ring, fluted pcs 20**

Anello festonato pz 20

art.      Ø cm.    h. cm.  
47317-20    20      2,5



**Drop pcs 6**

Goccia pz 6

art.      Ø cm.    h. cm.  
47321-12    12      3



**Drop, fluted pcs 5**

Goccia festonata pz 5

art.      Ø cm.    h. cm.  
47322-12    12,5    3,5



**Square pcs 6**

Quadro pz 6

art.      Ø cm.    h. cm.  
47323-12    12      3



**Square, fluted pcs 6**

Quadro festonato pz 6

art.      Ø cm.    h. cm.  
47324-12    12,5    3,5



**Oval pcs 9**

Ovale pz 9

art.      Ø cm.    h. cm.  
47326-10    10      3,5



**Oval, fluted pcs 9**

Ovale festonato pz 9

art.      Ø cm.    h. cm.  
47325-10    10      3,5



**Fruit pcs 12**

Frutta pz 12

art.      Ø cm.    h. cm.  
47327-12    12,5    2



**Animals pcs 10**

Animali pz 10

art.      Ø cm.    h. cm.  
47328-15    15      2



**Vehicles pcs 7**

Veicoli pz 7

art.      Ø cm.    h. cm.  
47331-15    15      2



**Vegetable pcs 12**

Verdura pz 12

art.      Ø cm.    h. cm.  
47332-12    12,5    2



**Christmas pcs 7**

Natale pz 7

art.      Ø cm.    h. cm.  
47333-15    15      2



**Easter pcs 6**

Pasqua pz 6

art.      Ø cm.    h. cm.  
47334-12    12,5    2

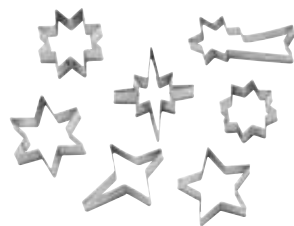

**Stars pcs 7**

Stelle pz 7

art.      Ø cm.    h. cm.  
47335-12    12,5    2



**Shapes pcs 10**

Sagome pz 10

art.      Ø cm.    h. cm.  
47419-10    20      3,5



**Shapes pcs 42**

Sagome pz 42

art.      Ø cm.  
47336-42    6>22



**Plain ring pcs 3**

Anello liscio pz 3

art.      Ø cm.    h. cm.  
47414-03    6-7-8    3



**Fluted ring pcs 3**

Anello festonato pz 3

art.      Ø cm.    h. cm.  
47415-03    6-7-8    3



**Canestrello**

Canestrello

art.      Ø cm.    h. cm.  
47416-06    6      3



**Canestrello, fluted**  
Canestrello festonato

art. Ø cm. h. cm.  
47417-06 6 3



**Wheel**  
Ruota

art.  
47418-00



**CHRISTMAS**  
NATALE



**Gingerbread man**  
Omino pan di zenzero

art. cm.  
47370-08 6x8x3



**Angel**  
Angelo

art. cm.  
47377-08 7x7x3



**Snowman**  
Pupazzo di neve

art. cm.  
47378-08 4x8x3



**Reindeer**  
Renna

art. cm.  
47379-08 8x7x3



**Star**  
Stella

art. cm.  
47411-08 8x8x3

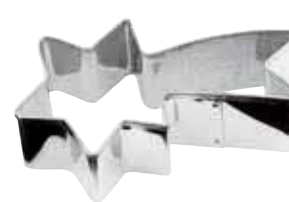

**Comet**  
Stella cometa

art. cm.  
47412-08 8x4x3



**Christmas tree**

Albero di Natale

art. cm.  
47413-08 8x8x3



**Pine**

Pino

art. cm.  
47413-01 6,4x8x3



**Snowflake**

Fiocco di neve

art. cm.  
47411-01 7,4x8,6x3



**Snowflake**

Fiocco di neve

art. cm.  
47411-02 7x8x3



**Snowflake**

Fiocco di neve

art. cm.  
47411-03 8,5x8x3



**Christmas, set of 6 pcs.**

Natale set 6 pz

art. cm.  
47387-01 8x8x3



**EASTER  
PASQUA**



**Rabbit  
Coniglio**

art. cm.  
47372-08 8x4x3

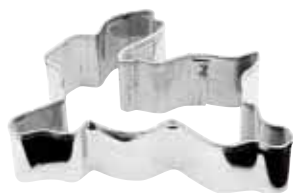

**Rabbit  
Coniglio**

art. cm.  
47402-08 8x5x3



**Rabbit  
Coniglio**

art. cm.  
47402-01 7x8,5x3







**Rabbit**

Coniglio

art. cm.  
47402-02 7,5x7x3



**Bell**

Campana

art. cm.  
47373-08 6x7x3



**Lamb**

Agnellino

art. cm.  
47376-08 8x7x3



**Dove**

Colomba

art. cm.  
47382-08 8x7x3



**Egg**

Uovo

art. cm.  
47373-01 5,6x8x3

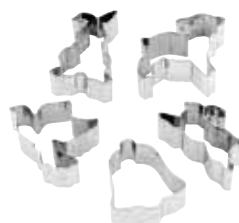

**Easter, set of 5 pcs.**

Pasqua set 5 pz

art. cm.  
47387-02 8x8x3



**HALLOWEEN**



**Skeleton**  
Scheletro

art. cm.  
47370-08 6x8x3



**Pumpkin**  
Zucca

art. cm.  
47377-09 9x8x3



**Pumpkin**  
Zucca

art. cm.  
47377-10 8x8x3



**Crescent**

Mezzaluna

art. cm.  
47377-01 6,2x8x3



**Owl**

Gufo

art. cm.  
47377-02 4,7x8,3x3



**Ghost**

Fantasma

art. cm.  
47377-03 8x8,4x3

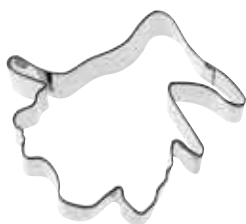

**Witch**

Strega

art. cm.  
47377-04 9x9,5x3

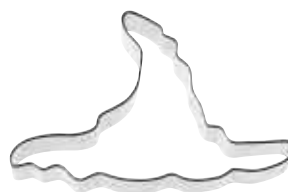

**Witch hat**

Cappello strega

art. cm.  
47377-05 8,5x13x3

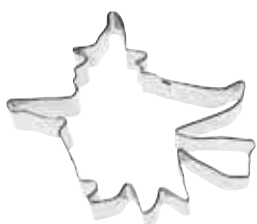

**Witch on broom**

Strega su scopa

art. cm.  
47377-06 11,6x12x3



**Skull**

Teschio

art. cm.  
47377-07 8x8x3

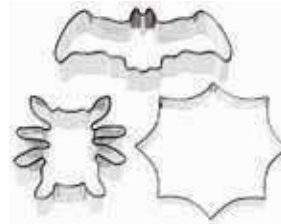

**Halloween, set of 3 pcs.**

Halloween set 3 pz

art. cm.  
47377-11 11x10,7x2



**ANIMALS & VARIOUS**  
ANIMALI & VARI





**Honey bee**

Ape

art. cm.  
47382-06 11,6x8x3



**Hippo**

Ippopotamo

art. cm.  
47404-04 11x7x3

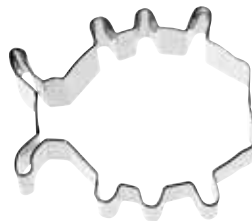

**Ladybug**

Coccinella

art. cm.  
47404-05 8x8x3



**Butterfly**

Farfalla

art. cm.  
47371-08 8x7x3



**Snail**

Lumaca

art. cm.  
47404-02 11x6x3



**Fish**

Pesce

art. cm.  
47384-08 8x8x3



**Frog**

Rana

art. cm.  
47380-08 8x8x3



**Rooster**

Gallo

art. cm.  
47383-08 8x8x3



**Dolphin**

Delfino

art. cm.  
47384-01 5x9x3



**Seagull**

Gabbiano

art. cm.  
47386-08 11x6x3



**Cat**

Gatto

art. cm.  
47401-08 8x8x3



**Goose**

Oca

art. cm.  
47404-08 8x7x3



**Teddy bear**

Orsetto

art. cm.  
47375-08 8x8x3



**Teddy bear**  
Orsetto

art. cm.  
47375-01 6x9x3

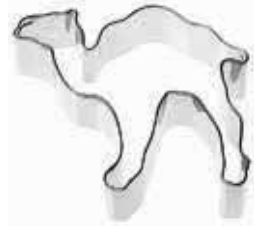

**Camel**  
Cammello

art. cm.  
47404-01 9x8,6x3

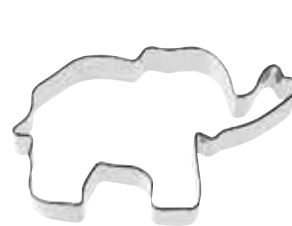

**Elephant**  
Elefante

art. cm.  
47404-03 12x7x3





**Four leaf clover**

Quadrifoglio

art. cm.

47374-08 8x8X3

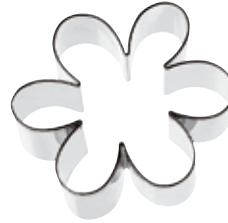

**Flower**

Fiore

art. cm.

47374-02 7x7,4x3



**Tulip**

Tulipano

art. cm.

47374-01 5,5x8x3



**Heart**

Cuore

art. cm.

47385-08 8x9x3



**Two hearts**

Due cuori

art. cm.

47385-01 9,4x5x3



**Rocking horse**

Cavallo a dondolo

art. cm.

47381-08 8x5x3



**Bow**

Fiocco

art. cm.

47373-02 6x8x3



**Apple**

Mela

art. cm.

47378-01 7,6x8,4x3



**Pirate ship**

Nave pirata

art. cm.

47370-03 8x8,4x3



**Airplane**

Aereo

art. cm.

47370-02 9x8x3



**Train**

Locomotiva

art. cm.

47370-01 10x7x3

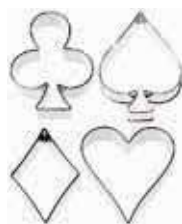

**Suits of cards, set of 4 pcs**

Semi carte set 4 pz

art. cm.

47378-02 7,5x7,5x3





**Numbers, set of 9 pcs**

Numeri, set 9 pz

art. cm.  
47421-09 6,5x2,5



**Letters, set of 26 pcs**

Lettere, set 26 pz

art. cm.  
47422-26 6x2,5



**Round, set 6 pcs**

Cerchio, set 6 pz

art. cm.  
47425-01 4x3  
47425-02 5x3  
47425-03 6x3

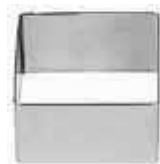

**Square, set 6 pcs**

Quadro, set 6 pz

art. cm.  
47425-04 5x5x3  
47425-05 6x6x3



**Triangle, set 6 pcs**

Triangolo, set 6 pz

art. cm.  
47425-06 6x3



**Oval, set 6 pcs**

Ovale, set 6 pz

art. cm.  
47425-09 7,5x4,5x3



**Trapeze, set 6 pcs**

Trapezio, set 6 pz

art. cm.  
47425-08 9x6x3



**Rectangle, set 6 pcs**

Rettangolo, set 6 pz

art. cm.  
47425-10 5x3,5x3  
47425-11 6x5x3



**Drop, set 6 pcs**

Goccia, set 6 pz

art. cm.  
47425-26 9x3



**Hexagon, set 6 pcs**

Esagono, set 6 pz

art. cm.  
47425-29 5x3  
47425-30 6x3



**Heart, set 6 pcs**

Cuore, set 6 pz

art. cm.  
47425-32 6,5x3



**Square, set 6 pcs**

Quadro, set 6 pz

art. cm.  
47426-01 8x8x4,5



**Rectangle**

Rettangolo

art. cm.  
47426-07 12x6x4,5



**Doughnut cutter**

Tagliapasta per doughnuts

Donut-Ausstecher

Coupe-donuts

Cortadonuts

art. Ø cm. h. cm.  
47388-06 65-25 20  
47388-07 70-30 17  
47388-08 80-40 20



**Cinnamon star cutter**

Tagliapaste stelle

Zimstern-Ausstecher

Coupe-étoiles

Cortapasta Esterella

art. cm.  
47377-15 5x9,7

Spring mechanism. – Meccanismo a molla.



**Horseshoe, tin plate**

Ferro di cavallo, banda stagnata

Hufeisen, Weißblech

Fer à cheval, fer blanc

Herradura, hojalata

art. cm.  
47377-12 7x6x2

CUTTERS  
TAGLIAPASTA



**Round**

Rotondo

| art.     | Ø cm. | h. cm. |
|----------|-------|--------|
| 12943-03 | 3     | 3,5    |
| 12943-05 | 5     | 3,5    |
| 12943-07 | 7     | 3,5    |
| 12943-08 | 8     | 3,5    |
| 12943-10 | 10    | 3,5    |
| 12943-12 | 12    | 3,5    |



**Round, fluted**

Rotondo festonato

| art.     | Ø cm. | h. cm. |
|----------|-------|--------|
| 12944-03 | 3     | 3,5    |
| 12944-05 | 5     | 3,5    |
| 12944-07 | 7     | 3,5    |
| 12944-08 | 8     | 3,5    |
| 12944-10 | 10    | 3,5    |
| 12944-12 | 12    | 3,5    |



**Oval, fluted**

Ovale festonato

| art.     | cm.       |
|----------|-----------|
| 12947-02 | 5,5x3,5x4 |
| 12947-03 | 7x4x4     |
| 12947-04 | 8,5x5x4   |
| 12947-05 | 10x6x4    |
| 12947-06 | 11x7x4    |
| 12947-07 | 13x5x4    |



**Set 6 pcs round pastry cutters**

Scatola tagliapasta rotondi, 6 pz

art.  
12943-13



**Set 6 pcs fluted round pastry cutters**

Scatola tagliapasta rotondi festonati, 6 pz

art.  
12944-13



**Set 6 pcs fluted oval pastry cutters**

Scatola tagliapasta ovali festonati, 6 pz

art.  
12947-13



**Dough plunger cutters w/extractor, 3 pcs**

Tagliapasta con espulsore, set 3 pz  
Ausstechformen mit Auswerfer, 3 Stk  
Emportes-pièces, 3 pcs  
Cortadores, 3 pz

| art.     | Ø cm. |
|----------|-------|
| 47622-04 | 3,4,5 |

Holly. – Agrifoglio.



**Dough plunger cutters w/extractor, 4 pcs**

Tagliapasta con espulsore, set 4 pz  
Ausstechformen mit Auswerfer, 4 Stk  
Emportes-pièces, 4 pcs  
Cortadores, 4 pz

| art.     | Ø cm.               |
|----------|---------------------|
| 47622-26 | 1,2 - 2 - 2,8 - 3,5 |

Daisy. – Margherita.



**Dough plunger cutters w/extractor, 3 pcs**

Tagliapasta con espulsore, set 3 pz  
Ausstechformen mit Auswerfer, 3 Stk  
Emportes-pièces, 3 pcs  
Cortadores, 3 pz

art. Ø cm.

47622-01 3:5

**Petunie. – Petunia.**



**Dough plunger cutters w/extractor, 3 pcs**

Tagliapasta con espulsore, set 3 pz  
Ausstechformen mit Auswerfer, 3 Stk  
Emportes-pièces, 3 pcs  
Cortadores, 3 pz

art. Ø cm.

47622-02 2,5

**Flower. – Fiore.**



**Dough plunger cutters w/extractor, 3 pcs**

Tagliapasta con espulsore, set 3 pz  
Ausstechformen mit Auswerfer, 3 Stk  
Emportes-pièces, 3 pcs  
Cortadores, 3 pz

art. Ø cm.

47622-03 3:5

**Rose leaf. – Foglia di rosa.**



**SS**

**Set of 9 cutters**

Set 9 tagliapasta  
Satz 9 Ausstechformen  
Set 9 découpoirs  
Juego 9 cortadores

art. h. cm.

47837-09 0,5



**PA**

**Almont past knife**

Coltello per marzapane  
Marzipan-Messer  
Couteau à pâte d'amande  
Cuchillo para fondant/mazapán

art. l. cm.

47630-28 16,5



**PP**

**Marzipan set, 15 pcs**

Set 15 pezzi per marzapane  
Marzipan-Satz, 15 Stk.  
Set 15 outils à pâte d'amandes  
Set de 15 herramientas para decorar galletas

art.

47631-12



**PP**

**Marzipan set, 8 pcs**

Set 8 pezzi per marzapane  
Marzipan-Satz, 8 Stk.  
Set 8 outils à pâte d'amandes  
Set de 8 herramientas para decorar galletas

art.

47631-08



**SS**

**Set of 10 pcs dipping forks**

Set 10 forchettine pralineria  
Pralinen Gabelchen, 10 Stk.  
Jeu de 10 ébauchoirs  
Set de 10 herramientas para decorar chocolates

art.

47833-10



**SS**

**Set of 4 pcs dipping forks**

Set 4 forchettine pralineria  
Pralinen Gabelchen, 4 Stk.  
Jeu de 4 ébauchoirs  
Set de 4 herramientas para decorar chocolates

art.

47833-04



**SS**

**Set 2 decorating spoons**

Set 2 cucchiai decorazione  
Satz 2 Dekoration-Löffel  
Set 2 cuillères pour décorer  
2 cucharas para decoración

art. l. cm.

47831-02 19-23



**STAINLESS STEEL NOZZLES**  
**BOCCHETTE INOX**

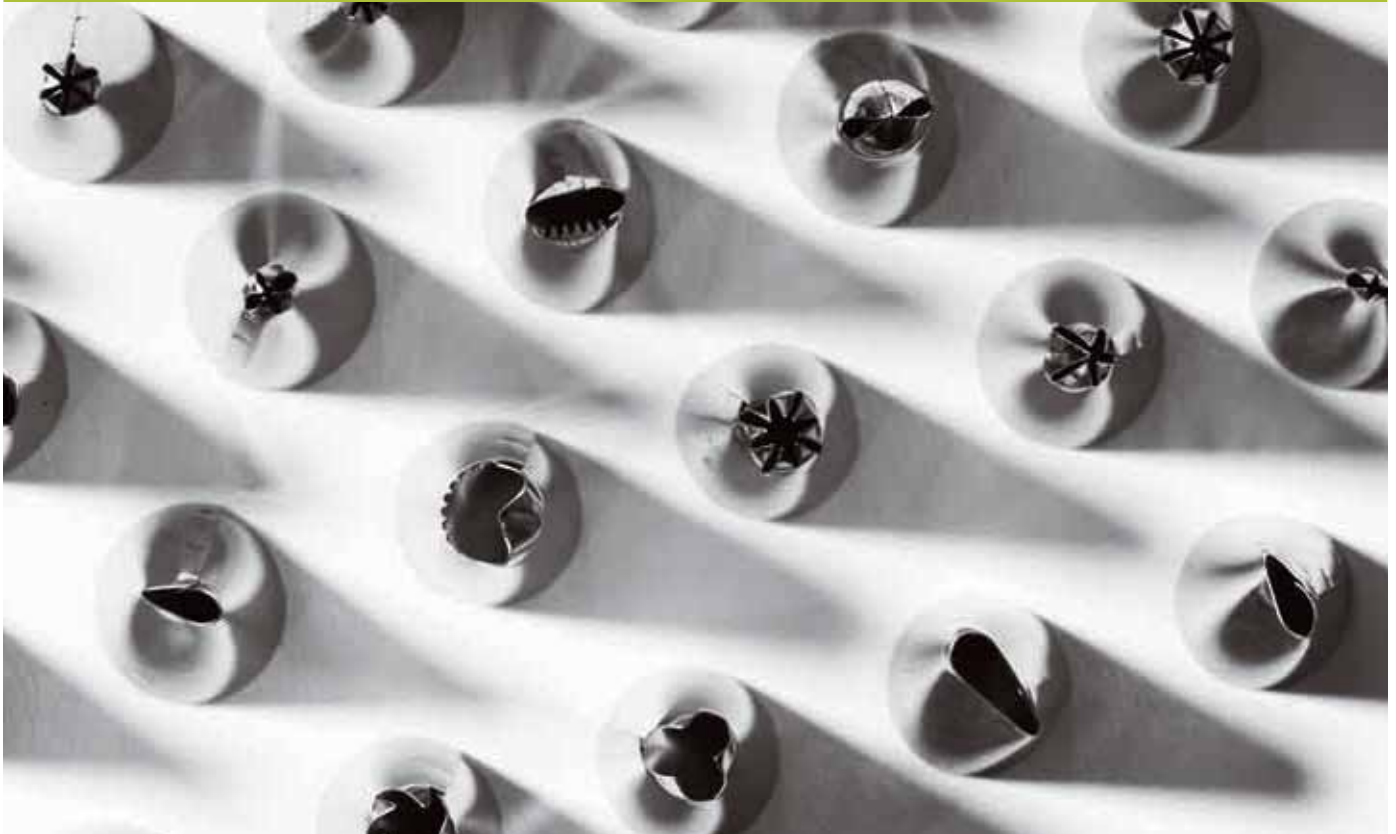

**Set 12 pcs, one piece nozzles**

Set 12 bocchette unipezzo  
Tüllen Set 12 Stk. aus einem Stück gezogen  
Set 12 pcs douilles monobloc  
Surtido 12 boquillas monobloc

| art.     | Ø mm.   | base ø mm. |
|----------|---|------------|
| 47357-20 | 1x 0,6-1,2-1,5-1,9-2,4-3<br>3,6-4,8-5,6-6,4-6,8-7,6 | 18         |

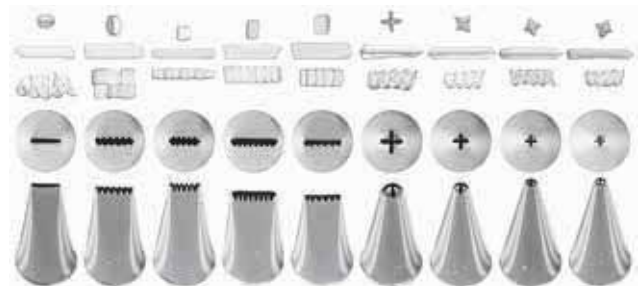

**Set 9 pcs, one piece nozzles**

Set 9 bocchette unipezzo  
Tüllen Set 9 Stk. aus einem Stück gezogen  
Set 9 pcs douilles monobloc  
Surtido 9 boquillas monobloc

| art.     | base ø mm. |
|----------|------------|
| 47357-24 | 18         |



**Set 7 pcs, one piece nozzles**

Set 7 bocchette unipezzo  
Tüllen Set 7 Stk. aus einem Stück gezogen  
Set 7 pcs douilles monobloc  
Surtido 7 boquillas monobloc

| art.     | Ø mm.                      | base ø mm. |
|----------|----------------------------|------------|
| 47357-21 | 1x 1,7-2,2-3,5-4,2-5-5,5-7 | 18         |



**Set 8 pcs, one piece nozzles**

Set 8 bocchette unipezzo  
Tüllen Set 8 Stk. aus einem Stück gezogen  
Set 8 pcs douilles monobloc  
Surtido 8 boquillas monobloc

| art.     | Ø mm.                        | base ø mm. |
|----------|------------------------------|------------|
| 47357-22 | 1x 1-1,5-1,8-2,6-3-3,4-2,5-7 | 18         |



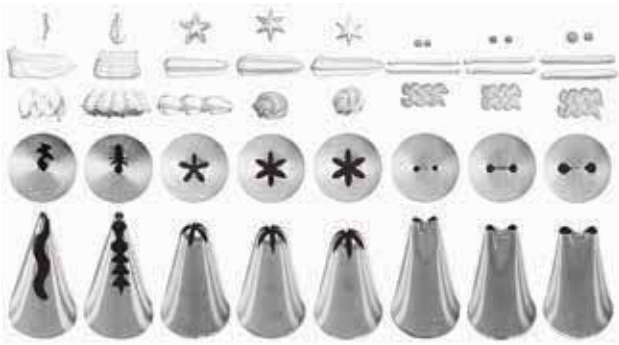

**Set 8 pcs, one piece nozzles**

Set 8 bocchette unipezzo

Tüllen Set 8 Stk. aus einem Stück gezogen

Set 8 pcs douilles monobloc

Surtido 8 boquillas monobloc

art. base ø mm.

47357-23 18

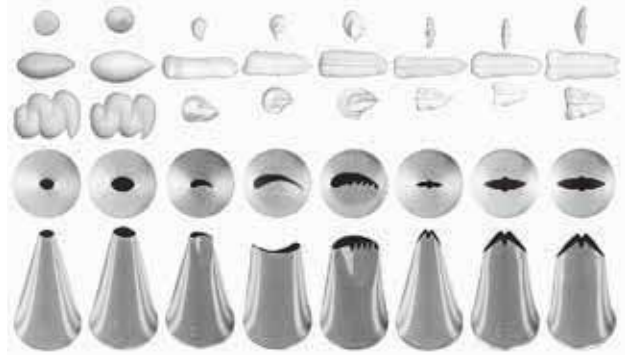

**Set 8 pcs, one piece nozzles**

Set 8 bocchette unipezzo

Tüllen Set 8 Stk. aus einem Stück gezogen

Set 8 pcs douilles monobloc

Surtido 8 boquillas monobloc

art. base ø mm.

47357-25 18



**Set 8 pcs, one piece nozzles**

Set 8 bocchette unipezzo

Tüllen Set 8 Stk. aus einem Stück gezogen

Set 8 pcs douilles monobloc

Surtido 8 boquillas monobloc

art. base ø mm.

47357-26 18

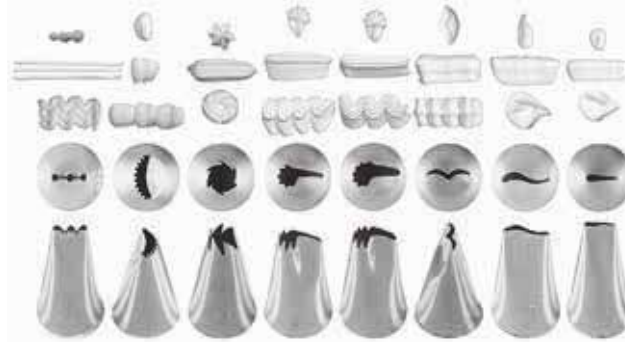

**Set 8 pcs, one piece nozzles**

Set 8 bocchette unipezzo

Tüllen Set 8 Stk. aus einem Stück gezogen

Set 8 pcs douilles monobloc

Surtido 8 boquillas monobloc

art. base ø mm.

47357-27 18



**Set 8 pcs, one piece nozzles**

Set 8 bocchette unipezzo

Tüllen Set 8 Stk. aus einem Stück gezogen

Set 8 pcs douilles monobloc

Surtido 8 boquillas monobloc

art. base ø mm.

47357-28 18

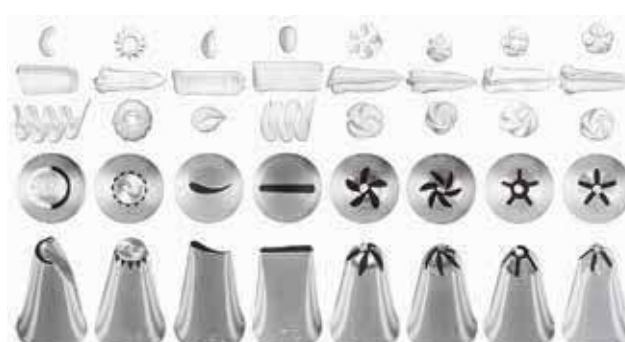

**Set 8 pcs, one piece nozzles**

Set 8 bocchette unipezzo

Tüllen Set 8 Stk. aus einem Stück gezogen

Set 8 pcs douilles monobloc

Surtido 8 boquillas monobloc

art. base ø mm.

47357-29 18





**Set 8 pcs, one piece nozzles**

Set 8 bocchette unipezzo  
Tüllen Set 8 Stk. aus einem Stück gezogen  
Set 8 pcs douilles monobloc  
Surtido 8 boquillas monobloc

art. base ø mm.  
47357-30 18

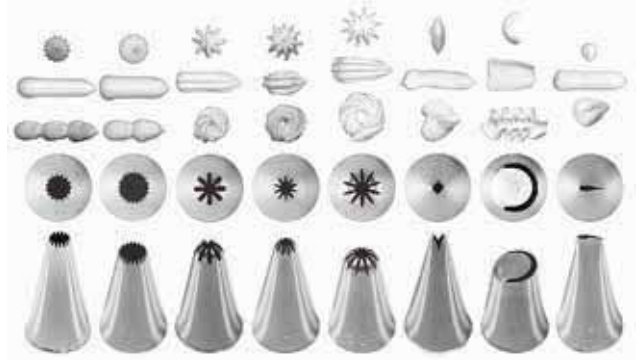

**Set 8 pcs, one piece nozzles**

Set 8 bocchette unipezzo  
Tüllen Set 8 Stk. aus einem Stück gezogen  
Set 8 pcs douilles monobloc  
Surtido 8 boquillas monobloc

art. base ø mm.  
47357-31 18



**Set 6 pcs, one piece nozzles**

Set 6 bocchette unipezzo  
Tüllen Set 6 Stk. aus einem Stück gezogen  
Set 6 pcs douilles monobloc  
Surtido 6 boquillas monobloc

art. base ø mm.  
47357-06 25



**Set 6 pcs, one piece nozzles**

Set 6 bocchette unipezzo  
Tüllen Set 6 Stk. aus einem Stück gezogen  
Set 6 pcs douilles monobloc  
Surtido 6 boquillas monobloc

art. base ø mm.  
47357-07 25



**Set 6 pcs, one piece nozzles**

Set 6 bocchette unipezzo  
Tüllen Set 6 Stk. aus einem Stück gezogen  
Set 6 pcs douilles monobloc  
Surtido 6 boquillas monobloc

art. base ø mm.  
47357-08 25

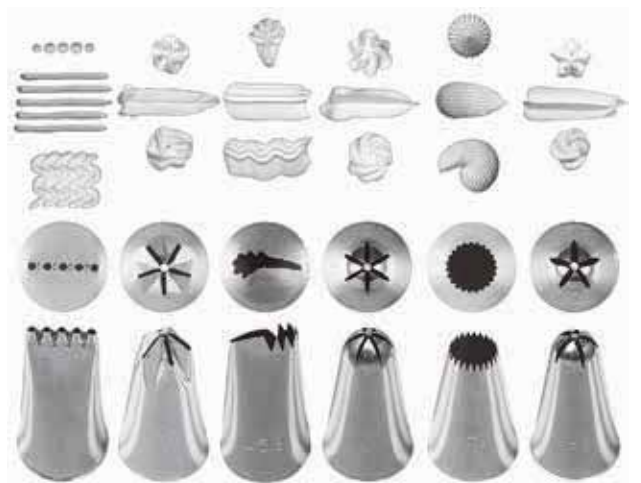

**Set 6 pcs, one piece nozzles**

Set 6 bocchette unipezzo  
Tüllen Set 6 Stk. aus einem Stück gezogen  
Set 6 pcs douilles monobloc  
Surtido 6 boquillas monobloc

art. base ø mm.  
47357-09 25

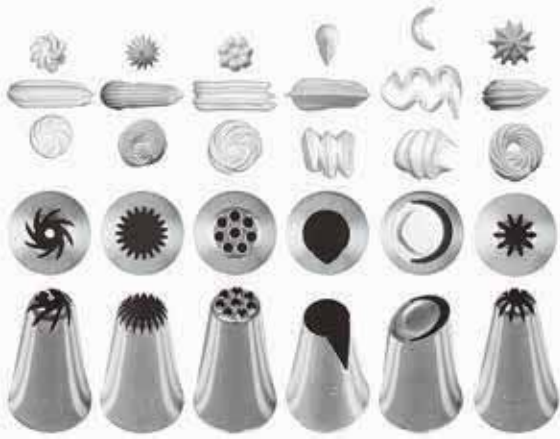

**Set 6 pcs, one piece nozzles**

Set 6 bocchette unipezzo

Tüllen Set 6 Stk. aus einem Stück gezogen

Set 6 pcs douilles monobloc

Surtido 6 boquillas monobloc

art. base ø mm.

47357-10 25



**Set 6 pcs, one piece nozzles**

Set 6 bocchette unipezzo

Tüllen Set 6 Stk. aus einem Stück gezogen

Set 6 pcs douilles monobloc

Surtido 6 boquillas monobloc

art. base ø mm.

47357-11 25



**Set 4 pcs, one piece nozzles**

Set 4 bocchette unipezzo

Tüllen Set 4 Stk. aus einem Stück gezogen

Set 4 pcs douilles monobloc

Surtido 4 boquillas monobloc

art. base ø mm.

47357-01 31



**Set 4 pcs, one piece nozzles**

Set 4 bocchette unipezzo

Tüllen Set 4 Stk. aus einem Stück gezogen

Set 4 pcs douilles monobloc

Surtido 4 boquillas monobloc

art. base ø mm.

47357-02 2x 31 - 2x 36



**Set 7 pcs, one piece nozzles**

Set 7 bocchette unipezzo

Tüllen Set 7 Stk. aus einem Stück gezogen

Set 7 pcs douilles monobloc

Surtido 7 boquillas monobloc

art. base ø mm.

47357-03 31





**Set 3x2 nozzles**

Set 3x2 bocchette

3x2 Stk. Tüllen

Set 3x2 pcs douilles

Juego 3x2 boquillas

| art.     | Ø mm. | stars |
|----------|-------|-------|
| 47350-01 | 2x 25 | 6     |
|          | 2x 31 | 6     |
|          | 2x 36 | 6     |



**Set 3x2 nozzles**

Set 3x2 bocchette

3x2 Stk. Tüllen

Set 3x2 pcs douilles

Juego 3x2 boquillas

| art.     | Ø mm. | stars |
|----------|-------|-------|
| 47351-01 | 2x 31 | 6     |
|          | 2x 31 | 8     |
|          | 2x 36 | 9     |



**Set 3x2 nozzles**

Set 3x2 bocchette

3x2 Stk. Tüllen

Set 3x2 pcs douilles

Juego 3x2 boquillas

| art.     | Ø mm. | stars |
|----------|-------|-------|
| 47352-01 | 2x 31 | 6     |
|          | 2x 31 | 8     |
|          | 2x 36 | 9     |



**Set 6 pcs, one piece nozzles**

Set 6 bocchette unipezzo

Tüllen Set 6 Stk. aus einem Stück gezogen

Set 6 pcs douilles monobloc

Surtido 6 boquillas monobloc

| art.     | Ø mm. | stars |
|----------|-------|-------|
| 47208-01 | 3,0   | 5     |
| 47208-02 | 3,0   | 6     |
| 47208-03 | 3,5   | 7     |
| 47208-04 | 5,0   | 8     |



**Set 6 pcs, one piece nozzles**

Set 6 bocchette unipezzo

Tüllen Set 6 Stk. aus einem Stück gezogen

Set 6 pcs douilles monobloc

Surtido 6 boquillas monobloc

| art.     | Ø mm. | stars |
|----------|-------|-------|
| 47208-05 | 5     | 5     |
| 47208-06 | 5     | 6     |
| 47208-07 | 6     | 7     |
| 47208-08 | 7     | 8     |



**Set 6 pcs, one piece nozzles**

Set 6 bocchette unipezzo

Tüllen Set 6 Stk. aus einem Stück gezogen

Set 6 pcs douilles monobloc

Surtido 6 boquillas monobloc

| art.     | Ø mm. | stars |
|----------|-------|-------|
| 47208-09 | 7     | 5     |
| 47208-10 | 7     | 6     |
| 47208-11 | 7     | 7     |
| 47208-12 | 9     | 8     |



**Set 6 pcs, one piece nozzles**

Set 6 bocchette unipezzo

Tüllen Set 6 Stk. aus einem Stück gezogen

Set 6 pcs douilles monobloc

Surtido 6 boquillas monobloc

| art.     | Ø mm. | stars |
|----------|-------|-------|
| 47208-13 | 11    | 5     |
| 47208-14 | 11    | 6     |
| 47208-15 | 11    | 7     |
| 47208-16 | 11    | 8     |



**Set 6 pcs, one piece nozzles**

Set 6 bocchette unipezzo  
Tüllen Set 6 Stk. aus einem Stück gezogen  
Set 6 pcs douilles monobloc  
Surtido 6 boquillas monobloc

| art.     | Ø mm. | stars |
|----------|-------|-------|
| 47208-17 | 13    | 5     |
| 47208-18 | 13    | 6     |
| 47208-19 | 13    | 7     |
| 47208-20 | 13    | 8     |

**Set 6 pcs, one piece nozzles**

Set 6 bocchette unipezzo  
Tüllen Set 6 Stk. aus einem Stück gezogen  
Set 6 pcs douilles monobloc  
Surtido 6 boquillas monobloc

| art.     | Ø mm. | stars |
|----------|-------|-------|
| 47208-21 | 18    | 5     |
| 47208-22 | 18    | 6     |
| 47208-23 | 18    | 7     |
| 47208-24 | 18    | 8     |



**Set 6 pcs, one piece nozzles**

Set 6 bocchette unipezzo  
Tüllen Set 6 Stk. aus einem Stück gezogen  
Set 6 pcs douilles monobloc  
Surtido 6 boquillas monobloc

| art.     | Ø mm. | stars |
|----------|-------|-------|
| 47354-02 | 2     | 6     |
| 47354-04 | 4     | 6     |
| 47354-06 | 6     | 6     |
| 47354-08 | 8     | 6     |
| 47354-10 | 10    | 6     |
| 47354-12 | 12    | 7     |
| 47354-14 | 14    | 8     |
| 47354-16 | 16    | 9     |
| 47354-18 | 18    | 10    |

**Set 6 pcs, one piece nozzles**

Set 6 bocchette unipezzo  
Tüllen Set 6 Stk. aus einem Stück gezogen  
Set 6 pcs douilles monobloc  
Surtido 6 boquillas monobloc

| art.     | Ø mm. | stars |
|----------|-------|-------|
| 47355-02 | 2,5   | 6     |
| 47355-04 | 4,0   | 6     |
| 47355-06 | 6,0   | 6     |
| 47355-08 | 8,0   | 7     |
| 47355-10 | 10    | 8     |
| 47355-12 | 12    | 10    |

**Set 6 pcs, one piece nozzles**

Set 6 bocchette unipezzo  
Tüllen Set 6 Stk. aus einem Stück gezogen  
Set 6 pcs douilles monobloc  
Surtido 6 boquillas monobloc

| art.     | Ø mm. | stars |
|----------|-------|-------|
| 47356-02 | 2,0   | 5     |
| 47356-04 | 4,0   | 9     |
| 47356-06 | 5,5   | 9     |
| 47356-08 | 7,0   | 10    |
| 47356-10 | 8,5   | 12    |
| 47356-12 | 13,0  | 15    |
| 47356-14 | 14,5  | 16    |
| 47356-16 | 16,0  | 17    |
| 47356-18 | 17,5  | 18    |



**Set 6 pcs, one piece nozzles**

Set 6 bocchette unipezzo  
Tüllen Set 6 Stk. aus einem Stück gezogen  
Set 6 pcs douilles monobloc  
Surtido 6 boquillas monobloc

| art.     | Ø mm. |
|----------|-------|
| 47353-02 | 2     |
| 47353-04 | 4     |
| 47353-06 | 6     |
| 47353-08 | 8     |
| 47353-10 | 10    |
| 47353-12 | 12    |
| 47353-14 | 14    |
| 47353-16 | 16    |
| 47353-18 | 18    |
| 47353-20 | 20    |
| 47353-22 | 22    |
| 47353-24 | 24    |

**Set 6 pcs, one piece nozzles**

Set 6 bocchette unipezzo  
Tüllen Set 6 Stk. aus einem Stück gezogen  
Set 6 pcs douilles monobloc  
Surtido 6 boquillas monobloc

| art.     | Ø mm. |
|----------|-------|
| 47207-20 | 20    |
| 47207-25 | 25    |
| 47207-30 | 30    |

**Set 10 pcs Bismark nozzles**

Set 10 bocchette a imbuto  
Fülltüllen Set 10 Stk.  
Set 10 douilles à choux  
Surtido 10 boquillas para relleno

| art.     | Ø mm. | l. mm. |
|----------|-------|--------|
| 47127-04 | 4     | 90     |
| 47127-06 | 6     | 75     |
| 47127-08 | 8     | 90     |



**Nozzle**  
Bocchetta decorativa  
Spritztülle  
Douille  
Boquilla

| art.     | Ø mm. | h. cm. |
|----------|-------|--------|
| 47357-50 | 55    | 6      |



**Nozzle**  
Bocchetta decorativa  
Spritztülle  
Douille  
Boquilla

| art.     | Ø mm. | h. cm. |
|----------|-------|--------|
| 47357-51 | 55    | 5,6    |



**Nozzle**  
Bocchetta decorativa  
Spritztülle  
Douille  
Boquilla

| art.     | Ø mm. | h. cm. |
|----------|-------|--------|
| 47357-40 | 32    | 6,0    |
| 47357-41 | 32    | 5,7    |
| 47357-42 | 32    | 5,7    |
| 47357-43 | 32    | 5,7    |
| 47357-44 | 32    | 5,7    |



**PP**

**Set of 6 nozzles**  
Set 6 bocchette  
Tüllen Set, 6 Stk  
Set 6 douilles  
Juego 6 boquillas

| art.     | Ø mm.          |
|----------|----------------|
| 47214-86 | 5-7-9-11-13-15 |



**PP**

**Set of 6 nozzles**  
Set 6 bocchette  
Tüllen Set, 6 Stk  
Set 6 douilles  
Juego 6 boquillas

| art.     | Ø mm.         |
|----------|---------------|
| 47215-86 | 3-5-7-9-11-13 |



**PP**

**Set of 8 nozzles**  
Set 8 bocchette  
Tüllen Set, 8 Stk  
Set 8 douilles  
Juego 8 boquillas

|          |
|----------|
| 47216-88 |
|----------|



**PP**

**Set of 12 nozzles**  
Set 12 bocchette  
Tüllen Set, 12 Stk  
Set 12 douilles  
Juego 12 boquillas

| art.     | Ø mm. |
|----------|-------|
| 47618-10 | 2>10  |
| 47618-20 | 10>20 |



**PC**

**Set of 12 nozzles**  
Set 12 bocchette  
Tüllen Set, 12 Stk  
Set 12 douilles  
Juego 12 boquillas

|          |
|----------|
| 47250-12 |
|----------|

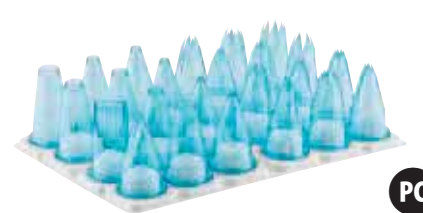

**PC**

**Set of 24 nozzles**  
Set 24 bocchette  
Tüllen Set, 24 Stk  
Set 24 douilles  
Juego 24 boquillas

|          |
|----------|
| 47250-24 |
|----------|



**Flower nozzles 12 pcs**

Bocchette floreali 12 pz

Spritztüllen 12 Stk

Douille fleurs 12 pcs

Boquillas florales 12 pz

art.

47357-38



**Set of 29 nozzles**

Set 29 bocchette

Tüllen Set, 29 Stk

Set 29 douilles

Juego 29 boquillas

art.

47219-29



**Set of 38 nozzles**

Set 38 bocchette

Tüllen Set, 38 Stk

Set 38 douilles

Juego 38 boquillas

art.

47219-38



**Set of 55 nozzles**

Set 55 bocchette

Tüllen Set, 55 Stk

Set 55 douilles

Juego 55 boquillas

art.

47219-55

**26 tubes, 2 flower nails, 1 standard coupler. – 26 bocchette, 2 chiodi per fiori, 1 adattatore standard.**

**35 tubes, 1 medium coupler, 1 large coupler. 35 bocchette, 1 adattatore medio, 1 grande.**

**52 tubes, 2 flower nails, 1 standard coupler. – 52 bocchette, 2 chiodi per fiori, 1 adattatore standard.**



**Set of 13 assorted nozzles**

Set 13 bocchette assortite

Tüllensortiment, 13 Stk

Set 13 douilles assorties

Juego 13 boquillas

art.

47251-00

**8 tubes mm. 1/2/3/5/7/9/13/15, 2 adapters, 2 lids, 1 brush. 8 bocchette mm. 1/2/3/5/7/9/13/15, 2 adattatori, 2 tappi, 1 bruschino.**

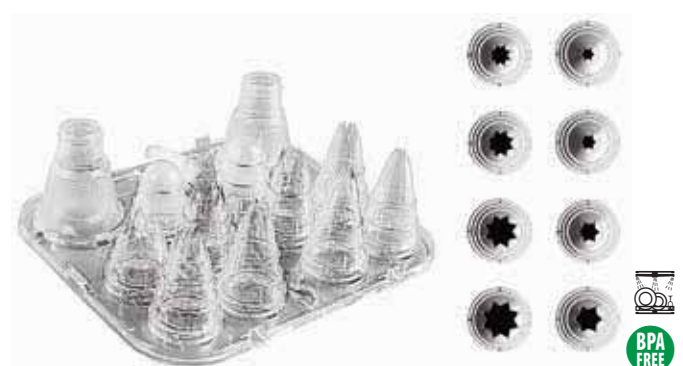

**Set of 13 assorted nozzles**

Set 13 bocchette assortite

Tüllensortiment, 13 Stk

Set 13 douilles assorties

Juego 13 boquillas

art.

47251-01

**8 star tubes mm. 4/5/7/9 (6 points), 7/9/11/13 (8 points), 2 adapters, 2 lids, 1 brush. – 8 bocchette foro stella mm. 4/5/7/9 (6 punte), 7/9/11/13 (8 punte), 2 adattatori, 2 tappi, 1 bruschino.**



**Set of 13 assorted nozzles**

Set 13 bocchette assortite  
Tüllensortiment, 13 Stk  
Set 13 douilles assorties  
Juego 13 boquillas

art. 47251-02

**8 tubes, 1 bismark tube, 2 adapters, 2 lids.**

8 bocchette, 1 bocchetta a imbuto, 2 adattatori, 2 tappi.



**Set of 13 assorted nozzles**

Set 13 bocchette assortite  
Tüllensortiment, 13 Stk  
Set 13 douilles assorties  
Juego 13 boquillas

art. 47251-03

**8 star tubes mm. 4,5/5,5/6/7,5/8/8/9/10, 2 adapters, 2 lids, 1 brush. – 8**

bocchette foro stella mm. 4,5/5,5/6/7,5/8/8/9/10, 2 adattatori, 2 tappi, 1 bruschino.



**External piping tip adapter**

Adattatore per bocchette  
Adapter für Spritztüllen  
Adaptateur à douilles  
Adaptador para boquillas

art. Ø mm. des.  
47212-01 18 STANDARD



**External piping tip adapter**

Adattatore per bocchette  
Adapter für Spritztüllen  
Adaptateur à douilles  
Adaptador para boquillas

art. Ø mm. des.  
47212-02 25-31 MEDIUM



**External piping tip adapter**

Adattatore per bocchette  
Adapter für Spritztüllen  
Adaptateur à douilles  
Adaptador para boquillas

art. Ø mm. des.  
47212-03 36 LARGE



**Nozzles adapter, 2 pcs**

Adattatori per bocchette, 2 pz  
Spritztüllen-Adapter, 2 Stk  
Adaptateurs à douilles, 2 pièces  
Adaptadores boquillas, 2 piezas

art. 47212-05

**To prepare decorations with 2 or 3 colours.  
Suitable for piping tips Ø30 h 50 mm.**

Per decorazioni a 2 o 3 colori. Adatte a bocchette Ø30 h 50 mm.



**Pastry tube brush, 6 pcs**

Bruschino per bocchette, 6 pz  
Tüllen-Bürste, 6 Stk  
Brosse à douilles, 6 pcs  
Cepillo para boquillas, 6 pz

art. Ø cm. l. cm.  
47200-01 0,8 10  
47200-02 0,5-2,4 12,5





**Cream roll molds, 10 pcs**

Cannoli, 10 pz  
Sahnerolle, konisch/gerade, 10 Stk  
Rouleau à fromage, 10 pcs  
Rodillos queso, 10 pz

| art.     | Ø mm. | l. mm. |
|----------|-------|--------|
| 47020-15 | 15    | 92     |
| 47020-20 | 22    | 142    |
| 47020-30 | 10-25 | 139    |
| 47020-35 | 20-25 | 171    |



**Cream horn molds, 10 pcs**

Cornetti, 10 pz  
Schillerlockenform, 10 Stk  
Moulet à cornet, 10 pcs  
Moldes para conos, 10 pz

| art.     | Ø mm. | l. mm. |
|----------|-------|--------|
| 47021-35 | 34    | 110    |
| 47021-45 | 47    | 161    |



**Cream horn molds, 10 pcs**

Cornetti, 10 pz  
Schillerlockenform, 10 Stk  
Moulet à cornet, 10 pcs  
Moldes para conos, 10 pz

| art.     | cm.  |
|----------|------|
| 47021-30 | 3x12 |



**Decorating set 8 pcs**

Kit decoro 8 pezzi  
Dekorations-Set, 8-teilig  
Set 8 pcs à décorer  
Juego 8 piezas para decorar

| art.     |
|----------|
| 47120-01 |

**6 small tubes, 1 standard coupler, 1 bag cm. 35**  
6 bocchette piccole, 1 adattatore standard, 1 sacchetto 35 cm.



**Decorating set 8 pcs**

Kit decoro 8 pezzi  
Dekorations-Set, 8-teilig  
Set 8 pcs à décorer  
Juego 8 piezas para decorar

| art.     |
|----------|
| 47120-02 |

**6 medium tubes, 1 medium coupler, 1 bag cm. 40.** – 6 bocchette medie, 1 adattatore medio, 1 sacchetto 40 cm.



**Icing bag**

Sacchetto per decorare  
Spritzbeutel  
Sac à dresser  
Mangas para decorar

| art.     | h. cm. | U. Pack |
|----------|--------|---------|
| 47106-28 | 28     | 6       |
| 47106-34 | 34     | 6       |
| 47106-40 | 40     | 6       |
| 47106-46 | 46     | 6       |
| 47106-50 | 50     | 6       |

**Synthetic fibre with multi-layer water-proof plastic coating.**



**Icing bag**

Sacchetto per decorare  
Spritzbeutel  
Sac à dresser  
Mangas para decorar

| art.     | h. cm. | U. Pack |
|----------|--------|---------|
| 47106-55 | 55     | 6       |
| 47106-60 | 60     | 6       |
| 47106-65 | 65     | 6       |
| 47106-70 | 70     | 6       |
| 47106-75 | 75     | 6       |

**Fibra sintetica con rivestimento a strati in plastica impermeabile.**



**Icing bag**

Sacchetto per decorare  
Spritzbeutel  
Sac à dresser  
Mangas para decorar

| art.     | h. cm. | U. Pack |
|----------|--------|---------|
| 47105-28 | 28     | 6       |
| 47105-34 | 34     | 6       |
| 47105-40 | 40     | 6       |
| 47105-46 | 46     | 6       |
| 47105-50 | 50     | 6       |

**With reinforced tip, seam and hanger. Cotton with multi-layer water-proof plastic coating.**



**Icing bag**

Sacchetto per decorare  
Spritzbeutel  
Sac à dresser  
Mangas para decorar

| art.     | h. cm. | U. Pack |
|----------|--------|---------|
| 47105-55 | 55     | 6       |
| 47105-60 | 60     | 6       |
| 47105-65 | 65     | 6       |
| 47105-70 | 70     | 6       |
| 47105-75 | 75     | 6       |

**Con punta rinforzata, orlo e gancio. Cotone con rivestimento a strati in plastica impermeabile.**





**Icing bag**

Sacchetto per decorare  
Spritzbeutel  
Sac à dresser

Mangas para decorar

| art.     | h. cm. | U. Pack |
|----------|--------|---------|
| 47119-30 | 30     | 6       |
| 47119-35 | 35     | 6       |
| 47119-40 | 40     | 6       |
| 47119-45 | 45     | 6       |
| 47119-50 | 50     | 6       |
| 47119-60 | 60     | 6       |

**With reinforced tip, seam and hanger. Polyurethan with nylon coating. High frequency electric seaming.** – Con punta rinforzata, orlo e gancio. Poliuretano con rivestimento in nylon. Saldatura ad alta frequenza.



**Double pastry bag**

Sacchetto per decorare doppio  
Doppeldressierbeutel  
Sac à dresser, double

Mangas para decorar, doble

| art.     | my | cm.       | pcs/pz |
|----------|----|-----------|--------|
| 47104-45 | 70 | 45,5x30,5 | 75     |

**Disposable. For 2 ingredients. Closed tip, can be used without tube.**

Monouso. Per 2 ingredienti. Punta chiusa, può essere utilizzato senza bocchette.

**PE**



**PE**

**Disposable icing bag**

Sacchetto per decorare, monouso  
Einwegspritzbeutel  
Sac à dresser jetable  
Mangas desechables

| art.     | my | h. cm. | pcs/pz |
|----------|----|--------|--------|
| 47118-30 | 80 | 30     | 100    |
| 47118-40 | 80 | 40     | 100    |
| 47118-55 | 80 | 55     | 100    |
| 47118-65 | 80 | 65     | 100    |



**PE**

**Disposable icing bag**

Sacchetto per decorare, monouso  
Einwegspritzbeutel  
Sac à dresser jetable  
Mangas desechables

| art.     | my | h. cm. | pcs/pz |
|----------|----|--------|--------|
| 47111-30 | 80 | 30     | 100    |
| 47111-40 | 80 | 40     | 100    |
| 47111-46 | 80 | 55     | 100    |
| 47111-55 | 80 | 65     | 100    |



**NEW**

**PE**

**Disposable icing bag**

Sacchetto per decorare, monouso  
Einwegspritzbeutel  
Sac à dresser jetable  
Mangas desechables

| art.     | my  | h. cm. | pcs/pz |
|----------|-----|--------|--------|
| 47114-40 | 100 | 40     | 80     |
| 47114-55 | 100 | 55     | 80     |



**Icing bag, polyurethane**

Sacchetto per decorare, poliuretano  
Spritzbeutel, Polyurethan  
Sac à dresser, polyuréthane  
Mangas para decorar, poliuretano

| art.     | h. cm. |
|----------|--------|
| 47112-34 | 34     |
| 47112-45 | 45     |
| 47112-50 | 50     |



**BPA FREE**

**PP**

**Bag clip**

Clip chiudi sacco  
Verschluss-Clip  
Clip ferme sachet  
Pinza cierra bolsas

| art.     | cm. | pcs/pz |
|----------|-----|--------|
| 42908-24 | 21  | 1      |

**Freezer, dishwasher and microwave safe. Safe to use with food.** – Idonei ad uso in freezer, lavastoviglie e microonde. Per alimenti.



**SS**

**Cookie press and icing set 20 pcs**

Siringa per pasticceria, set 20 pezzi  
Gebäckspritze-Satz, 20 Stk.  
Seringue à biscuits, jeu 20 pcs  
Juego pistola repostería, juego 20 pcs.

| art.     | ml. |
|----------|-----|
| 47010-20 | 250 |

**For a correct use of the syringe we suggest shortbread dough.** – Per un utilizzo ottimale della siringa suggeriamo la frolla montata.

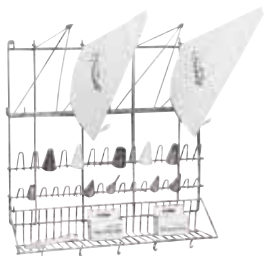

SS

**Icing bags & nozzles wall rack**  
Espositore sacchetti/bocchette  
Spritzbeutel-/ u. Tüllenaufhänger  
Séchoir à poche et douilles  
Secador mangas y boquillas

art. dim. cm.  
47113-03 50x42x50



SS

**Wall rack for icing bags**  
Espositore per sacchetti  
Spritzbeutelaufräger  
Séchoir à poche  
Secador cuelga-mangas

art. dim. cm.  
47107-00 50x42x26

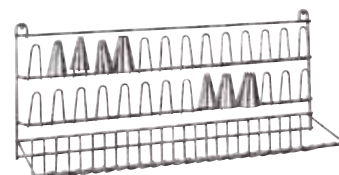

SS

**Wall rack for nozzles**  
Espositore per bocchette  
Tüllenaufhänger  
Séchoir à douilles  
Secador boquillas

art. dim. cm.  
47108-00 50x13x24



PP

**Icing bag holder**  
Vaso porta sacchetto  
Spritzbeutel-Absetzständer  
Support à poches  
Soporte para mangas

art. Ø cm. h. cm.  
47110-23 19,5 23



**Cake plate, swivel base, aluminum**  
Girello, alluminio  
Tortendrehplatte, aluminium  
Guéridon plaque tournante, alu  
Pedestal giratorio para tartas, aluminio

art. Ø cm. h. cm.  
47101-30 30 10



**Cake plate, swivel base, aluminum**  
Girello, alluminio  
Tortendrehplatte, aluminium  
Guéridon plaque tournante, alu  
Pedestal giratorio para tartas, aluminio

art. dim. cm.  
47101-40 30x40x10



MF

**Cake-plate, swivel base**  
Girello per decorazione torte  
Tortendrehplatte  
Guéridon plaque tournante  
Pedestal giratorio para tartas

art. Ø cm. h. cm.  
47103-32 32 10



PE

**Protection cover**  
Campana  
Abdeckhauben  
Cloche  
Tapa

art. Ø cm. h. cm.  
47103-30 30 12



SS

**Cake peel**  
Pala per torte  
Tortenschaufel  
Pelle à tarte  
Pala para tartas

art. Ø cm. dim. cm.  
47094-30 30 27x26



**Doilies**  
Pizzi sottotorta  
Tortenspitzen, Rosendekor  
Dentelles décor rose  
Blondas

art. dim. cm. pcs/pz  
47687-24 18-25 250



**Doilies**  
Pizzi sottotorta  
Tortenspitzen, Rosendekor  
Dentelles décor rose  
Blondas

art. dim. cm. pcs/pz  
47686-10 6-10 250  
47686-12 6,5-12 250  
47686-14 8-14 250  
47686-17 9,5-16,5 250  
47686-22 12,5-22 100  
47686-24 15-24 100



**Doilies**  
Pizzi sottotorta  
Tortenspitzen, Rosendekor  
Dentelles décor rose  
Blondas

art. dim. cm. pcs/pz  
47686-26 16-27 100  
47686-30 19-30 100  
47686-33 20-32 100  
47686-36 32-36 100  
47686-42 25-42 100



**Draining rack**  
Griglia di colaggio  
Überziehgitter  
Grille à glacer  
Rejilla

| art.     | dim. cm. |
|----------|----------|
| 44430-60 | 60x40    |

**Frame ø mm 5, 2 cross-bars, 29 wires ø 2 mm.**  
Quadro ø mm 5, 2 traverse, 29 fili ø 2 mm.



**Draining rack**  
Griglia di colaggio  
Überziehgitter  
Grille à glacer  
Rejilla

| art.     | dim. cm. |
|----------|----------|
| 44430-61 | 60x40    |

**Frame ø mm 6, 2 cross-bars, 24 wires ø 3 mm.**  
Quadro ø mm 6, 2traverse, 24 fili ø 3 mm.



**Draining rack**  
Griglia di colaggio  
Überziehgitter  
Grille à glacer  
Rejilla

| art.     | dim. cm.    |
|----------|-------------|
| 44431-46 | 46x30,5x2,5 |
| 44431-60 | 60x40x2,5   |

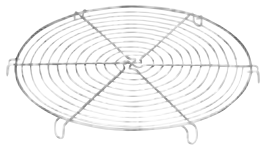

**Cake cooling tray, chromed**  
Griglia di raffreddamento, cromata  
Tortengitter, verchromt  
Grille ronde à tourte, chromé  
Rejilla para tortas, cromada

| art.     | Ø cm. |
|----------|-------|
| 47098-18 | 18,5  |
| 47098-22 | 22,0  |
| 47098-26 | 26,0  |
| 47098-30 | 30,0  |



**Baking tray, aluminum**  
Teglia, alluminio  
Backblech, Aluminium  
Plaque à cuisson, aluminium  
Placa pastelería, aluminio

| art.     | GN  | dim. cm.  |
|----------|-----|-----------|
| 41744-32 | 1/1 | 32,5x53x1 |
| 41744-53 | 2/1 | 53x65x1   |
| 41744-60 | -   | 60x40x1   |



**Baking tray, perforated, aluminum**  
Teglia forata, alluminio  
Backblech, Aluminium, gelocht  
Plaque perforée, aluminium  
Placa pastelería perforada, aluminio

| art.     | GN  | dim. cm.  |
|----------|-----|-----------|
| 41756-30 | -   | 30x40x1   |
| 41756-32 | 1/1 | 32,5x53x1 |
| 41756-53 | 2/1 | 53x65x1   |
| 41756-60 | -   | 60x40x1   |



**Baking tray, alusteel**  
Teglia rettangolare, alluminata  
Backblech mit Aluminiumüberzug  
Plaque, tôle aluminitée  
Placa pastelería, aluminizada

| art.     | dim. cm. |
|----------|----------|
| 41746-60 | 60x40x2  |



**Baking tray, alusteel**  
Teglia rettangolare, alluminata  
Backblech mit Aluminiumüberzug  
Plaque, tôle aluminitée  
Placa pastelería, aluminizada

| art.     | dim. cm. |
|----------|----------|
| 41751-30 | 30x23x3  |
| 41751-35 | 35x28x3  |
| 41751-40 | 40x30x3  |
| 41751-50 | 50x35x3  |
| 41751-60 | 60x40x3  |
| 41751-65 | 65x45x3  |



**Baking tray, non stick coated**

Teglia rettangolare, antiaderente  
Backblech mit Antihftbeschichtung  
Plaque revêtement anti-adhésif  
Placa pastelería anti-adherente

| art.     | dim. cm. |
|----------|----------|
| 41747-60 | 60x40x2  |



**Baking tray, silicone coated**

Teglia, siliconata  
Backblech, Silikonbeschichtet  
Plaque, revêtement silicone  
Placa pastelería siliconada

| art.     | GN  | dim. cm.  |
|----------|-----|-----------|
| 41743-32 | 1/1 | 32,5x53x1 |
| 41743-53 | 2/1 | 53x65x1   |
| 41743-60 | -   | 60x40x1   |



**Baking tray, perforated, silicone coated**

Teglia forata, siliconata  
Backblech, gelocht, Silikonbeschichtet  
Plaque perforée, revêtement silicone  
Placa perforada siliconada

| art.     | GN  | dim. cm.  |
|----------|-----|-----------|
| 41753-30 | -   | 30x40x1   |
| 41753-32 | 1/1 | 32,5x53x1 |
| 41753-53 | 2/1 | 53x65x1   |
| 41753-60 | -   | 60x40x1   |



**Bread mold, blue steel**

Bacinella carré, ferro blu  
Brotform, Blaublech  
Pain de mie, tôle bleuie  
Molde, hierro

| art.     | dim. cm. |
|----------|----------|
| 41748-20 | 20x10x10 |
| 41748-30 | 30x10x10 |
| 41748-35 | 35x10x10 |
| 41748-40 | 40x10x10 |
| 41748-50 | 50x10x10 |



**Bread mold, alu-steel**

Bacinella carré, alluminata  
Brotform mit Aluminiumüberzug  
Pain de mie, tôle aluminisée  
Molde, acero aluminizado

| art.     | dim. cm. |
|----------|----------|
| 41750-20 | 20x10x10 |
| 41750-30 | 30x10x10 |
| 41750-40 | 40x10x10 |
| 41750-41 | 40x15x15 |
| 41750-50 | 50x10x10 |



**Confectionery funnel**

Imbuto colatore  
Likör- u. Fondanttrichter  
Entonnoir à fondant  
Embudo colador

| art.     | Ø cm. | h. cm. | lt. |
|----------|-------|--------|-----|
| 47800-22 | 22    | 21     | 2   |

**Supplied with 3 nozzles ø 2, 4, 6 mm.**  
Con 3 bocchette ø 2, 4, 6 mm.



**Confectionery funnel**

Imbuto colatore  
Likör- u. Fondanttrichter  
Entonnoir à fondant  
Embudo colador

| art.     | Ø cm. | h. cm. | lt. |
|----------|-------|--------|-----|
| 47801-20 | 14    | 20     | 0,9 |

**Supplied with 3 nozzles ø 4, 6, 7,5 mm.**  
Con 3 bocchette ø 4, 6, 7,5 mm.



**Cream dispenser**

Dosa creme  
Dosierer  
Doseur à crème  
Dosificador

| art.     | dim. cm. |
|----------|----------|
| 47612-01 | 20x16x23 |



**Cream injector, cast aluminum**

Dosatrice per creme, alluminio pressofuso  
Gebäkfüllmaschine  
Entonnoir à crème  
Dosificador de porciones

| art.     | dim. cm. | lt. |
|----------|----------|-----|
| 47694-03 | 44x25    | 3   |

**Funnel, cylinder, piston, injector, lever and thrust rib in s/s. Piston: ø 24 mm. Doses: 1-12 gr.**  
Imbuto, cilindro, pistone, iniettore, leva e nasello di spinta in acciaio inox. Pistone: ø 24 mm. Dosi: 1-12 gr.

SS

PC

SS



**Caramelising rod**  
Caramellizzatore  
Caramelisier-Eisen  
Fer à caraméliser  
Quemador

| art.     | Ø cm. |
|----------|-------|
| 47846-10 | 10,5  |



**Electric caramelising rod**  
Caramellizzatore elettrico  
Caramelisier-Eisen, elektrisch  
Fer à caraméliser électrique  
Quemador eléctrico

| art.     | Ø cm. | kW   |
|----------|-------|------|
| 47847-10 | 10    | 0,65 |
| 47847-12 | 12    | 1,00 |



**Electric caramelising rod**  
Caramellizzatore elettrico  
Caramelisier-Eisen, elektrisch  
Fer à caraméliser électrique  
Quemador eléctrico

| art.     | l. cm. | kW  |
|----------|--------|-----|
| 47847-23 | 23     | 1,5 |



**Electric spray gun**  
Pistola elettrica  
Sprühpistole, elektrisch  
Pistolet électrique  
Pistola eléctrica

| art.     | ml. | W  |
|----------|-----|----|
| 47848-07 | 700 | 60 |

**Bar 0-160, rpm 250 - For butter, oil, fat, wax, jelly, jam, chocolate, releasing agents and emulsions. Usable for hot liquids max. 65 °C. Nozzle 0,6 mm.** – Per burro, oli, cera, gelatina, marmellata, cioccolata, antiagglomeranti ed emulsionanti. Per liquidi caldi max. 65°C. Bocchetta 0,6 mm.



**Airbrush compressor**  
Compressore per penna aerografa  
Airbrush Kompressor  
Compresseur  
Compresor

| art.     | dim. cm. | kW  |
|----------|----------|-----|
| 47844-06 | 16x30x23 | 0,2 |

**Bar 4.**



**Airbrush, double action**  
Penna aerografa, doppia azione  
Airbrush-Pistole, Doppelaktion  
Aérographe, dual action  
Equipo aerógrafo, doble acción

| art.     | Ø mm. | cap.  |
|----------|-------|-------|
| 47844-02 | 0,3   | 7 cm3 |



**Airbrush stand**  
Supporto penna aerografa  
Airbrush-Pistole Gestell  
Support aérographe  
Soporte aerógrafo

| art.     |
|----------|
| 47844-01 |



**Sugar lamp**  
Lampada per zucchero  
Zuckerlampe  
Lampe à sucre  
Lámpara para azúcar

| art.     | dim. cm. |
|----------|----------|
| 47840-11 | 61x41x50 |

**Infrared lamp, 3 selection powers 500-1000-1500W. Cable included.** – Lampada infrarossi con 3 potenze selezionabili, 500-1000-1500W. Incl. cavo di alimentazione.





NEW  
ABS

**Tempering unit**

Temperatrice  
Temperiergerät  
Tempereuse  
Templadora

art. Ø cm. h. cm. lt.  
47698-01 20,5 21,2 1,7

**Ideal for chocolate coatings of ice creams on sticks. Removable anodized aluminum tank.**  
Ideale per coperture in cioccolato di gelati su stecco. Vasca estraibile in alluminio anodizzato.



NEW  
ABS

**Tempering unit**

Temperatrice  
Temperiergerät  
Tempereuse  
Templadora

art. Ø cm. h. cm. lt.  
47698-02 26 16 1,8

**Mini dry melter, allows to process tiny chocolate quantities. Practical removable tank.**  
Mini scioglitore a secco, adatto per piccole produzioni. Pratica vasca estraibile



SS  
ABS

**Tempering unit**

Temperatrice  
Temperiergerät  
Tempereuse  
Templadora

art. dim. cm. lt.  
47698-03 40x24x13,5 3,6  
47698-06 40x33x13,5 6,0

**Analog tempering units. Different wirings upon request.** – Temperatrici analogiche. Su richiesta cablaggio: GB/USA/GIAPPONE/AUSTRALIA/CINA.



NEW  
ABS  
SS

**Tempering unit, digital**

Temperatrice digitale  
Temperiergerät, digital  
Tempereuse digitale  
Templadora digital

art. dim. cm. lt.  
47698-07 40x33x13,5 6,0

**With thermal probe. Tempering manually adjustable or following the 3 programs: white, milk and dark chocolate.** – Con sonda termica. Temperaggio regolabile manualmente o seguendo i 3 programmi per cioccolato bianco, al latte e fondente.



**Chef's torch**

Cannello professionale  
Profı-Wärmepistole  
Chalumeau de cuisine  
Soplete cocina

art. dim. cm. ml.  
47841-03 8x7x16 200



**Chef's torch**

Cannello professionale  
Profı-Wärmepistole  
Chalumeau de cuisine  
Soplete cocina

art. dim. cm. ml.  
47841-04 12x7x18 280



**Sugar bulb**

Pompetta con terminale in rame  
Blaszuckerspritze  
Poire à sucre soufflé  
Pera para azúcar soplado

art.  
47838-00



NEW

**Sugar/jam thermometer**

Termometro per zucchero/marmellata  
Zucker- und Marmeladenthermometer  
Thermomètre à sucre et confiture  
Termómetro azúcar y mermelada

art. scala °C  
47843-05 2°C +40+200°C

**Brass.** – Ottone. Dim. 4,7x20 cm.



SS

**Sugar thermometer**

Termometro per zucchero  
Zuckerthermometer  
Thermomètre à sucre  
Termometro para azúcar

art. scala °C  
47843-00 1°C +80+200



SS

**Sugar thermometer holder**

Reggi caramellometro  
Zuckerthermometer-Träger  
Support pour thermomètre à sucre  
Soporte para termometro azúcar

| art.     | h. cm. |
|----------|--------|
| 47842-00 | 32     |



**Syrup density meter test tube**

Provetta alimentare graduata, plastica  
Sirup-Hydrometer-Becher  
Epruvette pèse-sirop  
Probeta aerómetro

| art.     | Ø cm. | h. cm. | ml. |
|----------|-------|--------|-----|
| 49703-01 | 3     | 25     | 100 |

**Can be sterilized up to 120°C.**  
Sterilizzabile fino a 120°C.



**Syrup density meter**

Pesa sciropo (densimetro)  
Sirup-Hydrometer  
Pèse-sirop  
Aerómetro

| art.     | l. cm. |
|----------|--------|
| 49703-00 | 12,5   |

**Temp.: 20°C - gr./ml./°Bé: 1.100/1.400/15-40 - Div.: 0,010 g/ml/2°Bé**



PA+  
plus

**Angular spatula**

Spatola angolare  
Winkelpalette  
Spatule angulaire  
Espátula angular

| art.     | l. cm. |
|----------|--------|
| 12909-12 | 12     |
| 12909-23 | 23     |



ABS

**Smoother**

Stendipasta  
Teig-Glätter  
Lisse-pâte  
Espátula para alisar

| art.     | dim. cm. |
|----------|----------|
| 47627-01 | 16x8     |



**Biscuit spatula**

Spatola per biscuit  
Biscuit-Spachtel  
Spatule à biscuit  
Espátula para biscuit

| art.     | l. cm. |
|----------|--------|
| 47626-55 | 55,5   |



**Ruler**

Riga  
Lineal  
Règle  
Regla

| art.     | l. cm. |
|----------|--------|
| 47033-50 | 60     |

**5 divisions cm 12 and 7 divisions cm 8.**  
5 divisioni 12 cm e 7 da 8 cm.



**Cake slicer**

Lira per pan di Spagna  
Tortendrahtschneider  
Lyre à genoise  
Cortador de pasteles

| art.     | Ø cm. | h. cm. |
|----------|-------|--------|
| 47031-44 | 30    | 20>60  |



**Cake slicer, 3 cutting wires**

Lira per pan di Spagna, 3 fili  
Tortendrahtschneider, 3 Drähte  
Lyre à genoise, 3 lames  
Cortador de pasteles 3 alambres

| art.     | Ø cm. | h. cm. |
|----------|-------|--------|
| 47031-46 | 46    | 10>90  |





#### Mini guitar

Chitarra mini, 12  
Praliné-Schneideapparat  
Appareil à couper les pralinés  
Cortador para pasteles

art. dim. cm.

47692-03 24x24

**Includes a 22 mm frame and s/steel plate, 1 plastic spatula and accessories for maintenance. Do not use for frozen pies, chocolate bars or generally hard paste. – Include un telaio da 22 mm e piatto inox, 1 spatola plastica, accessori per la manutenzione. Non usare per torte congelate, tavolette di cioccolato, impasti duri in genere.**



#### Base for ganache and 4 frames

Base per ganache + 4 telai  
Basis und 4 Rahmen für Ganache  
Base et 4 cadres à ganache  
Base y 4 cuadros para ganache

art. dim. cm.

47693-00 39x45x13

**Includes 2 frames 3 mm, 2 frames 5 mm, 1 spatula and Teflon base. Ganache's size 24x24 cm. – Include 2 telai 3 mm, 2 telai 5 mm, 1 spatola e base in teflon. Misura ganache 24x24 cm.**

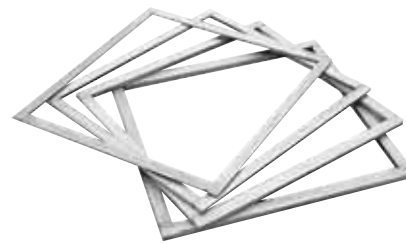

SS

#### Frames

Quadri per ganache  
Rahmen  
Cadres  
Cuadros

art. dim. cm. int. cm.

47693-03 40x40x0,3 36x36

47693-05 40x40x0,5 36x36

47693-10 40x40x1,0 36x36

47693-15 40x40x1,5 36x36



#### Guitar

Chitarra  
Praliné-Schneideapparat  
Appareil à couper les pralinés  
Cortador para pasteles

art. dim. cm.

47692-01 39x45x13

**PST plastic base, 3 stainless steel cutting frames of 22,5 - 30 and 45 mm. Including 1 s/s sheet, plastic spatula, 3 spare wires, 2 wires fixing spanners. Base in PST, 4 telai inox da 22,5 - 30 e 45 mm. Inclusi 1 piatto inox, racla in PST, 3 fili di ricambio, 2 chiavi per fissaggio dei fili.**



#### Double guitar

Chitarra doppia  
Praliné-Schneideapparat  
Appareil à couper les pralinés  
Cortador para pasteles

art. dim. cm.

47692-02 39x45x13

**PST base, 4 stainless steel cutting frames of 22,5 - 30 - 45 mm. and fixed side cutting frame 30 mm. Including 1 s/s sheet, plastic spatula, 3 spare wires, 2 wires fixing spanners. – Base in PST, 4 telai inox da 22,5 - 30 - 45 e laterale fisso da 30 mm. Inclusi 1 piatto inox, racla in PST, 3 fili di ricambio, 2 chiavi per fissaggio dei fili.**





SS

**Expanding pastry cutter**

Tagliapasta estensibile

Teigschneider

Rouleau extensible

Cortapastas extensible

| art.     | Ø cm. | l. cm. |
|----------|-------|--------|
| 47820-05 | 5,5   | 24     |
| 47820-07 | 5,5   | 24     |



SS

**Expanding pastry cutter**

Tagliapasta estensibile

Teigschneider

Rouleau extensible

Cortapastas extensible

| art.     | Ø cm. |
|----------|-------|
| 47830-05 | 9,5   |
| 47830-07 | 9,5   |



SS

**Expanding pastry cutter**

Tagliapasta estensibile

Teigschneider

Rouleau extensible

Cortapastas extensible

| art.     | Ø cm. | l. cm. |
|----------|-------|--------|
| 47821-05 | 5,5   | 24     |
| 47821-07 | 5,5   | 24     |



SS

**Expanding pastry cutter**

Tagliapasta estensibile

Teigschneider

Rouleau extensible

Cortapastas extensible

| art.     | Ø cm. | l. cm. |
|----------|-------|--------|
| 47822-05 | 5,5   | 28     |
| 47822-07 | 5,5   | 28     |



SS

**Pastry wheel, plain**

Rotella taglia pasta liscia

Teigrädchen, glatt

Roulette à pâte lisse

Ruleta cortapasta

| art.     | Ø cm. | l. cm. |
|----------|-------|--------|
| 18325-01 | 5,5   | 18     |



SS

**Pastry wheel, fluted**

Rotella taglia pasta ondulata

Teigrädchen, gewellt

Roulette à pâte cannelée

Ruleta cortapasta acanalada

| art.     | Ø cm. | l. cm. |
|----------|-------|--------|
| 18325-02 | 5,5   | 18     |



SS

**Double pastry wheel**

Rotella taglia pasta lama doppia

Teigrädchen, glatt u. gewellt

Roulette à pâte double

Ruleta cortapasta doble

| art.     | Ø cm. | l. cm. |
|----------|-------|--------|
| 18325-03 | 5,5   | 18     |



**Cutting roller, POM**

Rullo tagliapasta, POM

Rollmesser, POM

Rouleau à lamelles, POM

Rodillo, POM

| art.     | cm. |
|----------|-----|
| 47026-06 | 6   |



**Spiked roller, POM**

Rullo bucasfoglia, POM

Stipprolle, POM

Pique-pâte, POM

Rodillo, POM

| art.     | cm.  |
|----------|------|
| 47024-06 | 6,0  |
| 47024-10 | 11,5 |



**Cutting roller, POM**

Rullo per losanghe, POM

Rollmesser, POM

Rouleau à losanges, POM

Rodillo a rombos, POM

| art.     | cm.  |
|----------|------|
| 47025-06 | 6,0  |
| 47025-10 | 11,5 |



SS

**Spiked roller**

Rullo bucasfoglia

Stipprolle

Pique-pâte

Rodillo

| art.     | cm. |
|----------|-----|
| 47028-12 | 12  |



SS

**Cutting roller**

Rullo per losanghe

Rollmesser

Rouleau à losanges

Rodillo a rombos

| art.     | cm. |
|----------|-----|
| 47029-12 | 12  |



PP  
SS

**Croissant cutter**  
Taglia croissants  
Dreieckschneidewalze  
Coupe-croissants  
Cortador para croissants

| art.     | dim. cm. |
|----------|----------|
| 47027-11 | 18x20    |
| 47027-12 | 18x14    |
| 47027-13 | 11x15    |
| 47027-14 | 9,7x21   |
| 47027-15 | 18x20 2x |
| 47027-16 | 18x20 3x |

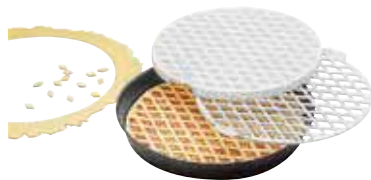

PS

**Stencil for grating pastry**  
Stampo decora crostate  
Gitterstempel  
Empreinte pour grille de pâte  
Molde tortas

| art.     | Ø cm. |
|----------|-------|
| 47030-30 | 30    |

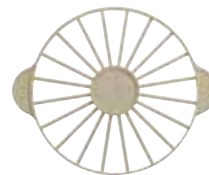

PP

**Cake marker**  
Segnaporzioni  
Tortenteiler  
Diviseur à tarte  
Marcador de tartas

| art.     | Ø cm. | por. |
|----------|-------|------|
| 47032-10 | 26,5  | 10   |
| 47032-20 | 26,5  | 20   |



PP

**Cake marker, double-sided**  
Segnaporzioni, doppio  
Tortenteiler, doppelseitig  
Diviseur à tarte, double  
Marcador de tartas, doble

| art.     | Ø cm. | por.  |
|----------|-------|-------|
| 47033-08 | 18    | 8-12  |
| 47033-12 | 26,5  | 12-18 |
| 47033-14 | 26,5  | 14-18 |



**Rolling pin, non-stick coated**  
Rullo antiaderente  
Rollwalze mit Antihftbeschichtung  
Rouleau avec revêtement anti-adhésif  
Rodillo amasador anti-adherente

| art.     | Ø cm. | l. cm. |
|----------|-------|--------|
| 47035-40 | 5,5   | 20     |
| 47035-48 | 6,5   | 25     |



W

**Rolling pin**  
Rullo  
Rollwalze  
Rouleau  
Rodillo amasador

| art.     | Ø cm. | l. cm. |
|----------|-------|--------|
| 47036-30 | 9     | 30     |
| 47036-35 | 9     | 35     |
| 47036-40 | 9     | 40     |
| 47036-45 | 9     | 45     |
| 47036-50 | 9     | 50     |
| 47036-60 | 9     | 60     |



W

**Rolling pin**  
Rullo  
Rollwalze  
Rouleau  
Rodillo amasador

| art.     | Ø cm. | l. cm. |
|----------|-------|--------|
| 47038-50 | 9     | 50     |
| 47038-60 | 7     | 60     |



PE

**Rolling pin**  
Rullo  
Rollwalze  
Rouleau  
Rodillo amasador

| art.     | Ø cm. | l. cm. |
|----------|-------|--------|
| 47037-30 | 8,0   | 30     |
| 47037-40 | 7,5   | 40     |



PE

**Rolling pin**  
Rullo  
Rollwalze  
Rouleau  
Rodillo amasador

| art.     | Ø cm. | l. cm. |
|----------|-------|--------|
| 47034-23 | 2,5   | 23     |
| 47034-51 | 5,0   | 50     |



W

**Rolling pin**  
Rullo  
Rollwalze  
Rouleau  
Rodillo amasador

| art.     | Ø cm. | l. cm. |
|----------|-------|--------|
| 47034-52 | 5     | 50     |



SS

**Rolling pin**  
Rullo  
Rollwalze  
Rouleau  
Rodillo amasador

| art.     | Ø cm. | l. cm. |
|----------|-------|--------|
| 47034-50 | 5     | 50     |





**PE**

**Rolling dough cutter**

Rullo tagliapasta  
Rollholzer  
Rouleau coupe-bandes  
Rodillo cortador

| art.     | l. cm. | cut mm. |
|----------|--------|---------|
| 47039-05 | 19     | 5       |
| 47039-10 | 19     | 10      |



**PE**

**Rolling dough cutter**

Rullo tagliapasta  
Rollholzer  
Rouleau coupe-bandes  
Rodillo cortador

| art.     | l. cm. | cut mm. |
|----------|--------|---------|
| 47039-15 | 19     | 15      |



**Pastry brush non-stick coated bristles**

Pennello setole antiaderenti  
Pinself, antihafbeschichtete Borsten  
Pinceau poils anti-adhérentes  
Pincel cerdas antiadherentes

| art.     | cm. | U. Pack |
|----------|-----|---------|
| 47640-25 | 2,5 | 1       |
| 47640-35 | 3,5 | 1       |

**Nylon bristles. Heat resistant up to +150°C.**  
Setole nylon. Resistente al calore fino a +150°C.



**Pastry brush**

Pennello per alimenti  
Kuchenpinsel  
Pinceaux à pâtissier  
Pincel de cocina

| art.     | cm. | U. Pack |
|----------|-----|---------|
| 47642-30 | 3   | 6       |
| 47642-40 | 4   | 6       |
| 47642-50 | 5   | 6       |
| 47642-60 | 6   | 6       |
| 47642-70 | 7   | 6       |

**Plastic handle, stainless steel ferrule.**  
Manico plastica, ghiera inox.



**Pastry brush**

Pennello per alimenti  
Kuchenpinsel  
Pinceaux à pâtissier  
Pincel de cocina

| art.     | cm. | U. Pack |
|----------|-----|---------|
| 47643-30 | 3   | 6       |
| 47643-40 | 4   | 6       |
| 47643-50 | 5   | 6       |
| 47643-60 | 6   | 6       |
| 47643-70 | 7   | 6       |

**Plastic handle, stainless steel ferrule.**  
Manico plastica, ghiera inox.



**Pastry brush**

Pennello per alimenti  
Kuchenpinsel  
Pinceaux à pâtissier  
Pincel de cocina

| art.     | Ø cm. | U. Pack |
|----------|-------|---------|
| 47644-15 | 1,5   | 6       |

**Plastic handle and ferrule.**  
Manico e ghiera plastica.



**PA**

**Pastry brush**

Pennello per alimenti  
Kuchenpinsel  
Pinceaux à pâtissier  
Pincel de cocina

| art.     | cm. | U. Pack |
|----------|-----|---------|
| 47645-40 | 4   | 6       |
| 47645-60 | 6   | 6       |
| 47645-75 | 7,5 | 6       |

**Natural bristles. – Setole naturali.**



**PA**

**Pastry brush**

Pennello per alimenti  
Kuchenpinsel  
Pinceaux à pâtissier  
Pincel de cocina

| art.     | cm. | U. Pack |
|----------|-----|---------|
| 47646-40 | 4   | 6       |
| 47646-60 | 6   | 6       |
| 47646-75 | 7,5 | 6       |

**Polyester bristles. – Setole in poliestere.**



**PP**

**Set 10 dough scrapers**

Set 10 raschietti  
Teigschaber, 10 Stk.  
Set 10 raclettes  
Conjunto 10 rasquetas

| art.     | dim. mm. |
|----------|----------|
| 47621-01 | 216x128  |



**PP**

**Set 10 dough scrapers**

Set 10 raschietti  
Teigschaber, 10 Stk.  
Set 10 raclettes  
Conjunto 10 rasquetas

| art.     | dim. mm. |
|----------|----------|
| 47621-02 | 120x86   |



**PP**

**Set 10 dough scrapers**

Set 10 raschietti  
Teigschaber, 10 Stk.  
Set 10 raclettes  
Conjunto 10 rasquetas

| art.     | dim. mm. |
|----------|----------|
| 47621-03 | 120x88   |



**PP**

**Set 10 dough scrapers**

Set 10 raschietti  
Teigschaber, 10 Stk.  
Set 10 raclettes  
Conjunto 10 rasquetas

| art.     | dim. mm. |
|----------|----------|
| 47621-04 | 121x81   |



PP

**Set 10 dough scrapers**

Set 10 raschietti  
Teigschaber, 10 Stk.  
Set 10 raclettes  
Conjunto 10 rasquetas

| art.     | dim. mm. |
|----------|----------|
| 47621-05 | 148x99   |



PP

**Set 10 decorating combs**

Set 10 pettini decoratori  
Dekorationskamm, 10 Stk  
Set 10 peignes à decor  
Conjunto 10 peines decoradores

| art.     | dim. mm. |
|----------|----------|
| 47621-06 | 145x99   |



PP

**Set 10 decorating combs**

Set 10 pettini decoratori  
Dekorationskamm, 10 Stk  
Set 10 peignes à decor  
Conjunto 10 peines decoradores

| art.     | dim. mm. |
|----------|----------|
| 47621-07 | 110x80   |



PP

**Set 10 decorating combs**

Set 10 pettini decoratori  
Dekorationskamm, 10 Stk  
Set 10 peignes à decor  
Conjunto 10 peines decoradores

| art.     | dim. mm. |
|----------|----------|
| 47621-08 | 216x128  |



SS

**Set 3 decorating combs**

Set 3 pettini decoratori  
Dekorationskamm, 3 Stk  
Set 3 peignes à decor  
Conjunto 3 peines decoradores

| art.     | dim. mm. |
|----------|----------|
| 47625-03 | 100x100  |



SS

**Sugar dredger**

Spargi zucchero  
Zuckerstreuer  
Glacière à sucre  
Dosificador para azúcar

| art.     | Ø cm. | h. cm. |
|----------|-------|--------|
| 47022-12 | 7     | 9      |



PP

**Moisture bottle**

Flacone per bagne  
Sprühflasche  
Bouteille à puncher  
Frasco nebulizador

| art.     | dim. cm.    | lt. |
|----------|-------------|-----|
| 47679-10 | 10x5,6x27,5 | 1   |



NEW

PP

**Spraying bottle**

Flacone nebulizzatore  
Sprühflasche  
Bouteille à puncher spray  
Frasco nebulizador

| art.     | dim. cm. | lt. |
|----------|----------|-----|
| 47679-11 | 7x7x30   | 1   |



SS

**Flour sifter**

Setaccio farina  
Einhand-Drücksieb  
Tamiseur farine  
Tamiz para harina

| art.     | Ø cm. | gr. |
|----------|-------|-----|
| 42607-05 | 12    | 500 |



**Icing sugar sieve**

Setaccio per zucchero a velo  
Sieb für Puderzucker  
Tamis à sucre glace  
Cedazo para azúcar glas

| art.     | Ø cm. | h. cm. |
|----------|-------|--------|
| 47614-25 | 25,5  | 7      |



**Sieve for flour**

Setaccio rete farina  
Sieb für Mehl  
Tamis pour farine  
Cedazo para harina

| art.     | Ø cm. | h. cm. |
|----------|-------|--------|
| 47615-25 | 25,5  | 7      |



**Flour brush**

Spazzola per farina  
Mehlbürste  
Brosse à pétrin  
Cepillo para harina

| art.     | cm. |
|----------|-----|
| 42614-21 | 30  |

Horse hair. – Setole di cavallo.



NEW

SS

Vassoio espositore  
Auslegeplatte  
Plat patissier  
Bandeja pastelería

| art.     | dim. cm.  |
|----------|-----------|
| 47074-01 | 30x20x1,5 |
| 47074-02 | 40x10x1,5 |
| 47074-03 | 40x20x1,5 |
| 47074-04 | 40x30x1,5 |

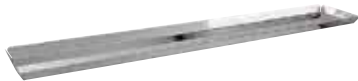

NEW

SS

Vassoio espositore  
Auslegeplatte  
Plat patissier  
Bandeja pastelería

| art.     | dim. cm.  |
|----------|-----------|
| 47074-05 | 50x10x1,5 |
| 47074-06 | 60x6x1,5  |
| 47074-07 | 60x10x1,5 |
| 47074-08 | 60x20x1,5 |



SS

**Display tray**  
Vassoio espositore  
Auslegeplatte  
Plat patissier  
Bandeja pastelería

| art.     | dim. cm. |
|----------|----------|
| 47075-20 | 20x16x1  |
| 47075-30 | 30x21x1  |
| 47075-45 | 45x34x1  |



SS

**Display tray**  
Vassoio espositore  
Auslegeplatte  
Plat patissier  
Bandeja pastelería

| art.     | dim. cm.    |
|----------|-------------|
| 42533-23 | 23x16,5x0,5 |
| 42533-26 | 26x19,5x0,5 |
| 42533-31 | 31x24x0,5   |
| 42533-36 | 36x28,5x0,5 |
| 42533-40 | 40x32,5x0,5 |



**Display tray, aluminum**  
Vassoio espositore, alluminio  
Auslegeplatte, Aluminium  
Plat patissier, alu  
Bandeja pastelería, aluminio

| art.     | dim. cm.    |
|----------|-------------|
| 47070-37 | 37,5x24,5x1 |
| 47070-48 | 48x31x1     |
| 47070-60 | 60x40x1     |



**Baking paper, siliconized**  
Carta da forno siliconata  
Baktrennfolie, silikonisiert  
Feuille de cuisson, siliconée  
Papel de horno siliconado

| art.     | dim. cm. | pcs/pz |
|----------|----------|--------|
| 47682-53 | 53x32,5  | 500    |
| 47682-60 | 60x40    | 500    |

**Artificial parchment, bleached, g/m<sup>2</sup>: 41,0, both sides siliconized, reusable, for all kinds of dough.**  
Pergamena artificiale, sbiancata, g/m<sup>2</sup>: 41,0, siliconata fronte/retro, riutilizzabile, idonea per tutti i tipi di pasta.



**Baking paper, PTFE coated**  
Carta da forno, rivestimento PTFE  
Baktrennfolie, PTFE-beschichtet  
Feuille de cuisson, revêtement PTFE  
Papel de horno anti-adherente

| art.     | dim. cm. | U. Pack |
|----------|----------|---------|
| 47681-60 | 60x40    | 10      |

**Fiberglass tissue coated on both sides, can be used up to 500 times, tear-proof. Carefully dry after use.** – Tessuto fibra di vetro rivestito fronte/retro, resistente alla trazione, antiaderente, riutilizzabile più di 500 volte. Asciugare dopo l'uso.



**Baking sheet, silicone, microperforated**  
Tappeto silicone microforato  
Silikonbackmatte, microperforiert  
Tapis cuisson en silicone, microperforé  
Tapete de cocción silicona, microperforado

| art.     | GN  | dim. cm. |
|----------|-----|----------|
| 47691-53 | 1/1 | 53x32,5  |
| 47691-64 | -   | 60x40    |



**Baking sheet, silicone**  
Tappeto silicone  
Silikonbackmatte  
Tapis cuisson en silicone  
Tapete de cocción silicona

| art.     | GN  | dim. cm. |
|----------|-----|----------|
| 47689-53 | 1/1 | 53x32,5  |
| 47689-60 | -   | 60x40    |

SILPAT – SILPAIN – ROUL’PAT



**SILPAT:** Non-stick sheet ideal for backing brioches and buns as well as any kind of sweet bread backed in sheets. Ideal also for working sugar. **SILPAIN:** Non-stick perforated sheet ideal for baking bread and tarts. **ROUL’PAT:** The silicone coating on both sides prevents the sheet from slipping. Perfect to prepare any type of dough and it also enables to easily prepare macaroon.

SILPAT: Antiaderente ideale per la cottura di tutte le viennoiseries e tutti i tipi di pasticceria da panetteria cotti in teglie. Ideale anche per la lavorazione dello zucchero. SILPAIN: Antiaderente areato ideale per la cottura di pani e la cottura in bianco di fondi per crostate. ROUL’PAT: Con il rivestimento in silicone su entrambi i lati, non scivola sul piano di lavoro. Permette di lavorare ogni tipo di pasta, e con grande facilità anche il croccante.



**SILPAT Silicone baking sheet**

Tappeto silicone  
Silikonbackmatte  
Tapis cuisson en silicone  
Tapete de cocción silicona

| art.     | GN  | dim. cm. |
|----------|-----|----------|
| 47680-40 | -   | 40x30    |
| 47680-53 | 1/1 | 53x32,5  |
| 47680-60 | -   | 60x40    |



**SILPAIN Silicone baking sheet**

Tappeto silicone  
Silikonbackmatte  
Tapis de cuisson en silicone  
Tapete de cocción silicona

| art.     | GN  | dim. cm. |
|----------|-----|----------|
| 47685-53 | 1/1 | 53x32,5  |
| 47685-60 | -   | 60x40    |



**ROUL’PAT Silicone baking sheet**

Tappeto silicone  
Silikonbackmatte  
Tapis de cuisson en silicone  
Tapete de cocción silicona

| art.     | dim. cm. |
|----------|----------|
| 47688-60 | 60x40    |



DEMARLE

**Baking tray, aluminum, silicone coated**

Teglia, alluminio silconato  
Alu-Backblech, Silikonbeschichtet  
Plaque alu, revêtement silicone  
Placa aluminio siliconada

| art.     | GN  | dim. cm. |
|----------|-----|----------|
| 41743D32 | 1/1 | 53x32,5  |
| 41743D53 | -   | 53x65    |
| 41743D60 | -   | 40x60    |



DEMARLE

**Baking tray, perforated aluminum, silicone coated**

Teglia, alluminio silconato, forato  
Alu-Backblech, gelocht, Silikonbeschichtet  
Plaque alu perforée, revêtement silicone  
Placa aluminio perforada siliconada

| art.     | GN  | dim. cm. |
|----------|-----|----------|
| 41753D30 | -   | 30x40    |
| 41753D32 | 1/1 | 53x32,5  |
| 41753D53 | -   | 53x65    |
| 41753D60 | -   | 40x60    |



**Baking beans, ceramic**

Noccioli di cottura, ceramica  
Backkerne, Keramik  
Noyaux de cuisson, céramique  
Núcleos de cocción, cerámica

| art.     | Kg. |
|----------|-----|
| 47011-01 | 1   |



**Acetate sheets**

Acetato in fogli  
Acetat Band-Blätter  
Feuilles en acétate  
Hojas de acetato

| art.     | my | dim. cm. | pcs/pz |
|----------|----|----------|--------|
| 47131-30 | 90 | 30x30    | 50     |
| 47131-60 | 90 | 60x40    | 50     |

**Ribbons and sheets to coat molds, to make and unmold single portions and mignons. Non-stick for food use. Suitable for cooling in blast chiller, freezer and fridge, not suitable for cooking. Extra transparent, super resistant.**



**PVC ribbon**

Nastro PVC  
PVC Band  
Ruban pâtissier en PVC  
Cinta PVC

| art.     | my | h. cm. | mt. |
|----------|----|--------|-----|
| 47130-25 | 90 | 2,5    | 305 |
| 47130-30 | 90 | 3,0    | 305 |
| 47130-35 | 90 | 3,5    | 305 |
| 47130-40 | 90 | 4,0    | 305 |
| 47130-45 | 90 | 4,5    | 305 |
| 47130-50 | 90 | 5,0    | 305 |
| 47130-55 | 90 | 5,5    | 305 |
| 47130-60 | 90 | 6,0    | 305 |

**Nastri e fogli per rivestire stampi, per realizzare e sfornare monoporzioni e mignon. Antiaderenti per uso alimentare. Adatti al raffreddamento in abbattitore, congelatore e frigo, non adatti alla cottura. Extra trasparenti, super resistenti**



SS

**Tart ring**

Anello per torte  
Tortenring  
Cercle à tarte  
Anillo para tartas

| art.     | Ø cm. | h. cm. |
|----------|-------|--------|
| 47533-07 | 7     | 2      |
| 47533-08 | 8     | 2      |
| 47533-09 | 9     | 2      |
| 47533-10 | 10    | 2      |
| 47533-12 | 12    | 2      |
| 47533-14 | 14    | 2      |
| 47533-16 | 16    | 2      |
| 47533-18 | 18    | 2      |
| 47533-20 | 20    | 2      |
| 47533-22 | 22    | 2      |
| 47533-24 | 24    | 2      |
| 47533-26 | 26    | 2      |
| 47533-28 | 28    | 2      |
| 47533-30 | 30    | 2      |
| 47533-32 | 32    | 2      |



SS

**Tart ring**

Anello per torte  
Tortenring  
Cercle à tarte  
Anillo para tartas

| art.     | Ø cm. | h. cm. |
|----------|-------|--------|
| 47530-14 | 14    | 3,5    |
| 47530-16 | 16    | 3,5    |
| 47530-18 | 18    | 3,5    |
| 47530-20 | 20    | 3,5    |
| 47530-22 | 22    | 3,5    |
| 47530-24 | 24    | 3,5    |
| 47530-26 | 26    | 3,5    |
| 47530-28 | 28    | 3,5    |
| 47530-30 | 30    | 3,5    |



SS

**Mousse ring**

Anello per mousse  
Schaumspeisenring  
Cercle à mousse  
Anillo para mousse

| art.     | Ø cm. | h. cm. |
|----------|-------|--------|
| 47532-06 | 6,0   | 4,0    |
| 47532-07 | 7,5   | 4,0    |
| 47532-08 | 8,0   | 4,5    |
| 47532-12 | 12,0  | 4,5    |
| 47532-14 | 14,0  | 4,5    |
| 47532-16 | 16,0  | 4,5    |
| 47532-18 | 18,0  | 4,5    |
| 47532-20 | 20,0  | 4,5    |
| 47532-22 | 22,0  | 4,5    |
| 47532-24 | 24,0  | 4,5    |
| 47532-26 | 26,0  | 4,5    |



SS

**Ice cream cake ring**

Anello per torte gelato  
Eistortenring  
Cercle à vacherin  
Circulo alto

| art.     | Ø cm. | h. cm. |
|----------|-------|--------|
| 47534-07 | 7     | 9      |
| 47534-08 | 9     | 9      |
| 47534-09 | 7     | 11     |
| 47534-10 | 9     | 11     |







SS

**Ice cream cake ring**  
Anello per torte gelato  
Eistortenring  
Cercle à vacherin  
Circulo alto

| art.     | Ø cm. | h. cm. |
|----------|-------|--------|
| 47534-00 | 8     | 6      |
| 47534-01 | 10    | 6      |



SS

**Ice cream cake ring**  
Anello per torte gelato  
Eistortenring  
Cercle à vacherin  
Circulo alto

| art.     | Ø cm. | h. cm. |
|----------|-------|--------|
| 47534-06 | 6     | 6      |
| 47534-16 | 16    | 6      |
| 47534-18 | 18    | 6      |
| 47534-20 | 20    | 6      |
| 47534-22 | 22    | 6      |
| 47534-24 | 24    | 6      |
| 47534-26 | 26    | 6      |
| 47534-28 | 28    | 6      |



SS

**Cake setting ring, flexible**  
Anello regolabile, flessibile  
Tortenring, verstellbar, flexible  
Cercle à tarte réglable, flexible  
Anillo ajustable, flexible

| art.     | Ø cm.   | h. cm. |
|----------|---------|--------|
| 47529-07 | 16,5>32 | 7      |



SS

**Extensible frame**  
Telaio regolabile  
Backrahm, verstellbar  
Bande à tarte réglable  
Marco para tarta, ajustable

| art.     | Ø cm.       | h. cm. |
|----------|-------------|--------|
| 47526-05 | 30x30>57x56 | 5      |



SS

**Extensible frame**  
Telaio regolabile  
Backrahm, verstellbar  
Bande à tarte réglable  
Marco para tarta, ajustable

| art.     | Ø cm.       | h. cm. |
|----------|-------------|--------|
| 47528-05 | 19x28>34x54 | 5      |



SS

**Extensible heart frame**  
Telaio cuore regolabile  
Herz-Backrahm, verstellbar  
Bande à tarte réglable  
Marco para tarta, ajustable

| art.     | Ø cm.     | h. cm. |
|----------|-----------|--------|
| 47542-00 | 14,5>26,5 | 5      |



SS

**Rectangle**  
Rettangolo  
Rechteck  
Rectangle  
Rectangular

| art.     | dim. cm.    |
|----------|-------------|
| 47527-55 | 55x35,5x4,5 |



SS

**Rectangle**  
Rettangolo  
Rechteck  
Rectangle  
Rectangular

| art.     | dim. cm. |
|----------|----------|
| 47546-18 | 18x36x5  |
| 47546-30 | 30x40x5  |
| 47546-40 | 40x60x5  |



SS

**Square**  
Quadrato  
Viereck  
Carré  
Cuadrado

| art.     | dim. cm.  |
|----------|-----------|
| 47548-02 | 10x10x4,5 |
| 47548-03 | 18x18x4,5 |
| 47548-04 | 20x20x4,5 |
| 47548-05 | 22x22x4,5 |



SS

**Rounded square**

Quadrato bombato  
Viereck, konvex  
Carré arrondi  
Cuadrado abombado

| art.     | dim. cm.  |
|----------|-----------|
| 47541-02 | 10x10x4,5 |
| 47541-03 | 18x18x4,5 |
| 47541-04 | 20x20x4,5 |



SS

**Oval**

Ovale  
Ovale  
Oval  
Ovale

| art.     | dim. cm.  |
|----------|-----------|
| 47547-22 | 24,5x20x4 |
| 47547-26 | 30x23x4   |
| 47547-30 | 33x26,5x4 |



SS

**Comma**

Virgola  
Komma  
Virgule  
Coma

| art.     | Ø cm. | h. cm. |
|----------|-------|--------|
| 47544-20 | 20    | 4      |
| 47544-25 | 25    | 4      |
| 47544-30 | 30    | 4      |



SS

**Heart**

Cuore  
Herz  
Coeur  
Corazón

| art.     | Ø cm. | h. cm. |
|----------|-------|--------|
| 47542-18 | 18    | 4      |
| 47542-20 | 20    | 4      |
| 47542-22 | 22    | 4      |
| 47542-24 | 24    | 4      |
| 47542-26 | 26    | 4      |



SS

**Triangle**

Triangolo  
Triangolo  
Dreieck  
Triangle  
Triángulo

| art.     | Ø cm. | h. cm. |
|----------|-------|--------|
| 47540-02 | 12    | 4,5    |
| 47540-03 | 20    | 4,5    |
| 47540-04 | 22    | 4,5    |
| 47540-05 | 24    | 4,5    |



SS

**Triangle**

Triangolo  
Triangolo  
Dreieck  
Triangle  
Triángulo

| art.     | Ø cm. | h. cm. |
|----------|-------|--------|
| 47538-20 | 20    | 4      |
| 47538-23 | 23    | 4      |
| 47538-26 | 26    | 4      |

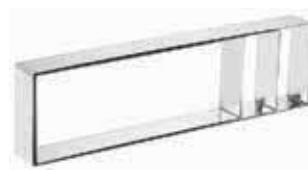

SS

**Rectangle**

Rettangolo  
Rechteck  
Rechteck  
Rectangle  
Rectangular

| art.     | dim. cm. |
|----------|----------|
| 47546-21 | 25x9x2   |
| 47546-22 | 30x9,1x2 |
| 47546-23 | 35x9,2x2 |



SS

**Rectangle**

Rettangolo  
Rechteck  
Rechteck  
Rectangle  
Rectangular

| art.     | dim. cm. |
|----------|----------|
| 47546-41 | 25x9x4   |
| 47546-42 | 30x9,1x4 |
| 47546-43 | 35x9,2x4 |

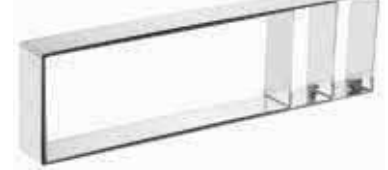

SS

**Rectangle**

Rettangolo  
Rechteck  
Rechteck  
Rectangle  
Rectangular

| art.     | dim. cm. |
|----------|----------|
| 47546-51 | 25x9x5   |
| 47546-52 | 30x9,1x5 |
| 47546-53 | 35x9,2x5 |

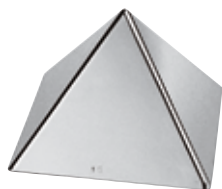

SS

**Pyramid**  
Piramide  
Pyramide  
Pirâmide

| art.     | Ø cm. | h. cm. |
|----------|-------|--------|
| 47535-09 | 9     | 6      |
| 47535-12 | 12    | 8      |
| 47535-15 | 15    | 10     |
| 47535-17 | 17    | 12     |
| 47535-19 | 19    | 13     |



SS

**Half sphere**  
Semi-sfera  
Halbkugel  
Demi-sphère  
Semiesfera

| art.     | Ø cm. | h. cm. |
|----------|-------|--------|
| 47536-12 | 12    | 6      |
| 47536-14 | 14    | 7      |
| 47536-16 | 16    | 8      |
| 47536-18 | 18    | 9      |
| 47536-20 | 20    | 10     |



SS

**Crème caramel**  
Crème caramel  
Crème caramel  
Crème caramel  
Molde para flan

| art.     | Ø cm. | h. cm. | ml. |
|----------|-------|--------|-----|
| 41660-10 | 7     | 5      | 150 |
| 41660-15 | 7     | 6      | 180 |

## MICROPERFORATED CAKE RINGS FASCE MICROFORATE

SS



The micro-holes allow to support the edges of the cake avoiding to collapse during cooking. They also allow to expel the moisture from the dough, obtaining a perfect and always crispy cooking.

I microfori permettono di sostenere i bordi della torta evitandone il collasso in cottura. Consentono inoltre di espellere l'umidità, ottenendo una cottura sempre perfetta e croccante.



**Cake ring, microperforated**  
Fascia microforata  
Tarte-Rahmen perforiert  
Cercle microperforé  
Anillo tarta microperforado

| art.     | Ø cm. | h. cm. |
|----------|-------|--------|
| 47510-07 | 7     | 3,5    |
| 47510-09 | 9     | 3,5    |
| 47510-11 | 11    | 3,5    |
| 47510-13 | 13    | 3,5    |
| 47510-15 | 15    | 3,5    |
| 47510-17 | 17    | 3,5    |
| 47510-19 | 19    | 3,5    |
| 47510-21 | 21    | 3,5    |
| 47510-23 | 23    | 3,5    |
| 47510-25 | 25    | 3,5    |
| 47510-27 | 27    | 3,5    |
| 47510-29 | 29    | 3,5    |
| 47510-31 | 31    | 3,5    |



**Cake ring, microperforated**  
Fascia microforata  
Tarte-Rahmen perforiert  
Cercle microperforé  
Anillo tarta microperforado

| art.     | Ø cm. | h. cm. |
|----------|-------|--------|
| 47511-07 | 7     | 2      |
| 47511-09 | 9     | 2      |
| 47511-11 | 11    | 2      |
| 47511-13 | 13    | 2      |
| 47511-15 | 15    | 2      |
| 47511-17 | 17    | 2      |
| 47511-19 | 19    | 2      |
| 47511-21 | 21    | 2      |
| 47511-23 | 23    | 2      |
| 47511-25 | 25    | 2      |
| 47511-27 | 27    | 2      |
| 47511-29 | 29    | 2      |
| 47511-31 | 31    | 2      |



**Cake ring, microperforated**  
Fascia microforata  
Tarte-Rahmen perforiert  
Cercle microperforé  
Anillo tarta microperforado

| art.     | dim. cm. | h. cm. |
|----------|----------|--------|
| 47512-07 | 7x7      | 3,5    |
| 47512-09 | 9x9      | 3,5    |
| 47512-11 | 11x11    | 3,5    |
| 47512-13 | 13x13    | 3,5    |
| 47512-15 | 15x15    | 3,5    |
| 47512-17 | 17x17    | 3,5    |
| 47512-19 | 19x19    | 3,5    |
| 47512-21 | 21x21    | 3,5    |
| 47512-23 | 23x23    | 3,5    |
| 47512-25 | 25x25    | 3,5    |
| 47512-27 | 27x27    | 3,5    |
| 47512-29 | 29x29    | 3,5    |
| 47512-31 | 31x31    | 3,5    |



**Piepan, aluminum**

Tortiera, alluminio  
Tortenform, Aluminium  
Tourtière, alu  
Molde, aluminio

| art.     | Ø cm. | h. cm. |
|----------|-------|--------|
| 16940-28 | 28    | 5,0    |
| 16940-32 | 32    | 5,5    |
| 16940-36 | 36    | 6,0    |
| 16940-40 | 40    | 6,5    |



**Savarin tin, aluminum**

Ciambella, alluminio  
Savarinform, Aluminium  
Moule à savarin, alu  
Molde para savarin, aluminio

| art.     | Ø cm. | h. cm. | U. Pack |
|----------|-------|--------|---------|
| 47060-06 | 6,0   | 2,5    | 3       |
| 47060-07 | 7,5   | 3,0    | 3       |
| 47060-09 | 9,0   | 3,5    | 3       |
| 47060-10 | 10,0  | 3,5    | 3       |
| 47060-12 | 12,0  | 5,5    | 3       |
| 47060-14 | 14,0  | 5,5    | 3       |
| 47060-16 | 16,0  | 5,5    | 3       |
| 47060-18 | 18,0  | 6,5    | 3       |
| 47060-20 | 20,0  | 6,5    | 3       |
| 47060-22 | 22,0  | 6,5    | 3       |
| 47060-24 | 24,0  | 8,5    | 3       |
| 47060-26 | 26,0  | 8,5    | 3       |
| 47060-30 | 30,0  | 8,5    | 3       |



**Pandoro mold, aluminum**

Stampo pandoro, alluminio  
Pandoro-Form, Aluminium  
Moule à pandoro, aluminium  
Molde pandoro, aluminio

| art.     | gr.  |
|----------|------|
| 47063-01 | 100  |
| 47063-02 | 250  |
| 47063-05 | 500  |
| 47063-07 | 750  |
| 47063-10 | 1000 |



**Gugelhupf, aluminum**

Stampo americano, alluminio  
Gugelhupfform, Aluminium  
Moule à gugelhupf, alu  
Molde gugelhupf, aluminio

| art.     | Ø cm. | h. cm. |
|----------|-------|--------|
| 47062-18 | 18    | 10,5   |
| 47062-20 | 20    | 11,0   |
| 47062-22 | 22    | 12,0   |



**Plumcake, aluminum**

Plumcake, alluminio  
Plumcake, Aluminium  
Plumcake, alu  
Molde para plumcake, aluminio

| art.     | dim. cm. |
|----------|----------|
| 47064-18 | 18x80x6  |
| 47064-22 | 22x90x7  |
| 47064-26 | 26x10x8  |
| 47064-30 | 30x11x9  |



**Beaker shaped tin, aluminum**

Stampo per babà, alluminio  
Timbalform, Aluminium  
Moule à dariole, alu  
Molde, aluminio

| art.     | Ø cm. | h. cm. | U. Pack |
|----------|-------|--------|---------|
| 47066-03 | 3     | 3,5    | 10      |
| 47066-04 | 4     | 4,5    | 10      |
| 47066-05 | 5     | 5,5    | 10      |
| 47066-06 | 6     | 6,0    | 10      |
| 47066-07 | 7     | 7,0    | 10      |
| 47066-08 | 8     | 8,0    | 10      |



**Crème caramel, aluminum**

Crème caramel, alluminio  
Crème caramel, Aluminium  
Crème caramel, alu  
Molde crème caramel, aluminio

| art.     | Ø cm. | h. cm. | U. Pack |
|----------|-------|--------|---------|
| 41659-06 | 6     | 4,8    | 6       |
| 41659-07 | 7     | 5,0    | 6       |
| 41659-08 | 8     | 5,3    | 6       |



**Cassata mold, aluminum**

Stampo cassata, alluminio  
Cassataform, Aluminium  
Moule à cassata, alu  
Molde para cassata, aluminio

| art.     | Ø cm. | h. cm. |
|----------|-------|--------|
| 47068-12 | 12    | 10     |
| 47068-15 | 15    | 12     |



**Zuccotto mold, aluminum**

Stampo per zuccotto, alluminio  
Zuccottoform, Aluminium  
Moule à zuccotto, alu  
Molde para zuccotto, aluminio

| art.     | Ø cm. |
|----------|-------|
| 47069-10 | 10    |
| 47069-12 | 12    |
| 47069-14 | 14    |
| 47069-16 | 16    |
| 47069-18 | 18    |
| 47069-20 | 20    |

# NON STICK CAKE MOLDS TORTIERE ANTIADERENTI

PASTRY  
PASTICCERIA



Wash the mold before the first use. Slightly grease inside surface with oil, butter or margarine before baking. Allow cake to cool down a little before removing from the mold. For the cleaning, hand-wash with dish soap and dry the mold immediately after washing. Use only in traditional ovens (no microwave). Do not use sharp objects or others metal tools which could damage the pan surface. Do not use on a flame or other direct heat source, including stove tops. Do not exceed 230°C. Non-stick coating PFOA free.

Lavare lo stampo prima di utilizzarlo la prima volta. Ungere leggermente l'interno con olio, burro o margarina prima di infornare. Prima di sfornare, lasciare raffreddare per qualche minuto. Lavare a mano con detersivi liquidi ed asciugare lo stampo immediatamente dopo. Utilizzare esclusivamente in forni tradizionali (no microonde). Non utilizzare oggetti appuntiti, polveri abrasive o pagliette metalliche che possano rigare la superficie degli stampi. Evitare il contatto con fonti di calore dirette o fiamma libera. Non superare la temperatura massima di 230°C. Rivestimento antiaderente privo di PFOA.



**Pine mold**

Tortiera pino  
Tannenbaumform  
Tourtière pin  
Molde pino

| art.     | dim. cm.  |
|----------|-----------|
| 47005-24 | 17x24x8,5 |



**Star mold**

Tortiera stella  
Sternform  
Tourtière étoile  
Molde estrella

| art.     | dim. cm.  |
|----------|-----------|
| 47006-25 | 25x25x4,5 |



**Heart pan**

Stampo cuore  
Herz-Backblech  
Plaque coeur  
Molde corazón

| art.     | dim. cm.    |
|----------|-------------|
| 47751-23 | 23x24,5x4,5 |



**Crispy tart pan**

Tortiera forata  
Tortenform, gelocht  
Tourtière perforée  
Molde perforado

| art.     | Ø cm. | h. cm. |
|----------|-------|--------|
| 41729-30 | 30    | 1,3    |
| 41729-34 | 34    | 1,3    |



**Round cake tin**

Tortiera tonda  
Tortenform, rund  
Tourtière ronde  
Molde redondo

| art.     | Ø cm. | h. cm. | U. Pack |
|----------|-------|--------|---------|
| 47739-12 | 12    | 2,1    | 6       |
| 47739-24 | 24    | 2,3    | 1       |
| 47739-28 | 28    | 2,3    | 1       |
| 47739-32 | 32    | 2,5    | 1       |



**Round cake tin**

Tortiera tonda  
Tortenform, rund  
Manqué rond uni  
Molde redondo

| art.     | Ø cm. | h. cm. |
|----------|-------|--------|
| 47710-12 | 12    | 3,0    |
| 47710-16 | 16    | 4,0    |
| 47710-20 | 20    | 4,5    |
| 47710-24 | 24    | 5,0    |
| 47710-28 | 28    | 5,0    |
| 47710-32 | 32    | 5,5    |



**Round mold, fluted edges**

Tortiera festonata  
Runde Obsttortenform  
Tourtière ronde bord cannelé  
Molde rizado

| art.     | Ø cm. | h. cm. |
|----------|-------|--------|
| 47709-20 | 20    | 2,5    |
| 47709-24 | 24    | 2,5    |
| 47709-28 | 28    | 2,5    |
| 47709-32 | 32    | 2,5    |



**Round mold, fluted, loose bottom**

Tortiera festonata, fondo mobile  
Tortenform, gewellter Rand, Heheboden  
Tourtière cannelée, fond amovible  
Molde acanalado, rizado, fondo desmontable

| art.     | Ø cm. | h. cm. |
|----------|-------|--------|
| 47712-20 | 20    | 2,5    |
| 47712-24 | 24    | 2,5    |
| 47712-28 | 28    | 2,5    |
| 47712-32 | 32    | 2,5    |



**Savarin tin**

Ciambella  
Savarinform  
Moule pour savarin  
Molde Savarin

| art.     | Ø cm. | h. cm. | U. Pack |
|----------|-------|--------|---------|
| 47711-08 | 8     | 2,0    | 6       |
| 47711-12 | 12    | 2,5    | 6       |
| 47711-22 | 22    | 4,5    | 1       |
| 47711-24 | 24    | 5,0    | 1       |
| 47711-26 | 26    | 6,2    | 1       |



**Trois Frères cake ring**

Tortiera trois frères  
Frankfurter Kranzform  
Tourtière trois frères

Molde trois frères

| art.     | Ø cm. | h. cm. | U. Pack |
|----------|-------|--------|---------|
| 47713-22 | 22    | 5,5    | 6       |



**Gugelhupf cake pan**

Stampo americano  
Gugelhupfform  
Moule à gugelhupf

Molde gugelhupf

| art.     | Ø cm. | h. cm. |
|----------|-------|--------|
| 47705-22 | 22    | 10     |



**Loaf pan**

Tortiera rettangolare  
Königskuchenform  
Cake embouti

Molde rectangular

| art.     | dim. cm.   |
|----------|------------|
| 47714-26 | 26x9,5x7,5 |
| 47714-28 | 28x10x7,5  |

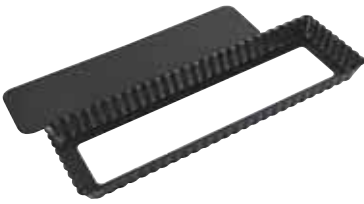

**Rectangular mold, loose plate bottom**

Tortiera, fondo mobile  
Backform, gerippt, Hebeboden  
Tourtière cannelée, fond amovible

Molde fondo desmontable

| art.     | dim. cm.  |
|----------|-----------|
| 47717-35 | 35x11x2,5 |



**Square mold, fluted, loose bottom**

Tortiera festonata, fondo mobile  
Tortenform, gewellter Rand, Hebeboden  
Tourtière carrée, cannelée, fond amovible

Molde cuadrado, rizado, fondo desmontable

| art.     | dim. cm.  |
|----------|-----------|
| 47738-23 | 23x23x2,5 |



**Baking mold Daisy**

Tortiera margherita  
Margeriten-Backform  
Moule à marguerite

Molde margarita

| art.     | Ø cm. | h. cm. |
|----------|-------|--------|
| 47718-20 | 20    | 6      |



**Round mold, fluted, loose bottom**

Tortiera festonata, fondo mobile  
Tortenform, gewellter Rand, Hebeboden  
Tourtière cannelée, fond amovible

Molde acanalado, fondo desmontable

| art.     | Ø cm. | h. cm. | U. Pack |
|----------|-------|--------|---------|
| 47719-10 | 10    | 3      | 6       |
| 47719-24 | 25    | 5      | 1       |



**Round mold, fluted, loose bottom**

Tartelletta festonata, fondo mobile  
Runde, gewellte Tortellets, Hebeboden  
Tartelette ronde cannelée, fond amovible

Molde redondo rizado, fondo desmontable

| art.     | Ø cm. | h. cm. | U. Pack |
|----------|-------|--------|---------|
| 47758-10 | 10    | 1,8    | 6       |
| 47758-12 | 12    | 2,0    | 6       |



**Charlotte mold**

Charlotte  
Charlotte-Form  
Charlotte

Molde Charlotte

| art.     | Ø cm. | h. cm. | U. Pack |
|----------|-------|--------|---------|
| 47734-18 | 18    | 10     | 6       |



**Bavarois mold**

Bavarese  
Bayerische-Kuchenform  
Moule Bavarois

Molde Bávaro

| art.     | Ø cm. | h. cm. |
|----------|-------|--------|
| 47735-18 | 18    | 9      |



**Rectangular cake mold**

Tortiera rettangolare  
Königskuchenform  
Cake évasé

Molde ensanchado

| art.     | dim. cm.   |
|----------|------------|
| 47733-18 | 18x7,5x6,5 |
| 47733-24 | 24x9x7,5   |
| 47733-30 | 30x10x8    |
| 47733-36 | 36x10,5x8  |



**Folding loaf pan**

Tortiera rettangolare apribile  
Aufklappbare-Königskuchenform  
Cake ouvrant

Molde rectangular desmontable

| art.     | dim. cm.  |
|----------|-----------|
| 47715-30 | 30x10x7,5 |





**Rectangular baking sheet**

Teglia rettangolare  
Rechteckige-Backform  
Plaque rectangulaire  
Placa rectangular

art. dim. cm.  
47716-37 37x26x1,3



**Loaf pan with hinges, loose bottom**

Bacinella paté con cerniera, fondo mobile  
Springkastenform, Heheboden  
Pâté à charnière, fond démontable  
Molde con bisagra, fondo desmontable

art. dim. cm.  
47736-30 30x8x8  
47736-35 35x8x8  
47736-40 40x8x8  
47736-50 50x8x8



**Mini paté mold**

Stampo mini-paté  
Pastetenkastenform  
Mini-pâté à croûte  
Molde minipaté

art. dim. cm.  
47018-30 30x4x6  
47018-50 50x4x6



**Loaf pan**

Stampo carré  
Königskuchenform  
Cake évasé  
Molde ensanchado

art. dim. cm.  
47752-09 9x6x3,4  
47752-16 14x6,5x4  
47752-21 17x9,5x5,5



**Fluted loaf pan**

Stampo carré, fondo festonato  
Königskuchenform, gerippt  
Cake évasé, fond cannelé  
Molde ensanchado, fondo rizado

art. dim. cm.  
47753-31 31x12x5



**Baguette baking pan**

Teglia baguettes  
Baguetteform  
Plaque à baguettes  
Placa para baguettes

art. dim. cm.  
47014-35 37,5x33x2,5



**Oval aspic mold**

Aspic ovale  
Ovale Aspikform  
Aspic ovale  
Molde oval

art. dim. cm. U. Pack  
47726-07 7,5x5,5x3,8 6



**Oval aspic mold, star bottom**

Aspic ovale, fondo stella  
Ovale Aspikform, Sternboden  
Aspic ovale, étoilé  
Molde oval, fondo estrella

art. dim. cm. U. Pack  
47727-07 7,5x5,5x3,8 6



**Rum baba mold**

Stampo babà  
Runde Babaform  
Dariole embouti  
Molde para babà

art. Ø cm. h. cm. U. Pack  
47728-06 6 6 6



**Wine leaf tart mold**

Tartelletta foglia di vite  
Törtchenform Weinblatt  
Tartelette feuille vigne  
Molde pasteles

art. Ø mm. h. cm. U. Pack  
47760-12 12 2 6



**Oak leaf tart mold**

Tartelletta foglia di quercia  
Törtchenform Eichenblatt  
Tartelette feuille chêne  
Molde pasteles

art. Ø cm. h. cm. U. Pack  
47759-12 12 2 6





**Savarin mold**

Tartelletta savarin  
Savarin förmchen  
Savarin

Molde savarin

| art.     | Ø mm. | h. cm. | U. Pack |
|----------|-------|--------|---------|
| 47757-65 | 6,5   | 1,5    | 6       |
| 47757-80 | 8,0   | 2,0    | 6       |



**Oval boat mold**

Tartelletta barchetta  
Schiffchen förmchen  
Barquette unie

Molde barquilla

| art.     | dim. cm.   | U. Pack |
|----------|------------|---------|
| 47720-06 | 6x2x1      | 6       |
| 47720-08 | 8x3,3x1,2  | 6       |
| 47720-10 | 10x4,3x1,3 | 6       |
| 47720-12 | 12x5x1,3   | 6       |



**Fluted oval boat mold**

Tartelletta barchetta, festonata  
Schiffchen förmchen, gerippt  
Barquette, cannelée

Molde barquilla, rizado

| art.     | dim. cm.   | U. Pack |
|----------|------------|---------|
| 47721-08 | 8x4x1,2    | 6       |
| 47721-10 | 10x4,5x1,2 | 6       |
| 47721-12 | 12x5x1,4   | 6       |



**Round plain mold**

Tartelletta tonda  
Back förmchen, rund  
Tartelette ronde, unie

Molde redondo

| art.     | Ø cm. | U. Pack |
|----------|-------|---------|
| 47722-05 | 5     | 6       |
| 47722-06 | 6     | 6       |
| 47722-07 | 7     | 6       |
| 47722-08 | 8     | 6       |
| 47722-10 | 10    | 6       |



**Round fluted mold**

Tartelletta tonda festonata  
Back förmchen, rund, gerippt  
Tartelette ronde, cannelée

Molde redondo, rizado

| art.     | Ø cm. | U. Pack |
|----------|-------|---------|
| 47723-05 | 5     | 6       |
| 47723-06 | 6     | 6       |
| 47723-07 | 7     | 6       |
| 47723-08 | 8     | 6       |
| 47723-10 | 10    | 6       |
| 47723-12 | 12    | 6       |



**Brioche mold**

Tartelletta a brioche  
Brioches-Förmchen  
Tartelette brioche

Molde brioche

| art.     | Ø cm. | U. Pack |
|----------|-------|---------|
| 47724-06 | 6     | 6       |
| 47724-08 | 8     | 6       |
| 47724-10 | 10    | 6       |
| 47724-11 | 11    | 6       |



**Friand mold**

Tartelletta rettangolare  
Friand-Förmchen  
Friand

Molde rectangular

| art.     | dim. cm. | U. Pack |
|----------|----------|---------|
| 47725-09 | 10x5x1,4 | 6       |



**Box of small assorted molds**

Scatola tartellette assortite  
Satz Förmchen  
Boîte petits fours, assortis  
Surtido moldes

| art.     | pcs/pz |
|----------|--------|
| 47730-24 | 24     |
| 47730-36 | 36     |
| 47730-60 | 60     |



**Small mold**

Tartelletta  
Törtchenform  
Petit four

Molde pasteles

| art.     | dim. cm. | U. Pack |
|----------|----------|---------|
| 47747-03 | 4,5x3    | 6       |



**Small mold**

Tartelletta  
Törtchenform  
Petit four

Molde pasteles

| art.     | dim. cm. | U. Pack |
|----------|----------|---------|
| 47747-06 | 6x3      | 6       |



**Small mold**

Tartelletta  
Törtchenform  
Petit four

Molde pasteles

| art.     | Ø cm. | h. cm. | U. Pack |
|----------|-------|--------|---------|
| 47747-10 | 4,0   | 1,0    | 6       |
| 47747-11 | 3,5   | 1,4    | 6       |



**Small mold**

Tartelletta  
Törtchenform  
Petit four

Molde pasteles

| art.     | Ø cm. | U. Pack |
|----------|-------|---------|
| 47747-01 | 4,5   | 6       |





**Small mold**  
Tartelletta  
Törtchenform  
Petit four  
Molde pasteles

| art.     | dim. cm. | U. Pack |
|----------|----------|---------|
| 47747-04 | 3,5x3,5  | 6       |



**Small mold**  
Tartelletta  
Törtchenform  
Petit four  
Molde pasteles

| art.     | dim. cm. | U. Pack |
|----------|----------|---------|
| 47747-07 | 6x3      | 6       |



**Small mold**  
Tartelletta  
Törtchenform  
Petit four  
Molde pasteles

| art.     | Ø cm. | U. Pack |
|----------|-------|---------|
| 47723-05 | 5     | 6       |



**Small mold**  
Tartelletta  
Törtchenform  
Petit four  
Molde pasteles

| art.     | dim. cm. | U. Pack |
|----------|----------|---------|
| 47747-05 | 4,5x2,5  | 6       |



**Small mold**  
Tartelletta  
Törtchenform  
Petit four  
Molde pasteles

| art.     | dim. cm. | U. Pack |
|----------|----------|---------|
| 47747-09 | 5x3      | 6       |



**Madeleine sheet**  
Stampo per madeleines  
Madeleine-Backblech  
Plaque madeleines  
Molde Madeleine

| art.     | dim. cm. |
|----------|----------|
| 47731-12 | 26x20    |



**Madeleine sheet**  
Stampo per madeleinettes  
Madeleinettes-Backblech  
Plaque madeleinettes  
Molde Madeleine

| art.     | dim. cm.  |
|----------|-----------|
| 47732-20 | 39,5x12,5 |



**Cup bun pan**  
Stampo tartellette  
Backblech  
Plaque tartelettes  
Molde pasteles

| art.     | Ø cm. | dim. cm.    |
|----------|-------|-------------|
| 47748-35 | 6,5   | 35,5x27x2,5 |



**Snowman mold**  
Stampo pupazzo di neve  
Schneemann-Backblech  
Plaque bonhomme de neige  
Molde muñeco de nieve

| art.     | dim. cm.  |
|----------|-----------|
| 47763-31 | 31x19,7x5 |



**Snowman mold**  
Stampo pupazzo di neve  
Schneemann-Backblech  
Plaque bonhomme de neige  
Molde muñeco de nieve

| art.     | dim. cm. |
|----------|----------|
| 47762-23 | 23x5     |



**Christmas style mold**  
Stampo di Natale  
Weihnachts-Backblech  
Plaque de Noël  
Molde de Noel

| art.     | dim. cm.      |
|----------|---------------|
| 47750-06 | 31,5x21,5x2,5 |



**Santa Claus mold**  
Stampo Babbo Natale  
Weihnachtsmann-Backblech  
Plaque Père Noël  
Molde Papà Noel

| art.     | dim. cm. |
|----------|----------|
| 47761-23 | 23x4,8   |



**Easter muffin pan**  
Stampo motivi pasquali  
Ostern-Backblech  
Plaque Pâque  
Molde Pascua

---

|          |          |
|----------|----------|
| art.     | dim. cm. |
| 47749-35 | 35x27x3  |



**Egg mold**  
Stampo uovo  
Ostereierform  
Moule à oeuf  
Molde para huevos

---

|          |          |
|----------|----------|
| art.     | dim. cm. |
| 47007-26 | 26x8,3   |



**Easter rabbit mold**  
Stampo coniglietto di Pasqua  
Osternhase-Backblech  
Plaque lapin de Pâque  
Molde conejo de Pascua

---

|          |          |
|----------|----------|
| art.     | dim. cm. |
| 47764-12 | 12x2,6   |



**Easter rabbit mold**  
Stampo coniglio di Pasqua  
Osternhase-Backblech  
Plaque lapin de Pâque  
Molde conejo de Pascua

---

|          |          |
|----------|----------|
| art.     | dim. cm. |
| 47764-28 | 28x5,4   |



**Springform mold with 6 bottoms**  
Stampo apribile, 6 fondi  
Springform mit 6 Böden  
Manqué démontable, 6 fonds  
Molde desmontable, 6 fondos

---

|          |       |        |
|----------|-------|--------|
| art.     | Ø cm. | h. cm. |
| 47755-26 | 26    | 6      |



**Springform mold**  
Stampo apribile  
Springform  
Manqué démontable  
Molde desmontable

---

|          |       |        |
|----------|-------|--------|
| art.     | Ø cm. | h. cm. |
| 47754-20 | 20,5  | 6,5    |
| 47754-24 | 24,0  | 6,5    |
| 47754-26 | 26,0  | 6,5    |
| 47754-28 | 28,0  | 6,7    |



**Fluted springform pan**  
Stampo ciambella apribile  
Savarinspringform  
Manqué savarin démontable  
Molde savarin desmontable

---

|          |       |        |
|----------|-------|--------|
| art.     | Ø cm. | h. cm. |
| 47756-20 | 20,5  | 4,7    |
| 47756-24 | 24,0  | 6,8    |
| 47756-26 | 26,0  | 6,5    |
| 47756-28 | 28,0  | 6,7    |

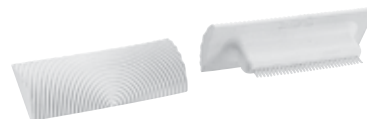

**Rubber comb, wood effect**  
Tampone finto legno  
Kamm aus Kunststoff, holzartig  
Peigne faux bois  
Peine de goma, efecto madera

---

|          |     |
|----------|-----|
| art.     | cm. |
| 47684-15 | 15  |



**Log mold, plastic**  
Stampo per tronco, plastica  
Kastenform, Kunststoff  
Gouttière, plastique  
Molde, plástico

---

|          |          |
|----------|----------|
| art.     | dim. cm. |
| 47659-01 | 48x6,5x7 |
| 47659-02 | 48x6,5x7 |
| 47659-03 | 48x6,5x7 |
| 47659-04 | 48x5,0x4 |

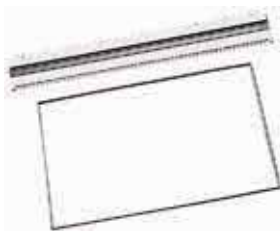

**Comb for Charlotte with frame**  
Pettine Charlotte con telaio  
Charlotte-Kamme mit Rahmen  
Peigne à Charlotte avec cadre  
Peine para Charlotte con marco

---

|          |          |
|----------|----------|
| art.     | dim. cm. |
| 47670-02 | 57x36,5  |

SS



**Comb with 5 rubber blades**  
Pettine con 5 fasce gomma  
Kamm mit 5 Gummiklingen  
Peigne avec 5 bandes à décor  
Peine con 5 láminas de goma

---

|          |          |
|----------|----------|
| art.     | dim. cm. |
| 47672-05 | 70x10    |

SS

**BISCUIT DECORATION FRAMES CM 60X40**  
GRIGLIE DECORO BISCUIT CM 60X40



Place the grill on silicone mat. Spread uniformly the decorating paste. Take off the grid and put into refrigerator. Afterwards spread uniformly the biscuit. Bake in the oven at 230°C for 8 minutes. Place the biscuit upside down on a greaseproof paper and remove carefully the silicone mat. By using an extensible pastry cutter cut the biscuit into stripes.

Appoggiare la griglia su un tappeto di silicone. Spatolare la pasta decoro uniformemente. Togliere la griglia e passare in congelatore. Successivamente stendere il biscuit. Cuocere in forno a 230°C per 8 minuti, appoggiare il biscuit capovolto su un foglio e togliere delicatamente il tappeto. Tagliare le fasce di biscuit nella larghezza desiderata.



S/steel frame - Griglia inox

art.  
47674-01



S/steel frame - Griglia inox

art.  
47674-02



S/steel frame - Griglia inox

art.  
47674-03



S/steel frame - Griglia inox

art.  
47674-04



S/steel frame - Griglia inox

art.  
47674-05



S/steel frame - Griglia inox

art.  
47674-06

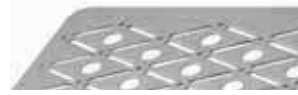

S/steel frame - Griglia inox

art.  
47674-07



S/steel frame - Griglia inox

art.  
47674-08

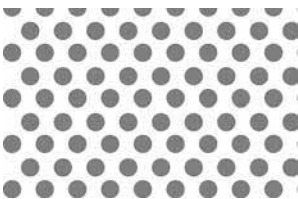

Plastic frame - Griglia plastica

art.      Ø cm.  
47677-01    0,7

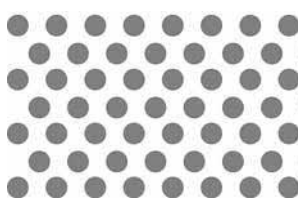

Plastic frame - Griglia plastica

art.      Ø cm.  
47677-02    0,9

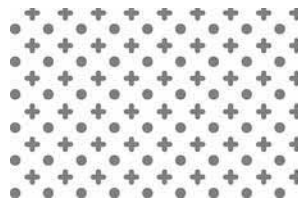

Plastic frame - Griglia plastica

art.  
47677-03

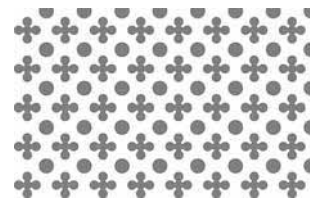

Plastic frame - Griglia plastica

art.  
47677-04

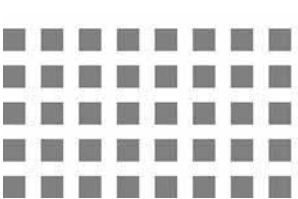

Plastic frame - Griglia plastica

art.  
47677-05

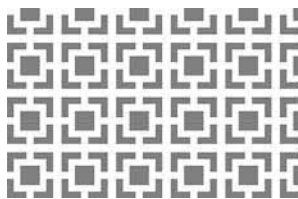

Plastic frame - Griglia plastica

art.  
47677-06

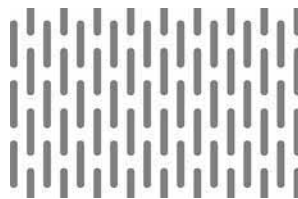

Plastic frame - Griglia plastica

art.  
47677-07



Plastic frame - Griglia plastica

art.  
47677-08

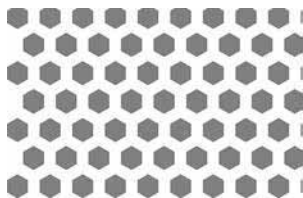

Plastic frame - Griglia plastica

art.  
47677-09

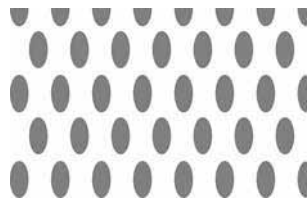

Plastic frame - Griglia plastica

art.  
47677-10

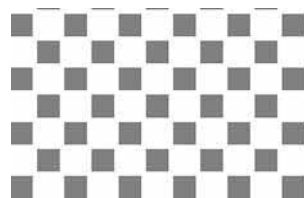

Plastic frame - Griglia plastica

art.  
47677-11



Plastic frame - Griglia plastica

art.  
47677-12

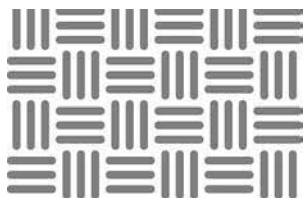

Plastic frame - Griglia plastica

art.  
47677-14



Plastic frame - Griglia plastica

art.  
47677-18

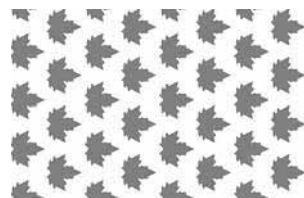

Plastic frame - Griglia plastica

art.  
47677-19

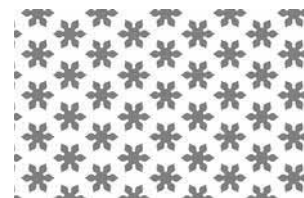

Plastic frame - Griglia plastica

art.  
47677-20



Cookie cutter frame

Placca biscotti  
Ausstechmatte  
Plaque coupe biscuits  
Rejilla corta galletas

| art.     | Ø cm. | dim. cm. | pcs/pz |
|----------|-------|----------|--------|
| 47675-01 | 8,8   | 58x39    | 20     |



Cookie cutter frame

Placca biscotti  
Ausstechmatte  
Plaque coupe biscuits  
Rejilla corta galletas

| art.     | Ø cm. | dim. cm. | pcs/pz |
|----------|-------|----------|--------|
| 47675-02 | 4,5   | 58x39    | 72     |



Cookie cutter frame

Placca biscotti  
Ausstechmatte  
Plaque coupe biscuits  
Rejilla corta galletas

| art.     | Ø cm. | dim. cm. | pcs/pz |
|----------|-------|----------|--------|
| 47675-03 | 5,5   | 58x39    | 53     |

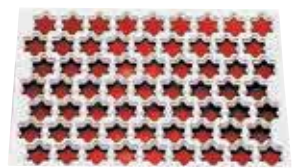

Cookie cutter frame

Placca biscotti  
Ausstechmatte  
Plaque coupe biscuits  
Rejilla corta galletas

| art.     | Ø cm. | dim. cm. | pcs/pz |
|----------|-------|----------|--------|
| 47675-04 | 5,2   | 58x39    | 63     |



Cookie cutter frame

Placca biscotti  
Ausstechmatte  
Plaque coupe biscuits  
Rejilla corta galletas

| art.     | Ø cm. | dim. cm. | pcs/pz |
|----------|-------|----------|--------|
| 47675-05 | 4,5   | 58x39    | 60     |

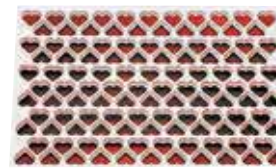

Cookie cutter frame

Placca biscotti  
Ausstechmatte  
Plaque coupe biscuits  
Rejilla corta galletas

| art.     | Ø cm. | dim. cm. | pcs/pz |
|----------|-------|----------|--------|
| 47675-06 | 4     | 58x39    | 95     |

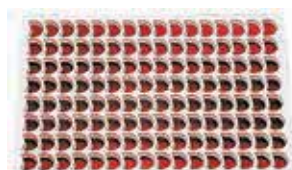

Cookie cutter frame

Placca biscotti  
Ausstechmatte  
Plaque coupe biscuits  
Rejilla corta galletas

| art.     | Ø cm. | dim. cm. | pcs/pz |
|----------|-------|----------|--------|
| 47675-07 | 5     | 58x39    | 78     |



Cookie cutter frame

Placca biscotti  
Ausstechmatte  
Plaque coupe biscuits  
Rejilla corta galletas

| art.     | Ø cm. | dim. cm. | pcs/pz |
|----------|-------|----------|--------|
| 47675-08 | 5     | 58x39    | 68     |



Cookie cutter frame

Placca biscotti  
Ausstechmatte  
Plaque coupe biscuits  
Rejilla corta galletas

| art.     | Ø cm. | dim. cm. | pcs/pz |
|----------|-------|----------|--------|
| 47675-09 | 6-7,5 | 58x39    | 24-26  |



**MONOPORTION TRAY MOLDS**  
**TEGLIE MONOPORZIONI**



**Tray cm. 60x40**

Teglia  
Blech  
Plaque  
Bandeja

| art.     | dim. mm.  | gr. | pcs/pz |
|----------|-----------|-----|--------|
| 47651-01 | Ø 44 h 25 | 20  | 96     |
| 47651-02 | 55x35x25  | 20  | 96     |
| 47651-03 | 46x46x25  | 20  | 96     |
| 47651-04 | 60x38x25  | 20  | 96     |
| 47651-05 | 58x39x25  | 20  | 96     |
| 47651-07 | 38x38x25  | 20  | 96     |



**Extractor**

Estrattore  
Extraktor  
Extrakteur  
Extractor

| art.     | dim. mm.  |
|----------|-----------|
| 47656-01 | Ø 44 h 25 |
| 47656-02 | 55x35x25  |
| 47656-03 | 46x46x25  |
| 47656-04 | 60x38x25  |
| 47656-05 | 58x39x25  |
| 47656-07 | 38x38x25  |



**Cutter**

Tagliapasta  
Ausstechform  
Coupe-pâte  
Cortador

| art.     | dim. mm.  |
|----------|-----------|
| 47655-01 | Ø 44 h 25 |
| 47655-02 | 55x35x25  |
| 47655-03 | 46x46x25  |
| 47655-04 | 60x38x25  |
| 47655-05 | 58x39x25  |
| 47655-07 | 38x38x25  |



**Tray cm. 60x40**

Teglia  
Blech  
Plaque  
Bandeja

| art.     | dim. mm.  | gr. | pcs/pz |
|----------|-----------|-----|--------|
| 47652-01 | Ø 67 h 40 | 75  | 35     |
| 47652-02 | 86x50x40  | 75  | 35     |
| 47652-03 | 74x71x40  | 75  | 35     |
| 47652-04 | 90x58x40  | 75  | 35     |
| 47652-05 | 88x60x40  | 75  | 35     |
| 47652-07 | 59x59x40  | 75  | 35     |



**Extractor**

Estrattore  
Extraktor  
Extrakteur  
Extractor

| art.     | dim. mm.  |
|----------|-----------|
| 47658-01 | Ø 67 h 40 |
| 47658-02 | 86x50x40  |
| 47658-03 | 74x71x40  |
| 47658-04 | 90x58x40  |
| 47658-05 | 88x60x40  |
| 47658-07 | 59x59x40  |



**Cutter**

Tagliapasta  
Ausstechform  
Coupe-pâte  
Cortador

| art.     | dim. mm.  |
|----------|-----------|
| 47657-01 | Ø 67 h 40 |
| 47657-02 | 86x50x40  |
| 47657-03 | 74x71x40  |
| 47657-04 | 90x58x40  |
| 47657-05 | 88x60x40  |
| 47657-07 | 59x59x40  |



Stencil cm. 31x51

| art.     | dim. cm. | pcs/pz |
|----------|----------|--------|
| 47875-11 | 13x3     | 30     |



Stencil cm. 31x51

| art.     | dim. cm. | pcs/pz |
|----------|----------|--------|
| 47875-13 | 7,5x3,5  | 40     |



Stencil cm. 31x51

| art.     | dim. cm. | pcs/pz |
|----------|----------|--------|
| 47875-14 | 6,5x4    | 32     |

PRALINE'S SILICONE MOLDS CM 19X29  
STAMPI IN SILICONE PER PRALINE CM 19X29



Practical, flexible and resistant silicone molds for sweet or salty creations (snaks, truffles, jellies, pralines). Perfect to make large quantities in short time. They withstand from -40° to +250°C. Can be used in the oven, refrigerator and blast chiller.

Pratici stampi in silicone flessibili e resistenti per creazioni dolci o salate (snack, tartufi, gelatine, praline). Ideali per realizzare grandi quantità in poco tempo. Resistono da -40° a +250°C. Utilizzabili in forno, frigorifero e abbattitore.

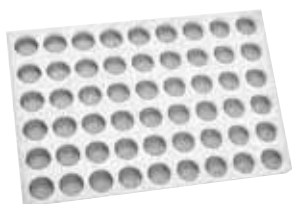

Chocoflex - psc/pz 54

| art.     | Ø mm. | h. |
|----------|-------|----|
| 47783-01 | 26    | 14 |

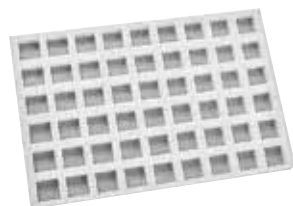

Chocoflex - psc/pz 54

| art.     | dim. mm. |
|----------|----------|
| 47783-02 | 23x23x14 |

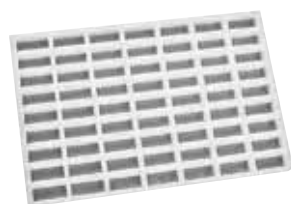

Chocoflex - psc/pz 63

| art.     | dim. mm.   |
|----------|------------|
| 47783-03 | 35x14,5x14 |

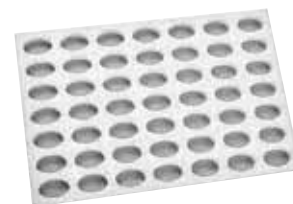

Chocoflex - psc/pz 49

| art.     | dim. mm. |
|----------|----------|
| 47783-04 | 32x21x14 |

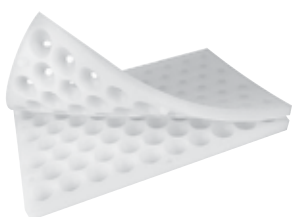

Chocoflex - psc/pz 54

| art.     | Ø mm. | h. |
|----------|-------|----|
| 47783-11 | 26    | 14 |



Chocoflex - psc/pz 40

| art.     | Ø mm. | h. |
|----------|-------|----|
| 47783-12 | 30-10 | 12 |



Chocoflex - psc/pz 15

| art.     | dim. mm. |
|----------|----------|
| 47783-13 | 90x30x19 |



Chocoflex - psc/pz 15

| art.     | dim. mm. |
|----------|----------|
| 47783-14 | 90x30x19 |

**CHOCOLATE  
CIOCCOLATO**

PC



Polycarbonate chocolate molds. Mold size 17,5x27,5 cm.

Stampi policarbonato. Misure stampo 17,5x27,5 cm.



NEW

Chocolate/Ciocolato Praline

| art.     | dim. mm. | pcs/pz |
|----------|----------|--------|
| 47861-02 | 50x25x15 | 21     |



NEW

Chocolate/Ciocolato Praline

| art.     | dim. mm. | pcs/pz |
|----------|----------|--------|
| 47861-03 | 30x30x8  | 24     |



NEW

Chocolate/Ciocolato Praline

| art.     | Ø mm. | h. | pcs/pz |
|----------|-------|----|--------|
| 47861-04 | 35    | 8  | 24     |



NEW

Chocolate/Ciocolato Praline

| art.     | dim. mm. | pcs/pz |
|----------|----------|--------|
| 47861-05 | 33x33x15 | 24     |



NEW

Chocolate/Ciocolato Praline

| art.     | dim. mm.   | pcs/pz |
|----------|------------|--------|
| 47861-07 | 39x18x15,5 | 30     |
| 47861-08 | 96x22x15,5 | 10     |



NEW

Chocolate/Ciocolato Praline

| art.     | dim. mm.   | pcs/pz |
|----------|------------|--------|
| 47861-09 | 39x18x15,5 | 30     |
| 47861-10 | 96x22x17   | 10     |



NEW

Chocolate/Ciocolato Praline

| art.     | dim. mm. | pcs/pz |
|----------|----------|--------|
| 47861-11 | 39x20x16 | 27     |
| 47861-06 | 96x22x17 | 10     |



NEW

Chocolate/Ciocolato Praline

| art.     | dim. mm. | pcs/pz |
|----------|----------|--------|
| 47861-12 | 52x26x14 | 21     |



NEW

Chocolate/Ciocolato Praline

| art.     | dim. mm. | pcs/pz |
|----------|----------|--------|
| 47861-13 | 42x25x6  | 20     |



NEW

Chocolate/Ciocolato Praline

| art.     | dim. mm.  | pcs/pz |
|----------|-----------|--------|
| 47861-14 | 123x27x12 | 8      |



NEW

Chocolate/Ciocolato Praline

| art.     | dim. mm.  | pcs/pz |
|----------|-----------|--------|
| 47861-15 | 138x72x11 | 3      |



Chocolate/Ciocolato Praline

| art.     | dim. mm. | pcs/pz |
|----------|----------|--------|
| 47860-17 | 30x30x12 | 24     |





Chocolate/Ciocolato Praline

| art.     | Ø mm. | h. | pcs/pz |
|----------|-------|----|--------|
| 47860-18 | 27    | 17 | 24     |



Chocolate/Ciocolato Praline

| art.     | Ø mm. | h. | pcs/pz |
|----------|-------|----|--------|
| 47860-21 | 29    | 18 | 24     |



Chocolate/Ciocolato Praline

| art.     | dim. mm. | pcs/pz |
|----------|----------|--------|
| 47860-24 | 40x42x15 | 15     |



Chocolate/Ciocolato Praline

| art.     | dim. mm. | pcs/pz |
|----------|----------|--------|
| 47860-27 | 27x27x13 | 28     |



Chocolate/Ciocolato Praline

| art.     | dim. mm. | pcs/pz |
|----------|----------|--------|
| 47860-31 | 33x25x12 | 24     |



Chocolate/Ciocolato Praline

| art.     | Ø mm. | h. | pcs/pz |
|----------|-------|----|--------|
| 47860-35 | 30    | 19 | 28     |



Chocolate/Ciocolato Praline

| art.     | dim. mm. | h. | pcs/pz |
|----------|----------|----|--------|
| 47860-36 | 25x25x25 | 25 | 40     |



Chocolate/Ciocolato Praline

| art.     | dim. mm. | pcs/pz |
|----------|----------|--------|
| 47860-37 | 36x22x20 | 36     |



Chocolate/Ciocolato Praline

| art.     | dim. mm.   | pcs/pz |
|----------|------------|--------|
| 47860-38 | 48x18,5x19 | 16     |



Chocolate/Ciocolato Praline

| art.     | dim. mm. | pcs/pz |
|----------|----------|--------|
| 47860-39 | 30x18x15 | 30     |



Chocolate/Ciocolato Praline

| art.     | Ø mm. | h. | pcs/pz |
|----------|-------|----|--------|
| 47860-40 | 29    | 21 | 40     |



Chocolate/Ciocolato Praline

| art.     | dim. mm. | pcs/pz |
|----------|----------|--------|
| 47860-42 | 35x23x16 | 36     |



Chocolate/Ciocolato Praline

| art.     | dim. mm. | pcs/pz |
|----------|----------|--------|
| 47860-43 | 38x28x18 | 30     |



Chocolate/Ciocolato Praline

| art.     | dim. mm. | pcs/pz |
|----------|----------|--------|
| 47860-44 | 28x32x15 | 32     |



Chocolate/Ciocolato Praline

| art.     | dim. mm. | pcs/pz |
|----------|----------|--------|
| 47860-46 | 35x20x17 | 30     |



Chocolate/Ciocolato Praline

| art.     | Ø mm. | h. | pcs/pz |
|----------|-------|----|--------|
| 47860-48 | 28    | 24 | 40     |



Chocolate/Ciocolato Praline

| art.     | Ø mm. | h. | pcs/pz |
|----------|-------|----|--------|
| 47860-49 | 30    | 22 | 28     |



Chocolate/Ciocolato Praline

| art.     | Ø mm. | h. | pcs/pz |
|----------|-------|----|--------|
| 47860-50 | 26    | 15 | 35     |





Chocolate/Ciocolato Praline

| art.     | dim. mm. | pcs/pz |
|----------|----------|--------|
| 47860-53 | 22x22x22 | 28     |



Chocolate/Ciocolato Praline

| art.     | dim. mm. | pcs/pz |
|----------|----------|--------|
| 47860-55 | 26x20x21 | 28     |



Chocolate/Ciocolato Praline

| art.     | Ø mm. | h. | pcs/pz |
|----------|-------|----|--------|
| 47860-56 | 24    | 21 | 28     |



Chocolate/Ciocolato Praline

| art.     | dim. mm. | pcs/pz |
|----------|----------|--------|
| 47860-58 | 17x12x5  | 130    |



Chocolate/Ciocolato Praline

| art.     | Ø mm. | h.   | pcs/pz |
|----------|-------|------|--------|
| 47860-60 | 25    | 18,5 | 28     |



Chocolate/Ciocolato Praline

| art.     | dim. mm.   | pcs/pz |
|----------|------------|--------|
| 47860-61 | 30x20x17,5 | 28     |



Chocolate/Ciocolato Praline

| art.     | Ø mm. | h. | pcs/pz |
|----------|-------|----|--------|
| 47860-62 | 27    | 20 | 30     |



Chocolate/Ciocolato Praline

| art.     | Ø mm. | h. | pcs/pz |
|----------|-------|----|--------|
| 47860-63 | 27    | 20 | 30     |



Chocolate/Ciocolato Praline

| art.     | dim. mm. | pcs/pz |
|----------|----------|--------|
| 47860-66 | 25x25x15 | 30     |



Chocolate/Ciocolato Praline

| art.     | dim. mm. | pcs/pz |
|----------|----------|--------|
| 47860-67 | 25x25x15 | 30     |



Chocolate/Ciocolato Praline

| art.     | Ø mm. | h. | pcs/pz |
|----------|-------|----|--------|
| 47860-68 | 28    | 25 | 40     |



Chocolate/Ciocolato Praline

| art.     | dim. mm. | pcs/pz |
|----------|----------|--------|
| 47860-69 | 40x20x18 | 30     |



Chocolate/Ciocolato Praline

| art.     | dim. mm. | pcs/pz |
|----------|----------|--------|
| 47860-70 | 40x18x15 | 30     |



Chocolate/Ciocolato Praline

| art.     | dim. mm. | pcs/pz |
|----------|----------|--------|
| 47860-71 | 26x26x20 | 30     |



Chocolate/Ciocolato Praline

| art.     | dim. mm. | pcs/pz |
|----------|----------|--------|
| 47860-73 | 31x22x22 | 5x6    |



Chocolate/Ciocolato Praline

| art.     | dim. mm. | pcs/pz |
|----------|----------|--------|
| 47860-74 | 32x32x4  | 24     |





Chocolate/Ciocolato Praline

| art.     | dim. mm. | pcs/pz |
|----------|----------|--------|
| 47860-75 | 20x20x16 | 28     |



Chocolate/Ciocolato Praline

| art.     | dim. mm. | pcs/pz |
|----------|----------|--------|
| 47860-81 | 30x18x15 | 30     |



Chocolate/Ciocolato Praline

| art.     | dim. mm. | pcs/pz |
|----------|----------|--------|
| 47860-83 | 30x30x15 | 24     |



Chocolate/Ciocolato Praline

| art.     | Ø mm. | h. | pcs/pz |
|----------|-------|----|--------|
| 47860-84 | 26    | 19 | 35     |



Chocolate/Ciocolato Praline

| art.     | dim. mm. | pcs/pz |
|----------|----------|--------|
| 47860-85 | 35x22x16 | 35     |



Chocolate/Ciocolato Praline

| art.     | dim. mm. | pcs/pz |
|----------|----------|--------|
| 47860-95 | 25x25x13 | 24     |



Chocolate/Ciocolato Praline

| art.     | Ø mm. | h. | pcs/pz |
|----------|-------|----|--------|
| 47860-96 | 35    | 15 | 24     |



Chocolate/Ciocolato Praline

| art.     | dim. mm. | pcs/pz |
|----------|----------|--------|
| 47862-31 | 28x28x16 | 28     |



Chocolate/Ciocolato Praline

| art.     | dim. mm. | pcs/pz |
|----------|----------|--------|
| 47862-32 | 24x24x18 | 28     |



Chocolate/Ciocolato Praline

| art.     | dim. mm. | pcs/pz |
|----------|----------|--------|
| 47862-33 | 40x42x16 | 15     |



Chocolate/Ciocolato Praline

| art.     | dim. mm. | pcs/pz |
|----------|----------|--------|
| 47862-34 | 41x24x20 | 20     |



Chocolate/Ciocolato Praline

| art.     | dim. mm. | pcs/pz |
|----------|----------|--------|
| 47862-35 | 30x30x11 | 28     |



Chocolate/Ciocolato Praline

| art.     | dim. mm. | pcs/pz |
|----------|----------|--------|
| 47862-36 | 35x23x17 | 24     |



Chocolate/Ciocolato Bars

| art.     | dim. mm. | pcs/pz |
|----------|----------|--------|
| 47862-38 | 50x26x3  | 16     |



Chocolate/Ciocolato Bars

| art.     | dim. mm. | pcs/pz |
|----------|----------|--------|
| 47862-39 | 74x33x5  | 12     |



**MINI CHOCO FILL**

PC



Polycarbonate molds mm. 275x175. To create small mignon and refined pralines with an original and inviting look.

Stampi in policarbonato mm. 275x175 . Per creare piccoli mignon e raffinate praline dall'aspetto originale e invitante.



NEW

Mini choco fill

| art.     | Ø mm. | h. | pcs/pz |
|----------|-------|----|--------|
| 47862-64 | 27    | 31 | 28     |



NEW

Mini choco fill

| art.     | Ø mm. | h. | pcs/pz |
|----------|-------|----|--------|
| 47862-65 | 37    | 14 | 15     |



NEW

Mini choco fill

| art.     | dim. mm. | pcs/pz |
|----------|----------|--------|
| 47862-66 | 27x27x31 | 28     |



NEW

Mini choco fill

| art.     | dim. mm. | pcs/pz |
|----------|----------|--------|
| 47862-67 | 33x33x14 | 24     |



Mini choco fill

| art.     | dim. mm. | pcs/pz |
|----------|----------|--------|
| 47862-03 | 32x24x29 | 24     |



Mini choco fill

| art.     | dim. mm. | pcs/pz |
|----------|----------|--------|
| 47862-04 | 44x56x39 | 12     |



Mini choco fill

| art.     | Ø mm. | h. | pcs/pz |
|----------|-------|----|--------|
| 47862-05 | 40    | 17 | 15     |





Mini choco fill

| art.     | dim. mm. | pcs/pz |
|----------|----------|--------|
| 47862-06 | 33x31x20 | 24     |



Mini choco fill

| art.     | dim. mm. | pcs/pz |
|----------|----------|--------|
| 47862-07 | 33x33x23 | 24     |



Mini choco fill

| art.     | dim. mm. | pcs/pz |
|----------|----------|--------|
| 47862-08 | 44x55x23 | 12     |



Mini choco fill

| art.     | Ø mm. | h.   | pcs/pz |
|----------|-------|------|--------|
| 47862-09 | 40    | 18,5 | 15     |



Mini choco fill

| art.     | Ø mm. | h. | pcs/pz |
|----------|-------|----|--------|
| 47862-10 | 32    | 37 | 20     |



Tray/Vassoio

| art.     | dim. cm.  | pcs/pz |
|----------|-----------|--------|
| 47862C10 | 38x10x2,5 | 20     |



Chocolate/Cioccolato Decoration

| art.     | dim. mm. | gr. | pcs/pz |
|----------|----------|-----|--------|
| 47862-70 | 64x26    | 2/3 | 16     |



Chocolate/Cioccolato Decoration

| art.     | dim. mm. | gr. | pcs/pz |
|----------|----------|-----|--------|
| 47862-71 | 47x39    | 2/3 | 15     |



Chocolate/Cioccolato Decoration

| art.     | dim. mm. | gr. | pcs/pz |
|----------|----------|-----|--------|
| 47862-72 | 110x7    | 3/4 | 22     |



Chocolate/Cioccolato Decoration

| art.     | dim. mm. | gr. | pcs/pz |
|----------|----------|-----|--------|
| 47862-73 | 66x21    | 2/3 | 18     |



Chocolate/Cioccolato Decoration

| art.     | dim. mm. | gr. | pcs/pz |
|----------|----------|-----|--------|
| 47862-74 | 65x22    | 2/3 | 18     |



Chocolate/Cioccolato Decoration

| art.     | dim. mm. | gr. | pcs/pz |
|----------|----------|-----|--------|
| 47862-75 | 71x71    | 2/3 | 18     |



Chocolate/Cioccolato Decoration

| art.     | Ø mm. | gr. | pcs/pz |
|----------|-------|-----|--------|
| 47862-76 | 51>73 | 2/3 | 18     |



Chocolate/Cioccolato Decoration

| art.     | dim. mm. | gr. | pcs/pz |
|----------|----------|-----|--------|
| 47862-77 | 68x81    | 2/3 | 18     |





Letters & Numbers

art. h. cm.  
47860-86 3

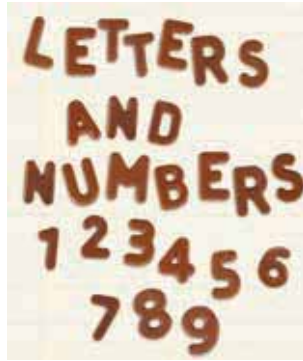

**NEW**

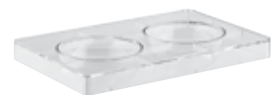

Spheres/Sfere

| art.     | Ø mm. | pcs/pz |
|----------|-------|--------|
| 47861-16 | 20    | 45     |
| 47860-76 | 30    | 24     |

Spheres/Sfere

| art.     | Ø mm. | gr. | pcs/pz |
|----------|-------|-----|--------|
| 47860-77 | 50    | 15  | 8      |

Spheres/Sfere

| art.     | Ø mm. | gr. | pcs/pz |
|----------|-------|-----|--------|
| 47860-78 | 100   | 90  | 2      |

**SILKSCREENED PRALINES MM 275 × 135**  
PRALINE SERIGRAFATE MM 275 × 135

**PC**



Place the silk screen sheet on the base of the mold, cutting it to the right size. Put the sheet with the transfer part facing upwards and close the mold. Fill with chocolate and leave to cool. When cool, open the mold and turn out the chocolates.

Collocare il foglio serigrafato sul fondo dello stampo tagliandolo a misura. Posare il foglio con la parte trasferibile verso l'alto e chiudere lo stampo. Riempire gli stampi e lasciare solidificare il cioccolato. Raffreddati, sformare i cioccolatini.



Magnetic mold pcs 15  
Stampo magnetico gr 13

| art.     | Ø mm. |
|----------|-------|
| 47863-01 | 30    |



Magnetic mold pcs 15  
Stampo magnetico gr 15

| art.     | dim. mm. |
|----------|----------|
| 47863-02 | 33X25    |



Magnetic mold pcs 15  
Stampo magnetico gr 13

| art.     | dim. mm. |
|----------|----------|
| 47863-03 | 27X27    |



Magnetic mold pcs 15  
Stampo magnetico gr 10

| art.     | dim. mm. |
|----------|----------|
| 47863-04 | 27X25    |



PE

**Chocolate bars, set 5 pcs**

Tavolette cioccolato, set 5 pz  
Schokoladentafel, 5 Stk  
Tablettes chocolat, 5 pièces  
Tabletas chocolate, 5 piezas

| art.     | dim. cm. |
|----------|----------|
| 47870-17 | 15x17    |
| 47870-18 | 15x17    |
| 47870-19 | 15x17    |



PC

**Spoon mold**

Stampo cucchiaino  
Löffelform  
Moule à cuillère  
Molde cuchara

| art.     | dim. mm. |
|----------|----------|
| 47860-90 | 25x95    |



PC

**Coffee cup mold**

Stampo tazza caffè  
Kaffeetassenform  
Moule tasse à café  
Molde taza café

| art.     | Ø mm. | h. | pcs/pz |
|----------|-------|----|--------|
| 47860-91 | 51    | 32 | 7      |
| 47860-92 | 59    | 36 | 7      |

Mold/Stampo 17,5x27,5 cm.



PC

**Saucer mold**

Stampo piattino  
Untertassenform  
Moule de soucoupe  
Molde platillo

| art.     | Ø mm. | pcs/pz |
|----------|-------|--------|
| 47860-93 | 80    | 5      |
| 47860-94 | 91    | 3      |

Mold/Stampo 17,5x27,5 cm.





**NEW**

**Egg mold kit**  
Stampo uovo kit  
Ostereierform-Kit  
Moule à oeuf en kit  
Molde para huevo

| art.     | Ø mm. | h.  | gr. | pcs/pz |
|----------|-------|-----|-----|--------|
| 47862-87 | 120   | 185 | 280 | 2      |

**Thermoformed plastic. – Plastica termoformata.**



**NEW**

**Egg mold kit**  
Stampo uovo kit  
Ostereierform-Kit  
Moule à oeuf en kit  
Molde para huevo

| art.     | Ø mm. | h.  | gr. | pcs/pz |
|----------|-------|-----|-----|--------|
| 47862-88 | 115   | 155 | 230 | 2      |

**Thermoformed plastic. – Plastica termoformata.**



**NEW**

**Egg mold kit**  
Stampo uovo kit  
Ostereierform-Kit  
Moule à oeuf en kit  
Molde para huevo

| art.     | Ø mm. | h.  | gr. | pcs/pz |
|----------|-------|-----|-----|--------|
| 47862-89 | 122   | 185 | 270 | 2      |

**Thermoformed plastic. – Plastica termoformata.**



**Half egg mold, strong plastic (PETG)**

Stampo 1/2 uovo, plastica rigida  
Ostereierform 1/2  
Moule à 1/2 oeuf  
Molde para 1/2 huevo

| art.     | dim. cm. | Kg.      |
|----------|----------|----------|
| 47876-11 | 17x25    | 0,5-1,0  |
| 47876-12 | 18x28    | 0,8-1,2  |
| 47876-13 | 34x25    | 1,5-2,0  |
| 47876-14 | 27x40    | 2,0-2,5  |
| 47876-15 | 32x45    | 2,5-3,5  |
| 47876-16 | 36x54    | 4,0-6,0  |
| 47876-17 | 43x64    | 6,0-8,0  |
| 47876-18 | 50x75    | 8,0-10,0 |



**PC**

**Half egg mold**  
Stampo 1/2 uovo  
Ostereierform 1/2  
Moule à 1/2 oeuf  
Molde para 1/2 huevo

| art.     | dim. mm. | gr. | pcs/pz |
|----------|----------|-----|--------|
| 47862-80 | 44x64    | 25  | 10     |
| 47862-81 | 75x105   | 70  | 4      |
| 47862-82 | 90x130   | 150 | 2      |
| 47862-83 | 104x150  | 230 | 2      |
| 47862-84 | 121x175  | 260 | 1      |
| 47862-85 | 141x204  | 380 | 1      |
| 47862-86 | 157x227  | 430 | 1      |



**PE**

**Egg mold**  
Stampo uovo  
Ostereierform  
Moule à oeuf  
Molde para huevos

| art.     | dim. mm.   | pcs/pz |
|----------|------------|--------|
| 47865-44 | 220x160x85 | 1      |
| 47865-23 | 110x80x40  | 2      |
| 47865-80 | 112x83x44  | 2      |
| 47865-81 | 125x94x44  | 2      |
| 47865-82 | 140x100x50 | 2      |
| 47865-83 | 154x110x55 | 2      |



**PE**

**Egg mold**  
Stampo uovo  
Ostereierform  
Moule à oeuf  
Molde para huevos

| art.     | dim. mm. | pcs/pz |
|----------|----------|--------|
| 47865-66 | 80x60x25 | 4      |
| 47865-73 | 40x31x17 | 14     |
| 47865-71 | 36x23x12 | 18     |



**PE**

**Egg mold**  
Stampo uovo  
Ostereierform  
Moule à oeuf  
Molde para huevos

| art.     | dim. mm. | pcs/pz |
|----------|----------|--------|
| 47865-74 | 64x44x26 | 6      |
| 47865-72 | 39x25x13 | 14     |



**PE**

**Egg mold**  
Stampo uovo  
Ostereierform  
Moule à oeuf  
Molde para huevos

| art.     | dim. mm.   | pcs/pz |
|----------|------------|--------|
| 47865-77 | 140x100x49 | 1      |
| 47865-76 | 95x70x40   | 2      |
| 47865-75 | 83x54x24   | 4      |



3D HOLLOW MOLDS/STAMPI 3D CORPO CAVO  
3D-HOHLFORME/MOULES CREUSES 3D/MOLDE 3D

PC



Easter/Pasqua

| art.     | h. mm. |
|----------|--------|
| 47793-11 | 170    |



Easter/Pasqua

| art.     | h. mm. |
|----------|--------|
| 47793-12 | 180    |



Easter/Pasqua

| art.     | h. mm. |
|----------|--------|
| 47793-13 | 140    |



Easter/Pasqua

| art.     | h. mm. | # |
|----------|--------|---|
| 47793-15 | 170    | 2 |



Easter/Pasqua

| art.     | h. mm. |
|----------|--------|
| 47793-16 | 150    |



Easter/Pasqua

| art.     | h. mm. |
|----------|--------|
| 47793-18 | 205    |



Easter/Pasqua

| art.     | h. mm. |
|----------|--------|
| 47793-20 | 160    |



Easter/Pasqua

| art.     | h. mm. | # |
|----------|--------|---|
| 47793-23 | 110    | 3 |



Easter/Pasqua

| art.     | h. mm. |
|----------|--------|
| 47793-26 | 110    |



Christmas/Natale

| art.     | h. mm. | # |
|----------|--------|---|
| 47793-32 | 122    | 3 |



Christmas/Natale

| art.     | h. mm. |
|----------|--------|
| 47793-33 | 180    |



Christmas/Natale

| art.     | h. mm. |
|----------|--------|
| 47793-40 | 168    |



Christmas/Natale

| art.     | h. mm. | # |
|----------|--------|---|
| 47793-43 | 114    | 3 |



Christmas/Natale

| art.     | h. mm. |
|----------|--------|
| 47793-45 | 135    |



Ball/Pallone

| art.     | h. mm. |
|----------|--------|
| 47793-52 | 120    |



Shoe/Scarpa

| art.     | dim. mm.   |
|----------|------------|
| 47793-55 | 220x75x170 |



**FRUITS/TUTTIFRUTTI CM 40X30**

Silicone molds cm 40x30, to create original dessert and surprising monoportions.

Stampi in silicone cm 40x30, per realizzare dessert al piatto e monoporzioni.

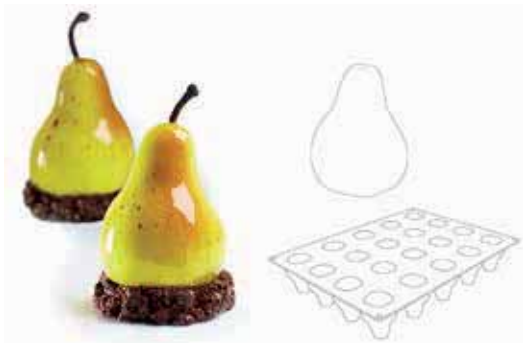

**Pear**  
Pera

| art.     | Ø mm. | h. | ml. | pcs/pz |
|----------|-------|----|-----|--------|
| 47745-06 | 53    | 70 | 90  | 20     |

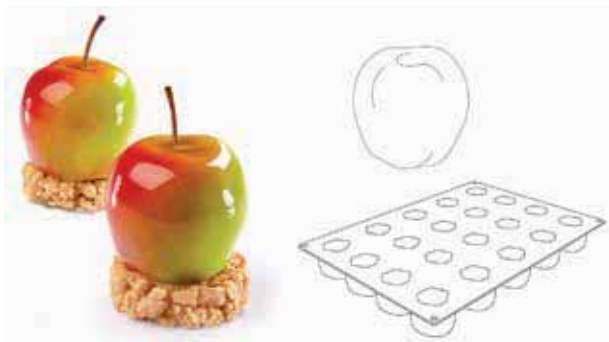

**Apple**  
Mela

| art.     | Ø mm. | h. | ml. | pcs/pz |
|----------|-------|----|-----|--------|
| 47745-07 | 55    | 48 | 90  | 20     |



**Peach/Cherry**  
Pesca/Ciliegia

| art.     | dim. mm. | ml. | pcs/pz |
|----------|----------|-----|--------|
| 47745-08 | 58x53x46 | 90  | 20     |

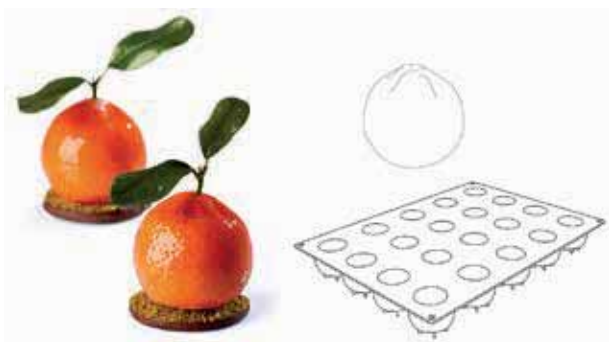

**Tangerine**  
Mandarino

| art.     | Ø mm. | h. | ml. | pcs/pz |
|----------|-------|----|-----|--------|
| 47745-09 | 57    | 50 | 90  | 20     |

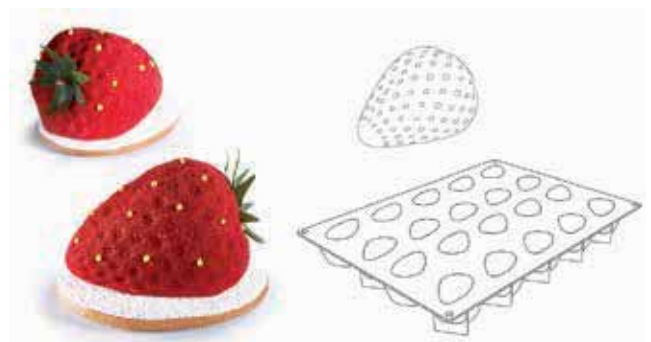

**Strawberry**  
Fragola

| art.     | dim. mm. | ml. | pcs/pz |
|----------|----------|-----|--------|
| 47745-10 | 71x54x46 | 90  | 20     |

SILICONE MOLDS CM 60X40 - CM 40X30  
STAMPI SILICONE CM 60X40 - CM 40X30

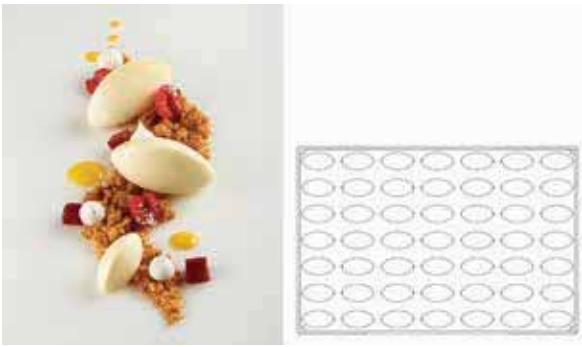

**Quenelle 60x40**

| art.     | dim. mm. | ml. | pcs/pz |
|----------|----------|-----|--------|
| 47746-01 | 66x33x30 | 32  | 49     |



**Mini quenelle 60x40**

| art.     | dim. mm. | ml. | pcs/pz |
|----------|----------|-----|--------|
| 47746-02 | 42x20x20 | 8   | 100    |

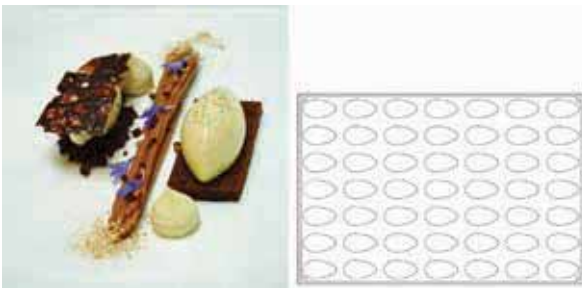

**Quenelle 60x40**

| art.     | dim. mm. | ml. | pcs/pz |
|----------|----------|-----|--------|
| 47746-03 | 66x35x26 | 34  | 49     |



**Mini quenelle 60x40**

| art.     | dim. mm. | ml. | pcs/pz |
|----------|----------|-----|--------|
| 47746-04 | 42x22x17 | 9   | 100    |



**Sphere 40x30**

| art.     | Ø mm. | ml. | pcs/pz |
|----------|-------|-----|--------|
| 47745-02 | 20    | 4   | 48     |



**Sphere 40x30**

| art.     | Ø mm. | ml. | pcs/pz |
|----------|-------|-----|--------|
| 47745-03 | 30    | 14  | 30     |



**Sphere 40x30**

| art.     | Ø mm. | ml. | pcs/pz |
|----------|-------|-----|--------|
| 47745-04 | 40    | 33  | 24     |



**Sphere 40x30**

| art.     | Ø mm. | ml. | pcs/pz |
|----------|-------|-----|--------|
| 47745-05 | 50    | 65  | 20     |



**100% PLATINUM SILICONE CAKE MOLDS, CM 17,5X30 - GN 1/3**  
STAMPI IN SILICONE PLATINICO 100%, CM 17,5X30 - GN 1/3

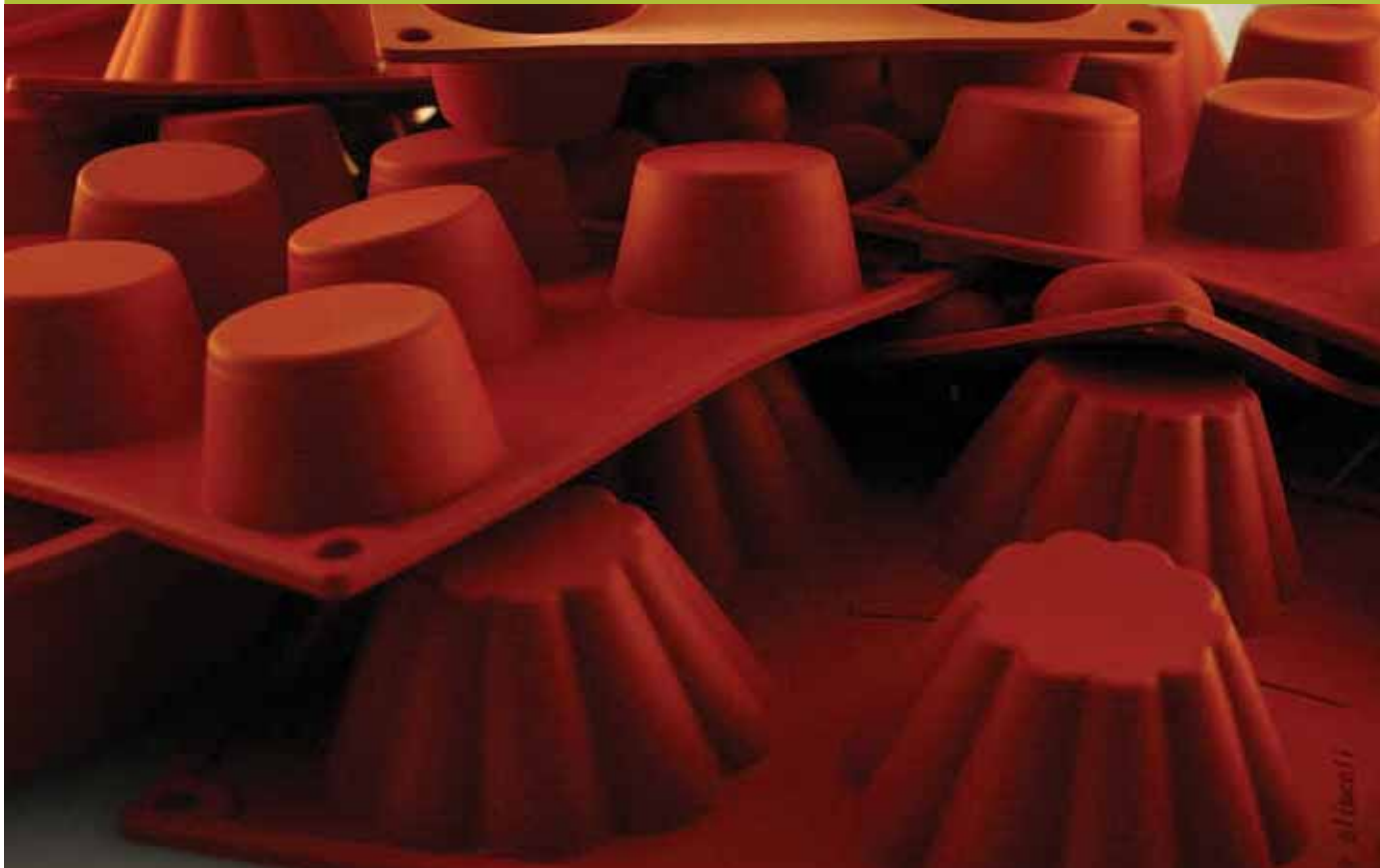

Suitable for freezing and baking (resistance from -40°C up to +280°C). For a correct use, put the moulds on grills or perforated trays, in order to improve the heat diffusion during baking. High non-stick properties to let a perfect demoulding of the product. Can be washed by hand or in dishwasher. Manufactured in conformity with international regulations concerning food contact: D.M. no. 104 of 21/03/1973 (Italian law) - Arrêté du 25/11/1992 (French law) - BGVV (German law) - FDA (USA law).

Adatti per la surgelazione e la cottura (resistono da -40°C a +280°C). Per un utilizzo ottimale, posizionare gli stampi su griglie o teglie forate per favorire la diffusione del calore durante la cottura. Elevata antiaderenza per consentire una perfetta sformatura del prodotto. Lavabili a mano e in lavastoviglie. Conforme alle norme internazionali che regolano l'utilizzo di materiali destinati al contatto con sostanze alimentari: D.M. n. 104 del 21/03/1973 (legislazione italiana) - Arrêté du 25/11/1992 (legislazione francese) - BGVV (legislazione tedesca) - FDA (legislazione statunitense).



**Big baba**  
Babà grande

| art.     | Ø mm. | h. | ml. | pcs/pz |
|----------|-------|----|-----|--------|
| 47742-02 | 55    | 60 | 97  | 8      |



**Medium baba**  
Babà medio

| art.     | Ø mm. | h. | ml. | pcs/pz |
|----------|-------|----|-----|--------|
| 47742-30 | 45    | 48 | 51  | 11     |



**Small baba**  
Babà piccolo

| art.     | Ø mm. | h. | ml. | pcs/pz |
|----------|-------|----|-----|--------|
| 47742-31 | 35    | 38 | 25  | 15     |



**Bavarian**  
Bavarese

| art.     | Ø mm. | h. | ml. | pcs/pz |
|----------|-------|----|-----|--------|
| 47742-41 | 57    | 57 | 110 | 8      |



**Fluted cake**  
Briochette cannellata

| art.     | Ø mm. | h. | ml. | pcs/pz |
|----------|-------|----|-----|--------|
| 47742-12 | 79    | 30 | 109 | 6      |



**Fluted cake**  
Briochette cannellata

| art.     | Ø mm. | h. | ml. | pcs/pz |
|----------|-------|----|-----|--------|
| 47742-27 | 79    | 37 | 100 | 6      |



**Cake**

Cake

| art.     | dim. mm. | ml. | pcs/pz |
|----------|----------|-----|--------|
| 47742-56 | 80x30x30 | 62  | 9      |



**Cannelle**

Cannelle

| art.     | Ø mm. | h. | ml. | pcs/pz |
|----------|-------|----|-----|--------|
| 47742-51 | 56    | 50 | 70  | 8      |



**Cylinder**

Cilindro

| art.     | Ø mm. | h. | ml. | pcs/pz |
|----------|-------|----|-----|--------|
| 47742-17 | 60    | 35 | 89  | 8      |



**Heart**

Cuore

| art.     | dim. mm. | ml. | pcs/pz |
|----------|----------|-----|--------|
| 47742-25 | 65x60x35 | 97  | 8      |



**Biscuit disc**

Disco biscuit

| art.     | Ø mm. | h. | ml. | pcs/pz |
|----------|-------|----|-----|--------|
| 47742-23 | 103   | 20 | 160 | 3      |



**Florentine**

Florentine

| art.     | Ø mm. | h. | ml. | pcs/pz |
|----------|-------|----|-----|--------|
| 47742-19 | 60    | 12 | 27  | 8      |



**Madeleine**

Madeleine

| art.     | dim. mm.   | ml. | pcs/pz |
|----------|------------|-----|--------|
| 47742-21 | 68x45x18   | 30  | 9      |
| 47742-37 | 42x30x11,5 | 8   | 20     |



**Mini cannelle**

Mini cannelle

| art.     | Ø mm. | h. | ml. | pcs/pz |
|----------|-------|----|-----|--------|
| 47742-42 | 35    | 35 | 24  | 18     |



**Mini financier**

Mini finanziere

| art.     | dim. mm. | ml. | pcs/pz |
|----------|----------|-----|--------|
| 47742-14 | 49x26x11 | 11  | 20     |



**Mini Guglhupf**

Mini Guglhupf

| art.     | Ø mm. | h. | ml. | pcs/pz |
|----------|-------|----|-----|--------|
| 47742-34 | 60    | 33 | 70  | 6      |



**Mini muffin**

Mini muffin

| art.     | Ø mm. | h. | ml. | pcs/pz |
|----------|-------|----|-----|--------|
| 47742-20 | 50    | 28 | 43  | 11     |



**Mini oval**

Mini ovale

| art.     | dim. mm. | ml. | pcs/pz |
|----------|----------|-----|--------|
| 47742-09 | 53x33x20 | 28  | 16     |



**Mini pyramid**

Mini piramide

| art.     | dim. mm. | ml. | pcs/pz |
|----------|----------|-----|--------|
| 47742-13 | 36x36x22 | 13  | 15     |





**Mini savarin**

Mini savarin

| art.     | Ø mm. | h. | ml. | pcs/pz |
|----------|-------|----|-----|--------|
| 47742-05 | 41    | 12 | 12  | 18     |



**Muffin**

Muffin

| art.     | Ø mm. | h. | ml. | pcs/pz |
|----------|-------|----|-----|--------|
| 47742-08 | 70    | 40 | 130 | 6      |



**Muffin**

Muffin

| art.     | Ø mm. | h. | ml. | pcs/pz |
|----------|-------|----|-----|--------|
| 47742-33 | 80    | 35 | 110 | 5      |



**Petit four**

Petit four

| art.     | Ø mm. | h. | ml. | pcs/pz |
|----------|-------|----|-----|--------|
| 47742-24 | 40    | 20 | 22  | 15     |



**Pyramid**

Piramide

| art.     | dim. mm. | ml. | pcs/pz |
|----------|----------|-----|--------|
| 47742-07 | 71x71x40 | 92  | 6      |



**Pomponette**

Pomponette

| art.     | Ø mm. | h. | ml. | pcs/pz |
|----------|-------|----|-----|--------|
| 47742-06 | 34    | 16 | 13  | 24     |



**Savarin**

Savarin

| art.     | Ø mm. | h. | ml. | pcs/pz |
|----------|-------|----|-----|--------|
| 47742-15 | 72    | 23 | 67  | 6      |



**Savarin**

Savarin

| art.     | Ø mm. | h. | ml. | pcs/pz |
|----------|-------|----|-----|--------|
| 47742-10 | 65    | 21 | 49  | 8      |



**Half sphere**

Semisfera

| art.     | Ø mm. | h. | ml. | pcs/pz |
|----------|-------|----|-----|--------|
| 47742-04 | 30    | 17 | 8,5 | 24     |



**Half sphere**

Semisfera

| art.     | Ø mm. | h. | ml. | pcs/pz |
|----------|-------|----|-----|--------|
| 47742-03 | 40    | 20 | 17  | 15     |



**Half sphere**

Semisfera

| art.     | Ø mm. | h. | ml. | pcs/pz |
|----------|-------|----|-----|--------|
| 47742-48 | 50    | 23 | 33  | 15     |



**Half sphere**

Semisfera

| art.     | Ø mm. | h. | ml. | pcs/pz |
|----------|-------|----|-----|--------|
| 47742-47 | 60    | 30 | 57  | 8      |



**Half sphere**

Semisfera

| art.     | Ø mm. | h. | ml. | pcs/pz |
|----------|-------|----|-----|--------|
| 47742-01 | 70    | 35 | 89  | 6      |



**Half sphere**

Semisfera

| art.     | Ø mm. | h. | ml. | pcs/pz |
|----------|-------|----|-----|--------|
| 47742-29 | 80    | 40 | 134 | 5      |



**Tartlet**

Tartelletta

| art.     | Ø mm. | h. | ml. | pcs/pz |
|----------|-------|----|-----|--------|
| 47742-16 | 50    | 15 | 20  | 15     |



**Cakes**

Tortine

| art.     | Ø mm. | h. | ml. | pcs/pz |
|----------|-------|----|-----|--------|
| 47742-61 | 80    | 18 | 85  | 6      |



**Round cake tin**

Tortiera tonda

| art.     | Ø mm. | h. | ml.  |
|----------|-------|----|------|
| 47765-24 | 240   | 42 | 1850 |
| 47765-26 | 260   | 45 | 2250 |
| 47765-28 | 280   | 45 | 2600 |



**Fluted round cake tin**

Tortiera tonda cannellata

| art.     | Ø mm. | h. | ml.  |
|----------|-------|----|------|
| 47766-26 | 260   | 30 | 1350 |
| 47766-28 | 280   | 30 | 1600 |
| 47766-30 | 300   | 30 | 1850 |



**Tart tin**  
Crostata

| art.     | Ø mm. | h. | ml.  |
|----------|-------|----|------|
| 47771-28 | 280   | 30 | 1700 |



**Heart cake tin**  
Tortiera cuore

| art.     | dim. mm.   | ml.  |
|----------|------------|------|
| 47770-21 | 220x218x35 | 1150 |



**Plumcake**  
Plumcake

| art.     | dim. mm.   | ml.  |
|----------|------------|------|
| 47773-24 | 240x105x65 | 1385 |
| 47773-28 | 280x105x65 | 1660 |



**Rectangulat cake pan**  
Tortiera rettangolare

| art.     | dim. mm.   | ml.  |
|----------|------------|------|
| 47769-28 | 280x240x40 | 2670 |

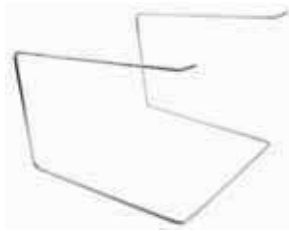

**Drainer**  
Sgocciolatore

| art.     | dim. cm.   |
|----------|------------|
| 47742-00 | 30x30x17,5 |

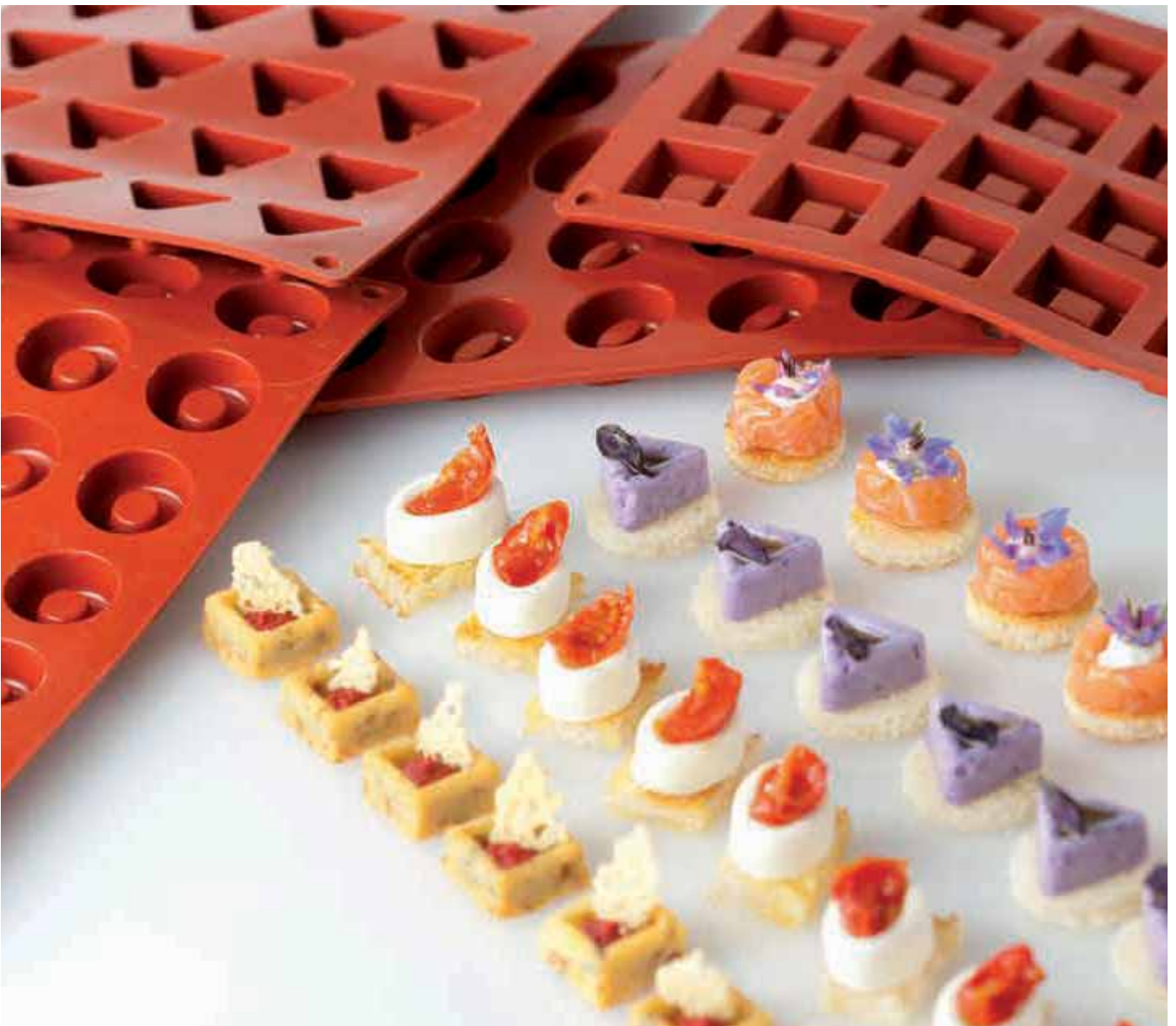
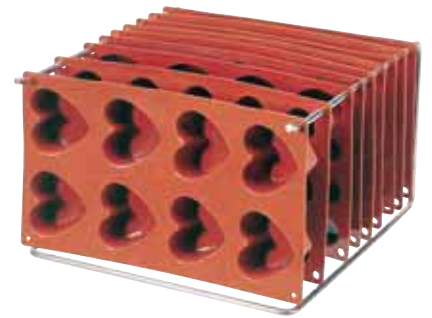

# FLEXIPAN



PASTRY  
PASTICCERIA



The Sasa Demarle Group is the only company in the world to formulate and produce its own food silicone, specially designed for the bakery and pastry industry. The use of this silicone allows an optimal heat distribution, which offers an even baking and colour, as well as perfect non-stick properties for an easy and perfect demoulding. The Flexipan moulds offer great performances with high lifetime expectancy: from 3,000 to 5,000+ baking cycles, depending on the conditions of use. Can be used for cooking and freezing (from -40°C to +240°C), for sweet and/or savory recipes. Can be easily cleaned with water.

Il gruppo Sasa Demarle è l'unica azienda al mondo a formulare e produrre il proprio silicone alimentare, appositamente progettato per l'industria della panificazione e della pasticceria. L'uso di questo silicone consente una distribuzione ottimale del calore, offrendo una cottura e un colore uniformi, nonché proprietà antiaderenti perfette per una facile e perfetta sfornatura. Gli stampi Flexipan offrono grandi prestazioni con un'elevata aspettativa di durata: da 3.000 a 5.000+ cicli di cottura, a seconda delle condizioni di utilizzo. Può essere utilizzato per cucinare e congelare (da -40°C a +240°C), per ricette dolci e/o salate. Si pulisce facilmente con acqua.





**Annapurna**

Pcs/pz 5 - ml. 370

art. mm.

47740137 495x40x33

With s/s frame. – Con supporto inox.



**Bavarois**

Pcs/pz 18 - ml. 100

art. Ø mm. h.

47740105 78 35



**Butterfly**

Pcs/pz 24 - ml. 60

art. mm.

47740141 70x60x20



**Caterpillar**

Pcs/pz 5 - ml. 450

art. mm.

47740138 495x40x36

With s/s frame. – Con supporto inox.



**Champagne biscuits**

Pcs/pz 45 - ml. 20

art. mm.

47740-29 109x24x10



**Charlotte**

Pcs/pz 24 - ml. 60

art. Ø mm. h.

47740-80 62 35



**Charlotte**

Pcs/pz 18 - ml. 100

art. Ø mm. h.

47740-23 78 40



**Chocolate bars**

Pcs/pz 18 - ml. 100

art. mm.

47740128 78x58x40

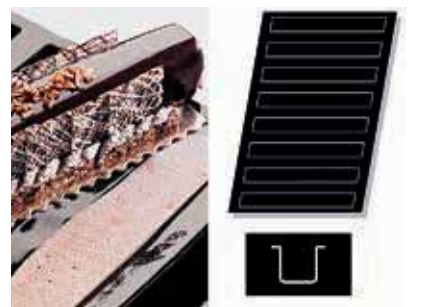

**Christmas log**

Pcs/pz 8 - ml. 450

art. mm.

47740-28 339x40x39



**Christmas log**

Pcs/pz 24 - ml. 80

art. mm.

47740-26 95x40x30



**Christmas log**

Pcs/pz 24 - ml. 115

art. mm.

47740-27 122x42x32



**Christmas log insert**

Pcs/pz 5 - ml. 700

art. mm.

47740-93 495x40x39

With s/s frame. – Con supporto inox.



**Christmas tree**

Pcs/pz 20 - ml. 100

art. mm.

47740119 90x85x30



**Cylinders**

Pcs/pz 24 - ø 63 mm.

art. h. mm. ml.

47740-52 25 65

47740-06 35 90



**Cylinders**

Pcs/pz 15

art. Ø mm. h. ml.

47740-69 82 50 220

47740-70 91 35 190



**Cone insert**

Pcs/pz 40 - ml. 24

art. Ø mm. h.

47740102 50 40



**Cones**

Pcs/pz 20 - ml. 80

art. Ø mm. h.

47740103 70 60



**Cookies**

art. Ø mm. h. ml. pcs

47740-18 59 13 30 40

47740-60 78 10 50 24



**Cookies**

Pcs/pz 12

art. Ø mm. h. ml.

47740-74 100 35 245

47740-75 105 40 305



**Florentins XL**

Pcs/pz 15 - ml. 60

art. Ø mm. h.

47740-61 91/87 8



**Eggs**

Pcs/pz 25 - ml. 95

art. mm.

47740135 94x60x31



**Exagon**

Pcs/pz 60 - ml. 12

art. mm.

47740-83 45x40x12

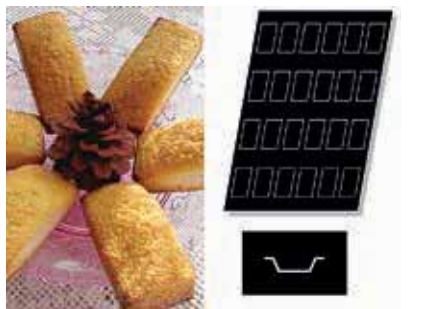

**Financiers**

Pcs/pz 24 - ml. 45

art. mm.

47740-10 86x46x14

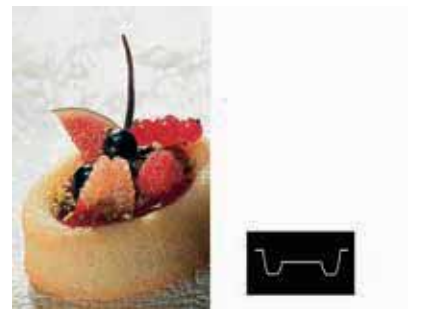

**Flan bases**

Pcs/pz 24 - ml. 70

art. Ø mm. h.

47740-43 80 20

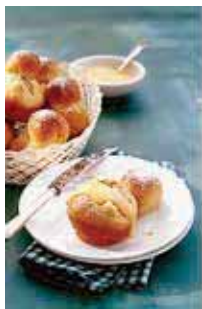

**Fluted brioches**

Pcs/pz 24 - ml. 60

art. mm.  
47740-57 62x49x26



**Fluted brioches**

Pcs/pz 24

| art.     | Ø mm. | h. | ml. |
|----------|-------|----|-----|
| 47740-58 | 68    | 25 | 60  |
| 47740-59 | 78    | 30 | 105 |
| 47740-16 | 81    | 37 | 105 |



**Fluted cakes**

Pcs/pz 16 - ml. 105

art. mm.  
47740-95 110x60x25



**Fluted ingots**

Pcs/pz 24 - ml. 90

art. mm.  
47740127 106x46x25



**Fluted tartlets**

Pcs/pz 24 - ml. 70

art. mm.  
47740132 78x78x20



**Half cylinder**

Pcs/pz 48 - ml. 20

art. mm.  
47740125 85x17x15



**Half egg**

Pcs/pz 56 - ml. 20

art. mm.  
47740140 55x35x20



**Half sphere**

Pcs/pz 48 - ml. 20

art. Ø mm. h.  
47740-02 42 21



**Half sphere**

Pcs/pz 24 - ml. 125

art. Ø mm. h.  
47740-38 80 40



**Half sphere**

Pcs/pz 28 - ml. 50

art. Ø mm. h.  
47740-37 58 31



**Half sphere**

Pcs/pz 24 - ml. 105

art. Ø mm. h.  
47740-03 70 40



**Hearts**

Pcs/pz 81 - ml. 20

art. mm.  
47740-89 75x65x35



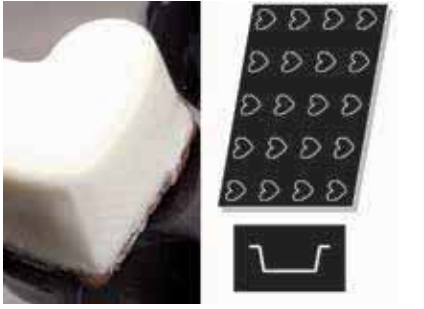

**Hearts**

Pcs/pz 20 - ml. 90

art. mm.

47740-41 66x62x35



**Hexagons**

Pcs/pz 20 - ml. 90

art. Ø mm. h.

47740130 80 25

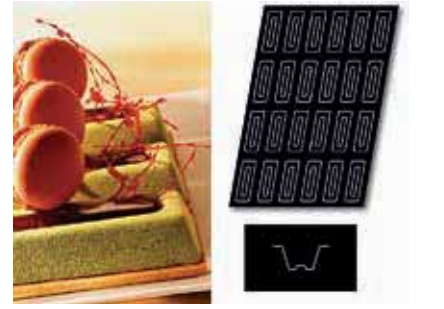

**Hollow ingot**

Pcs/pz 24

art. mm. ml.

47740123 100x40x25 70

47740124 120x40x25 90



**Ingot**

Pcs/pz 24 - ml. 100

art. mm.

47740122 120x40x25

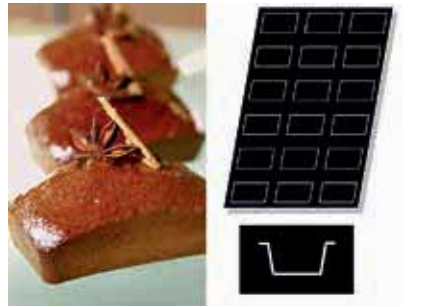

**Ingot**

Pcs/pz 18 - ml. 139

art. mm.

47740-94 102x58x30



**Interlacing hearts**

Pcs/pz 8 - ml. 200

art. mm.

47740101 120x113x35



**Landscapes**

Pcs/pz 27 - ml. 80

art. Ø mm. h.

47740144 75 24



**Little cushion**

Pcs/pz 24 - ml. 70

art. mm.

47740-77 71x57x23

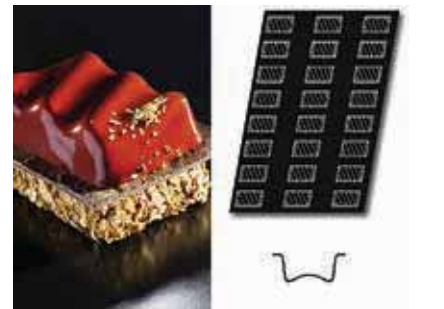

**Little waves**

Pcs/pz 24 - ml. 76

art. mm.

47740121 79x49x25

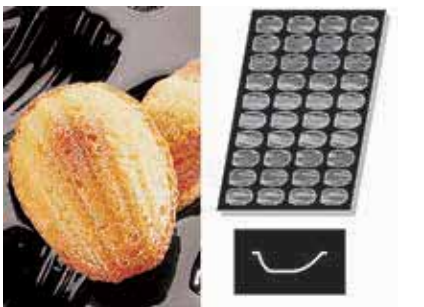

**Madeines**

Pcs/pz 40 - ml. 35

art. mm.

47740-17 78x47x19



**Medallions**

Pcs/pz 54 - ml. 14

art. Ø mm. h.

47740-50 38 10



**Medallions**

Pcs/pz 96 - ml. 5

art. Ø mm. h.

47740-97 28 8



**Mini Charlotte**

Pcs/pz 60 - ml. 9

| art.     | Ø mm. | h. |
|----------|-------|----|
| 47740-82 | 35    | 15 |

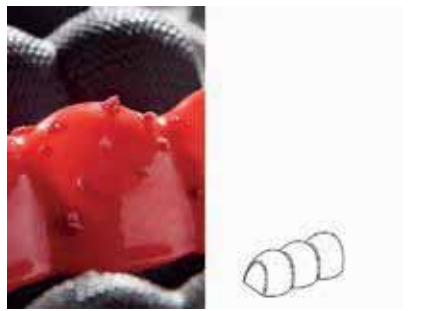

**Mini chenilles**

Pcs/pz 27 - ml. 90

| art.     | mm.       |
|----------|-----------|
| 47740143 | 102x40x36 |



**Mini drops**

Pcs/pz 56 - ml. 18

| art.     | mm.      |
|----------|----------|
| 47740133 | 52x32x20 |



**Mini écrins**

Pcs/pz 24 - ml. 65

| art.     | mm.      |
|----------|----------|
| 47740142 | 50x50x29 |

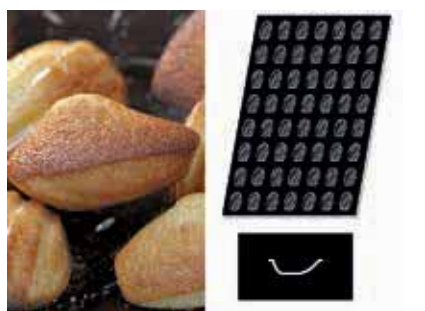

**Mini Madeleines**

Pcs/pz 56 - ml. 15

| art.     | mm.      |
|----------|----------|
| 47740106 | 52x33x15 |



**Mini St Honoré crown**

Pcs/pz 18 - ml. 70

| art.     | Ø mm. | h. |
|----------|-------|----|
| 47740131 | 80    | 20 |



**Muffins**

Pcs/pz 24

| art.     | Ø mm. | h. | ml. |
|----------|-------|----|-----|
| 47740-19 | 73    | 40 | 125 |
| 47740-68 | 79    | 36 | 115 |



**Optagon**

Pcs/pz 40 - ml. 28

| art.     | mm.      |
|----------|----------|
| 47740-34 | 43x40x26 |



**Oval savorins**

Pcs/pz 12 - ml. 230

| art.     | mm.       |
|----------|-----------|
| 47740-81 | 100x80x45 |

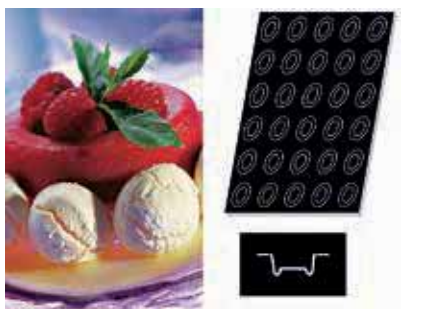

**Oval savorins**

Pcs/pz 30 - ml. 48

| art.     | mm.      |
|----------|----------|
| 47740111 | 70x50x22 |



**Oval savorins**

Pcs/pz 24 - ml. 70

| art.     | mm.      |
|----------|----------|
| 47740-44 | 80x60x25 |



**Oval tartlets**

Pcs/pz 30 - ml. 35

| art.     | mm.       |
|----------|-----------|
| 47740-32 | 106x45x15 |



**Ovals**

Pcs/pz 24 - ml. 80

art. mm.

47740-49 96x45x28

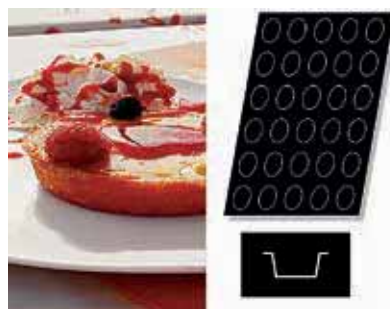

**Ovals**

Pcs/pz 30

art. mm. ml.

47740-46 70x50x25 55

47740-47 70x50x30 75



**Ovals**

Pcs/pz 20 - ml. 100

art. mm.

47740-48 85x60x30

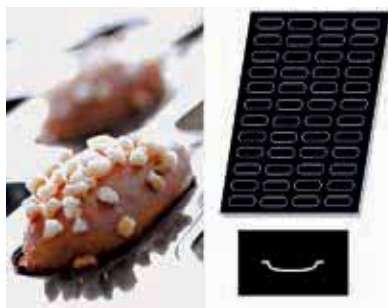

**Ovals**

Pcs/pz 48 - ml. 15

art. mm.

47740-92 70x30x10



**Ovals**

Pcs/pz 24 - ml. 80

art. mm.

47740-55 130x48x18



**Pomponnettes**

Pcs/pz 96 - ml. 14

art. Ø mm. h.

47740-04 36 17

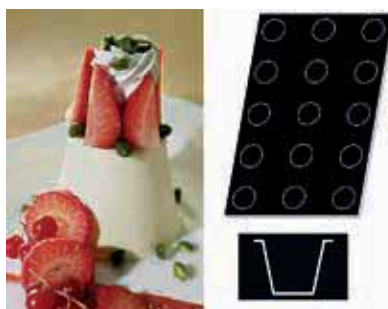

**Puddings**

Pcs/pz 15 - ml. 128

art. Ø mm. h.

47740104 65 55

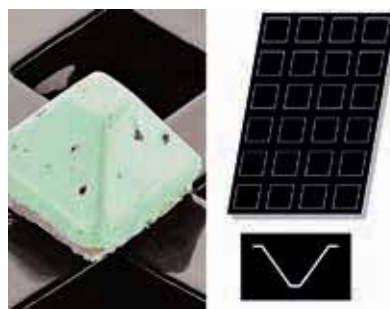

**Pyramids**

Pcs/pz 24 - ml. 90

art. mm.

47740-13 71x71x41

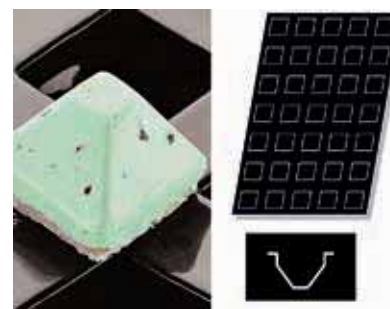

**Pyramids flat bottom**

Pcs/pz 35 - ml. 50

art. mm.

47740-39 50x50x35

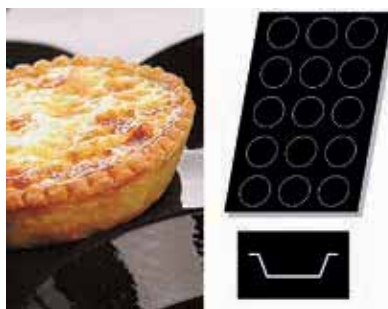

**Quiches**

Pcs/pz 15 - ml. 135

art. Ø mm. h.

47740-85 96 25



**Quiches**

Pcs/pz 24 - ml. 65

art. Ø mm. h.

47740-30 77 20



**Quiches**

Pcs/pz 42 - ml. 30

art. mm.

47740-45 60x40x25

**PASTRY PASTICCERIA  
FLEXIPAN SILICONE 60X40 CM**



**Quiches**

Pcs/pz 15 - ml. 140

| art.     | Ø mm. | h. |
|----------|-------|----|
| 47740-62 | 102   | 20 |



**Quiches**

Pcs/pz 6

| art.     | Ø mm. | h. | ml. |
|----------|-------|----|-----|
| 47740-64 | 147   | 12 | 200 |
| 47740-65 | 150   | 15 | 250 |
| 47740-66 | 166   | 12 | 250 |



**Quiches**

Pcs/pz 6

| art.     | Ø mm. | h. | ml. |
|----------|-------|----|-----|
| 47740-71 | 140   | 25 | 360 |
| 47740-72 | 150   | 24 | 390 |
| 47740-05 | 186   | 12 | 300 |



**Rectangular cakes**

Pcs/pz 24 - ml. 55

| art.     | mm.      |
|----------|----------|
| 47740-25 | 80x30x30 |



**Rectangular cakes**

Pcs/pz 25 - ml. 110

| art.     | mm.      |
|----------|----------|
| 47740-24 | 89x46x25 |



**Rhombus**

Pcs/pz 70 - ml. 9

| art.     | mm.      |
|----------|----------|
| 47740-36 | 60x35x10 |



**Round**

Pcs/pz 11 - ml. 75

| art.     | Ø mm. | h. |
|----------|-------|----|
| 47740-63 | 125   | 16 |



**Round brioche**

Pcs/pz 24 - ml. 65

| art.     | Ø mm. | h. |
|----------|-------|----|
| 47740-56 | 79    | 15 |



**Savarin zaphire**

Pcs/pz 24 - ml. 80

| art.     | mm.      |
|----------|----------|
| 47740114 | 70x70x32 |



**Savarins**

Pcs/pz 35 - ml. 50

| art.     | Ø mm. | h. |
|----------|-------|----|
| 47740-20 | 66    | 20 |



**Savarins**

Pcs/pz 24 - ml. 65

| art.     | Ø mm. | h. |
|----------|-------|----|
| 47740-15 | 70    | 23 |



**Scoop out**

Pcs/pz 24 - ml. 90

| art.     | mm.      |
|----------|----------|
| 47740145 | 85x61x30 |



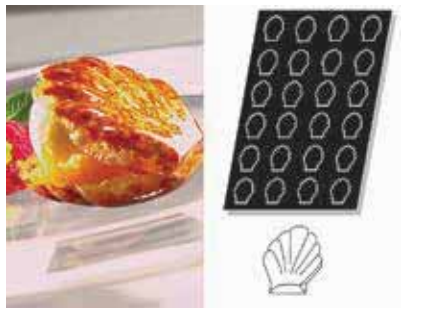

**Shells**

Pcs/pz 24 - ml. 70

art. mm.

47740-79 80x75x20

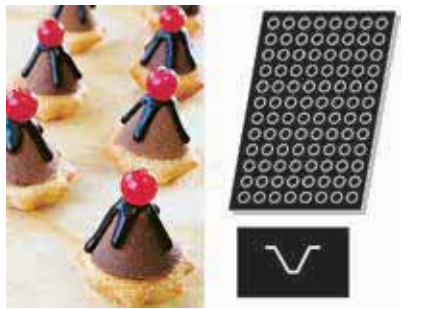

**Small cones**

Pcs/pz 96 - ml. 6

art. Ø mm. h.

47740-99 30 20

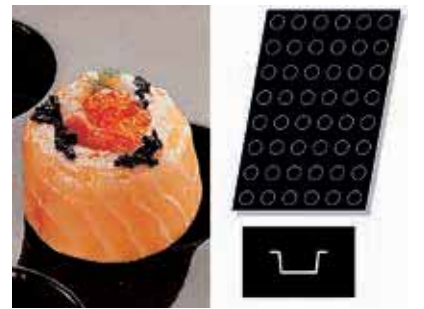

**Small cylinders**

Pcs/pz 48 - ml. 25

art. Ø mm. h.

47740-51 40 20



**Small financiers**

Pcs/pz 84 - ml. 10

art. mm.

47740-09 50x26x11

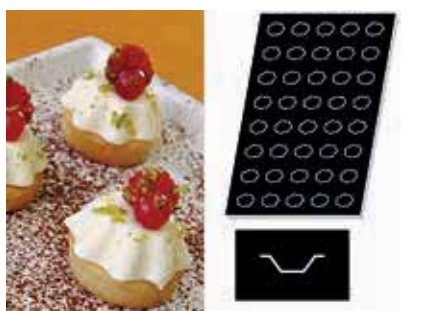

**Small fluted tartlet**

Pcs/pz 40 - ml. 11

art. mm.

47740100 46x38x15



**Small half sphere**

Pcs/pz 96 - ml. 6

art. Ø mm. h.

47740-87 26 16



**Small half sphere**

Pcs/pz 70 - ml. 10

art. Ø mm. h.

47740-01 29 18



**Small hearts**

Pcs/pz 70 - ml. 15

art. mm.

47740115 41x38x16



**Small muffins**

Pcs/pz 40 - ml. 45

art. Ø mm. h.

47740-67 51 29



**Small oval savarin**

Pcs/pz 60 - ml. 9

art. mm.

47740-98 40x30x12



**Small oval tartlets**

Pcs/pz 48 - ml. 10

art. mm.

47740-31 66x27x11

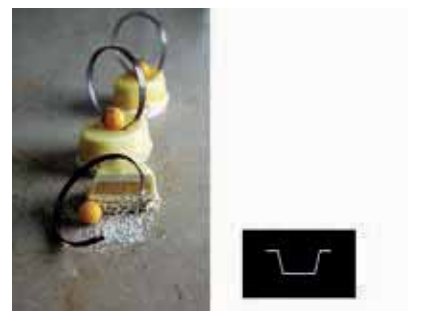

**Small ovals**

Pcs/pz 50 - ml. 20

art. mm.

47740-11 51x31x20





**Small ovals flat bottom**

Pcs/pz 64 - ml. 18

art. mm.

47740-91 57x35x12

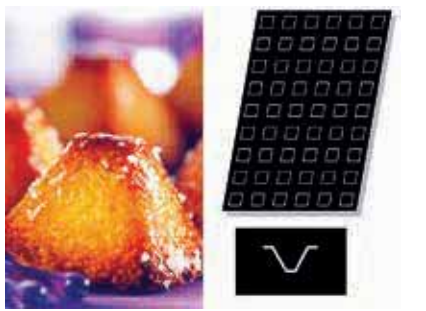

**Small pyramids**

Pcs/pz 54 - ml. 15

art. mm.

47740-12 35x35x23



**Small quenelles**

Pcs/pz 72 - ml. 56

art. mm.

47740-90 42x26x20

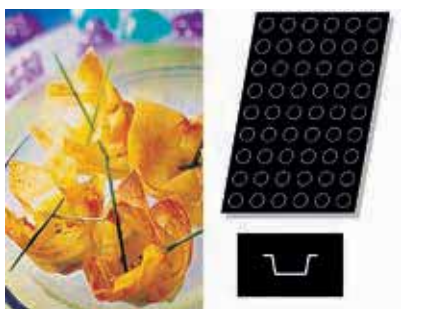

**Small quiches**

Pcs/pz 54 - ml. 22

art. Ø mm. h.

47740-33 40 20



**Small quiches**

Pcs/pz 60 - ml. 13

art. Ø mm. h.

47740-07 42 10



**Small quiches**

Pcs/pz 48 - ml. 20

art. Ø mm. h.

47740-08 48 15

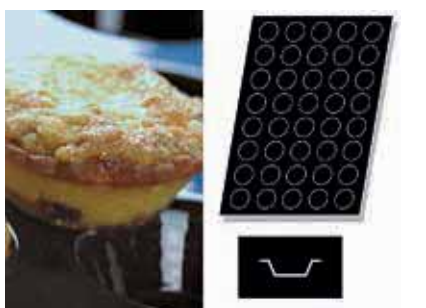

**Small quiches**

Pcs/pz 40 - ml. 35

art. Ø mm. h.

47740-84 58 20

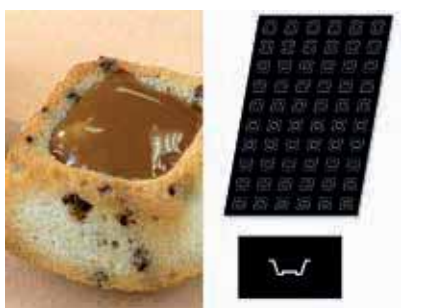

**Small Savarins**

Pcs/pz 60 - ml. 15

art. mm.

47740107 7x37x17



**Small savarins**

Pcs/pz 60 - ml. 10

art. Ø mm. h.

47740-14 41 12



**Small squares**

Pcs/pz 60 - ml. 18

art. mm.

47740116 37x37x17

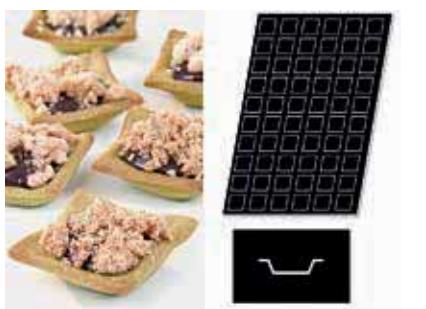

**Small squares**

Pcs/pz 60 - ml. 20

art. mm.

47740109 45x45x12



**Small upside-down half sphere**

Pcs/pz 45 - ml. 6

art. Ø mm. h.

47740-86 26 16





**Spoon**

Pcs/pz 36 - ml. 15

art. mm.

47740118 90x28x12



**Square Savarins**

Pcs/pz 35 - ml. 45

art. mm.

47740108 56x56x24



**Square Savarins**

Pcs/pz 24 - ml. 100

art. mm.

47740-96 70x70x30



**Squares**

Pcs/pz 35 - ml. 60

art. mm.

47740117 56x56x24



**Squares**

Pcs/pz 40 - ml. 40

art. mm.

47740110 60x60x15



**St Honoré crown**

Pcs/pz 6 - ml. 260

art. Ø mm. h.

47740129 150 26



**Stars**

Pcs/pz 24 - ml. 35

art. mm.

47740-88 80x65x15



**Tarte tatin**

Pcs/pz 15 - ml. 135

art. Ø mm. h.

47740-73 82 30



**Teddy bear**

Pcs/pz 18 - ml. 80

art. mm.

47740-53 90x55x20



**Triangles**

Pcs/pz 80 - ml. 7

art. mm.

47740-35 48x41x10



**Various petits-fours**

Pcs/pz 60

art. h.

47740134 22



**Zaphire**

Pcs/pz 54 - ml. 17

art. mm.

47740112 40x40x24



**Zaphire**

Pcs/pz 24 - ml. 75

art. mm.

47740113 70x70x35



**Calisson**

Pcs/pz 20 - ml. 118

art. mm.

47743-03 180x90x50

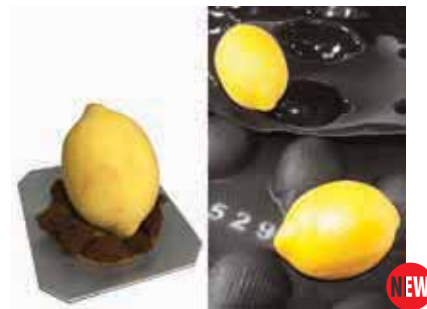

**Lemon**

Pcs/pz 20 - ml. 73

art. mm.

47743-05 85x65x34



**Triangles**

Pcs/pz 24 - ml. 80

art. mm.

47743-10 70x95x25



**Donuts**

Pcs/pz 8

art. Ø mm. h.  
47743-13 88 30



**Insert ring**

Pcs/pz 24

art. Ø mm. h.  
47743-15 61 9



**Ring 3D**

Pcs/pz 24

art. Ø mm. h.  
47743-16 76 25



**Pearls**

Pcs/pz 15 - ml. 100

art. Ø mm. h.  
47743-65 73 40

FLEXIPAN GN 1/1



**Small half sphere**

Pcs/pz 5 - ml. 63

art. Ø mm. h.  
47741-76 23 11

FLEXIPAN CM 40X30



**Small hearts**

Pcs/pz 30 - ml. 15

art. mm.  
47741-78 52x49x10

FLEXIPAN CM 40X30



**Half sphere flat**

Pcs/pz 48 - ml. 10

art. Ø mm. h.  
47741-77 30 13

FLEXIPAN CM 40X30



**Twist**

Pcs/pz 48

art. Ø mm. h.  
47741-00 32 20

FLEXIPAN CM 40X30



**NEW**

**Stars**

Pcs/pz 48

art. Ø mm. h.  
47741-01 32 13

**FLEXIPAN CM 40X30**



**NEW**

**Insert fingers**

Pcs/pz 18

art. mm.  
47741-02 120x11

**FLEXIPAN CM 40X30**



**NEW**

**Sphere 3D**

Pcs/pz 8

art. Ø mm. h.  
47741-05 65 50

**FLEXIPAN CM 40X30**



**Cylinder**

Pcs/pz 24 - ml. 148

art. Ø mm. h.  
47744-30 70 40

**FLEXIPAT CM 60x40**



**Cube**

Pcs/pz 96 - ml. 17

art. mm.  
47744-32 30x30x20

**FLEXIPAT CM 60x40**



**Kougloff**

Pcs/pz 24 - ml. 150

art. Ø mm. h.  
47744-31 80 54

**FLEXIPAT CM 60x40**



**Basic chic**

Pcs/pz 24 - ml. 130

art. mm.  
47744-33 70x70x34

**FLEXIPAT CM 60x40**



**Diamond**

Pcs/pz 24 - ml. 100

art. Ø mm. h.  
47744-34 79 40

**FLEXIPAT CM 60x40**



**Waffles**

Pcs/pz 8 - ml. 100

art. mm.  
47741-38 80x127x15

**FLEXIPAT CM 40X30**



**Fingers**

Pcs/pz 24 - ml. 54

art. mm.  
47741-37 129x28x15

**FLEXIPAT CM 40X30**



**Buche**

art. mm. ml.  
47744-80 280x85x70 140



**Half sphere**

art. Ø mm. h. ml.  
47744-81 180 90 1600



**Flexiform desserts**

| art.     | mm.        | ml. |
|----------|------------|-----|
| 47744-58 | 253x253x45 | 222 |



**Flexiform desserts**

| art.     | mm.        | ml. |
|----------|------------|-----|
| 47744-59 | 600x400x50 | 980 |



**Flexiform desserts**

| art.     | mm.        |
|----------|------------|
| 47744-48 | 480x280x13 |
| 47744-60 | 555x360x10 |
| 47744-62 | 555x360x20 |



**Rosette**

| art.     | Ø mm. |
|----------|-------|
| 47744-10 | 240   |

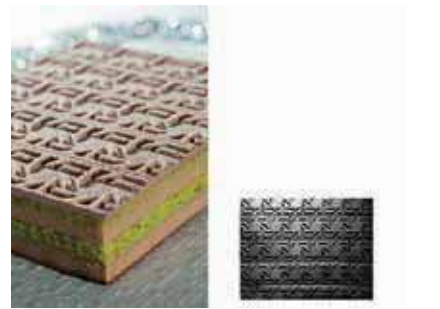

**Venetian cane**

| art.     | mm.     |
|----------|---------|
| 47744-19 | 555x360 |



**Labyrinth**

| art.     | mm.     |
|----------|---------|
| 47744-21 | 600x400 |



**Bubbles**

| art.     | mm.     |
|----------|---------|
| 47744-36 | 600x400 |

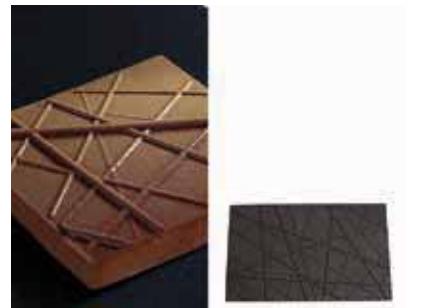

**Mikado**

| art.     | mm.     |
|----------|---------|
| 47744-37 | 600x400 |



**Snowflake**

| art.     | Ø mm. |
|----------|-------|
| 47744-63 | 240   |



**Buche2**

| art.     | mm.     |
|----------|---------|
| 47744-70 | 275x185 |



**Buche1**

| art.     | mm.     |
|----------|---------|
| 47744-71 | 275x185 |



**SILFORM CM 60X40**  
PUFFS - BIGNE' - WINDBEUTEL - CHOUX - BOLLOS



This range has been developed especially for cream puffs dough. The pre-formed shapes make easy obtaining perfect, regular and same size cream puffs. Neither greasing the sheet nor spiking the dough is required before baking. The non-stick property of the material allows an easy and perfect extraction of the pastries. The base of the puff will be clear and plain for a perfect stability.

Supporto alveolare Silform® per cottura di pasta bigné. Questa gamma è stata sviluppata in particolare per la pasta di bigné. Grazie alle impronte preformate, preparare bigné uguali e regolari diventa facile. Non è più indispensabile né spennellare con tuorlo né forare la pasta. Grazie alle proprietà antiaderenti del Silform®, l'estrazione è impeccabile. La base del bigné sarà chiara e netta conferendogli così una perfetta stabilità. Silform® for Choux Pastry.



**Paris-Brest**

| art.     | Ø mm. | h. | ml. | pcs/pz |
|----------|-------|----|-----|--------|
| 41760-27 | 80    | 15 | 50  | 24     |



**Oval choux**

| art.     | mm.      | ml. | pcs/pz |
|----------|----------|-----|--------|
| 41760-26 | 90x60x15 | 56  | 25     |



**Baby choux**

| art.     | Ø mm. | h. | ml. | pcs/pz |
|----------|-------|----|-----|--------|
| 41760-22 | 30    | 5  | 4   | 59     |



**Big choux**

| art.     | Ø mm. | h. | ml. | pcs/pz |
|----------|-------|----|-----|--------|
| 41759-01 | 67    | 15 | 48  | 28     |



**Eclairs - Right handed. Per ambidestri**

| art.     | mm.      | ml. | pcs/pz |
|----------|----------|-----|--------|
| 41760-20 | 125x25x5 | 15  | 18     |



**Eclairs - Left handed. Per mancini.**

| art.     | mm.      | ml. | pcs/pz |
|----------|----------|-----|--------|
| 41760-21 | 125x25x5 | 15  | 18     |

**SILFORM CM 60X40**  
BREADS - PANE - BROT - PAIN - PAN

Silform® baking sheets size 60x40 cm. Especially studied for breads, nonstick and ideal for a variety of small bread shapes: round, hot-dogs rolls, soft rolls, submarines, hamburger buns, sandwiches, etc., etc. Thanks to their perforated texture, the heat transfer is optimized, allowing unique crunchy and coloration. Can be used indifferently on aluminum baking trays or grids.

Supporti di cottura Silform® dim. 60x40 cm. Specifici per pane, antiaderenti, ideali per panini tondi, hot dogs, panini al latte, per hamburger, baguettes, ecc., ecc. La loro texture perforata ottimizza il trasferimento del calore per una perfetta croccantezza e doratura del prodotto. Si utilizzano indifferenteemente su teglie in alluminio o griglie.



**Round shapes/Rotondi**

Pcs/pz 28 - ml. 48

| art.     | Ø mm. | h. mm. |
|----------|-------|--------|
| 41759-01 | 67    | 15     |



**Round shapes/Rotondi**

Pcs/pz 24 - ml. 65

| art.     | Ø mm. | h. mm. |
|----------|-------|--------|
| 41759-02 | 75    | 17     |



**Round shapes/Rotondi**

Pcs/pz 24 - ml. 65

| art.     | Ø mm. | h. mm. |
|----------|-------|--------|
| 41759-03 | 79    | 15     |



**Round shapes/Rotondi**

Pcs/pz 15 - ml. 140

| art.     | Ø mm. | h. mm. |
|----------|-------|--------|
| 41759-05 | 102   | 20     |



**Round shapes/Rotondi**

Pcs/pz 11 - ml. 175

| art.     | Ø mm. | h. mm. |
|----------|-------|--------|
| 41759-09 | 125   | 16     |



**Oval shapes/Ovali**

Pcs/pz 24 - ml. 80

| art.     | mm.   | h. mm. |
|----------|-------|--------|
| 41760-02 | 95x40 | 30     |



**Oval shapes/Ovali**

Pcs/pz 18

| art.     | mm.    | h. mm. |
|----------|--------|--------|
| 41760-05 | 155x41 | 25     |



**Oval shapes/Ovali**

Pcs/pz 12

| art.     | mm.    | h. mm. |
|----------|--------|--------|
| 41760-06 | 169x64 | 30     |



**Oval shapes/Ovali**

Pcs/pz 8

| art.     | mm.    | h. mm. |
|----------|--------|--------|
| 41760-08 | 259x64 | 30     |



**Oval shapes/Ovali**

Pcs/pz 6

| art.     | mm.    | h. mm. |
|----------|--------|--------|
| 41760-09 | 299x60 | 30     |





**French loaves perforated sheet, silicone coated**

Teglia alluminio forato, siliconata  
Pariserbrotblech, Silikon-beschichtet  
Plaque perforée pain parisien, siliconée  
Placa pan perforada, siliconada

| art.     | cm.   | pcs/pz |
|----------|-------|--------|
| 41758-53 | 53x32 | 4      |
| 41758-60 | 60x40 | 5      |
| 41758-65 | 65x43 | 6      |
| 41758-85 | 85x43 | 6      |

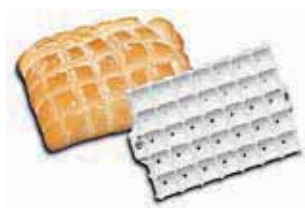

**ABS**

**Bread mould**  
Stampo per pane  
Brot-Ausstechforme  
Découpoir à pain  
Cortador para pan

| art.     | cm.   |
|----------|-------|
| 47041-01 | 14x10 |



**ABS**

**Bread mould**  
Stampo per pane  
Brot-Ausstechforme  
Découpoir à pain  
Cortador para pan

| art.     | cm.   |
|----------|-------|
| 47041-02 | 14x11 |



**ABS**

**Bread mould**  
Stampo per pane  
Brot-Ausstechforme  
Découpoir à pain  
Cortador para pan

| art.     | Ø cm. |
|----------|-------|
| 47041-03 | 12,5  |



**ABS**

**Bread mould**  
Stampo per pane  
Brot-Ausstechforme  
Découpoir à pain  
Cortador para pan

| art.     | cm.      |
|----------|----------|
| 47041-04 | 16,5x8,5 |



**ABS**

**Bread mould**  
Stampo per pane  
Brot-Ausstechforme  
Découpoir à pain  
Cortador para pan

| art.     | Ø cm. |
|----------|-------|
| 47041-05 | 12,5  |



**ABS**

**Bread mould**  
Stampo per pane  
Brot-Ausstechforme  
Découpoir à pain  
Cortador para pan

| art.     | Ø cm. |
|----------|-------|
| 47041-06 | 8     |



**ABS**

**Bread mould**  
Stampo per pane  
Brot-Ausstechforme  
Découpoir à pain  
Cortador para pan

| art.     | Ø cm. |
|----------|-------|
| 47041-07 | 8     |



**ABS**

**Bread mould**  
Stampo per pane  
Brot-Ausstechforme  
Découpoir à pain  
Cortador para pan

| art.     | Ø cm. |
|----------|-------|
| 47041-08 | 8     |



**ABS**

**Bread mould**  
Stampo per pane  
Brot-Ausstechforme  
Découpoir à pain  
Cortador para pan

| art.     | Ø cm. |
|----------|-------|
| 47041-15 | 8     |





**ABS**

**Kaiser bread marker**  
 Marcatore pane Kaiser  
 Kaiserbrot Stempel  
 Empreinte pain Kaiser  
 Molde pan Kaiser

| art.     | Ø cm. | l. cm. |
|----------|-------|--------|
| 47040-00 | 6     | 20     |



**Bread brush**  
 Spazzola pane  
 Brot-Bürste  
 Brosse à pain  
 Cepillo para pan

| art.     | l. cm. |
|----------|--------|
| 42614-04 | 24,5   |
| 42614-05 | 32,0   |
| 42614-06 | 41,0   |
| 42614-07 | 46,0   |



**SS**

**Disposable baker's blades**  
 Lama panettiere usa e getta  
 Einweg-Bäcker-Klingen  
 Incisette boulanger jetables  
 Láminas del panadero desechables

| art.     | l. cm. | pcs/pz |
|----------|--------|--------|
| 48290-10 | 12     | 10     |



**PE**

**Bread basket**  
 Cesta pane  
 Brot-Korb  
 Corbeille à pain  
 Cesta pan

| art.     | cm.      | lt. |
|----------|----------|-----|
| 44982-04 | 57x36x34 | 40  |
| 44982-06 | 66x45x35 | 60  |
| 44982-10 | 78x52x40 | 100 |



**PP**

**Bread proofing basket**  
 Cestino impasto  
 Gärkorb  
 Banneton  
 Molde para pan

| art.     | Ø cm. | h.  | gr.  | col. |
|----------|-------|-----|------|------|
| 47042-19 | 19    | 7,5 | 500  | ●    |
| 47042-22 | 22    | 9,3 | 1000 | ●    |
| 47042-25 | 25    | 9,0 | 1500 | ●    |



**PP**

**Bread proofing basket**  
 Cestino impasto  
 Gärkorb  
 Banneton  
 Molde para pan

| art.     | cm.       | gr.  | col. |
|----------|-----------|------|------|
| 47043-27 | 27x12x6,5 | 500  | ●    |
| 47043-35 | 35x13x7,2 | 1000 | ●    |
| 47043-42 | 42x14x7,5 | 1500 | ●    |



# ETHNIC CUISINE CUCINA ETNICA

ASIA FUSION



The images of the products in this chapter reflect the characteristics of the products in the warehouse. However, they have to be considered mainly for illustrative purposes only. Although we make every effort to display the products accurately, the products received may vary slightly from those images. In any case the changes are intended as improvements and do not alter the function, nor lessen the utility of the product.

Tutte le foto degli articoli presenti nel capitolo rispecchiano il più possibile le caratteristiche dei prodotti presenti in magazzino. Teniamo comunque a precisare che le immagini sono indicative ed i prodotti reali potrebbero differire nei colori e nelle dimensioni. Le variazioni sono in ogni caso migliorative e tali da non alterare la natura e la funzionalità del prodotto stesso.

FINE MELAMINE SERIES THARA



Withstands temperatures from -20°C to +70°C.

Termoresistenti da -20°C a +70°C.



**Rice bowl**  
Coppa riso  
Reistasse  
Bol à riz  
Copa arroz

| art.     | Ø cm. | h. | lt. | col. |
|----------|-------|----|-----|------|
| 44463-11 | 11    | 7  | 0,3 | ●    |



**Tray**  
Vassoio  
Platte  
Plateau  
Placa

| art.     | dim. cm.   | col. |
|----------|------------|------|
| 44464-23 | 23,5x7,5x2 | ●    |



**Tray**  
Vassoio  
Platte  
Plateau  
Placa

| art.     | dim. cm.     | col. |
|----------|--------------|------|
| 44465-24 | 24,5x6,5x1,5 | ●    |



**Bowl**  
Ciotola  
Schüssel  
Bol  
Bol Ensalada

| art.     | Ø cm. | h.  | col. |
|----------|-------|-----|------|
| 44452-31 | 31    | 8,5 | ○    |
| 44452B31 | 31    | 8,5 | ●    |



**Bowl**  
Ciotola  
Schüssel  
Bol  
Bol Ensalada

| art.     | dim. cm.    | col. |
|----------|-------------|------|
| 44453-14 | 14,5x12x5,5 | ○    |
| 44453B14 | 14,5x12x5,5 | ●    |



**Bowl**  
Ciotola  
Schüssel  
Bol  
Bol Ensalada

| art.     | Ø cm. | h. | col. |
|----------|-------|----|------|
| 44454-11 | 11,5  | 4  | ○    |
| 44454B11 | 11,5  | 4  | ●    |



**Bowl**  
Ciotola  
Schüssel  
Bol  
Bol Ensalada

| art.     | dim. cm. | col. |
|----------|----------|------|
| 44455-09 | 9x7x2,5  | ○    |
| 44455B09 | 9x7x2,5  | ●    |



**Bowl**  
Ciotola  
Schüssel  
Bol  
Bol Ensalada

| art.     | dim. cm. | col. |
|----------|----------|------|
| 44456-14 | 14x9x2,5 | ○    |
| 44456B14 | 14x9x2,5 | ●    |



**Bowl**  
Ciotola  
Schüssel  
Bol  
Bol Ensalada

| art.     | dim. cm.  | col. |
|----------|-----------|------|
| 44457-32 | 32,5x14x4 | ○    |
| 44457B32 | 32,5x14x4 | ●    |





**Tray**  
Vassoio  
Platte  
Plateau  
Placa

| art.     | dim. cm.  | col. |
|----------|-----------|------|
| 44461-20 | 20x20x4,5 | ○    |
| 44461B20 | 20x20x4,5 | ●    |



**Bowl**  
Ciotola  
Schüssel  
Bol  
Bol Ensalada

| art.     | dim. cm. | col. |
|----------|----------|------|
| 44450-21 | 21x21x11 | ○    |
| 44450B21 | 21x21x11 | ●    |



**Bowl**  
Ciotola  
Schüssel  
Bol  
Bol Ensalada

| art.     | dim. cm. | col. |
|----------|----------|------|
| 44450-12 | 12x12x4  | ○    |
| 44450B12 | 12x12x4  | ●    |



**Bowl**  
Ciotola  
Schüssel  
Bol  
Bol Ensalada

| art.     | dim. cm.    | col. |
|----------|-------------|------|
| 44450-17 | 17,5x17,5x7 | ○    |
| 44450B17 | 17,5x17,5x7 | ●    |



**Tray**  
Vassoio  
Platte  
Plateau  
Placa

| art.     | dim. cm. | col. |
|----------|----------|------|
| 44451-22 | 22x12x3  | ○    |
| 44451B22 | 22x12x3  | ●    |



**Tray**  
Vassoio  
Platte  
Plateau  
Placa

| art.     | dim. cm.  | col. |
|----------|-----------|------|
| 44462-25 | 25x25x5,5 | ○    |
| 44462B25 | 25x25x5,5 | ●    |



**Dish**  
Piatto  
Teller  
Assiette  
Plato

| art.     | Ø cm. | h. | col. |
|----------|-------|----|------|
| 44459-28 | 28    | 3  | ○    |
| 44459B28 | 28    | 3  | ●    |



**Bowl**  
Ciotola  
Schüssel  
Bol  
Bol Ensalada

| art.     | dim. cm. | h. | col. |
|----------|----------|----|------|
| 44450-11 | 11x10    | 3  | ○    |
| 44450B11 | 11x10    | 3  | ●    |



**Bowl**  
Ciotola  
Schüssel  
Bol  
Bol Ensalada

| art.     | dim. cm. | h.  | col. |
|----------|----------|-----|------|
| 44450-13 | 13x11    | 3,5 | ○    |
| 44450B13 | 13x11    | 3,5 | ●    |



**Bowl**  
Ciotola  
Schüssel  
Bol  
Bol Ensalada

| art.     | dim. cm.      | col. |
|----------|---------------|------|
| 44450-15 | 17,5x15,5x5,5 | ○    |
| 44450B15 | 17,5x15,5x5,5 | ●    |



**Tray**  
Vassoio  
Platte  
Plateau  
Placa

| art.     | dim. cm.    | col. |
|----------|-------------|------|
| 44450-23 | 22x23,5x5,5 | ○    |
| 44450B23 | 22x23,5x5,5 | ●    |





MF

**Soba choko cup with cover**

Tazza soba choko con coperchio  
Soba Choko-Schale mit Deckel  
Coupe soba choko avec couvercle  
Taza soba choko con tapa

art. Ø cm. h.  
49655-47 8,5 6,5



MF

**Soup/rice bowl with lid**

Ciotola riso con coperchio  
Reisschüssel mit Deckel  
Bol à riz avec couvercle  
Bol arroz con tapa

art. Ø cm. h.  
49655-34 10 10



MF

**Zaru soba tray**

Vassoio zarusoba  
Zaru Soba-Tablett  
Plateau zaru soba  
Bandeja zaru soba

art. dim. cm.  
49655-48 19,5x19,5



MF

**Towel tray**

Vassoio portatovagliolo  
Handtuch-Tablett  
Plateau à serviette  
Bandeja servilleta

art. dim. cm.  
49655-46 17x7



MF

**Double Sided Tray**

Vassoio reversibile  
Platte, doppelseitig  
Plateau double face  
Bandeja doble cara

art. dim. cm.  
49655-20 35x31



MF

**Bento tray**

Vassoio bento  
Bento-Platte  
Plateau à bento  
Bandeja bento

art. dim. cm.  
49655-36 22x16x3,5



MF

**Bento box with lid**

Scatola bento con coperchio  
Bento-Box mit Deckel  
Boîte à bento avec couvercle  
Caja bento con tapa

art. dim. cm.  
49655-44 30x24



MF

**Bento box with lid**

Scatola bento con coperchio  
Bento-Box mit Deckel  
Boîte à bento avec couvercle  
Caja bento con tapa

art. dim. cm.  
49655-37 24x24x5,5



MF

**Sushi serving dish**

Piatto a servire  
Sushi-Servierteller  
Plat à sushi  
Plato para sushi

art. Ø cm. h.  
49655-21 22 5,5  
49655-22 25 6  
49655-23 28 6



MF

**Sushi-sashimi bridge**

Ponte per sushi e sashimi  
Sushi-Brücke  
Sushi et sashimi pont  
Puente para sushi-sashimi

art. dim. cm.  
49655-41 28x13,5x6



B

**Sushi geta board**

Tagliere sushi  
Sushibrett  
Planche à sushi  
Tabla para sushi

art. dim. cm.  
49655-24 24x15x3





**MF**

**Hand roll stand, laquered**  
Supporto per temaki, laccato  
Temaki-Ständer  
Support pour temaki  
Soporte para temaki

art. dim. cm.  
49655-32 18x9,5x8



**W**

**Hand roll stand**  
Supporto per temaki  
Temaki-Ständer  
Support pour temaki  
Soporte para temaki

art. dim. cm.  
49655-31 18x9x8,5



**MF**

**Sushi-sashimi boat**  
Barca per sushi e sashimi  
Sushi-Sashimi-Boot  
Bateau sushi et sashimi  
Barco sushi-sashimi

art. dim. cm.  
49655-45 28x13,5x6



**B**

**Sushi-sashimi boat**  
Barca per sushi e sashimi  
Sushi-Sashimi-Boot  
Bateau sushi et sashimi  
Barco sushi-sashimi

art. dim. cm.  
49655-29 34x12x10,5



**MF**

**Soup spoon**  
Cucchiaio brodo  
Suppenlöffel  
Cuiller à soupe  
Cuchara sopa

art. dim. cm. col.  
44850-13 13,5x4,5 ○  
44850B13 13,5x4,5 ●



**MF**

**Soup spoon**  
Cucchiaio brodo  
Suppenlöffel  
Cuiller à soupe  
Cuchara sopa

art. l. cm.  
49655-35 14,5



**PR**

**Sauce pourer**  
Salsiera  
Sauciere  
Saucière  
Salsera

art. dim. cm. lt. U. Pack  
67305-57 7x11 0,2 6  
67308-57 5x4 0,03 6



**PR**

**Flat plate**  
Piattino piano  
Teller flach  
Petite assiette plate  
Platillo llano

art. dim. cm. U. Pack  
67303Q80 9x9 6  
67303Q81 12x12 6



**PR**

**Deep plate**  
Piattino fondo  
Teller tief  
Petite assiette creuse  
Platillo hondo

art. dim. cm. U. Pack  
67303Q82 9x9 6  
67303Q83 12x12 6



**PR**

**Small dish**  
Ciotolina  
Schale  
Petite assiette  
Platillo

art. dim. cm. U. Pack  
67303M01 9x7x3 6



**PR**

**Small dish**  
Piattino  
Schale  
Petite assiette  
Platillo

art. Ø cm. h. U. Pack  
67303M04 10,5 2 6



PR

**Small dish**  
Piattino  
Schale  
Petite assiette  
Platillo

| art.     | dim. cm. | U. Pack |
|----------|----------|---------|
| 67303M02 | 14x7x2   | 6       |



PR

**Small dish**  
Ciotolina  
Schale  
Petite assiette  
Platillo

| art.     | Ø cm. | h. | U. Pack |
|----------|-------|----|---------|
| 67303M03 | 10    | 2  | 6       |



PR

**Small dish**  
Ciotolina  
Schale  
Petite assiette  
Platillo

| art.     | dim. cm. | U. Pack |
|----------|----------|---------|
| 67303M05 | 11x8     | 6       |
| 67303M06 | 16x11    | 6       |



PR

**Chinese spoon**  
Cucchiaio cinese  
Löffel  
Cuillère chinoise  
Cucharita

| art.     | l. cm. | U. Pack |
|----------|--------|---------|
| 67303M07 | 13     | 12      |



PR

**Sake jug**  
Caraffa sake  
Sakekrug  
Carafe à sake  
Jarra sake

| art.     | Ø cm. | h.   | ml. | col. |
|----------|-------|------|-----|------|
| 49655-25 | 5,2   | 13,5 | 120 | ○    |
| 49655-42 | 5,7   | 18,0 | 250 | ○    |



PR

**Sake jug**  
Caraffa sake  
Sakekrug  
Carafe à sake  
Jarra sake

| art.     | Ø cm. | h.   | ml. | col. |
|----------|-------|------|-----|------|
| 49655-57 | 5,2   | 13,5 | 130 | ●    |
| 49655-58 | 5,7   | 18,0 | 230 | ●    |



PR

**Sake cup**  
Coppetta sake  
Sakebecher  
Coupe à sake  
Copa sake

| art.     | Ø cm. | h.  | ml. |
|----------|-------|-----|-----|
| 49655-26 | 4,5   | 4,5 | 40  |



PR

**Sake cup**  
Coppetta sake  
Sakebecher  
Coupe à sake  
Copa sake

| art.     | Ø cm. | h.  | ml. | col. |
|----------|-------|-----|-----|------|
| 49655-43 | 4,5   | 5,5 | 40  | ○    |
| 49655-60 | 4,5   | 5,5 | 40  | ●    |



PR

**Sake cup**  
Coppetta sake  
Sakebecher  
Coupe à sake  
Copa sake

| art.     | Ø cm. | h. |
|----------|-------|----|
| 49655-56 | 5     | 4  |



PR

**Sake jug**  
Caraffa sake  
Sakekrug  
Carafe à sake  
Jarra sake

| art.     | Ø cm. | h.  |
|----------|-------|-----|
| 49655-55 | 6     | 9,5 |



PR

**Sake warmer**  
Riscalda sake  
Sakewärmer  
Réchaud à sake  
Calentador de sake

| art.     | Ø cm. | h. |
|----------|-------|----|
| 49655-54 | 9,5   | 9  |



PR

**Soy pot**  
Vaso soia  
Sojakrug  
Carafe soja sauce  
Jarra soja

| art.     | Ø cm. | h.  |
|----------|-------|-----|
| 49655-52 | 12    | 7,5 |





**PR**

**Soy pot**

Vaso soia  
Sojakrug  
Carafe soja sauce  
Jarra soja

| art.     | Ø cm. | h. |
|----------|-------|----|
| 49655-51 | 6,5   | 7  |



**PR**

**Soy pot**

Vaso soia  
Sojakrug  
Carafe soja sauce  
Jarra soja

| art.     | Ø cm. | h.  | ml. |
|----------|-------|-----|-----|
| 49655-53 | 5,5   | 8,5 | 130 |



**PR**

**Chopstick rest**

Supporto bacchette cinesi  
Ess-Stäbchen Ablage  
Pose baguettes  
Soporte para palillos

| art.     | dim. cm. | col. |
|----------|----------|------|
| 49655-27 | 4,5x3    | ●    |
| 49655-28 | 4,5x3    | ○    |



**PR**

**Chopstick rest**

Supporto bacchette cinesi  
Ess-Stäbchen Ablage  
Pose baguettes  
Soporte para palillos

| art.     | dim. cm. |
|----------|----------|
| 49655-61 | 6x1,5    |



**MF**

**Chopsticks**

Bacchette cinesi  
Ess-Stäbchen  
Baguettes  
Palillos

| art.     | l. cm. | pcs/pz |
|----------|--------|--------|
| 49658-01 | 27     | 2x10   |



**MF**

**Chopsticks**

Bacchette cinesi  
Ess-Stäbchen  
Baguettes  
Palillos

| art.     | l. cm. | pcs/pz |
|----------|--------|--------|
| 49658-02 | 27     | 2x10   |



**B**

**Disposable chopsticks**

Bacchette monouso  
Einweg Ess-Stäbchen  
Baguettes jetables  
Palillos desechables

| art.     | l. cm. | pcs/pz |
|----------|--------|--------|
| 48300-29 | 21     | 2x50   |



**B**

**Disposable chopsticks**

Bacchette monouso  
Einweg Ess-Stäbchen  
Baguettes jetables  
Palillos desechables

| art.     | l. cm. | pcs/pz |
|----------|--------|--------|
| 49627-22 | 24     | 2x100  |



**Japanese chopsticks, assorted colors**

Bacchette giapponesi, colori assortiti  
Japanische-Ess-Stäbchen  
Baguettes japonaises  
Palillos japoneses

| art.     | l. cm. | pcs/pz |
|----------|--------|--------|
| 49628-00 | 24     | 2x1    |



**SS**

**Japanese chopsticks**

Bacchette giapponesi  
Japanische-Ess-Stäbchen  
Baguettes japonaises  
Palillos japoneses

| art.     | l. cm. | pcs/pz |
|----------|--------|--------|
| 49655-30 | 23     | 2x5    |



**B**

**Noshikushi skewers**

Spiedini noshikushi  
Noshikushi Spieße  
Brochettes noshikushi  
Pinchos noshikushi

| art.     | l. cm. | pcs/pz |
|----------|--------|--------|
| 48300-42 | 10,5   | 100    |



**B**

**Tepokushi skewers**

Spiedini tepokushi  
Tepokushi Spieße  
Brochettes tepokushi  
Pinchos tepokushi

| art.     | l. cm. | pcs/pz |
|----------|--------|--------|
| 48300-43 | 9      | 100    |
| 48300-33 | 15     | 100    |





NEW

W

**Mooncake mould flower**

Stampo mooncake flower  
Mondkuchenform Flower  
Moule à mooncake flower  
Molde mooncake flower

art.

49664-01



NEW

W

**Mooncake mould fish**

Stampo mooncake fish  
Mondkuchenform Fish  
Moule à mooncake fish  
Molde mooncake fish

art.

49664-02



NEW

W

**Mooncake mould long life**

Stampo mooncake long life  
Mondkuchenform Long Life  
Moule à mooncake long life  
Molde mooncake long life

art.

49664-03



NEW

W

**Mooncake mould long life acadia**

Stampo mooncake long life acadia  
Mondkuchenform Long Life Acadia  
Moule à mooncake long life acadia  
Molde mooncake long life acadia

art.

49664-04



NEW

W

**Mooncake mould double flower**

Stampo mooncake double flower  
Mondkuchenform Double Flower  
Moule à mooncake double flower  
Molde mooncake double flower

art.

49664-05



B

**Sushi mat**

Stuoietta  
Sushi-Matte  
Natte à rouler les sushis  
Mantelín para sushi

art.

dim. cm.

49626-00 24x24



B

**Sushi mat**

Stuoietta  
Sushi-Matte  
Natte à rouler les sushis  
Mantelín para sushi

art.

dim. cm.

49626-02 27x27

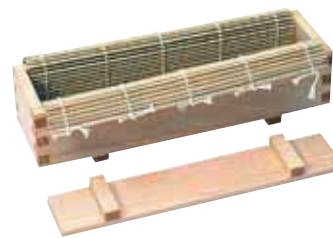

**Sushi-maki set 3 pcs**

Kit 3 pz per sushi-maki  
Sushi-Maki-Satz 3 Stk  
Kit 3 pcs pour réaliser les sushi-maki  
Juego 3 pz para sushi-maki

art.

dim. cm.

49655-02 26x7,5x6



**Maki roll mould**

Stampo per maki  
Maki-Ausstechform  
Moule à maki  
Molde para maki

art.

dim. cm.

49655-10 20,5x4x4



**Nigiri mould**

Stampo per nigiri  
Nigiri-Ausstechform  
Moule à nigiri  
Molde para nigiri

art.

dim. cm.

49655-16 16x6x2,5



MF

**Rice spoon**

Cucchiaio riso  
Reislöffel  
Cuiller à riz  
Cuchara arroz

art.

dim. cm.

49655-03 22x7



**B**

**Steamer**

Cuocivapore  
Dampfgarer  
Panier vapeur  
Vaporera

| art.     | Ø cm. |
|----------|-------|
| 49603-15 | 16    |
| 49603-20 | 20    |
| 49603-25 | 25    |
| 49603-30 | 30    |
| 49603-40 | 40    |
| 49603-50 | 50    |

**2 bodies + 1 cover.** – 2 ceste + 1 coperchio.



**B**

**Steamer**

Cuocivapore  
Dampfgarer  
Panier vapeur  
Vaporera

| art.     | dim. cm.  |
|----------|-----------|
| 49656-15 | 15,2x15,2 |
| 49656-16 | 16,5x16,5 |
| 49656-20 | 20,3x20,3 |



**W**

**Hangiri/sushi rice tub**

Vasca riso hangiri  
Hangiri/Sushi-Reis-Wanne  
Cuve è riz sushi/hangiri  
Barril arroz sushi/hangiri

| art.     | Ø cm. |
|----------|-------|
| 49655-49 | 45    |
| 49655-50 | 60    |



**NEW**

**Serving basket sticky rice**

Contentitore per riso dolce  
Klebreis-Servierkorb  
Panier de service à riz gluant  
Cesta para servir arroz pegado

| art.     | Ø cm. |
|----------|-------|
| 49660-09 | 9,5   |
| 49660-13 | 13,0  |

**Bamboo.**



**NEW**

**Sticky rice lao pot**

Pentola per riso dolce  
Klebreis Laotopf  
Marmite à riz gluant  
Olla para arroz pegado

| art.     | Ø cm. |
|----------|-------|
| 49661-22 | 22    |
| 49661-24 | 24    |

**Aluminum.** – Alluminio.



**NEW**

**Sticky rice lao basket**

Cesto per riso dolce  
Klebreis-Laokorb  
Panier cuisson à riz gluant  
Cesta de cocción arroz pegado

| art.     | Ø cm. |
|----------|-------|
| 49662-40 | 40    |
| 49662-50 | 50    |

**Bamboo.**



**NEW**

**Sticky rice cooking set**

Set cottura riso dolce  
Klebreis Kochset  
Ensemble de cuisson riz gluant  
Set de cocina arroz pegado

| art.     | Ø cm. |
|----------|-------|
| 49663-22 | 22    |
| 49663-24 | 24    |

**Aluminum and bamboo.** – Alluminio e bamboo.



**Wok with grid and cover, 3-ply**

Wok c/griglia e coperchio, 3-ply  
Wok mit Rost und Deckel, 3-ply  
Wok avec grille et couvercle, 3-ply  
Wok con rejilla y tapa, 3-ply

| art.     | Ø cm. | h. |
|----------|-------|----|
| 12529-32 | 32    | 8  |



**Steel wok pan**

Wok, ferro  
Wok-Eisenpfanne  
Poêle chinoise, acier  
Wok, hierro

| art.     | Ø cm. | h. |
|----------|-------|----|
| 11713-32 | 32    | 10 |
| 11713-40 | 40    | 11 |



**Steel wok pan**

Wok, ferro  
Wok-Eisenpfanne  
Poêle chinoise, acier  
Wok, hierro

| art.     | Ø cm. | h. |
|----------|-------|----|
| 49604-31 | 30,5  | 9  |
| 49604-36 | 35,5  | 11 |
| 49604-41 | 40,5  | 12 |



**Non stick wok**

Wok antiaderente  
Wok-Pfanne, nichttafend  
Poêle chinoise, anti-adhérente  
Wok, antiaderente

| art.     | Ø cm. |
|----------|-------|
| 49612-30 | 30,5  |
| 49612-33 | 33,0  |



**Wok stand, chromed**

Base per wok, cromata  
Fuss für Wokpfanne, verchromt  
Base pour wok, chromée  
Base para Wok, cromada

| art.     | Ø cm. | h.  |
|----------|-------|-----|
| 49600-00 | 20-25 | 5,5 |



NEW

SS

**Rice steamer shelf**

Supporto per cottura a vapore  
Reis-Dampfer-Fuss  
Étagère à vapeur  
Estante de cocción al vapor

| art.     | Ø cm. | h.  |
|----------|-------|-----|
| 49653-10 | 10,0  | 7,5 |
| 49653-12 | 12,5  | 7,5 |
| 49653-15 | 15,0  | 7,5 |
| 49653-17 | 18,0  | 7,5 |
| 49653-20 | 20,0  | 7,5 |

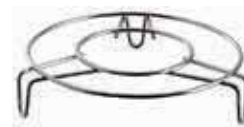

NEW

SS

**Rice steamer shelf**

Supporto per cottura a vapore  
Reis-Dampfer-Fuss  
Étagère à vapeur  
Estante de cocción al vapor

| art.     | Ø cm. | h.  |
|----------|-------|-----|
| 49652-10 | 10,0  | 2,5 |
| 49652-12 | 12,5  | 2,5 |
| 49652-15 | 15,0  | 2,5 |
| 49652-17 | 18,0  | 2,5 |
| 49652-20 | 20,0  | 2,5 |

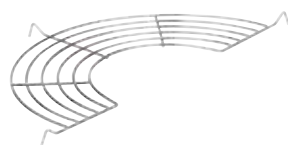

**Tempura rack, chromed**

Griglia per tempura, cromata  
Tempura-Rost, verchromt  
Grille à tempura, chromée  
Rejilla para tempura, cromada

| art.     | Ø cm. |
|----------|-------|
| 49613-30 | 30,5  |
| 49613-33 | 33,0  |
| 49613-35 | 35,5  |



NEW

SS

**Steam rack**

Griglia per cottura a vapore  
Dämpf-Rost  
Grille à vapeur  
Rejilla

| art.     | Ø cm. |
|----------|-------|
| 49654-15 | 15,2  |
| 49654-20 | 20,3  |
| 49654-25 | 25,4  |



NEW

SS

**Dim Sum steam rack**

Griglia Dim Sum  
Dim Sum Dämpf-Rost  
Grille Dim Sum  
Rejilla Dim Sum

| art.     | Ø cm. |
|----------|-------|
| 49659-24 | 24,0  |
| 49659-26 | 26,0  |

**Flat bottom. – Fondo piano.**



**Steel wok pan**

Wok, ferro  
Wok-Eisenpfanne  
Poêle chinoise, acier  
Wok, hierro

| art.     | Ø cm. | h.   |
|----------|-------|------|
| 49605-46 | 45,5  | 14,0 |
| 49605-61 | 61,0  | 18,5 |
| 49605-71 | 71,0  | 22,0 |



**Wok lid, aluminum**

Coperchio per wok, alluminio  
Wok-Deckel, Aluminium  
Couverture pour poêle chinoise, alu  
Tapa para wok, aluminio

| art.     | Ø cm. | h.   |
|----------|-------|------|
| 49602-25 | 24,5  | 4,5  |
| 49602-30 | 29,5  | 6,2  |
| 49602-33 | 32,0  | 9,0  |
| 49602-35 | 34,5  | 10,3 |



SS

**Wok stand**

Base per wok  
Fuss für Wokpfanne  
Base pour wok  
Base para Wok

| art.     | Ø cm. |
|----------|-------|
| 11953-22 | 22    |



**Agemono pot and stand**

Casseruola con supporto  
Kasserolle mit Untersetzer  
Casserole avec support  
Cacerola con soporte

| art.     | Ø cm. |
|----------|-------|
| 49655-64 | 20    |



**Toban skillet**

Padella Toban  
Toban-Pfanne  
Poêle Toban  
Sartén Toban

| art.     | Ø cm. |
|----------|-------|
| 49655-40 | 19    |



**Balti pan**

Padella balti/karahi  
Balti-Pfanne  
Poêle balti  
Sartén balti

| art.     | Ø cm. |
|----------|-------|
| 49657-15 | 15,2  |
| 49657-20 | 20,3  |
| 49657-25 | 25,4  |

**Carbon steel.** – Acciaio al carbonio.



**Balti pan with wood base**

Padella balti base legno  
Balti-Pfanne mit Holz-Basis  
Poêle balti avec base en bois  
Sartén balti base de madera

| art.     | Ø cm. |
|----------|-------|
| 49656-02 | 15,2  |

**Carbon steel.** – Acciaio al carbonio.



**Steel fry pan**

Padella per friggere, ferro  
Frittier-Eisenpfanne  
Tuile à frire, acier  
Sartén freidora, hierro

| art.     | Ø cm. | h.   | lt.  |
|----------|-------|------|------|
| 41707-32 | 32    | 9,8  | 6,0  |
| 41707-36 | 36    | 11,0 | 8,8  |
| 41707-40 | 40    | 13,4 | 12,2 |
| 41707-45 | 45    | 15,0 | 17,3 |
| 41707-50 | 50    | 17,6 | 23,5 |



**Wire basket, tinned**

Cestello per friggere, stagnato  
Frittier-Rost, verzinkt  
Grille à frire, étamée  
Cesta escurrefrito, estañada

| art.     | Ø cm. | h.   |
|----------|-------|------|
| 41708-32 | 32    | 11,0 |
| 41708-36 | 36    | 11,5 |
| 41708-40 | 40    | 12,4 |
| 41708-45 | 45    | 15,5 |
| 41708-50 | 50    | 16,5 |



**Japanese omelettes pan, non-stick**

Padella omelette, antiaderente  
Japanische Omelette Pfanne mit Antihafbeschichtung  
Poêle à omelettes, revêtement anti-adhésif  
Sartén antiaderente para tortillas japonesas

| art.     | dim. cm.  |
|----------|-----------|
| 49655-38 | 22x24x3,5 |



**NEW**



**Tamagoyaki pan**

Padella Tamagoyaki  
Tamagoyaki-Pfanne  
Poêle à Tamagoyaki  
Sartén Tamagoyaki

| art.     | dim. cm. |
|----------|----------|
| 49655-66 | 18x15x3  |



**Steel tawa pan**

Padella tawa, ferro  
Tawa-Eisenpfanne  
Poêle tawa, acier  
Sartén tawa, hierro

art. Ø cm.  
49614-28 28

Used in Indian cooking, for chapattis and anything that needs quick cooking at high temperatures. – Utilizzate nella cucina indiana, per focacce e tutto ciò che ha bisogno di cottura rapida ad alta temperatura.



SS

**Steamer**

Cuocivapore  
Dampf-Kocher  
Cuisneur à vapeur  
Cuscusera

| art.     | Ø cm. | h. |
|----------|-------|----|
| 49606-51 | 51    | 14 |
| 49606-00 | 51    | 14 |
| 49606-01 | 51    | 20 |



**Scoop**

Porzionatore  
Portionierer  
Cuiller  
Racionador

art.  
49616S01  
49616B01



**Chinese hot pot, aluminium**

Pentola cinese, alluminio  
Chinese-Suppentopf, Alu  
Marmite chinoise, alu  
Olla chino, aluminio

| art.     | Ø cm. | h. |
|----------|-------|----|
| 49616-22 | 22    | 17 |
| 49616-24 | 24    | 20 |
| 49616-26 | 26    | 22 |



**Clay pot**

Casseruola terracotta  
Tontopf  
Pot d'argile  
Olla de barro

| art.     | Ø cm. | h. | Kg. |
|----------|-------|----|-----|
| 49632-24 | 23    | 10 | 1,5 |
| 49632-32 | 32    | 16 | 2,7 |



**Clay pot**

Casseruola terracotta  
Tontopf  
Pot d'argile  
Olla de barro

| art.     | Ø cm. | h. | Kg.  |
|----------|-------|----|------|
| 49633-22 | 22    | 10 | 0,75 |
| 49633-24 | 24    | 12 | 1,35 |



**Cast iron sizzler platter with wood**

Piatto ghisa con vassoio legno  
Gusseisenplatte mit Holzbrett  
Plat en fonte avec planche bois  
Fuente hierro fundido con tabla madera

| art.     | dim. cm. |
|----------|----------|
| 49615-01 | 33,5x22  |



**Cast iron sizzler platter with wood**

Piatto ghisa con vassoio legno  
Gusseisenplatte mit Holzbrett  
Plat en fonte avec planche bois  
Fuente hierro fundido con tabla madera

| art.     | dim. cm. |
|----------|----------|
| 44223S19 | 12,5x19  |





**Mortar and pestle**

Mortaio e pestello  
Mörser und Stößel  
Mortier et pilon  
Mortero y pistilo

| art.     | Ø cm. | h.   | Kg. |
|----------|-------|------|-----|
| 49618-12 | 12,5  | 9,0  | 1,9 |
| 49618-15 | 15,0  | 10,0 | 3,2 |
| 49618-18 | 17,0  | 11,5 | 3,9 |



**Wasabi grater**

Grattugia per wasabi  
Wasabi-Raffel  
Rape à wasabi  
Rallador para wasabi

| art.     | dim. cm. |
|----------|----------|
| 42555-11 | 11x7,5   |



SS

**Oil pourer**

Oliera  
Ölkanne  
Huilière  
Alcuza

| art.     | ml.  |
|----------|------|
| 41780-05 | 500  |
| 41780-07 | 750  |
| 41780-09 | 1000 |



**Wonton noodle skimmer**

Schiumarola Wonton  
Wonton-Sieb  
Ecumoire à Wonton  
Colador para Wonton

| art.     | Ø cm. | h. |
|----------|-------|----|
| 49601-14 | 14    | 13 |

**Stainless steel and natural wood.**  
Inox e legno naturale.



**Chinese kitchen scissors**

Forbici cucina cinesi  
Chinesische Küchenschere  
Ciseaux de cuisine chinois  
Tijeras de cocina china

| art.     | dim. cm. |
|----------|----------|
| 49636-00 | 17x8,5   |

**Stainless steel and brass. –** Inox e ottone.



**Duck fur pincer**

Pinza per anatra  
Ente Fell Zange  
Pince à canard  
Pinza pato

| art.     | l. cm. |
|----------|--------|
| 49637-00 | 15     |



**Fish scaler**

Squamapesce  
Fischentschupper  
Ecailleur à poisson  
Escamador

| art.     | l. cm. |
|----------|--------|
| 49638-00 | 22     |



**Fry basket, coarse mesh**

Schiumarola fritto, rete grossa  
Frittierkorb  
Panier de friture  
Cesta para freír

| art.     | Ø cm. |
|----------|-------|
| 49607-15 | 15,0  |
| 49607-20 | 20,0  |
| 49607-25 | 25,5  |
| 49607-30 | 30,5  |

**Bamboo handle, stainless steel mesh.**  
Manico bamboo, rete inox.



**Fry basket, fine mesh**

Schiumarola fritto, rete fine  
Frittierkorb  
Panier de friture  
Cesta para freír

| art.     | Ø cm. |
|----------|-------|
| 49608-15 | 15,0  |
| 49608-20 | 20,0  |
| 49608-25 | 25,5  |
| 49608-30 | 30,5  |
| 49608-35 | 35,5  |

**Bamboo handle, stainless steel mesh.**  
Manico bamboo, rete inox.



SS

**Skimmer**

Schiumarola  
Schaumlöffel  
Ecumoire  
Espumadera

| art.     | Ø cm. | l. cm. |
|----------|-------|--------|
| 49617-23 | 24    | 45     |
| 49617-25 | 26    | 46     |
| 49617-30 | 30    | 50     |



**Ladle**

Mestolo  
Schöpflöffel  
Louche  
Cacillo

| art.     | Ø cm. |
|----------|-------|
| 49609-12 | 11,8  |
| 49609-14 | 13,8  |

**Stainless steel and natural wood.**  
Inox e legno naturale.



**Spatula**

Paletta  
Teigschäber  
Spatule  
Espátula

| art.     | dim. cm. |
|----------|----------|
| 49610-11 | 11x10,2  |
| 49610-14 | 13,3x12  |

**Stainless steel and natural wood.**  
Inox e legno naturale.



B

**Cooking chopsticks**

Bastoncini per cucinare  
Kochstäbchen  
Baguettes de cuisine  
Palillos para cocinar

| art.     | l. cm. |
|----------|--------|
| 49629-45 | 45     |

**Disposable. – Monouso.**



B

**Wok brush**

Pennello per wok  
Wok-Pinsel  
Pinceaux à wok  
Pincel para wok

| art.     | l. cm. |
|----------|--------|
| 49634-00 | 25,5   |



**Wooden handled wok brush**

Spazzola per wok  
Wok-Bürste, Holzgriff  
Brosse à wok, manche bois  
Cepillo para wok, mango madera

| art.     | l. cm. |
|----------|--------|
| 49635-00 | 27,5   |



# PIZZA

ETHNIC CUISINE  
CUCINA ETNICA







SS

**Oil pourer**

Oliera  
Ölkanne  
Huilière  
Alcuza

| art.     | lt.  |
|----------|------|
| 41780-05 | 0,50 |
| 41780-07 | 0,75 |
| 41780-09 | 1,00 |



**Oil pourer, copper**

Oliera, rame  
Ölkanne, Kupfer  
Huilière, cuivre  
Alcuza, cobre

| art.     | h. cm. | lt.  |
|----------|--------|------|
| 41781-05 | 23,0   | 0,50 |
| 41781-10 | 27,0   | 1,00 |
| 41781-15 | 31,5   | 1,50 |

Tinned inside. – Interno stagnato.

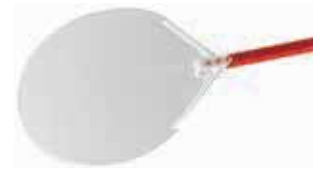

**Pizza peel, aluminum**

Pala pizza, alluminio  
Pizzaschaufel, Aluminum  
Pelle à pizza, aluminum  
Pala pizza, aluminio

| art.     | Ø cm. | l. cm. | gr.  |
|----------|-------|--------|------|
| 11701-02 | 32    | 150    | 736  |
| 11701-06 | 37    | 150    | 870  |
| 11701-10 | 41    | 150    | 1226 |
| 11701-13 | 45    | 150    | 1460 |
| 11701-16 | 50    | 150    | 1604 |



**Pizza peel, aluminum**

Pala pizza, alluminio  
Pizzaschaufel, Aluminum  
Pelle à pizza, aluminum  
Pala pizza, aluminio

| art.     | cm.   | l. cm. | gr.  |
|----------|-------|--------|------|
| 11702-02 | 32x32 | 150    | 784  |
| 11702-06 | 37x37 | 150    | 894  |
| 11702-10 | 41x41 | 150    | 1246 |
| 11702-16 | 50x50 | 150    | 1694 |



**Perforated pizza peel, aluminum**

Pala pizza forata, alluminio  
Pizzaschaufel, gelocht, Aluminum  
Pelle à pizza perforée, aluminum  
Pala pizza perforada, aluminio

| art.     | cm.   | l. cm. | gr.  |
|----------|-------|--------|------|
| 11704-02 | 32x32 | 150    | 700  |
| 11704-06 | 37x37 | 150    | 816  |
| 11704-13 | 45x45 | 150    | 1250 |
| 11704-16 | 50x50 | 150    | 1409 |



SS

**Pizza peel, small**

Palettino  
Pizzaschaufel, klein  
Petite pelle à pizza  
Pala pizza, pequeña

| art.     | Ø cm. | l. cm. | gr. |
|----------|-------|--------|-----|
| 11705-02 | 17    | 150    | 780 |
| 11705-06 | 20    | 150    | 846 |
| 11705-10 | 23    | 150    | 938 |
| 11705-14 | 26    | 150    | 984 |



SS

**Perforated pizza peel, small**

Palettino forato  
Pizzaschaufel, gelocht, klein  
Petite pelle à pizza perforée  
Pala pizza perforada, pequeña

| art.     | Ø cm. | l. cm. | gr. |
|----------|-------|--------|-----|
| 11706-02 | 17    | 150    | 770 |
| 11706-06 | 20    | 150    | 830 |
| 11706-10 | 23    | 150    | 912 |
| 11706-14 | 26    | 150    | 954 |



**Oven pizza peel, aluminum**

Pala per infornare, alluminio  
Back-Pizzaschaufel, Aluminum  
Pelle à enfourner, aluminum  
Pala para hornear, aluminio

| art.     | cm.   | l. cm. | gr.  |
|----------|-------|--------|------|
| 41765-32 | 32x32 | 150    | 1200 |
| 41765-37 | 37x37 | 150    | 1400 |
| 41765-41 | 41x41 | 150    | 1500 |
| 41765-45 | 45x45 | 150    | 1600 |
| 41765-50 | 50x50 | 150    | 1700 |



SS

**Oven pizza peel**

Pala per infornare  
Back-Pizzaschaufel  
Pelle à enfourner  
Pala para hornear

| art.     | Ø cm. | l. cm. | gr. |
|----------|-------|--------|-----|
| 41735-29 | 29    | 150    | 870 |

Aluminum handle. – Manico alluminio.



**Oven pizza peel, aluminum**  
Pala per infornare, alluminio  
Back-Pizzaschaufel, Aluminium  
Pelle à enfourner, aluminium  
Pala para hornear, aluminio

| art.     | cm.   | l. cm. | gr. |
|----------|-------|--------|-----|
| 41736-32 | 32x30 | 150    | 954 |



**Perforated pizza peel, small**  
Palettino forato  
Pizzaschaufel, gelocht, klein  
Petite pelle à pizza perforée  
Pala pizza perforada, pequeña

| art.     | Ø cm. | l. cm. | gr. |
|----------|-------|--------|-----|
| 41737-17 | 17    | 150    | 890 |
| 41737-20 | 20    | 150    | 910 |
| 41737-23 | 23    | 150    | 960 |

SS



**Pizza peel, small**  
Palettino  
Pizzaschaufel, klein  
Petite pelle à pizza  
Pala pizza, pequeña

| art.     | Ø cm. | l. cm. | gr.  |
|----------|-------|--------|------|
| 41738-17 | 17    | 150    | 905  |
| 41738-20 | 20    | 150    | 975  |
| 41738-23 | 23    | 150    | 1030 |

SS



**Pizza peel, small, aluminum**  
Palettino, alluminio  
Pizzaschaufel, klein, Aluminium  
Petite pelle à pizza, aluminium  
Pala pizza, pequeña, aluminio

| art.     | Ø cm. | l. cm. | gr. |
|----------|-------|--------|-----|
| 41735-20 | 20    | 150    | 800 |



**Pizza peel**  
Pala pizza  
Pizzaschaufel  
Pelle à enfourner  
Pala pizza

| art.     | Ø cm. | l. cm. |
|----------|-------|--------|
| 41764-28 | 28    | 125    |
| 41764-33 | 33    | 200    |
| 41764-40 | 40    | 200    |

W



**Ash shovel**  
Paletta cenere  
Asche-Schaufel  
Pelle à cendres  
Paleta recogedar cenizas

| art.     | cm.   | l. cm. |
|----------|-------|--------|
| 41768-21 | 21x31 | 173    |

SS



**Rake**  
Rastrello  
Harke  
Râteau  
Rastrillo

| art.     | cm.   | l. cm. |
|----------|-------|--------|
| 41768-22 | 24x10 | 150    |

SS



**Adjustable brush**  
Spazzola orientabile  
Drehbare Bürste  
Brosse orientable  
Cepillo orientable

| art.     | cm.    | l. cm. |
|----------|--------|--------|
| 41767-20 | 20x6,5 | 155    |

Brass bristles. – Setole ottone.



**Adjustable brush**  
Spazzola orientabile  
Drehbare Bürste  
Brosse orientable  
Cepillo orientable

| art.     | cm.  | l. cm. |
|----------|------|--------|
| 41766-27 | 27x7 | 150    |

Brass bristles. – Setole ottone.



**Adjustable brush**  
Spazzola orientabile  
Drehbare Bürste  
Brosse orientable  
Cepillo orientable

| art.     | cm.  | l. cm. |
|----------|------|--------|
| 41766-16 | 16x5 | 150    |

Brass bristles. – Setole ottone.



**Adjustable brush**  
Spazzola orientabile  
Drehbare Bürste  
Brosse orientable  
Cepillo orientable

| art.     | cm.  | l. cm. |
|----------|------|--------|
| 41766-14 | 14x7 | 150    |



**Adjustable brush**  
Spazzola orientabile  
Drehbare Bürste  
Brosse orientable  
Cepillo orientable

| art.     | cm.    | l. cm. |
|----------|--------|--------|
| 41739-20 | 20x6,6 | 150    |



**Brush for grill cleaning**

Spazzola per griglia, setole in acciaio  
Grillenbürste mit Stahlborsten  
Brosser pour grille avec soies en acier  
Cepillo para parrilla con cerdas de acero

art. cm.  
41740-00 27x4x15



SS

**Support for peels**

Poggia pala pizza  
Schaufelträger  
Support pour pelles à pizza  
Portapala para palas

art. cm. Kg.  
41769-36 41x16x39 3,0  
41769-50 53x16x39 3,5



**Small pizza peel wall rack, aluminum**

Portapaleto da muro, alluminio  
Pizzaschaufel-Wandgestell, Aluminum  
Support mural petite pelle, aluminum  
Soporte mural de pala pizza, aluminio

art.  
41769-02



**Pizza peel wall rack, aluminum**

Appendi pala da muro, alluminio  
Pizzaschaufel-Wandgestell, Aluminum  
Support mural pour pelle, aluminum  
Soporte mural de pala pizza, aluminio

art.  
41769-01



**Double-sided brush**

Spazzola bi-facciale  
Bürste Deidseitig  
Brosse double face  
Cepillo doble

art. l. cm.  
41761-02 100



SS

**Pizza peel rack**

Porta pale  
Ständer für Schaufeln  
Support pour pelles  
Soporte para pala

art. h. cm. Kg.  
41769-00 172 14



SS

**Pizza peel, marble base**

Porta pale, base marmo  
Ständer für Schaufeln  
Support pour pelles  
Soporte para pala

art. cm.  
41769G00 25x35x180

Supplied WITHOUT peels. – Fornito SENZA pale.



**Adjustable brush**

Spazzola orientabile  
Drehbare Bürste  
Brosse orientable  
Cepillo orientable

art. cm. l. cm.  
41767G20 20x6 160

Brass bristles. – Setole ottone.



**Pizza peel, aluminum**

Pala pizza, alluminio  
Pizzaschaufel, Aluminum  
Pelle à pizza, aluminum  
Pala pizza, aluminio

art. cm. l. cm.  
41704G33 33x33 150  
41704G36 36x36 150



SS

**Perforated pizza peel, small**

Palettino forato  
Pizzaschaufel, gelocht, klein  
Petite pelle à pizza perforée  
Pala pizza perforada, pequeña

| art.     | Ø cm. | l. cm. |
|----------|-------|--------|
| 41737G20 | 20    | 150    |
| 41737G23 | 23    | 150    |



SS

**Pan gripper**

Pinza per teglie  
Pizzablech-Zange  
Pince à plaques  
Pinza fuente horns

| art.     | l. cm. |
|----------|--------|
| 42822-00 | 23     |



SS

**Pan gripper**

Pinza per teglie  
Pizzablech-Zange  
Pince à plaques  
Pinza fuente horns

| art.     | l. cm. |
|----------|--------|
| 18323-00 | 23     |



SS

**Pizza cutter**

Tronchetto tagliapizza  
Pizzaschneider  
Coupe-pizza  
Cortador de pizza

| art.     | Ø cm. | l. cm. |
|----------|-------|--------|
| 18324-00 | 13,5  | 19     |



SS

**Divisible pizza scissors**

Forbice pizza smontabile  
Pizzaschere, teilbar  
Ciseaux à pizza, divisible  
Tijeras para pizza desmontables

| art.     | l. cm. |
|----------|--------|
| 18276-00 | 25     |



SS

**Pizza wheel**

Rotella taglia pizza  
Pizzaschneider  
Roulette à pizza  
Ruleta cortapizzas

| art.     | Ø cm. |
|----------|-------|
| 18324-10 | 10    |



SS

**Pizza knife**

Coltello per pizzaiolo  
Pizzamesser  
Couteau à pizza  
Cuchillo para pizza

| art.     | l. cm. |
|----------|--------|
| 48280-45 | 23     |



SS

**Farinata knife**

Coltello per farinata  
Farinata Messer  
Couteau à farinata  
Cuchillo farinata

| art.     | l. cm. |
|----------|--------|
| 42830-08 | 8      |



SS

**Perforated spatula**

Paletta triangolare, forata  
Palette, gelocht  
Palette perforée  
Pala triangular perforada

| art.     | cm.   |
|----------|-------|
| 18301-01 | 12x15 |



SS

**Spatula**

Paletta triangolare  
Palette  
Palette  
Pala triangular

| art.     | cm.   |
|----------|-------|
| 18301-02 | 12x15 |



**Peel with handle, aluminum**

Pala manicata, alluminio  
Schaufel mit Griff, Aluminum  
Pelle avec manche, alu  
Pala con mango, aluminio

| art.     | Ø cm. |
|----------|-------|
| 42826-32 | 32    |
| 42826-37 | 37    |



SS

**Perforated peel with handle**

Pala manicata, forata  
Schaufel mit Griff, gelocht  
Pelle perforée avec manche  
Pala con mango, perforada

| art.     | cm.   |
|----------|-------|
| 18302-01 | 22x18 |



SS

**Peel with handle**  
Pala manicata  
Schaufel mit Griff  
Pelle avec manche  
Pala con mango

| art.     | cm.   |
|----------|-------|
| 18302-02 | 22x18 |



W

**Round platter**  
Vassoio rotondo  
Buchenholzbrett, rund  
Plateau rond  
Bandeja redonda

| art.     | Ø cm. | h. cm. |
|----------|-------|--------|
| 41774-33 | 33    | 1,2    |

Beech wood. – Faggio.



W

**Cutting board 1 portion**  
Tagliere monoporzione  
Einzelportion Tablett  
Planche mono-portion  
Tabla monoporción

| art.     | cm.       |
|----------|-----------|
| 41775-34 | 34x20x1,2 |

Beech wood. – Faggio.



MF

**Round platter**  
Vassoio rotondo  
Tablett, rund  
Plateau rond  
Bandeja redonda

| art.     | Ø cm. | h. mm. |
|----------|-------|--------|
| 44473-02 | 33    | 0,8    |
| 44473-03 | 43    | 0,8    |



W

**Round platter**  
Tagliere rotondo  
Holzbrett, rund  
Plateau rond  
Tabla redonda

| art.     | cm.       |
|----------|-----------|
| 44260-30 | 30x43x1,8 |
| 44260-34 | 34x47x1,8 |

Iroko wood. – Iroko.



W

**Pizza plate with wooden platter**  
Piatto pizza con tagliere legno  
Pizzaplatte mit Holzbrett  
Plat à pizza avec planche bois  
Fuente pizza con tabla madera

| art.     | Ø cm. |
|----------|-------|
| 44233-16 | 16    |
| 44233-20 | 20    |

Cups not included. – Ciotoline non incluse.



W

**Pizza plate with wooden platter**  
Piatto pizza con tagliere legno  
Pizzaplatte mit Holzbrett  
Plat à pizza avec planche bois  
Fuente pizza con tabla madera

| art.     | Ø cm. |
|----------|-------|
| 44232S12 | 12    |
| 44232S16 | 16    |
| 44232S20 | 20    |

Enamelled cast iron plate. – Piatto in ghisa smaltata.

**PIZZA SYSTEM**

The modular system where the base and lid are the same element. Rotation system allows the steam of hot pizzas to escape.

Sistema modulare, la base e coperchio sono lo stesso elemento. Dotato di sistema rotabile, per la fuoriuscita del vapore delle pizze calde.



**Base and lid**  
Base e coperchio  
Basis und Abdeckung  
Base et couvercle  
Base y tapa

| art.     | cm.       |
|----------|-----------|
| 44975-35 | 41x41x7,5 |
| 44975-50 | 57x57x9,5 |



**Extender**  
Estensore  
Aufsatz  
Réhausse  
Extensión

| art.     | cm.       |
|----------|-----------|
| 44975H35 | 41x41x7,5 |
| 44975H50 | 57x57x9,5 |



**Insulated container**  
Contentore isothermico  
Thermobehälter  
Conteneur isotherme  
Contenedor isotérmico

| art.     | cm.        | lt. |
|----------|------------|-----|
| 44961-03 | 42x42x34,5 | 36  |

**With steam release system. For pizza boxes max 36x36 cm.** – Con sistema di rilascio del vapore. Per cartoni pizza max 36x36 cm.



**Insulated container with handle**  
Contentore isothermico con maniglia  
Thermobehälter mit Grill  
Conteneur isotherme avec manche  
Contenedor isotérmico con asa

| art.     | cm.        | lt. |
|----------|------------|-----|
| 44961M03 | 42x42x34,5 | 36  |



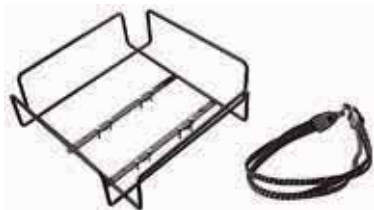

NEW

**Bike basket rack + elastic hook**

Cestello portapacco bike + gancio elastico  
Fahrradträgerkorb + elastischer Haken  
Porte-panier pour vélos + crochet élastique  
Canasta para bicicletas + gancho elástico

art. cm.  
44962-01 46x46x16

**With 8 self-locking screws. Max platform capacity 25 kg.** – Completo di 8 viti autobloccanti. Portata massima pianale 25 kg.



NEW

**Pizza delivery bag**

Borsa isotermitica  
Thermo-Tasche  
Sac thermique  
Bolsa térmica

art. cm. cap.  
44960-01 55x50x20 3xø45



**Pizza delivery bag**

Borsa isotermitica  
Thermo-Tasche  
Sac thermique  
Bolsa térmica

art. cm. cap.  
44960-04 46x44x20 4xø30



NEW

**Pizza delivery bag**

Borsa isotermitica  
Thermo-Tasche  
Sac thermique  
Bolsa térmica

art. cm. cap.  
44960-06 34x34x19 5xø33  
44960-07 42x42x19 4xø40



NEW

**Pizza delivery bag**

Borsa isotermitica  
Thermo-Tasche  
Sac thermique  
Bolsa térmica

art. cm. cap.  
44960-02 46x46x12 2xø40  
44960-03 50x51x11 2xø45



NEW

**Sandwich delivery bag**

Borsa isotermitica  
Thermo-Tasche  
Sac thermique  
Bolsa térmica

art. cm.  
44960-13 39x27x30



NEW

**Pizza delivery bag**

Borsa isotermitica  
Thermo-Tasche  
Sac thermique  
Bolsa térmica

art. cm.  
44960-10 51x46x41



NEW

**Pizza delivery bag**

Borsa isotermitica  
Thermo-Tasche  
Sac thermique  
Bolsa térmica

art. cm.  
44960-11 48x48x70



**NEW**

**Pizza delivery bag with rack**  
Borsa isoterma con rastrelliera  
Thermo-Tasche mit Gestell  
Sac thermique avec étagère  
Bolsa térmica con rack

art. cm. cap.  
44960K10 51x46x41 6xø45



**NEW**

**Pizza delivery bag with rack**  
Borsa isoterma con rastrelliera  
Thermo-Tasche mit Gestell  
Sac thermique avec étagère  
Bolsa térmica con rack

art. cm. cap.  
44960K11 48x48x70 10xø45



**NEW**

**Pizza delivery backpack**  
Zaino isoterma  
Thermo-Rucksack  
Sac à dos thermique  
Mochila térmica

art. cm.  
44962-05 45x45x38

**Polyester and nylon. With inner PP insulaed container. For pizza boxes up to 35x35 cm. – Poliestere e nylon. Interno con contenitore isoterma in PP. Per scatole pizza fino a 35x35 cm.**



**PP**  
**SS**

**Dough scraper, flexible**  
Tagliapasta flessibile  
Abstecher, flexibile  
Raclette flexible  
Cortapastas flexible

art. cm.  
18501-02 12x9,5



**PP**  
**SS**

**Dough scraper**  
Tagliapasta  
Abstecher  
Raclette  
Cortapastas

art. cm.  
18501-01 12x16  
18501-03 13,5x10  
18501-04 12x9,5



**PP**  
**SS**

**Dough scraper**  
Raschia  
Teigschäber  
Raclette  
Rasqueta

art. cm.  
18501-05 11x19,5





PP  
SS

**Dough scraper**

Raschia  
Teigschäber  
Raclette  
Rasqueta

art. cm.  
18502-18 18x9



PP  
SS

**Dough scraper**

Raschia  
Teigschäber  
Raclette  
Rasqueta

art. cm.  
18503-12 12x10



PP  
SS

**Dough scraper**

Raschia  
Teigschäber  
Raclette  
Rasqueta

art. cm.  
18504-15 15x7,5



PP  
SS

**Dough scraper**

Raschia  
Teigschäber  
Raclette  
Rasqueta

art. cm.  
18520-15 15x6



PA+  
plus

**Pizza ladle, flat bottom**

Mestolo pizza, fondo piatto  
Schöpflöffel, flachboden  
Louche fond plat  
Cacillo fondo plano

art. Ø cm. l. cm.  
12968-10 10 27



PS

**Dough cutter**

Tagliapasta  
Teigschäber  
Raclette  
Rascador

art. cm.  
47621-11 10x24

**Shock and scratchproof material. Do not use on heat sources.** – Materiale antiurto e antigraffio. Non usare su fonti di calore.



PS

**Dough cutter**

Tagliapasta  
Teigschäber  
Raclette  
Rascador

art. cm.  
47621-12 13,5x14,5

**Shock and scratchproof material. Do not use on heat sources.** – Materiale antiurto e antigraffio. Non usare su fonti di calore.



PE

**Dough box**

Contenitore per impasti  
Behälter für Pizzateig  
Récipient à pétrissage  
Contenedor para masa de pizza

art. cm. lt.  
41762-07 60x40x7,5 14  
41762-09 60x40x9,5 19  
41762-13 60x40x13 26



PE

**Cover for dough box**

Coperchio per contenitore  
Deckel für Pizzateig-Behälter  
Couvercle pour récipient à pétrissage  
Tapa para contenedor

art. cm.  
41763-00 60x40

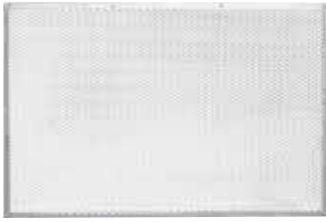

**Pizza screen, aluminum**  
Retina pizza, alluminio  
Pizzanetzscheibe, Aluminum  
Toile à pizza, aluminium  
Red para pizza, aluminio

| art.     | cm.   |
|----------|-------|
| 41734-60 | 60x40 |



**Pizza screen, aluminum**  
Retina pizza, alluminio  
Pizzanetzscheibe, Aluminum  
Toile à pizza, aluminium  
Red para pizza, aluminio

| art.     | Ø cm. |
|----------|-------|
| 41727-28 | 28    |
| 41727-30 | 30    |
| 41727-33 | 33    |
| 41727-36 | 36    |
| 41727-40 | 40    |

**Without seam. – Senza giunzione.**



**Pizza screen, aluminum**  
Retina pizza, alluminio  
Pizzanetzscheibe, Aluminum  
Toile à pizza, aluminium  
Red para pizza, aluminio

| art.     | Ø cm. |
|----------|-------|
| 41727-45 | 45    |
| 41727-50 | 50    |
| 41727-55 | 55    |
| 41727-60 | 60    |

**Without seam. – Senza giunzione.**



**SS**

**Pizza screen rack**  
Rastrelliera per retine  
Pizzanetzscheiben-Träger  
Etagère à toiles  
Rack para red para pizza

| art.     | cm.     |
|----------|---------|
| 41771-96 | 23x35,6 |

**Suitable for 96 screens. – Può contenere 96 retine.**



**SS**

**Pizza pan rack**  
Rastelliera per teglie pizza  
Pizzableche-Träger  
Etagère pour plaques à pizza  
Rack para placas pizza

| art.     | cm.          |
|----------|--------------|
| 41770-15 | 30,5x30,5x70 |

**Rails h.3,5 cm. for sheets up to Ø 36 cm.**  
Distanza piani cm 3,5, per teglie max ø 36 cm.



**Baking tray, alusteel**  
Teglia forno, acciaio alluminato  
Backblech mit Aluminiumüberzug  
Plaque à pizza, tôle aluminée  
Placa pizza, acero aluminizado

| art.     | Ø cm. | h. cm. | U. Pack |
|----------|-------|--------|---------|
| 11739-20 | 20    | 2,5    | 10      |
| 11739-24 | 24    | 2,5    | 10      |
| 11739-28 | 28    | 2,5    | 10      |
| 11739-32 | 32    | 2,5    | 10      |



**Pizza pan, heavy blue steel**  
Teglia pizza, ferro blu pesante  
Pizzablech, Blaublech, Schwerausführung  
Plaque à pizza, tôle forte bleuie  
Placa pizza, hierro pesante

| art.     | Ø cm. | h. cm. | U. Pack |
|----------|-------|--------|---------|
| 11744-20 | 20    | 2,5    | 10      |
| 11744-24 | 24    | 2,5    | 10      |
| 11744-28 | 28    | 2,5    | 10      |
| 11744-32 | 32    | 2,5    | 10      |



**Pizza pan, perforated, non stick coated**  
Teglia pizza forata, antiaderente  
Pizzablech, gelocht, beschichtet  
Plaque à pizza perforée, anti-adhésive  
Placa pizza perforada, antiadherente

| art.     | Ø cm. | h. cm. |
|----------|-------|--------|
| 41729-30 | 30    | 1,3    |
| 41729-34 | 34    | 1,3    |



**Pizza pan double non stick-coating**  
Teglia pizza, antiaderente a 2 strati  
Pizzablech mit Doppel-Beschichtung  
Plaque à pizza, double revêtement  
Placa pizza antiadherente, 2 capas

| art.     | Ø cm. | h. cm. | U. Pack |
|----------|-------|--------|---------|
| 11741-20 | 20    | 2,5    | 5       |
| 11741-24 | 24    | 2,5    | 5       |
| 11741-26 | 26    | 2,5    | 5       |
| 11741-28 | 28    | 2,5    | 5       |
| 11741-32 | 32    | 2,5    | 5       |

**Heat resistant up to 280°C. – Resistente a 280 °C.**



**Pizza pan, blue steel**  
Teglia pizza, ferro blu  
Pizza-Blaublech  
Plaque à pizza, tôle bleuie  
Placa pizza, hierro

| art.     | Ø cm. | h. cm. | U. Pack |
|----------|-------|--------|---------|
| 11740-14 | 14    | 2,5    | 5       |
| 11740-16 | 16    | 2,5    | 5       |
| 11740-18 | 18    | 2,5    | 5       |
| 11740-20 | 20    | 2,5    | 5       |
| 11740-22 | 22    | 2,5    | 5       |
| 11740-24 | 24    | 2,5    | 5       |



**Pizza pan, blue steel**  
Teglia pizza, ferro blu  
Pizza-Blaublech  
Plaque à pizza, tôle bleuie  
Placa pizza, hierro

| art.     | Ø cm. | h. cm. | U. Pack |
|----------|-------|--------|---------|
| 11740-26 | 26    | 2,5    | 5       |
| 11740-28 | 28    | 2,5    | 5       |
| 11740-30 | 30    | 2,5    | 5       |
| 11740-32 | 32    | 2,5    | 5       |
| 11740-36 | 36    | 2,5    | 5       |
| 11740-40 | 40    | 2,5    | 5       |



**Pizza pan, blue steel**  
Teglia pizza, ferro blu  
Pizza-Blaublech  
Plaque à pizza, tôle bleuie  
Placa pizza, hierro

| art.     | Ø cm. | h. cm. | U. Pack |
|----------|-------|--------|---------|
| 11742-16 | 16    | 3,5    | 10      |
| 11742-18 | 18    | 3,5    | 10      |
| 11742-20 | 20    | 3,5    | 10      |
| 11742-22 | 22    | 3,5    | 10      |
| 11742-24 | 24    | 3,5    | 10      |
| 11742-26 | 26    | 3,5    | 10      |
| 11742-28 | 28    | 3,5    | 10      |



**Pizza pan, blue steel**  
Teglia pizza, ferro blu  
Pizza-Blaublech  
Plaque à pizza, tôle bleuie  
Placa pizza, hierro

| art.     | Ø cm. | h. cm. | U. Pack |
|----------|-------|--------|---------|
| 11742-30 | 30    | 3,5    | 10      |
| 11742-32 | 32    | 3,5    | 5       |
| 11742-36 | 36    | 3,5    | 5       |
| 11742-40 | 40    | 3,5    | 5       |
| 11742-45 | 45    | 4,0    | 5       |
| 11742-50 | 50    | 4,0    | 5       |
| 11742-60 | 60    | 4,0    | 5       |



**Baking tray, blue steel, rectangular**  
Teglia rettangolare, ferro blu  
Blaublech, rechteckig  
Plaque rectangulaire, tôle bleuie  
Placa rectangular, hierro

| art.     | cm.   | h. cm. |
|----------|-------|--------|
| 41745-30 | 30x23 | 3      |
| 41745-35 | 35x28 | 3      |
| 41745-40 | 40x30 | 3      |
| 41745-50 | 50x35 | 3      |
| 41745-60 | 60x40 | 3      |
| 41745-65 | 65x45 | 3      |



**Baking tray, alusteel**  
Teglia, alluminata  
Backblech, Aluminumüberzug  
Plaque rectangulaire, tôle aluminitée  
Placa rectangular, acero aluminizado

| art.     | cm.   | h. cm. |
|----------|-------|--------|
| 41746-60 | 60x40 | 2      |





**Baking tray, alusteel**

Teglia, alluminata  
Backblech, Aluminiumüberzug  
Plaque rectangulaire, tôle aluminitée  
Placa rectangular, acero aluminizado

| art.     | cm.   | h. cm. |
|----------|-------|--------|
| 41751-30 | 30x23 | 3      |
| 41751-35 | 35x28 | 3      |
| 41751-40 | 40x30 | 3      |
| 41751-50 | 50x35 | 3      |
| 41751-60 | 60x40 | 3      |
| 41751-65 | 65x45 | 3      |



**Baking tray, aluminum**

Teglia, alluminio  
Backblech, Aluminium  
Plaque à cuisson, aluminium  
Placa pastelería, aluminio

| art.     | cm.     | GN  | h. cm. |
|----------|---------|-----|--------|
| 41744-32 | 32,5x53 | 1/1 | 1      |
| 41744-53 | 53x65   | 2/1 | 1      |
| 41744-60 | 60x40   | -   | 1      |



**Baking tray, aluminum, perforated**

Teglia forata, alluminio  
Backblech, gelocht, Aluminium  
Plaque perforée, aluminium  
Placa perforada, aluminio

| art.     | cm.     | h. cm. |
|----------|---------|--------|
| 41756-30 | 30x40   | 1      |
| 41756-32 | 32,5x53 | 1      |
| 41756-53 | 53x65   | 1      |
| 41756-60 | 60x40   | 1      |



**Baking tray, non stick coated**

Teglia antiaderente  
Blech mit Antihftbeschichtung  
Plaque avec revêtement anti-adhésif  
Placa antiaderente

| art.     | cm.   | h. cm. |
|----------|-------|--------|
| 41747-60 | 60x40 | 2      |



**Baking tray, non stick coated**

Teglia antiaderente  
Blech mit Antihftbeschichtung  
Plaque avec revêtement anti-adhésif  
Placa antiaderente

| art.     | Ø cm. | GN  | pcs/pz |
|----------|-------|-----|--------|
| 41755-11 | 12,5  | 1/1 | 6      |



**Baking tray, non stick coated**

Teglia antiaderente  
Blech mit Antihftbeschichtung  
Plaque avec revêtement anti-adhésif  
Placa antiaderente

| art.     | cm.     | GN  | h. cm. |
|----------|---------|-----|--------|
| 41743-32 | 32,5x53 | 1/1 | 1      |
| 41743-53 | 53x65   | 2/1 | 1      |
| 41743-60 | 60x40   | -   | 1      |



**Baking tray, perforated, non stick coated**

Teglia forata, antiaderente  
Blech, gelocht mit Antihftbeschichtung  
Plaque perforée, revêtement anti-adhésif  
Placa perforada, antiaderente

| art.     | cm.     | GN  | h. cm. |
|----------|---------|-----|--------|
| 41753-30 | 30x40   | -   | 1      |
| 41753-32 | 32,5x53 | 1/1 | 1      |
| 41753-53 | 53x65   | 2/1 | 1      |
| 41753-60 | 60x40   | -   | 1      |



**Baking tray, alusteel**

Teglia, alluminata  
Backblech, Aluminiumüberzug  
Plaque, tôle aluminitée  
Placa, acero aluminizado

| art.     | Ø cm. | cm.   | pcs/pz |
|----------|-------|-------|--------|
| 41752-08 | 14    | 60x40 | 8      |
| 41752-12 | 12    | 60x40 | 12     |
| 41752-24 | 12    | 60x80 | 24     |



# COFFEE SHOP CAFFETTERIA

BAR HAPPY HOUR





**Nitro Whip**  
Sifone nitro  
Nitrobereiter  
Siphon à nitro  
Sifón para Nitro

| art.     | lt. | des.                  |
|----------|-----|-----------------------|
| 41452N10 | 1   | Whip/Sifone           |
| 41452N16 | -   | 16 chargers/ricariche |

**Nitro Brew is on one of the fastest growing trends in the coffee business. Offer Nitro Coffee, Nitro Tea, and Nitro Cocktails to delight your guests table/barside. Adding Nitrogen (N2) to cold brew coffee and cocktails initiates a spectacular cascading effect, making the beverage unique, attractive, and personal. Nitrogen creates a velvety creamy texture and a long lasting foamy head for brews and cocktails.** – Infusi Nitro è una delle tendenze in rapida crescita nel settore del caffè. Offri Nitro Caffè, Nitro Te e Nitro Cocktails per deliziare i tuoi ospiti. Aggiungendo l'azoto (N2) per preparare caffè e cocktail a freddo, viene avviato uno spettacolare effetto a cascata, rendendo la bevanda unica, attraente e personale. L'azoto crea una consistenza vellutata e cremosa e una spuma di lunga durata per infusi e cocktail.

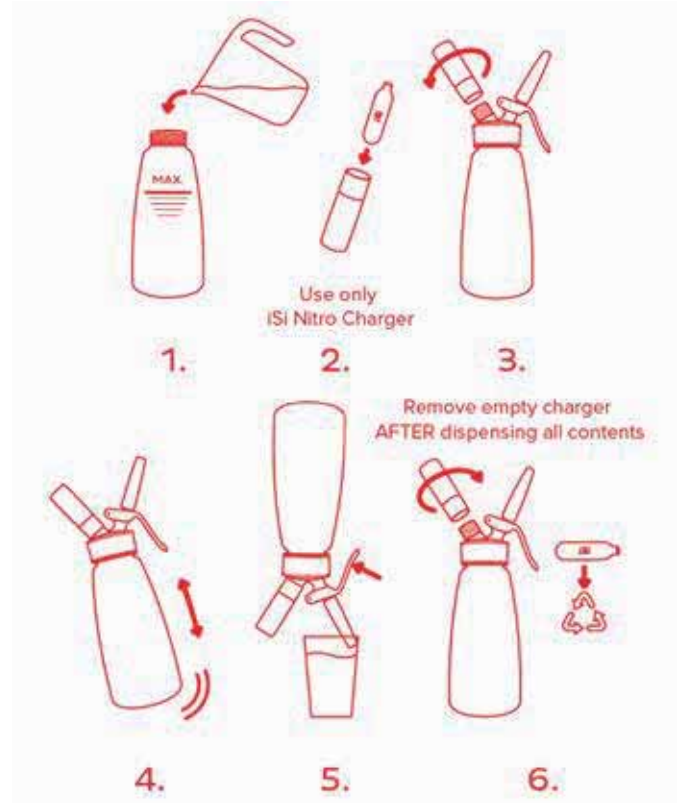

**Set of 10 stencils, plastic**  
Kit 10 mascherine, plastica  
Satz 10 Masken, kunststoff  
Set 10 pcs masques, plastique  
Juego 10 máscaras, plástico

| art.     | Ø cm. | h. cm. | lt.  |
|----------|-------|--------|------|
| 47859-01 | 10    | 16     | 0,25 |



**Set of 10 stencils, plastic**  
Kit 10 mascherine, plastica  
Satz 10 Masken, kunststoff  
Set 10 pcs masques, plastique  
Juego 10 máscaras, plástico

| art.     | Ø cm. |
|----------|-------|
| 47859-02 | 10    |



**Set of 4 stencils, plastic**  
Kit 4 mascherine, plastica  
Satz 4 Masken, kunststoff  
Set 4 pcs masques, plastique  
Juego 4 máscaras, plástico

| art.     | Ø cm. |
|----------|-------|
| 47859-03 | 10    |



SS

**Cocoa duster kit**  
Kit spargicacao  
Kakaostreuer-Set  
Set glacière à cacao  
Juego dosificador cacao

| art.     | Ø cm. | h. cm. |
|----------|-------|--------|
| 42923-07 | 6,5   | 13     |



SS

**Cocoa dredger**  
Spargicacao  
Kakaostreuer  
Saupoudreuse  
Especiero

| art.     | Ø cm. | h. cm. | ml. |
|----------|-------|--------|-----|
| 41607-00 | 5,5   | 7,5    | 160 |



SS

**Sugar pourer**  
Spargizucchero  
Zuckerstreuer  
Saupoudreuse  
Especiero

| art.     | Ø cm. | Ø mm. | ml. |
|----------|-------|-------|-----|
| 47023-01 | 7     | 1,5   | 300 |
| 47023-02 | 7     | 2,5   | 300 |
| 47023-03 | 7     | 5     | 300 |
| 47023-04 | 7     | mesh  | 300 |



SS

**Sugar pourer**  
Spargizucchero  
Zuckerstreuer  
Sucrier  
Dispensador azúcar

| art.     | Ø cm. | h. cm. | ml. |
|----------|-------|--------|-----|
| 41525-01 | 8     | 15     | 250 |



SS

**Sugar pourer**  
Spargizucchero  
Zuckerstreuer  
Sucrier  
Dispensador azúcar

| art.     | Ø cm. | h. cm. | ml. |
|----------|-------|--------|-----|
| 42920-02 | 7,5   | 13,5   | 320 |



SS

**Sugar pourer**  
Spargizucchero  
Zuckerstreuer  
Sucrier  
Dispensador azúcar

| art.     | Ø cm. | h. cm. | ml. |
|----------|-------|--------|-----|
| 41645-00 | 7,5   | 17     | 320 |



SS

**Honey/cream dispenser**  
Dosatore miele/cremiera  
Sahne-/Honigkännchen  
Doseur pour miel/lait  
Dosificador para miel/leche

| art.     | Ø cm. | h. cm. | ml. |
|----------|-------|--------|-----|
| 41525-00 | 8,5   | 13,5   | 300 |

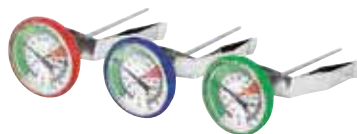

NEW

SS

**Milk frothing thermometers, 3 pcs**  
Termometri latte/barista, 3 pz  
Termometri latte/barista, 3 pz  
Mich-Thermometer, 3 Stk  
Thermomètres à lait, 3 pièces  
Termómetros leche, 3 pz

| art.     | Ø cm. | scala | range     |
|----------|-------|-------|-----------|
| 49709-03 | 4,5   | 1°C   | -10+110°C |

Red, green and blue, to easily identify different types of milk used, to avoid cross-contamination. Stem 175 mm. – Rosso, verde e blu, per identificare facilmente i diversi tipi di latte utilizzati, per evitare la contaminazione incrociata. Stelo 175 mm.

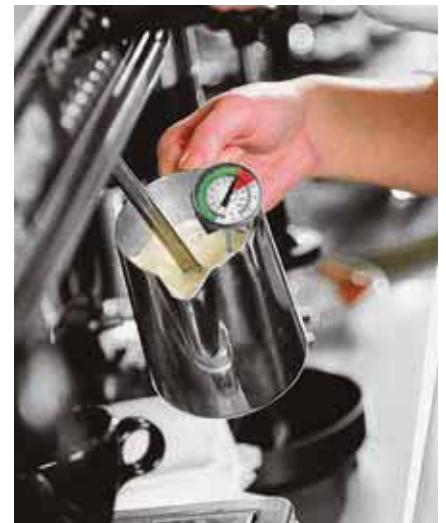



SS

**Milk pot with lid**

Lattiera con coperchio  
Milchgießer mit Deckel  
Pot à lait avec couvercle  
Jarra leche con tapa

| art.     | lt.  |
|----------|------|
| 66303-01 | 0,15 |
| 66303-03 | 0,30 |
| 66303-06 | 0,60 |



SS

**Cappuccino milk pot**

Lattiera cappuccino  
Capuccino-Milchkanne  
Pot à cappuccino  
Jarra cappuccino

| art.     | lt. |
|----------|-----|
| 66307-06 | 0,6 |
| 66307-09 | 0,9 |
| 66307-12 | 1,2 |



SS

**Spoon holder**

Porta cucchiaini  
Kaffeelöffelbehälter  
Porte cuillères  
Porta cucharas

| art.     | Ø cm. | h. cm. |
|----------|-------|--------|
| 66313-03 | 6     | 9      |



SS

**Straw holder**

Porta cannuce  
Röhrchenbehälter  
Porte chalumeaux  
Porta canutillos

| art.     | Ø cm. | h. cm. |
|----------|-------|--------|
| 66313-06 | 8     | 12     |



SS

**Sugar packet holder**

Portabustine zucchero  
Zuckertütenschale  
Conteneur à sucre  
Contenedor sobres azúcar

| art.     | dim. cm. |
|----------|----------|
| 66374-00 | 13x6x4   |



SS

**Sugar packet holder**

Portabustine zucchero  
Zuckertütenschale  
Conteneur à sucre  
Contenedor sobres azúcar

| art.     | dim. cm. |
|----------|----------|
| 44104-15 | 9x7,5x5  |



PR

**Sugar packet holder**

Portabustine zucchero  
Zuckertütenschale  
Conteneur à sucre  
Contenedor sobres azúcar

| art.     | dim. cm. |
|----------|----------|
| 67303-64 | 11x6x4   |



**Sugar packet holder**

Portabustine zucchero  
Zuckertütenschale  
Conteneur à sucre  
Contenedor sobres azúcar

| art.     | dim. cm.  | col. |
|----------|-----------|------|
| 44104-01 | 8,5x6,5x5 | ●    |
| 44104-02 | 8,5x6,5x5 | ○    |



AY

**Tea-box**

Scatola portabustine tè  
Teebox  
Boîte à sachets de thé  
Caja para bolsitas de tè

| art.     | dim. cm. |
|----------|----------|
| 41614-22 | 22x17x9  |



W

**Tea-box**

Scatola portabustine tè  
Teebox  
Boîte à sachets de thé  
Caja para bolsitas de tè

| art.     | dim. cm.  |
|----------|-----------|
| 41614-33 | 33,5x20x9 |
| 41614-35 | 31x28x9   |



W

**Tea-box**

Scatola portabustine tè  
Teebox  
Boîte à sachets de thé  
Caja para bolsitas de tè

| art.     | dim. cm.  |
|----------|-----------|
| 41614-34 | 33,5x20x9 |
| 41614-36 | 31x28x9   |



NEW

PMMA

**Box With Lid**

Contentitore con coperchio  
Behälter mit Deckel  
Boîte avec couvercle  
Recipiente con tapa

| art.     | dim. cm.      |
|----------|---------------|
| 41472-25 | 27,5x10,5x9,5 |

**Single compartment 8,5x8 cm.**  
Singolo comparto 8,5x8 cm.





NEW  
PMMA

**Paper napkins holder**

Porta tovaglioli  
Serviettenhalter  
Porte serviettes  
Porta servilletas

art. dim. cm.  
41472-12 18x6x10



NEW  
PMMA

**Paper napkins holder**

Porta tovaglioli  
Serviettenhalter  
Porte serviettes  
Porta servilletas

art. dim. cm.  
41472-13 18x6x11



SS

**Napkin holder**

Portatovaglioli  
Serviettenhalter  
Porte serviettes  
Servilletero

art. dim. cm.  
66391-00 10x3x8



SS

**Napkin holder**

Portatovaglioli  
Serviettenhalter  
Porte serviettes  
Servilletero

art. dim. cm.  
41602-00 17x3x7



SS

**Napkin dispenser**

Portatovaglioli  
Serviettenspende  
Porte serviettes  
Servilletero

art. dim. cm.  
41601-17 8,5x11x12,5



**Napkin holder, chrome plated wire**

Portatovaglioli in filo cromato  
Serviettenhalter, Metall verchromt  
Porte-serviettes en fil chromé  
Servilletero en hilo cromado

art. dim. cm.  
41617-05 19x19x6,5



**Napkin holder, chrome plated wire**

Portatovaglioli in filo cromato  
Serviettenhalter, Metall verchromt  
Porte-serviettes en fil chromé  
Servilletero en hilo cromado

art. dim. cm.  
41617-15 19x19x19



**Napkin holder, chrome plated wire**

Portatovaglioli in filo cromato  
Serviettenhalter, Metall verchromt  
Porte-serviettes en fil chromé  
Servilletero en hilo cromado

art. dim. cm.  
41618-14 14x14x6,5



**Cash tray, 18 Cr s/s**

Vassoio conto, inox 18 Cr  
Rechnungstablett, Edelstahl 18 Cr  
Plateau porte-monnaie, inox 18 Cr  
Bandeja cuentas, acero 18 Cr

art. dim. cm.  
66318-19 19x14  
66318-22 22x15



NEW  
W

**Coffee set 4 pieces**

Servizio caffè 4 pezzi  
Kaffeaset 4 Stk  
Service à café 4 pièces  
Servicio de café 4 piezas

art. dim. cm.  
41206-03 25x18,7x2,5

Acacia wood. – Acacia.



SS

**Pastry stand, 2 tiers**

Alzata dolci, 2 piani  
Gebäckständer, 2-stufig  
Serviceur muet, 2 étages  
Soporte dulces, 2 niveles

art. Ø cm. h. cm.  
66339-02 12/16 20



PMMA

**Showcase**

Vetrina brioches  
Vitrine für Brioches  
Vitrine brioches  
Vitrina brioches

art. dim. cm.  
41472-32 37x31x31



ABS

SAN



**Showcase**

Vetrina da banco  
Vitrine für Verkaufstheke  
Vitrine à comptoir  
Vitrina

art. dim. cm.  
47091-01 44x32x20,5

**Double side opening. Equipped with s/s tray and coolers.** – Apertura doppio fronte. Con vassoio inox e eutettici.



ABS

SAN



**Showcase, 2 tiers**

Vetrina da banco, 2 piani  
Vitrine für Verkaufstheke, doppeldecker  
Vitrine à comptoir, 2 étages  
Vitrina, doble

art. dim. cm.  
47091-02 44x32x44

**Double side opening. Equipped with s/s trays and coolers.** – Apertura doppio fronte. Con vassoi inox e eutettici.



AY

PP

**Sweet box**

Contentitore universale  
Universalbox  
Boîte à comptoir  
Exibidor

art. dim. cm.  
47090-23 23x14,5x15



MF

**Cake tray**

Piatto torta  
Tortenplatte  
Plat gâteau  
Bandeja pasteles

art. Ø cm. h. cm.  
44845-31 31 4



SS

**Swivel cake stand**

Alzata torta girevole  
Tortenplatte drehbar  
Gueridon pâtissier tournante  
Pedestal giratorio para tartas

art. Ø cm. h. cm.  
47101-31 30,5 9



PS

**Dome cover**

Cloche  
Abdeckhaube  
Cloche  
Campana

art. Ø cm. h. cm.  
41414-30 30 9,5

Per art/for item: 44845-31/47101-31



MF

**Round dish**

Piatto tondo  
Platte, rund  
Plat rond  
Bandeja redonda

art. Ø cm. h. cm.  
44845-38 38 2



SAN

**Roll-top cover**

Coperchio roll-top  
Rolltophaube  
Couvercle roll-top  
Campana roll-top

art. Ø cm. h. cm.  
41447-38 38 20

Per art/for item: 44845-38, 44475-78/79



SS

**Cake stand**

Alzata torta  
Tortenplatte  
Gueridon pâtissier  
Pedestal para tartas

art. Ø cm. h. cm.  
41538-30 30 5



SS

**Cake stand**

Alzata torta  
Tortenplatte  
Gueridon pâtissier  
Pedestal para tartas

art. Ø cm. h. cm.  
47099-30 30 10



MF

**Cake stand**

Alzata torta  
Tortenplatte  
Gueridon pâtissier  
Pedestal para tartas

art. Ø cm. h. cm.  
44873-08 31 8



MF

**Cake stand**

Alzata torta  
Tortenplatte  
Gueridon pâtissier  
Pedestal para tartas

art. Ø cm. h. cm.  
44873-16 31 16



**Cake stand**  
Alzata torta  
Tortenplatte  
Gueridon pâtissier  
Pedestal para tartas

art. dim. cm.  
44874-08 31x31x8



**Cake stand**  
Alzata torta  
Tortenplatte  
Gueridon pâtissier  
Pedestal para tartas

art. dim. cm.  
44874-16 31x31x16



**Dome cover**  
Campana  
Haube  
Cloche  
Campana

art. Ø cm. h. cm.  
41414-31 30 22

Per art/for item: 44873-08/-16, 44475-79,  
41586-33, 41587-32, 44845-31, 47101-31.



**Cake platter**  
Piatto torta  
Tortenplatte  
Plat gâteau  
Bandeja pasteles

art. Ø cm. h. cm.  
44475-76 30,0 2  
44475-78 38,5 2



**Cake platter**  
Piatto torta  
Tortenplatte  
Plat gâteau  
Bandeja pasteles

art. Ø cm. h. cm.  
44475-77 30,0 2  
44475-79 38,5 2



**Cake stand**  
Alzata torta  
Tortenplatte  
Gueridon pâtissier  
Pedestal para tartas

art. Ø cm. h. cm.  
44475-80 11,5-15 10,5  
44475-82 11,5-15 20,0



**Cake stand**  
Alzata torta  
Tortenplatte  
Gueridon pâtissier  
Pedestal para tartas

art. Ø cm. h. cm.  
44475-81 21-15 10,5  
44475-83 21-15 20,0



# ICE CREAM GELATERIA

BAR HAPPY HOUR





SS

**Ice cream container**

Bacinella per gelato  
Eisbehälter  
Réceptient à glace  
Cubeta helado

| art.     | dim. cm. | lt. |
|----------|----------|-----|
| 41487-12 | 26x16x12 | 3,5 |
| 41487-15 | 26x16x15 | 4,1 |
| 41487-17 | 26x16x17 | 4,5 |



SS

**Ice cream container**

Bacinella per gelato  
Eisbehälter  
Réceptient à glace  
Cubeta helado

| art.     | dim. cm.   | lt. |
|----------|------------|-----|
| 41471-12 | 36x16,5x12 | 5,0 |
| 41471-15 | 36x16,5x15 | 6,5 |
| 41471-17 | 36x16,5x17 | 7,5 |



SS

**Ice cream container**

Bacinella per gelato  
Eisbehälter  
Réceptient à glace  
Cubeta helado

| art.     | dim. cm. | lt. |
|----------|----------|-----|
| 41486-08 | 36x25x8  | 5   |
| 41486-12 | 36x25x12 | 8   |
| 41486-15 | 36x25x15 | 10  |



NEW

PC

**Ice cream container**

Bacinella per gelato  
Eisbehälter  
Réceptient à glace  
Cubeta helado

| art.     | dim. cm.   | lt. |
|----------|------------|-----|
| 41431-12 | 36x16,5x12 | 5,4 |



NEW

PC

**Ice cream container**

Bacinella per gelato  
Eisbehälter  
Réceptient à glace  
Cubeta helado

| art.     | dim. cm. | lt. |
|----------|----------|-----|
| 41431-08 | 36x25x8  | 5,0 |



PMMA

**Lid for ice cream container**

Coperchio per bacinella gelato  
Deckel für Eisbehälter  
Couvercle pour réceptient à glace  
Tapa para cubeta helado

| art.     | dim. cm. |
|----------|----------|
| 41471-00 | 36x16,5  |



NEW

PC

**Lid for ice cream container**

Coperchio per bacinella gelato  
Deckel für Eisbehälter  
Couvercle pour réceptient à glace  
Tapa para cubeta helado

| art.     | dim. cm. |
|----------|----------|
| 41486-00 | 36x16,5  |
| 41486-01 | 36x25    |



SS

**Ice cream basin**

Carapina  
Eisbehälter  
Réceptient à glace  
Cubeta helados

| art.     | Ø cm. | h. cm. | lt. |
|----------|-------|--------|-----|
| 41489-20 | 20    | 25     | 7,3 |



NEW

SS

**Ice cream server**

Spatola gelato carapina  
Eisspachtel  
Palette à glace  
Paleta helados

| art.     | col. |
|----------|------|
| 41475-20 | ○    |



SS

**Ice cream server**

Spatola gelato  
Eisspachtel  
Palette à glace  
Paleta helados

| art.     | l. cm. | col. |
|----------|--------|------|
| 41475-00 | 27     | ○    |
| 41475-01 | 27     | ●    |
| 41475-03 | 27     | ●    |
| 41475-04 | 27     | ●    |
| 41475-05 | 27     | ●    |



**Ice-dipper**

Spatola gelato  
Eisdipper  
Cuillère à glace  
Cuchara helados

| art.     | Ø mm. | lt.  |
|----------|-------|------|
| 41468-20 | 55    | 1/20 |
| 41468-24 | 50    | 1/24 |

With liquid heat conductor in the handle.  
Con liquido conduttore nel manico.



**Ice-dipper**

Spatola gelato  
Eisdipper  
Cuillère à glace  
Cuchara helados

| art.     | Ø mm. | lt.  |
|----------|-------|------|
| 41469-20 | 55    | 1/20 |
| 41469-24 | 50    | 1/24 |

With liquid heat conductor in the handle.  
Con liquido conduttore nel manico.



SS

**Ice cream scoop**

Porzionatore  
Eisportionierer  
Cuillère à glace  
Racionador de helado

| art.     | Ø mm. | lt.  |
|----------|-------|------|
| 41476-50 | 50    | 1/24 |

**Non slip handle.** – Manico antiscivolo.



SS

**Ice cream scoop**

Porzionatore  
Eisportionierer  
Cuillère à glace  
Racionador de helado

| art.     | Ø mm. | lt.   |
|----------|-------|-------|
| 41473-31 | 30    | 1/100 |
| 41473-39 | 38    | 1/65  |
| 41473-44 | 43    | 1/50  |
| 41473-50 | 50    | 1/24  |
| 41473-56 | 55    | 1/20  |
| 41473-62 | 60    | 1/14  |
| 41473-66 | 66    | 1/12  |



**Ice cream scoop**

Porzionatore  
Eisportionierer  
Cuillère à glace  
Racionador de helado

| art.     | Ø mm. | lt.  |
|----------|-------|------|
| 41488-45 | 45    | 1/40 |
| 41488-47 | 47    | 1/36 |
| 41488-50 | 50    | 1/30 |
| 41488-53 | 53    | 1/24 |

**Nylon, fiberglass. Stainless steel mechanism.**  
Meccanismo in acciaio inox.



SS

**Oval ice cream scoop**

Porzionatore ovale  
Eisportionierer, oval  
Cuillère à glace ovale  
Racionador de helado oval

| art.     | Ø mm. | lt.  |
|----------|-------|------|
| 41474-00 | 60    | 1/30 |



SS

**Triangle ice cream scoop**

Porzionatore triangolare  
Eisportionierer, dreieckig  
Cuillère à glace triangle  
Racionador de helado triangular

| art.     | lt.  |
|----------|------|
| 41474-02 | 1/30 |



NEW

**Decorative scrapers 5 pcs**

Raschietti decorativi 5 pezzi  
Dekorative Schaber 5 Stk  
Raclettes décoratives 5 Pièces  
Rasquetas decorativas 5 pz

| art.     | dim. cm. |
|----------|----------|
| 41472-43 | 14,5x15  |

**PETG.**



**Chalkmarker**

Penna a gesso liquido  
Kreidestifte  
Stylo à craie liquide  
Marcadores de tiza líquida

| art.     | col. |
|----------|------|
| 47832-01 | ●    |
| 47832-03 | ●    |
| 47832-04 | ●    |
| 47832-05 | ●    |

**Writes on all non porous surfaces. Clean with water.** – Scrive su tutte le superfici non porose. Pulire con acqua.



NEW

PMMA

**Flavour marker holder 10 pcs**

Porta segnagusto 10 pezzi  
Eisschilderhalter 10 Stk  
Porte-étiquettes 10 pièces  
Porta etiquetas 10 pz

| art.     | mm.   |
|----------|-------|
| 41472-46 | 87x52 |

**Labels not included.** – Cartellino non incluso.



NEW

PMMA

**Flavour marker 10 pcs**

Segnagusto 10 pezzi  
Eisschilder 10 Stk  
Étiquettes 10 pièces  
Etiquetas sabores 10 pz

| art.     | mm.    |
|----------|--------|
| 41472-44 | 190x85 |



NEW

PMMA

**Flavour marker 10 pcs**

Segnagusto 10 pezzi  
Eisschilder 10 Stk  
Etiquettes 10 pièces  
Etiquetas sabores 10 pz

art. mm.  
41472-45 150x70



SS

**Counter ice cream cone holder**

Porta coni da banco  
Theke-Eiswaffelständer  
Porte cornets à glace de comptoir  
Expositor para cucuruchos

art. Ø cm. h. cm.  
41472-04 16,5 14



NEW

PMMA

**Counter ice cream cone holder**

Porta coni da banco  
Theke-Eiswaffelständer  
Porte cornets à glace de comptoir  
Expositor para cucuruchos

art. Ø mm. dim. cm.  
41472-07 3,5 21x8,5x11  
41472-08 3,5 28,5x8,5x11



SS

**Counter ice cream cone holder**

Porta coni da banco  
Theke-Eiswaffelständer  
Porte cornets à glace de comptoir  
Expositor para cucuruchos

art. dim. cm.  
41472-01 20x9,5x8,5



NEW

PMMA

**Paper napkins holder**

Porta tovaglioli  
Serviettenhalter  
Porte serviettes  
Porta servilletas

art. dim. cm.  
41472-12 18x6x10



NEW

PMMA

**Paper napkins holder**

Porta tovaglioli  
Serviettenhalter  
Porte serviettes  
Porta servilletas

art. dim. cm.  
41472-13 18x6x11



AY

PP

**Universal box**

Contenitore universale  
Universalbox  
Conteneur à comptoir  
Contenedor universal

art. dim. cm.  
47090-23 23x14,5x15



**NEW**  
PMMA

**Box with lid**

Contenitore con coperchio  
Behälter mit Deckel  
Boîte avec couvercle  
Recipiente con tapa

art. dim. cm.  
41472-25 27,5x10,5x9,5

**Compartments 8,5x8 cm. – Scomparti 8,5x8 cm.**



**NEW**  
PMMA

**Box with lid**

Contenitore con coperchio  
Behälter mit Deckel  
Boîte avec couvercle  
Recipiente con tapa

| art.     | Ø mm. | h. cm. |
|----------|-------|--------|
| 41472-26 | 10    | 15     |
| 41472-27 | 12    | 15     |
| 41472-28 | 15    | 15     |
| 41472-29 | 18    | 15     |



PMMA

**Waffle case**

Contenitore per cialde  
Waffelbehälter  
Porte gaufres  
Dispensador waffles

art. dim. cm.  
41472-21 22x26x12



PMMA

**Spoon case**

Contenitore per palette  
Eislöffelbehälter  
Porte cuillères à glace  
Dispensador cucharillas de helado

art. dim. cm.  
41472-20 19x12,5x14



PMMA

**Straws case**

Contenitore per cannuce  
Strohalmbehälter  
Porte chalumeaux  
Dispensador pajitas

art. dim. cm.  
41472-22 26x17x22



PMMA

**Cone holder, front opening**

Porta coni, apertura frontale  
Eiswaffelspender mit Frontöffnung  
Porte cornets à glace, ouverture frontale  
Porta cucuruchos, abertura frontal

art. dim. cm.  
41472-16 11x13x50



**NEW**  
PMMA

**Spoon and cup holder**

Porta palette e coppette  
Eislöffel und Schalenbehälter  
Porte cuillères et pots  
Dispensador cucharillas y copas

art. dim. cm.  
41472-17 28x25x55



**NEW**  
PMMA

**Cone holder 6 holes with spoon drawer**

Porta coni 6 fori c/porta palette  
Eiswaffelspender, 6 Löcher mit Palettenhalter  
Porte cornets 6 trous, porte cuillères  
Porta cucuruchos/cucharillas, 6 orificios

art. dim. cm.  
41472-18 25,5x18x60,5

**Upper hole Ø 3,5 cm. Lower Ø 2 cm. Distance between holes Ø 4,5 cm. Removable lower drawer. – Foro superiore Ø 3,5 cm. Inferiore Ø 2 cm. Distanza tra i fori Ø 4,5 cm. Cassetto inferiore estraibile.**



**NEW**  
PMMA

**Cone holder 12 holes**

Porta coni 12 fori  
Eiswaffelspender, 12 Löcher  
Porte cornets 12 trous  
Porta cucuruchos 12 orificios

art. dim. cm.  
41472-24 33x25x50

**Upper hole Ø 5,2 cm. Lower Ø 2 cm. Foro superiore Ø 5,2 cm. Inferiore Ø 2 cm.**





**NEW**

**PMMA**

**Swivel cone holder 5 sections**

Porta coni rotante 5 sezioni  
Eiswaffelspender, drehbar, 5 Fächer  
Porte cornets rotatif, 5 comp  
Porta cucurucho giratorio 5 secciones

art. Ø cm. h. cm.

41472-23 25 50

**Upper hole Ø 3,5 cm. Lower Ø 2 cm. Distance between holes Ø 4,5 cm. – Foro superiore Ø 3,5 cm. Inferiore Ø 2 cm. Distanza tra i fori Ø 4,5 cm.**



**NEW**

**PMMA**

**Cone holder with door**

Porta coni con porta  
Eiswaffelspender mit Tür  
Porte cornets ouverture frontale  
Porta cucurucho, abertura frontal

art. dim. cm.

41472-19 33x18x50



**NEW**

**PMMA**

**Horizontal cone holder with door**

Porta coni orizzontale con porta  
Eiswaffelspender horizontal mit Tür  
Porte cornets à glace horizontal  
Porta cucurucho horizontal

art. Ø cm. dim. cm.

41472-14 30 42x37x40,5

**With removable divider. – Con divisorio estraibile.**



**PMMA**

**Revolving cones dispenser**

Porta coni girevole  
Eiswaffelspender, drehbar  
Porte-cornets pivotant  
Distributor giratorio de cucurucho

art. Ø cm. h. cm.

41472-15 24 78



**MS**

**Ice cream cup**

Coppa gelato  
Eisbecher  
Coupe à glace  
Copa helado

art. h. cm. lt. U. Pack

44942-12 6,5 0,26 6



**MS**

**Ice cream cup**

Coppa gelato  
Eisbecher  
Coupe à glace  
Copa helado

art. h. cm. lt. U. Pack

44942-11 11 0,38 6



**MS**

**Ice cream cup**

Coppa gelato  
Eisbecher  
Coupe à glace  
Copa helado

art. h. cm. lt. U. Pack

44942-10 16 0,25 6



**MS**

**Ice cream cup**

Coppa gelato  
Eisbecher  
Coupe à glace  
Copa helado

art. Ø cm. h. cm. U. Pack

44942-06 10 10 6



**MS**

**Ice cream cup**

Coppa gelato  
Eisbecher  
Coupe à glace  
Copa helado

art. Ø cm. h. cm. U. Pack

44942-07 9 19 6

**BAR HAPPY HOUR**



MF

**Gourmet bowl**  
Ciotolina Gourmet  
Schälchen Gourmet  
Bol Gourmet  
Bol Gourmet

| art.     | Ø cm. | h. cm. | ml. |
|----------|-------|--------|-----|
| 44466-07 | 7     | 6      | 50  |



MF

**Gourmet tray**  
Vassoio Gourmet  
Tablett Gourmet  
Plateau Gourmet  
Bandeja Gourmet

| art.     | dim. cm.     |
|----------|--------------|
| 44466-30 | 30,5x9,5x2,5 |

**COMPOSTABLE - COMPOSTABILI**



An eco-friendly version of disposable items. Suitable both for pastry shops and events. Made of PLA INGEOTM, a revolutionary compostable and patented biopolymer that originates from plants and produced in a natural way.

Versione ecologica che rispetta l'ambiente. Realizzati il PLA INGEOTM, un rivoluzionario biopolimero compostabile e brevettato, derivato da piante e prodotto in modo naturale. Adatti sia nelle pasticcerie che per eventi.



**Glass**  
Bicchierino  
Glas  
Verrine  
Vaso

| art.     | Ø cm. | h. cm. | ml. |
|----------|-------|--------|-----|
| 48373-06 | 4,2   | 6,5    | 65  |
| 48373-09 | 5,0   | 6,5    | 90  |
| 48373-12 | 5,5   | 7,0    | 120 |
| 48373-17 | 6,0   | 9,0    | 170 |

Pcs/Conf. 100 pz.



**NATURAL ELEGANT**



A valid alternative to glass. Elegant and unbreakable ideals for HORECA pastry and ice cream sector. Made with high quality material that confers beside resistance also glossiness and perfect transparency. Bisphenol free. Thermal tolerance -18°C +70°C. 100% recyclable material. Dishwasher safe: up to 50 washes. Made in Italy.

La valida alternativa al vetro. Eleganti ed infrangibili ideali per il settore HORECA della pasticceria e gelateria. Realizzati con materiale di alta qualità che gli conferisce oltre alla resistenza anche lucidità e trasparenza. Privi di Bisfenolo. Tolleranza termica -18°C +70°C. Materiale riciclabile al 100%. Lavabili in lavastoviglie: fino a 50 lavaggi. Prodotti made in Italy.



NEW

**Bowl**  
Coppetta  
Schale  
Coupe  
Copa

| art.     | Ø cm. | h. cm. | ml. |
|----------|-------|--------|-----|
| 48367-10 | 7     | 5,9    | 105 |

Pcs/Conf. 100 pz.



NEW

**Glass**  
Bicchierino  
Glas  
Verrine  
Vaso

| art.     | dim. cm.    | des.          | ml. |
|----------|-------------|---------------|-----|
| 48371-10 | 7,3x6,4x5,2 | -             | 100 |
| 48371-11 |             | lid/coperchio |     |

Pcs/Conf. 100 pz.



PS

**Cup**  
Coppetta  
Schale  
Coupelle  
Bol

| art.     | Ø cm. | h. cm. | ml. |
|----------|-------|--------|-----|
| 48365-09 | 9     | 7,5    | 175 |

**Pcs/Conf. 100 pz.**



NEW

**Glass**  
Bicchierino  
Glas  
Verrine  
Vaso

| art.     | Ø cm.         | h. cm. | ml. |
|----------|---------------|--------|-----|
| 48370-10 | 7,8           | 5,7    | 210 |
| 48370-11 | lid/coperchio |        |     |

**Pcs/Conf. 100 pz.**



PS

**Cup**  
Coppetta  
Schale  
Coupelle  
Bol

| art.     | Ø cm. | h. cm. | ml. |
|----------|-------|--------|-----|
| 48366-09 | 9     | 7,5    | 125 |

**Pcs/Conf. 100 pz.**



PS

**Glass**  
Bicchierino  
Glas  
Verrine  
Vaso

| art.     | Ø cm. | h. cm. | ml. |
|----------|-------|--------|-----|
| 48354-01 | 4     | 8,5    | 70  |

**Pcs/Conf. 100 pz.**



PS

**Glass**  
Bicchierino  
Glas  
Verrine  
Vaso

| art.     | Ø cm. | h. cm. | ml. |
|----------|-------|--------|-----|
| 48350-01 | 4,2   | 6,5    | 50  |
| 48350-02 | 5,0   | 6,5    | 80  |
| 48350-03 | 5,5   | 7,0    | 100 |
| 48350-04 | 6,0   | 9,0    | 160 |

**Pcs/Conf. 100 pz.**



PS

**Glass**  
Bicchierino  
Glas  
Verrine  
Vaso

| art.     | Ø cm. | h. cm. | ml. |
|----------|-------|--------|-----|
| 48353-01 | 8,5   | 6,5    | 120 |

**Pcs/Conf. 100 pz.**



**PS**

**Glass**  
Bicchierino  
Glas  
Verrine  
Vaso

| art.     | dim. cm.  | ml. |
|----------|-----------|-----|
| 48351-01 | 4x4x5,5   | 50  |
| 48351-02 | 5x5x7     | 100 |
| 48351-03 | 5,5x5,5x8 | 150 |

**Pcs/Conf. 100 pz.**



**PS**

**Glass**  
Bicchierino  
Glas  
Verrine  
Vaso

| art.     | Ø cm. | h. cm. | ml. |
|----------|-------|--------|-----|
| 48352-01 | 6,5   | 5,5    | 70  |
| 48352-02 | 7,0   | 6,7    | 120 |
| 48352-03 | 7,5   | 7,3    | 150 |

**Pcs/Conf. 100 pz.**



**NEW**

**Ice tube mold**  
Stampo gelato  
Eisform  
Moule à glace  
Molde helado

| art.     | ml. |
|----------|-----|
| 41472-36 | 150 |

**Pcs/Conf. 100 pz.**



**NEW**

**PMMA**

**Ice cream counter display**  
Espositore per vetrina gelato  
Ständer für Eiscremetheke  
Présentoir de comptoir  
Expositor helados

| art.     | dim. cm.  | holes/fori |
|----------|-----------|------------|
| 41472-34 | 25x36x4,5 | 21         |
| 41472-35 | 16x36x4,5 | 15         |

**For mold/Per stampo: 41472-36.**



**NEW**

**PMMA**

**Holder for blast chiller**  
Supporto per abbattitore  
Ständer für Schnellabkühler  
Présentoir à cellule de refroidissement  
Soporte para abatidos

| art.     | dim. cm. | holes/fori |
|----------|----------|------------|
| 41472-33 | 29x39x12 | 28         |

**For mold/Per stampo: 41472-36.**



**NEW**

**Mini push up pops**

Stampi mini push up pops  
Mini push up pops Eisformen  
Moules à mini push up pops  
Mini push up pops moldes

| art.     | Ø cm. | h. cm. | ml. |
|----------|-------|--------|-----|
| 41472-37 | 4,0   | 18,8   | 90  |
| 41472-38 | 3,5   | 19,6   | 50  |

**Pcs/Conf. 100 pz.**



**NEW**

**PMMA**

**Ice cream counter display**

Espositore per vetrina gelato  
Ständer für Eiscremetheke  
Présentoir de comptoir  
Expositor helados

| art.     | dim. cm. | holes/fori |
|----------|----------|------------|
| 41472-39 | 25x36x4  | 21         |
| 41472-40 | 16x36x4  | 15         |

**For molds/Per stampi: 41472-37 - 41472-38.**



**NEW**

**PMMA**

**Display for mini ice cream cones**

Espositore per mini cornetti  
Waffelhörnchen-Ständer  
Présentoir à mini cornet à glace  
Expositor mini conos helado

| art.     | Ø cm. | dim. cm. | holes/fori |
|----------|-------|----------|------------|
| 41472-41 | 1,8   | 36x16,5  | 27         |
| 41472-42 | 1,8   | 36x25    | 45         |

**Suitable for all waffle minicones on the market.**  
Per tutti i miniconi in cialda in commercio.



**NEW**

**Ice cream mold, silicone**

Stampo gelato su stecco, silicone  
Eisform, Silikon  
Moule à glace, silicone  
Molde helado, silicona

| art.     | mm.      | ml. | pcs/pz |
|----------|----------|-----|--------|
| 41472-47 | 44x22x93 | 78  | 12     |

**Kit 2 molds of 6 pcs with white plastic tray and 50 pcs wooden sticks.** – Kit 2 stampi da 6 pz con vassoio in plastica e 50 bastoncini legno.



**NEW**

**PMMA**

**Ice cream counter display**

Espositore per vetrina gelato  
Ständer für Eiscremetheke  
Présentoir de comptoir  
Expositor helados

| art.     | dim. cm. | pcs/pz |
|----------|----------|--------|
| 41472-48 | 36x25x5  | 24     |

**For mold/Per stampo: 41472-47.**



**NEW**

**Tray with cover**

Vassoio con coperchio  
Tablett mit Deckel  
Plateau avec couvercle  
Bandeja con tapa Cm 59X39X8

| art.     | dim. cm. |
|----------|----------|
| 41472-50 | 59x39x8  |

**Unbreakable, shock resistant even at very low temperatures.** – Infrangibile, resistente agli urti anche a bassissime temperature.



**NEW**

**ABS**

**Tempering unit**

Temperatrice  
Temperiergerät  
Tempereuse  
Templadora

| art.     | Ø cm. | h. cm. | lt. |
|----------|-------|--------|-----|
| 47698-01 | 20,5  | 21,2   | 1,7 |

**Ideal for chocolate coatings of ice creams on sticks. Removable anodized aluminum tank.**  
Ideale per coperture in cioccolato di gelati e semifreddi su stecco. Vasca estraibile in alluminio anodizzato.



NEW  
ABS

**Tempering unit**

Temperatrice  
Temperiergerät  
Tempereuse  
Templadora

| art.     | Ø cm. | h. cm. | lt. |
|----------|-------|--------|-----|
| 47698-02 | 26    | 16     | 1,8 |

**Allows to process tiny chocolate quantities without any waste. Removable tank.**

Adatto per piccole produzioni senza sprechi. Pratica vasca estraibile.



SS

**Professional cream whipper**

Sifone panna professionale  
Profi-Sahnebereiter  
Siphon à crème professionnel  
Sifón montador de nata profesional

| art.     | lt. |
|----------|-----|
| 41451-05 | 0,5 |
| 41451-10 | 1,0 |



**Cream chargers, 10-pcs set**

Ricariche panna montata, conf. 10 pezzi  
10-Stk. Sahnekapseln-Packung  
Capsules à crème Chantilly, set 10 pièces  
Cápsulas para nata, 10 piezas

| art.     |
|----------|
| 41450-AA |

**Contains N2O under pressure.**  
Contiene N2O sotto pressione.



SS

**GOURMET-Cream whipper**

Sifone panna  
Sahnebereiter  
Siphon à crème  
Sifón para nata montada

| art.     | lt.  |
|----------|------|
| 41458-02 | 0,25 |
| 41458-05 | 0,50 |
| 41458-10 | 1,00 |

**Heat resistant silicone gasket. Keep warm in bain marie up to 75°C.** – Guarnizione in silicone resistente al calore. Tenere a bagnomaria max. a 75°C.



SS

**THERMO-Cream whipper**

Sifone termico  
Thermo-Sahnebereiter  
Siphon à crème, isotherme  
Sifón isotérmico

| art.     | lt. |
|----------|-----|
| 41455T55 | 0,5 |

**Double-walled, insulated bottle: keeps creations cold for 8 hours and hot for 3 hours, dishwasher-safe.** – Bottiglia termica, mantiene le preparazioni in caldo fino a 3 ore e a freddo fino a 8 ore.



SS

**THERMO SPRESS-Cream whipper**

Sifone termico  
Thermo-Sahnebereiter  
Siphon à crème, isotherme  
Sifón isotérmico

| art.     | h. cm. | lt. |
|----------|--------|-----|
| 41459-10 | 35     | 1   |

**Double-walled, insulated bottle, keeps creations cold for 8 hours and hot for 3 hours.** – Bottiglia termica, mantiene le preparazioni in caldo fino a 3 ore e a freddo fino a 8 ore, lavabile in lavastoviglie.



SS

**PROFI-Cream whipper**

Sifone panna  
Sahnebereiter  
Siphon à crème  
Sifón para nata montada

| art.     | lt. |
|----------|-----|
| 41460-05 | 0,5 |
| 41460-10 | 1,0 |

**Only for cold preparations.**  
Solo per preparazioni fredde.



**Decorating tips, 3-pcs set**

Bocchette, set 3 pezzi  
Dekorationstüllen, 3er Set  
Douilles de décoration, 3 pièces  
Boquillas de decoración, 3 piezas

| art.     |
|----------|
| 41455-BC |



SS

**Decorating tips, 3-pcs set**

Bocchette, set 3 pezzi  
Dekorationstüllen, 3er Set  
Douilles de décoration, 3 pièces  
Boquillas de decoración, 3 piezas

| art.     |
|----------|
| 41458-23 |



**Decorating tips and adapter**

Bocchette decoro e adattatore  
Dekorationstüllen-Set u. Adapter  
Douilles de décoration et adaptateur  
Boquillas de decoración y adaptador

art. 41458-24



**Injector needles**

Iniettori/siringhe decoro  
Nadeltüllen  
Aiguilles d'injection  
Boquillas de aguja

art. 41458-21



**Heat protector, silicone**

Protezione in silicone  
Silikonhülle  
Housse en silicone  
Protección de silicona

| art.     | lt. |
|----------|-----|
| 41458-50 | 0,5 |
| 41458-51 | 1,0 |



**Cream chargers, PROFESSIONAL**

Ricariche panna montata, PROFESSIONAL  
Sahnepapseln-Packung, PROFESSIONAL  
Capsules à crème Chantilly, PROFESSIONAL  
Cápsulas para nata, PROFESSIONAL

| art.     | pcs/pz |
|----------|--------|
| 41455-CA | 24     |
| 41455-CB | 50     |

**Filled with 8,4 g of N2O (E942, nitrous oxide).**  
Contenuto: 8,4 g di N2O (E942 protossido di azoto).



**Funnel and sieve**

Imbuto e colino  
Trichter und Sieb  
Entonnoir et tamis  
Embudo y tamiz

art. 41458-11



**Kit rapid infusion**

Kit di infusione rapida  
Rapid Infusion Set  
Paquet rapid infusion  
Rapid infusion set

art. 41458-25

**Enables a liquid to be infused with different flavors in the shortest possible time. First, combine aromatic solids (e.g. herbs, spices, fruit) and a liquid (e.g. alcohol, oil, water, vinegar) in the whipper then apply pressure into it using a cream charger.** – Permette di infondere un liquido con sapori diversi in tempo rapido. Unire gli aromi solidi (erbe, spezie, frutta, ecc.) con il liquido (alcol, olio, acqua, aceto, ecc.) nel sifone ed immettere una carica per panna.



# COCKTAIL BAR

BAR HAPPY HOUR



SPECIAL THANKS TO : Ristorante I GEMELLI Via San Marco, 26, 20121 Milano, Italia

Paderno offers a wide selection of bar equipment, designed to combine easy use with efficiency and style. The tools are flanked by fascinating accessories making every moment trendy and lively. To share refined happy hours, to enjoy spectacular cocktails and long drinks, or to add style to every sort of drink.

Paderno propone un'ampia selezione di attrezzature bar, ideata per unire praticità d'utilizzo a efficienza e stile. Agli utensili si affiancano affascinanti accessori in grado di rendere trendy e vivace ogni momento. Per condividere raffinati happy hour, per gustare scenografici cocktail e long drink, oppure per aggiungere stile a ogni tipo di bevanda.





SS

**Pumpkin mug**

Coppa zucca  
Kürbis-Becher  
Gobelet citrouille  
Vaso de calabaza

| art.     | Ø cm. | h. cm. | ml. | col. |
|----------|-------|--------|-----|------|
| 44944G07 | 10    | 14,5   | 700 | ●    |
| 44944C07 | 10    | 14,5   | 700 | ●    |



SS

**Pineapple cup with straw**

Coppa ananas con cannuccia  
Ananas-Becher mit Strohhalme  
Gobelet ananas avec paille  
Vaso de piña con pajita

| art.     | Ø cm. | h. cm. | ml. | col. |
|----------|-------|--------|-----|------|
| 44945G05 | 9,5   | 20,5   | 500 | ●    |
| 44945C05 | 9,5   | 20,5   | 500 | ●    |



SS

**Champagne glass**

Flute champagne  
Champagner Glas  
Verre champagne  
Copa champán

| art.     | Ø cm. | h. cm. | ml. | col. |
|----------|-------|--------|-----|------|
| 41493G00 | 5     | 25,5   | 270 | ●    |
| 41493C00 | 5     | 25,5   | 270 | ●    |
| 41493B00 | 5     | 25,5   | 270 | ●    |



SS

**Martini cup**

Coppa martini  
Martini Cocktail Glas  
Verre à martini  
Copa martini

| art.     | Ø cm. | h. cm. | ml. | col. |
|----------|-------|--------|-----|------|
| 41494G00 | 12    | 16,5   | 200 | ●    |
| 41494C00 | 12    | 16,5   | 200 | ●    |
| 41494B00 | 12    | 16,5   | 200 | ●    |



SS

**Margarita cup**

Coppa margarita  
Margarita Cocktail Glas  
Verre à margarita  
Copa margarita

| art.     | Ø cm. | h. cm. | ml. | col. |
|----------|-------|--------|-----|------|
| 41498G00 | 10,5  | 14     | 220 | ●    |
| 41498C00 | 10,5  | 14     | 220 | ●    |
| 41498B00 | 10,5  | 14     | 220 | ●    |



SS

**Moscow mule mug**

Tazza moscow mule  
Moscow Mule Becher  
Gobelet moscow mule  
Taza moscow mule

| art.     | Ø cm. | h. cm. | ml. | col. |
|----------|-------|--------|-----|------|
| 41463-01 | 8,9   | 9      | 500 | ●    |





SS

**Moscow mule mug**  
Tazza moscow mule  
Moscow Mule Becher  
Gobelet moscow mule  
Taza moscow mule

| art.     | Ø cm. | h. cm. | ml. | col. |
|----------|-------|--------|-----|------|
| 41463-02 | 8,5   | 9,7    | 500 | ●    |

**Gold plated handle. – Manico dorato.**



SS

**Moscow mule mug, antique**  
Tazza moscow mule, antique  
Moscow Mule Becher, Antik  
Gobelet moscow mule, antique  
Taza moscow mule, antiguo

| art.     | Ø cm. | h. cm. | ml. | col. |
|----------|-------|--------|-----|------|
| 41463A05 | 8,5   | 9,7    | 500 | ●    |

**Gold plated handle. – Manico dorato.**



SS

**Moscow mule mug**  
Tazza moscow mule  
Moscow Mule Becher  
Gobelet moscow mule  
Taza moscow mule

| art.     | Ø cm. | h. cm. | ml. | col. |
|----------|-------|--------|-----|------|
| 41463G05 | 8,5   | 9,7    | 500 | ●    |

**Gold plated handle. – Manico dorato.**



SS

**Moscow mule mug**  
Tazza moscow mule  
Moscow Mule Becher  
Gobelet moscow mule  
Taza moscow mule

| art.     | Ø cm. | h. cm. | ml. | col. |
|----------|-------|--------|-----|------|
| 41463B05 | 8,5   | 9,7    | 500 | ●    |

**Gold plated handle. – Manico dorato.**



NEW

SS

**Moscow mule mug**  
Tazza moscow mule  
Moscow Mule Becher  
Gobelet moscow mule  
Taza moscow mule

| art.     | Ø cm. | h. cm. | ml. |
|----------|-------|--------|-----|
| 41463M05 | 8,5   | 10     | 550 |

**Water transfer printing. Gold plated handle.**  
Stampa a trasferimento ad acqua. Manico dorato.



SS

**Moscow mule mug**  
Tazza moscow mule  
Becher Moscow Mule  
Gobelet moscow mule  
Taza moscow mule

| art.     | Ø cm. | h. cm. | lt. | col. |
|----------|-------|--------|-----|------|
| 41463C30 | 15,5  | 17,5   | 3   | ●    |
| 41463C50 | 18,0  | 20,0   | 5   | ●    |

**Gold plated handle. – Manico dorato.**



SS

**Moscow mule mug, antique**  
Tazza moscow mule, antique  
Becher Moscow Mule, Antik  
Gobelet moscow mule, antique  
Taza moscow mule, antiguo

| art.     | Ø cm. | h. cm. | lt. | col. |
|----------|-------|--------|-----|------|
| 41463A30 | 15,5  | 17,5   | 3   | ●    |
| 41463A50 | 18,0  | 20,0   | 5   | ●    |

**Gold plated handle. – Manico dorato.**



SS

**Mini moscow mule mug**  
Mini moscow mule  
Moscow Mule Shotbecher  
Moscow mule à shot  
Chupito moscow mule

| art.     | Ø cm. | h. cm. | ml. | col. |
|----------|-------|--------|-----|------|
| 41463C00 | 4,6   | 4,7    | 60  | ●    |

Gold plated handle. Set 4 pcs. – Manico dorato. Conf. 4 pz.



SS

**Mini moscow mule mug, antique**  
Mini moscow mule, antique  
Moscow Mule Shotbecher, Antik  
Moscow mule à shot, antique  
Chupito moscow mule, antiguo

| art.     | Ø cm. | h. cm. | ml. | col. |
|----------|-------|--------|-----|------|
| 41463A00 | 4,6   | 4,7    | 60  | ●    |

Gold plated handle. Set 4 pcs. – Manico dorato. Conf. 4 pz.



NEW

SS

**Cola cup**  
Tazza Cola  
Cola-Becher  
Gobelet Cola  
Taza Cola

| art.     | Ø cm. | h. cm. | ml. | col. |
|----------|-------|--------|-----|------|
| 44941G05 | 7,5   | 11     | 490 | ●    |
| 44941C05 | 7,5   | 11     | 490 | ●    |
| 44941B05 | 7,5   | 11     | 490 | ●    |



SS

**Mint julep cup**  
Coppa mint julep  
Becher für Mint Julep  
Tasse à cocktail mint julep  
Vaso para mint julep

| art.     | Ø cm. | h. cm. | ml. | col. |
|----------|-------|--------|-----|------|
| 41497-05 | 8,5   | 10,5   | 380 | ●    |
| 41497G05 | 8,5   | 10,5   | 380 | ●    |
| 41497C05 | 8,5   | 10,5   | 380 | ●    |
| 41497B05 | 8,5   | 10,5   | 380 | ●    |



SS

**Julep mug**  
Tazza julep  
Becher Julep  
Gobelet julep  
Taza julep

| art.     | Ø cm. | h. cm. | ml. | col. |
|----------|-------|--------|-----|------|
| 41470C03 | 8     | 12     | 335 | ●    |



SS

**Julep mug, antique**  
Tazza julep, antique  
Becher Julep, Antik  
Gobelet julep, antique  
Taza julep, antiguo

| art.     | Ø cm. | h. cm. | ml. | col. |
|----------|-------|--------|-----|------|
| 41470A03 | 8     | 12     | 335 | ●    |



SS

**Mini mug**  
Mini tazza  
Shotbecher  
Verre à shot  
Vaso de chupito

| art.     | Ø cm. | h. cm. | ml. | col. |
|----------|-------|--------|-----|------|
| 41470C00 | 4,5   | 5,5    | 60  | ●    |

Set 4 pcs. – Conf. 4 pz.



SS

**Mini mug, antique**  
Mini tazza, antique  
Shotbecher, Antik  
Verre à shot, antique  
Vaso de chupito, antiguo

| art.     | Ø cm. | h. cm. | ml. | col. |
|----------|-------|--------|-----|------|
| 41470A00 | 4,5   | 5,5    | 60  | ●    |

Set 4 pcs. – Conf. 4 pz.



NEW

**Tiki skull glass**  
Tiki mug teschio in vetro  
Tiki-Schädelglas  
Tiki mug crâne en verre  
Vaso Tiki de vidrio

| art.     | Ø cm. | h. cm. | ml. |
|----------|-------|--------|-----|
| 44948-07 | 13    | 10,5   | 700 |





NEW

**Tiki mug ceramic**

Tiki mug in ceramica  
Tiki-Becher aus Keramik  
Tiki mug en céramique  
Taza Tiki en cerámica

| art.     | Ø cm. | h. cm. | ml. |
|----------|-------|--------|-----|
| 44949-01 | 9,3   | 11     | 450 |



NEW

**Tiki mug ceramic**

Tiki mug in ceramica  
Tiki-Becher aus Keramik  
Tiki mug en céramique  
Taza Tiki en cerámica

| art.     | h. cm. | ml. |
|----------|--------|-----|
| 44949-02 | 22     | 500 |



NEW

**Tiki mug ceramic**

Tiki mug in ceramica  
Tiki-Becher aus Keramik  
Tiki mug en céramique  
Taza Tiki en cerámica

| art.     | Ø cm. | h. cm. | ml. |
|----------|-------|--------|-----|
| 44949-03 | 7     | 21,5   | 650 |



NEW

**Tiki mug ceramic**

Tiki mug in ceramica  
Tiki-Becher aus Keramik  
Tiki mug en céramique  
Taza Tiki en cerámica

| art.     | h. cm. | ml. |
|----------|--------|-----|
| 44949-04 | 15     | 550 |



NEW

**Tiki mug ceramic**

Tiki mug in ceramica  
Tiki-Becher aus Keramik  
Tiki mug en céramique  
Taza Tiki en cerámica

| art.     | Ø cm. | h. cm. | ml. |
|----------|-------|--------|-----|
| 44949-05 | 8     | 16,5   | 340 |



NEW

**Tiki mug ceramic**

Tiki mug in ceramica  
Tiki-Becher aus Keramik  
Tiki mug en céramique  
Taza Tiki en cerámica

| art.     | Ø cm. | h. cm. | ml. |
|----------|-------|--------|-----|
| 44949-06 | 8     | 17     | 510 |



PVD

SS

**Straight straws**

Cannucce  
Strohhalme  
Pailles  
Pajitas

| art.     | Ø mm. | l. cm. | col. |
|----------|-------|--------|------|
| 41490-00 | 6     | 21,5   | ●    |
| 41490B00 | 6     | 21,5   | ●    |
| 41490G00 | 6     | 21,5   | ●    |
| 41490C00 | 6     | 21,5   | ●    |

Set 12 pcs plus 1 straw brush.  
Conf. 12 pz + 1 scovolino.



PVD

SS

**Curved straws**

Cannucce curve  
Gebogene Strohhalme  
Pailles incurvées  
Pajitas curvados

| art.     | Ø mm. | l. cm. | col. |
|----------|-------|--------|------|
| 41490-01 | 6     | 21,5   | ●    |
| 41490B01 | 6     | 21,5   | ●    |
| 41490G01 | 6     | 21,5   | ●    |
| 41490C01 | 6     | 21,5   | ●    |

Set 12 pcs plus 1 straw brush.  
Conf. 12 pz + 1 scovolino.



SS

**Straw brush, 5 pcs**

Scovolini, 5 pezzi  
Strohhalme-Bürste, 5 Stk.  
Brosses à pailles, 5 pièces  
Cepillos para pajitas, 5 pz

| art.     | l. cm. |
|----------|--------|
| 41490-AA | 21     |



**B**

**Straight straws, 24 pcs**

Cannucce, 24 pz  
Strohhalme, 24 Stk  
Pailles, 24 pièces  
Pajitas, 24 piezas

| art.     | Ø mm. | l.  |
|----------|-------|-----|
| 48310-14 | 5-7   | 140 |
| 48310-20 | 5-7   | 200 |



**B**

**Straight straws, 150 pcs**

Cannucce, 150 pz  
Strohhalme, 150 Stk  
Pailles, 150 pièces  
Pajitas, 150 piezas

| art.     | Ø mm. | l.  |
|----------|-------|-----|
| 48311-20 | 6-8   | 200 |
| 48311-25 | 6-8   | 250 |



**B**

**Straight straws, 110 pcs**

Cannucce, 110 pz  
Strohhalme, 110 Stk  
Pailles, 110 pièces  
Pajitas, 110 piezas

| art.     | Ø mm. | l.  |
|----------|-------|-----|
| 48312-25 | 9-10  | 250 |



**B**

**Straight straws, 24 pcs**

Cannucce, 24 pz  
Strohhalme, 24 Stk  
Pailles, 24 pièces  
Pajitas, 24 piezas

| art.     | Ø mm. | l.  |
|----------|-------|-----|
| 48313-14 | 10-12 | 140 |
| 48313-18 | 10-12 | 180 |
| 48313-20 | 10-12 | 200 |



**3 Straight straws, 3 bent, glass**

3 Cannucce diritte, 3 curve in vetro  
3 Gerade Strohhalme, 3 gebogene aus Glas  
3 Pailles droites, 3 incurvés en verre  
3 Pajitas eectas, 3 curvados de vidrio

| art.     | Ø mm. | l.  |
|----------|-------|-----|
| 41495-08 | 8     | 215 |
| 41495-10 | 10    | 215 |

**Incl. 2 straw brushes. – Incl. 2 scovolini.**



**SS**

**Drinks stirrers flamingo, 4 pcs**

Miscelatori cocktail fenicottero, 4 pz  
Flamingo-Cocktail Rührer, 4 Stk  
Agitateurs cocktails flamant, 4 pcs  
Agitadores cócteles flamingo, 4 pz

| art.     | l. cm. | col. |
|----------|--------|------|
| 41491G00 | 21,5   | ●    |
| 41491C00 | 21,5   | ●    |



**SS**

**Drinks stirrers skull, 4 pcs**

Miscelatori cocktail teschio, 4 pz  
Totenkopf-Cocktail Rührer, 4 Stk  
Agitateurs tête de mort, 4 pcs  
Agitadores cócteles cráneo, 4 pz

| art.     | l. cm. | col. |
|----------|--------|------|
| 41491G01 | 18,5   | ●    |
| 41491C01 | 18,5   | ●    |



**SS**

**Drinks stirrers pineapple, 4 pcs**

Miscelatori cocktail ananas, 4 pz  
Ananas-Cocktail Rührer, 4 Stk  
Agitateurs cocktails ananas, 4 pcs  
Agitadores cócteles piña, 4 pz

| art.     | l. cm. | col. |
|----------|--------|------|
| 41491G02 | 20     | ●    |
| 41491C02 | 20     | ●    |



SS

**Drinks stirrers owl, 4 pcs**

Miscelatori cocktail gufo, 4 pz  
Eule-Cocktail Rührer, 4 Stk  
Agitateurs cocktails hibou, 4 pcs  
Agitadores cócteles búho, 4 pz

| art.     | l. cm. | col. |
|----------|--------|------|
| 41491G03 | 20     | ●    |
| 41491C03 | 20     | ●    |



SS

**Drinks stirrers seahorse, 4 pcs**

Miscelatori cavalluccio marino, 4 pz  
Seepferdchen-Cocktail Rührer, 4 Stk  
Agitateurs hippocampe, 4 pcs  
Agitadores caballo de mar, 4 pz

| art.     | l. cm. | col. |
|----------|--------|------|
| 41491G04 | 20,5   | ●    |
| 41491C04 | 20,5   | ●    |



SS

**Drinks stirrers bow-knot, 4 pcs**

Miscelatori cocktail fiocco, 4 pz  
Bogenknoten-Cocktail Rührer, 4 Stk  
Agitateurs noeud d'arc, 4 pcs  
Agitadores nudo de proa, 4 pz

| art.     | l. cm. | col. |
|----------|--------|------|
| 41491G05 | 21     | ●    |
| 41491C05 | 21     | ●    |



SS

**Drinks stirrers octopus, 4 pcs**

Miscelatori cocktail polipo, 4 pz  
Tintenfisch-Cocktail Rührer, 4 Stk  
Agitateurs cocktails poulpe, 4 pcs  
Agitadores cócteles pulpo, 4 pz

| art.     | l. cm. | col. |
|----------|--------|------|
| 41491G06 | 18,5   | ●    |
| 41491C06 | 18,5   | ●    |



SS

**Tweezer**

Pinza  
Zange  
Pince  
Pinza

| art.     | l. cm. | col. |
|----------|--------|------|
| 42902-30 | 30     | ●    |
| 42902G30 | 30     | ●    |



SS

**Tweezer**

Pinza  
Zange  
Pince  
Pinza

| art.     | l. cm. | col. |
|----------|--------|------|
| 42902C30 | 30     | ●    |
| 42902B30 | 30     | ●    |



SS

**Tweezer**

Pinza  
Zange  
Pince  
Pinza

| art.     | l. cm. |
|----------|--------|
| 42902-31 | 30     |



SS

**Cocktail spoon**

Cucchiaio miscelatore  
Cocktail-Löffel  
Cuillère à cocktail  
Cuchara cóctel

| art.     | l. cm. |
|----------|--------|
| 41605-00 | 27     |



SS

**Cocktail spoon**

Cucchiaio miscelatore  
Cocktail-Löffel  
Cuillère à cocktail  
Cuchara cóctel

| art.     | l. cm. | col. |
|----------|--------|------|
| 41605-01 | 28     | ●    |



SS

**Cocktail spoon**

Cucchiaio miscelatore  
Cocktail-Löffel  
Cuillère à cocktail  
Cuchara cóctel

| art.     | l. cm. | col. |
|----------|--------|------|
| 41605G27 | 28     | ●    |
| 41605B27 | 28     | ●    |



SS

**Cocktail spoon/fork**

Cucchiaio/forchetta miscelatore  
Cocktail-Löffell/-Gabel  
Cuillère/fourchette à cocktail  
Cuchara/tenedor cóctel

| art.     | l. cm. | col. |
|----------|--------|------|
| 41605-03 | 50     | ●    |
| 41605G03 | 50     | ●    |



SS

**Cocktail spoon/fork**

Cucchiaio/forchetta miscelatore  
Cocktail-Löffell/-Gabel  
Cuillère/fourchette à cocktail  
Cuchara/tenedor cóctel

| art.     | l. cm. | col. |
|----------|--------|------|
| 41605C03 | 50     | ●    |
| 41605B03 | 50     | ●    |





SS

**Ice tea spoon**

Cucchiaio bibita  
Limonadenlöffel  
Cuillère à soda  
Cuchara refresco

| art.     | l. cm. | U. Pack |
|----------|--------|---------|
| 41605-25 | 25     | 6       |



SS

**Absinthe spoon**

Cucchiaio assenzio  
Absinth-Löffel  
Cuillère d'absinthe  
Cuchara de ajenjo

| art.     | l. cm. | col. |
|----------|--------|------|
| 41600-00 | 16     | ●    |
| 41600G00 | 16     | ●    |
| 41600C00 | 16     | ●    |



SS

**Magic spoon whisks**

Cucchiaio magico  
Zauberlöffel  
Fouet plat à spirales  
Cuchara mágica

| art.     | l. cm. |
|----------|--------|
| 41595-20 | 20     |



SS

**Strainer**

Colino  
Sieb  
Passoire  
Colador

| art.     | Ø cm. | col. |
|----------|-------|------|
| 41570-10 | 10    | ●    |
| 41570G10 | 10    | ●    |



SS

**Strainer**

Colino  
Sieb  
Passoire  
Colador

| art.     | Ø cm. | col. |
|----------|-------|------|
| 41570C10 | 10    | ●    |
| 41570B10 | 10    | ●    |



SS

**Cocktail strainer**

Colino cocktail  
Cocktail-Sieb  
Passoire à cocktail  
Colador cóctel

| art.     | Ø cm. | col. |
|----------|-------|------|
| 41603-00 | 9     | ●    |
| 41603G00 | 9     | ●    |



SS

**Cocktail strainer**

Colino cocktail  
Cocktail-Sieb  
Passoire à cocktail  
Colador cóctel

| art.     | Ø cm. | col. |
|----------|-------|------|
| 41603C00 | 9     | ●    |
| 41603B00 | 9     | ●    |



SS

**Julep strainer**

Colino Julep  
Julep Barsieb  
Tamis cocktail Julep  
Colador de cóctel

| art.     | Ø cm. | col. |
|----------|-------|------|
| 41603-07 | 7,5   | ●    |
| 41603G07 | 7,5   | ●    |



SS

**Julep strainer**

Colino Julep  
Julep Barsieb  
Tamis cocktail Julep  
Colador de cóctel

| art.     | Ø cm. | col. |
|----------|-------|------|
| 41603C07 | 7,5   | ●    |
| 41603B07 | 7,5   | ●    |





SS

**Cocktail measuring cup**

Misurino cocktail  
Alkohol-Meßbecher  
Mesureur de cocktail  
Medidor de cóctel

| art.     | ml. |
|----------|-----|
| 41609-75 | 75  |



SS

**Cocktail measuring cup**

Misurino cocktail  
Alkohol-Meßbecher  
Mesureur de cocktail  
Medidor de cóctel

| art.     | ml.   | col. |
|----------|-------|------|
| 41609-36 | 30/60 | ●    |
| 41609G36 | 30/60 | ●    |
| 41609C36 | 30/60 | ●    |
| 41609B36 | 30/60 | ●    |



SS

**Cocktail measuring cup**

Misurino cocktail  
Alkohol-Meßbecher  
Mesureur de cocktail  
Medidor de cóctel

| art.     | ml.   | col. |
|----------|-------|------|
| 41604-00 | 20/40 | ●    |
| 41604G00 | 20/40 | ●    |
| 41604C00 | 20/40 | ●    |
| 41604B00 | 20/40 | ●    |



SS

**Japanese jigger**

Misurino cocktail  
Cocktail-Doppelmaß  
Mesure double jigger  
Medidor de cóctel

| art.     | ml.   | col. |
|----------|-------|------|
| 41604-01 | 20/40 | ●    |
| 41604G01 | 20/40 | ●    |
| 41604C01 | 20/40 | ●    |
| 41604B01 | 20/40 | ●    |



SS

**Long-drink shaker**

Shaker  
Shaker  
Shaker  
Coctelera

| art.     | Ø cm. | h. cm. | ml. | col. |
|----------|-------|--------|-----|------|
| 41484-05 | 8,8   | 20,5   | 500 | ●    |
| 41484G05 | 8,8   | 20,5   | 500 | ●    |
| 41484C05 | 8,8   | 20,5   | 500 | ●    |
| 41484B05 | 8,8   | 20,5   | 500 | ●    |



SS

**Long-drink shaker**

Shaker  
Shaker  
Shaker

**Coctelera**

| art.     | ml. |
|----------|-----|
| 41480-03 | 200 |
| 41480-05 | 500 |
| 41480-07 | 700 |



SS

SAN

**Long-drink shaker**

Shaker  
Shaker  
Shaker

**Coctelera**

| art.     | ml. | col. |
|----------|-----|------|
| 41481-02 | 550 | ●    |
| 41481-03 | 550 | ●    |



AY

**Long-drink shaker**

Shaker  
Shaker  
Shaker

**Coctelera**

| art.     | ml. |
|----------|-----|
| 41483-04 | 420 |
| 41483-06 | 660 |



SS

**Long-drink shaker**

Shaker  
Shaker  
Shaker

**Coctelera**

| art.     | Ø cm. | h. cm. | ml. | col. |
|----------|-------|--------|-----|------|
| 41480G05 | 8,7   | 20,5   | 500 | ●    |
| 41480C05 | 8,7   | 20,5   | 500 | ●    |
| 41480B05 | 8,7   | 20,5   | 500 | ●    |



SS

**Shaker parisienne**

Shaker parisienne  
Shaker parisienne  
Shaker parisienne

**Coctelera parisienne**

| art.     | Ø cm. | h. cm. | ml. | col. |
|----------|-------|--------|-----|------|
| 41461-07 | 9     | 23     | 700 | ●    |
| 41461G07 | 9     | 23     | 700 | ●    |
| 41461C07 | 9     | 23     | 700 | ●    |
| 41461B07 | 9     | 23     | 700 | ●    |



SS

**Shaker calabrese**

Shaker calabrese  
Shaker Calabrese  
Shaker calabrese

**Coctelera calabrese**

| art.     | Ø cm. | h. cm. | ml. | col. |
|----------|-------|--------|-----|------|
| 41464-09 | 9,5   | 24,5   | 900 | ●    |
| 41464G09 | 9,5   | 24,5   | 900 | ●    |
| 41464C09 | 9,5   | 24,5   | 900 | ●    |
| 41464B09 | 9,5   | 24,5   | 900 | ●    |



SS

**Boston tin + half tin**

Shaker boston 2 pz  
Boston Shaker, 2 Stk  
Shaker boston, 2 pcs  
Coctelera boston, 2 pz

| art.     | Ø cm. | ml.     | col. |
|----------|-------|---------|------|
| 41467G08 | 9     | 790/590 | ●    |
| 41467C08 | 9     | 790/590 | ●    |
| 41467B08 | 9     | 790/590 | ●    |



SS

**Boston shaker, vinyl coated**

Cono boston, rivestimento vinile  
Boston-Shaker, Vinyl Überzug  
Shaker boston, revêtement en vinyle  
Coctelera boston, revestimiento vinilo

| art.     | Ø cm. | h. cm. | ml. | col. |
|----------|-------|--------|-----|------|
| 41479-11 | 9     | 18     | 830 | ●    |
| 41479-15 | 9     | 18     | 830 | ○    |



SS

**Boston shaker, vinyl coated**

Cono boston, rivestimento vinile  
Boston-Shaker, Vinyl Überzug  
Shaker boston, revêtement en vinyle  
Coctelera boston, revestimiento vinilo

| art.     | Ø cm. | h. cm. | ml. | col. |
|----------|-------|--------|-----|------|
| 41479-12 | 9     | 18     | 830 | ●    |
| 41479-13 | 9     | 18     | 830 | ●    |
| 41479-14 | 9     | 18     | 830 | ●    |



SS

**Boston shaker**

Cono boston con fondello  
Boston-Shaker  
Shaker boston  
Coctelera boston

| art.     | Ø cm. | h. cm. | ml. |
|----------|-------|--------|-----|
| 41479-05 | 9     | 17     | 500 |



**Mixing glass**

Bicchieri vetro  
Becherglas  
Verre

Vaso vidrio

| art.     | Ø cm. | h. cm. | ml. |
|----------|-------|--------|-----|
| 41479-AA | 8,5   | 15     | 500 |



**Mixing glass**

Bicchieri vetro  
Becherglas  
Verre

Vaso vidrio

| art.     | Ø cm. | h. cm. | ml. |
|----------|-------|--------|-----|
| 41478-50 | 8,8   | 15     | 473 |
| 41478-35 | 8,3   | 13     | 355 |



**Mixing glass**

Bicchieri vetro  
Becherglas  
Verre

Vaso vidrio

| art.     | Ø cm. | h. cm. | ml. |
|----------|-------|--------|-----|
| 41477-50 | 9     | 15     | 473 |

With ounce markings. – Graduato in once.



**Mixing glass with lip**

Bicchiere miscelatore con becco versatore  
Rührglas mit Lippe  
Verre mélangeur avec bec verseur  
Vaso mezclador vertedor con pico

| art.     | Ø cm. | h. cm. | lt. |
|----------|-------|--------|-----|
| 41514-05 | 9     | 16,5   | 0,5 |



**Mixing glass with lip**

Bicchiere miscelatore con becco versatore  
Rührglas mit Lippe  
Verre mélangeur avec bec verseur  
Vaso mezclador vertedor con pico

| art.     | Ø cm. | h. cm. | lt.  |
|----------|-------|--------|------|
| 41514-10 | 11,5  | 19     | 0,95 |



PC

**Whiskey glass**

Bicchiere whiskey  
Whiskey Glas  
Verre à whiskey  
Vaso para whiskey

| art.     | Ø cm. | h. cm. | ml. |
|----------|-------|--------|-----|
| 44940-01 | 8,5   | 9,5    | 420 |

U.Pack 6 pcs



PC

**Juice glass**

Bicchiere succo  
Fruchtsaft-Glas  
Verre à jus  
Vaso para zumo

| art.     | Ø cm. | h. cm. | ml. |
|----------|-------|--------|-----|
| 44940-02 | 7,5   | 15,5   | 460 |

U.Pack 6 pcs



PC

**Beer glass**

Boccale birra  
Bier-Glas  
Verre à bière  
Vaso para cerveza

| art.     | Ø cm. | h. cm. | ml. |
|----------|-------|--------|-----|
| 44940-06 | 8     | 23     | 450 |

U.Pack 6 pcs



MS

**Beer glass**

Boccale birra  
Bier-Glas  
Verre à bière  
Vaso para cerveza

| art.     | Ø cm. | h. cm. | ml. |
|----------|-------|--------|-----|
| 44940-08 | 9     | 16     | 500 |

U.Pack 6 pcs



PC

**Margarita glass**  
Bicchiere margarita  
Margarita-Glas  
Verre à margarita  
Vaso margarita

| art.     | Ø cm. | h. cm. | ml. |
|----------|-------|--------|-----|
| 44940-10 | 12    | 18     | 300 |

**U.Pack 6 pcs**



PC

**Martini glass**  
Bicchiere martini  
Martini-Glas  
Verre à martini  
Vaso martini

| art.     | Ø cm. | h. cm. | ml. |
|----------|-------|--------|-----|
| 44940-11 | 12    | 17     | 240 |

**U.Pack 6 pcs**



PC

**Wine glass**  
Bicchiere vino  
Wein-Glas  
Verre à vin  
Vaso vino

| art.     | Ø cm. | h. cm. | ml. |
|----------|-------|--------|-----|
| 44940-12 | 7     | 21     | 300 |

**U.Pack 6 pcs**



PC

**Wine glass**  
Bicchiere vino  
Wein-Glas  
Verre à vin  
Vaso vino

| art.     | Ø cm. | h. cm. | ml. |
|----------|-------|--------|-----|
| 44940-13 | 7     | 19     | 200 |

**U.Pack 6 pcs**



PC

**Champagne glass**  
Bicchiere spumante  
Sekt-Glas  
Flûte  
Vaso champaña

| art.     | Ø cm. | h. cm. | ml. |
|----------|-------|--------|-----|
| 44940-14 | 5     | 22     | 180 |

**U.Pack 6 pcs**



PC

**Mixing glass**  
Bicchiere  
Glas  
Verre  
Vaso

| art.     | Ø cm. | h. cm. | ml. |
|----------|-------|--------|-----|
| 44940-16 | 9     | 16     | 540 |

**U.Pack 6 pcs**



PC

**Whiskey/rocks glass**  
Bicchiere whiskey/rocks  
Whiskey-/Rocks-Glas  
Verre à whiskey/rocks  
Vaso para whiskey/rocks

| art.     | Ø cm. | h. cm. | ml. |
|----------|-------|--------|-----|
| 44940-17 | 9     | 12     | 420 |

**U.Pack 6 pcs**



PC

**Whiskey/rocks glass**  
Bicchieri whiskey/rocks  
Whiskey-/Rocks-Glas  
Verre à whiskey/rocks  
Vaso para whiskey/rocks

| art.     | Ø cm. | h. cm. | ml. |
|----------|-------|--------|-----|
| 44940-18 | 8,5   | 11,5   | 420 |

U.Pack 6 pcs



PC

**Cooler**  
Bicchiere  
Glas  
Verre  
Vaso

| art.     | Ø cm. | h. cm. | ml. |
|----------|-------|--------|-----|
| 44940-19 | 8     | 17     | 540 |

U.Pack 6 pcs



PC

**Tumbler**  
Bicchiere  
Trinkbecher  
Gobelet  
Vaso

| art.     | Ø cm. | h. cm. | ml. |
|----------|-------|--------|-----|
| 44940-24 | 7,5   | 12,5   | 360 |
| 44940-25 | 8,0   | 13,5   | 480 |
| 44940-26 | 8,5   | 16,0   | 660 |

U.Pack 6 pcs



PC

**Tumbler**  
Bicchiere  
Trinkbecher  
Gobelet  
Vaso

| art.     | Ø cm. | h. cm. | ml. |
|----------|-------|--------|-----|
| 44940-32 | 7,5   | 12,5   | 360 |
| 44940-33 | 8,0   | 13,5   | 480 |
| 44940-34 | 8,5   | 16,0   | 660 |

U.Pack 6 pcs



SAN

**Tumbler**  
Bicchiere  
Trinkbecher  
Gobelet  
Vaso

| art.     | Ø cm. | h. cm. | ml. |
|----------|-------|--------|-----|
| 44990-15 | 5,5   | 9,5    | 150 |
| 44990-24 | 6,5   | 10,0   | 240 |
| 44990-29 | 7,0   | 11,0   | 290 |
| 44990-36 | 7,5   | 13,0   | 360 |
| 44990-48 | 8,0   | 15,0   | 480 |

U.Pack 6 pcs



PP

**Cover with spout**  
Coperchio con beccuccio  
Deckel mit Ausguss  
Couvercle avec bec  
Tapa con boquilla

| art.     | Ø cm. | U. Pack |
|----------|-------|---------|
| 44871-23 | 7     | 10      |



PC

**Water tumbler**  
Bicchiere acqua  
Wasserglas  
Verre à eau  
Vaso agua

| art.     | Ø cm. | h. cm. | ml. | U. Pack | col. |
|----------|-------|--------|-----|---------|------|
| 44871-20 | 7,0   | 7,0    | 170 | 50      | ○    |
| 44871-21 | 7,0   | 10,2   | 250 | 30      | ○    |
| 44871-22 | 7,8   | 11,4   | 350 | 30      | ○    |



NEW

PC

**Water tumbler**  
Bicchiere acqua  
Wasserglas  
Verre à eau  
Vaso agua

| art.     | Ø cm. | h. cm. | ml. | U. Pack | col. |
|----------|-------|--------|-----|---------|------|
| 44871R20 | 7,0   | 7,0    | 170 | 50      | ●    |
| 44871L20 | 7,0   | 7,0    | 170 | 50      | ●    |
| 44871G20 | 7,0   | 7,0    | 170 | 50      | ●    |
| 44871B20 | 7,0   | 7,0    | 170 | 50      | ●    |



**NEW**



**PC**

**Water tumbler**  
Bicchieri acqua  
Wasserglas  
Verre à eau  
Vaso agua

| art.     | Ø cm. | h. cm. | ml. | U. Pack | col. |
|----------|-------|--------|-----|---------|------|
| 44871R21 | 7,0   | 10,2   | 250 | 30      | ●    |
| 44871L21 | 7,0   | 10,2   | 250 | 30      | ●    |
| 44871G21 | 7,0   | 10,2   | 250 | 30      | ●    |
| 44871B21 | 7,0   | 10,2   | 250 | 30      | ●    |



**NEW**



**PC**

**Water jug**  
Caraffa  
Wasserkrug  
Crûche à eau  
Jarra

| art.     | dim. cm.  | l.  |
|----------|-----------|-----|
| 44871-28 | 12x13,8   | 0,5 |
| 44871-30 | 17,4x17   | 1,0 |
| 44871-32 | 18,7x19,8 | 1,5 |
| 44871-34 | 21,6x18,8 | 2,0 |

**Withstands temperatures/Termoresistenti da: -30° +120°C.**



**NEW**

**PC**

**Lid**  
Coperchio  
Deckel  
Couverture  
Tapa

| art.     | dim. cm. | fits/per | U. Pack |
|----------|----------|----------|---------|
| 44871-29 | 9,9x1,4  | l. 0,5   | 10      |
| 44871-31 | 11,2x1,9 | l. 1,0   | 10      |
| 44871-33 | 14x2,4   | l. 1,5   | 10      |
| 44871-35 | 15,9x2,2 | l. 2,0   | 10      |

**Withstands temperatures/Termoresistenti da: -40° +100°C.**



**MS**

**Cocktail glass**  
Bicchieri cocktail  
Cocktail Glas  
Verre à cocktail  
Vaso cocktail

| art.     | Ø cm. | h. cm. | ml. | U. Pack |
|----------|-------|--------|-----|---------|
| 44942-01 | 8     | 21     | 350 | 6       |



**MS**

**Cocktail glass**  
Bicchieri cocktail  
Cocktail Glas  
Verre à cocktail  
Vaso cocktail

| art.     | Ø cm. | h. cm. | ml. | U. Pack |
|----------|-------|--------|-----|---------|
| 44942-02 | 11    | 21     | 460 | 6       |



**MS**

**Martini glass**  
Bicchieri martini  
Martini-Glas  
Verre à martini  
Vaso martini

| art.     | Ø cm. | h. cm. | ml. | U. Pack |
|----------|-------|--------|-----|---------|
| 44942-03 | 10,5  | 20     | 340 | 6       |



**MS**

**Cocktail glass**  
Bicchieri cocktail  
Cocktail Glas  
Verre à cocktail  
Vaso cocktail

| art.     | Ø cm. | h. cm. | ml. | U. Pack |
|----------|-------|--------|-----|---------|
| 44942-04 | 7,5   | 23     | 220 | 6       |



MS

**Margarita glass**

Bicchiera margarita  
Margarita-Glas  
Verre à margarita  
Vaso margarita

| art.     | Ø cm. | h. cm. | ml. |
|----------|-------|--------|-----|
| 44942-05 | 12    | 17,5   | 340 |

U.Pack 6 pcs



SS

**Fruit basket**

Cestino agrumi  
Obstkorb  
Panier à fruits  
Cesta frutas

| art.     | Ø cm. | h. cm. |
|----------|-------|--------|
| 41611-20 | 21,5  | 20     |



**Orange juicer, chromed**

Spremiagrumi manuale, cromato  
Orangerpresse, verchromt  
Presse-agrumes, chromé  
Exprimidor de cítricos, cromado

| art.     | dim. cm. |
|----------|----------|
| 41456-02 | 18x13x46 |



SS

**Lemon squeezer**

Spremilimone  
Zitronenpresse  
Presse citron  
Exprime limones

| art.     | dim. cm. |
|----------|----------|
| 41606-00 | 12,5x6,5 |



SS

**Lemon squeezer**

Spremilimone  
Zitronenpresse  
Presse citron  
Exprime limones

| art.     | dim. cm. |
|----------|----------|
| 41606-01 | 7x8,5    |



**Lemon squeezer, aluminum**

Spremilimone, alluminio  
Zitronenpresse, aluminium  
Presse citron, alu  
Exprime limones, aluminio

| art.     | l. cm. |
|----------|--------|
| 41606-02 | 20     |



NEW

**Lemon/lime squeezer, aluminum**

Spremilimone/lima, alluminio  
Zitronen-/Limettenpresse, aluminium  
Presse citron, alu  
Exprimidor de limón/lima, aluminio

| art.     | dim. cm. |
|----------|----------|
| 41606-22 | 22x7,5   |

3 pieces, powder coated yellow and green.  
3 pezzi, verniciato a polvere giallo e verde.



**Soda siphon**

Sifone soda  
Soda Siphon  
Siphon à eau de seltz  
Sifón agua de seltz

| art.     | lt. |
|----------|-----|
| 41453-11 | 1   |



**Soda siphon**

Sifone soda  
Soda Siphon  
Siphon à eau de seltz  
Sifón agua de seltz

| art.     | lt. |
|----------|-----|
| 41465-10 | 1   |



**Soda siphon**

Sifone soda  
Soda Siphon  
Siphon à eau de seltz  
Sifón agua de seltz

| art.     | lt. |
|----------|-----|
| 41454-01 | 1   |





**2 Bottles Twist&Sparkle**

2 Bottiglie Twist&Sparkle  
2 Flaschen Twist&Sparkle  
2 Bouteilles Twist&Sparkle  
2 Bottiglie Twist&Sparkle

art. l. cm.  
41454-99 1



**Soda chargers, 10-pcs set**

Ricariche soda, 10 pezzi  
10-Stk. Sodakapseln-Packung  
Capsules à eau de seltz, set 10 pcs  
Cápsulas para agua de seltz, 10 pz

art. l. cm.  
41453-AA

**Content: 8 g of CO<sub>2</sub>. – Contenuto: 8 gr di CO<sub>2</sub>.**



**Ice pick**

Rompighiaccio  
Eisstößel  
Casse-glace  
Pico para hielo

art. l. cm.  
44105-00 23

**Wooden handle. – Manico legno.**



**Muddler, plastic**

Pestaghiaiccio, plastica  
Eiszerstosser, Kunststoff  
Pic à glace, plastique  
Pico para hielo, plástico

art. l. cm.  
41503-22 22,5



**SS**

**Muddler**

Pestaghiaiccio  
Eiszerstosser  
Pic à glace  
Pico para hielo

art. l. cm.  
41503-21 20



**Ice crusher, chromed**

Tritaghiaiccio, cromato  
Eiswolf, verchromt  
Broyer à glace, chromé  
Trituradora de hielo, cromada

art. dim. cm.  
41457-00 15x12x26



**SS**

**Ice scoop**

Sessola per ghiaccio  
Eisschaufel  
Pelle à glace  
Librador para hielo

art. ml.  
41503-00 100



**PC**

**Ice scoop**

Sessola per ghiaccio  
Eisschaufel  
Pelle à glace  
Librador para hielo

art. ml.  
14958-01 100  
14958-02 250



**SS**

**Ice spoon**

Cucchiaio ghiaccio  
Eislöffel  
Cuillère à glace  
Cuchara hielo

art. l. cm.  
12550-04 22



**PP**

**Mold for ice-balls**

Stampo sfere di ghiaccio  
Eis-Kugel-Former  
Moule pour boules de glace  
Molde bolas de hielo

art. dim. cm.  
41515-03 24x8,5

**For 3 balls ø 5,5 cm, 100 ml.**  
Per 3 sfere ø 5,5 cm da 100 ml.



**NEW**

**Mold for ice-ball, silicone**

Stampo sfera di ghiaccio, silicone  
Eis-Kugel-Former, Silikon  
Moule à boule de glace, silicone  
Molde bola de hielo, silicona

art. dim. cm.  
41515-10 6,8x7,5

**For 1 ball ø 6 cm. – Per 1 sfera ø 6 cm.**



**NEW**

**Mold for ice-balls, silicone**

Stampo sfere di ghiaccio, silicone  
Eis-Kugel-Former, Silikon  
Moule à boules de glace, silicone  
Molde bolas de hielo, silicona

art. dim. cm.  
41515-08 12x12x5

**For 4 balls ø 4,5 cm. – Per 4 sfere ø 4,5 cm.**





NEW

**Mold for ice-balls, silicone**

Stampo sfere di ghiaccio, silicone  
Eis-Kugel-Former, Silikon  
Moule à boules de glace, silicone  
Molde bolas de hielo, silicona

art. dim. cm.

41515-09 23,5x12,8x5

For 8 balls ø 4 cm. – Per 8 sfere ø 4 cm.



**Mold for ice-skulls, silicone**

Stampo teschi ghiaccio, silicone  
Eis-Schädel-Former, Silikon  
Moule à crânes de glace, silicone  
Molde de crâneos de hielo, silicona

art. dim. cm.

41515-05 11x8



NEW

**Mold for ice-cubes, silicone**

Stampo cubetti ghiaccio, silicone  
Eiswürfel-Former, Silikon  
Moule à glaçons, silicone  
Molde cubitos de hielo, silicona

art. dim. cm.

41515-20 27x14x3,5

For 21 cubes 3 cm. – Per 21 cubetti 3 cm.



NEW

**Mold for ice-cubes, silicone**

Stampo cubetti ghiaccio, silicone  
Eiswürfel-Former, Silikon  
Moule à glaçons, silicone  
Molde cubitos de hielo, silicona

art. dim. cm.

41515-21 25x12x3

For 32 cubes 2,5 cm. – Per 32 cubetti 2,5 cm.



**Mold for ice-diamonds, silicone**

Stampo diamanti ghiaccio, silicone  
Eis-Diamant-Former, Silikon  
Moule à diamants de glace, silicone  
Molde de diamante de hielo, silicona

art. dim. cm.

41515-07 12x12



NEW

**Mold for ice-balls, silicone**

Stampo sfere di ghiaccio, silicone  
Eis-Kugel-Former, Silikon  
Moule à boules de glace, silicone  
Molde bolas de hielo, silicona

art. dim. cm.

41515-22 24x13x2

For 40 balls ø 1 cm. – Per 40 sfere ø 1 cm.





SS

**Ice tong**

Molla ghiaccio  
Eiszange  
Pince à glace  
Pinza hielo

| art.     | l. cm. | col. |
|----------|--------|------|
| 41518G12 | 16     | ●    |
| 41518C12 | 16     | ●    |
| 41518B12 | 16     | ●    |



**Ice bucket with tong**

Secchio ghiaccio e pinza  
Eiseimer mit Eiszange  
Seau à glace avec pince  
Cubo hielo con pinza

| art.     | Ø mm. | h. cm. | lt. |
|----------|-------|--------|-----|
| 41513-13 | 14    | 22     | 1,3 |

**Noble plastic jacket highly chrome plated with special insulated plastic insert.**

Camicia in materiale plastico, finitura cromata lucida con speciale inserto termico.



**Ice bucket, plastic**

Secchio ghiaccio, plastica  
Eiseimer, Kunststoff  
Seau à glace, plastique  
Cubo hielo, plástico

| art.     | Ø mm. | h. cm. | lt. |
|----------|-------|--------|-----|
| 41512-15 | 15    | 15     | 1,5 |
| 41512-30 | 20    | 18     | 3,0 |

**Satin metal look with highly polished edge. Special insulated plastic insert.**

Finitura effetto metallo satinato, bordo lucido. Speciale inserto termico.



PP

SAN

**Ice box**

Secchio ghiaccio  
Eisbox  
Seau à glaçons  
Cubitera

| art.     | dim. cm. | lt. |
|----------|----------|-----|
| 41512-50 | 27x27x15 | 5,4 |

**With drainer. – Con griglia.**



SS

**Ice bucket**

Secchio ghiaccio  
Eisbehälter  
Seau à glace  
Cubitera hielo

| art.     | Ø cm. | h. cm. |
|----------|-------|--------|
| 46116-15 | 12,5  | 13     |



SS

**Ice bucket**

Secchiello ghiaccio  
Eisbehälter  
Seau à glace  
Cubitera hielo

| art.     | Ø cm. | h. cm. | lt. | col. |
|----------|-------|--------|-----|------|
| 41513G20 | 15    | 14     | 2   | ●    |
| 41513C20 | 15    | 14     | 2   | ●    |
| 41513B20 | 15    | 14     | 2   | ●    |



**Bar organizer**

Porta oggetti da bar  
Bar-Behälter  
Présentoir de bar  
Dispensador bar

| art.     | dim. cm.   |
|----------|------------|
| 44102-24 | 24x14,5x11 |



SS

**Bar set, 5 pieces**

Set da bar, 5 pezzi  
Bar-Set, 5-tlg.  
Set 5 pièces à cocktail  
Juego 5 piezas cóctel

| art.     |
|----------|
| 41510-05 |



**Flair bottle**

Flair bottle  
Flair bottle  
Flair bottle  
Flair bottle

| art.     | lt.  | col. |
|----------|------|------|
| 44108-01 | 0,75 | ○    |
| 44108-02 | 0,75 | ●    |



NEW

ABS

**Smoking gun**

Affumicatore  
Räuchergerät  
Pistolet à fumer  
Ahumador aromatizador

| art.     | dim. cm.      |
|----------|---------------|
| 49923-00 | 16,2x5,5x12,5 |

**DC6V - 3,0L/min. Ideal for flavoring and smoking liquid and solid products, such as: cocktails, vegetables, meat and fish.** – Ideale per aromatizzare e affumicare prodotti liquidi e solidi, come: cocktail, verdure, carne e pesce.



NEW

**Cocktail cover**

Cloche per affumicatore  
Cocktail Räucherglocke  
Cloche à fumée  
Campana para ahumado

| art.     | Ø cm. | h. cm. |
|----------|-------|--------|
| 49923-01 | 12    | 11     |
| 49923-02 | 12    | 16     |

**Wood base ø 15 cm.** – Base legno ø 15 cm.



**Skull dash bottle**

Bottiglia angostura teschio  
Schädel Dash Bottle  
Dash bottle crâne  
Dash bottle cráneo

| art.     | ml. |
|----------|-----|
| 41680-03 | 30  |
| 41680-06 | 60  |
| 41680-12 | 120 |



**Atomizer dash bottle**

Bottiglia angostura spray  
Bitter Flasche Atomizer  
Vaporisateur d'angostura  
Botella angostrura spray

| art.     | ml. |
|----------|-----|
| 41681-10 | 100 |



NEW

**Atomizer dash bottle**

Bottiglia angostura spray  
Bitter Flasche Atomizer  
Vaporisateur d'angostura  
Botella angostrura spray

| art.     | h. cm. | ml. |
|----------|--------|-----|
| 41681-11 | 15     | 50  |



NEW

**Atomizer dash bottle**

Bottiglia angostura spray  
Bitter Flasche Atomizer  
Vaporisateur d'angostura  
Botella angostrura spray

| art.     | Ø cm. | h. cm. | ml. | col. |
|----------|-------|--------|-----|------|
| 41681-12 | 7     | 10     | 100 | ●    |



**Dash bottle**

Bottiglia angostura  
Bitter Flasche  
Dash bottle  
Botella angostrura

| art.     | ml. |
|----------|-----|
| 41681-06 | 150 |





**Dash Bottle**

Bottiglia angostura  
Bitter Flasche  
Dash Bottle

Botella Angostrura

| art.     | dim. cm.   | ml. |
|----------|------------|-----|
| 41681-01 | 6,5x6,5x10 | 100 |



**Dash Bottle**

Bottiglia angostura  
Bitter Flasche  
Dash Bottle

Botella Angostrura

| art.     | Ø cm. | h. cm. | ml. |
|----------|-------|--------|-----|
| 41681-03 | 8,5   | 15     | 280 |



**Dash Bottle**

Bottiglia angostura  
Bitter Flasche  
Dash Bottle

Botella Angostrura

| art.     | dim. cm. | ml. |
|----------|----------|-----|
| 41681-02 | 6x5x15   | 200 |

**Without pourer. – Senza dosatore.**



**Dash Bottle**

Bottiglia angostura  
Bitter Flasche  
Dash Bottle

Botella Angostrura

| art.     | Ø cm. | h. cm. | ml. |
|----------|-------|--------|-----|
| 41681-04 | 6,2   | 10     | 100 |

**Without pourer. – Senza dosatore.**



**Dash bottle pourer**

Tappo versatore  
Ausgiesser  
Bouchon verseur

Tapón vertedor

| art.     |
|----------|
| 41681-99 |



**PP**

**Store & pour container**

Contentitore versatore  
Dosier-Vorratsbehälter, komplett  
Bouteille verseuse  
Recipiente vertedor

| art.     | Ø cm. | h. cm. | lt. | col. |
|----------|-------|--------|-----|------|
| 44106W05 | 9,0   | 26     | 0,5 | ○    |
| 44106W10 | 9,0   | 33     | 1,0 | ○    |
| 44106W20 | 12,5  | 35     | 2,0 | ○    |
| 44106W25 | 12,5  | 39     | 2,5 | ○    |



**PP**

**Store & pour container**

Contentitore versatore  
Dosier-Vorratsbehälter, komplett  
Bouteille verseuse  
Recipiente vertedor

| art.     | Ø cm. | h. cm. | lt. | col. |
|----------|-------|--------|-----|------|
| 44106G05 | 9,0   | 26     | 0,5 | ●    |
| 44106G10 | 9,0   | 33     | 1,0 | ●    |
| 44106G20 | 12,5  | 35     | 2,0 | ●    |
| 44106G25 | 12,5  | 39     | 2,5 | ●    |



**PP**

**Store & pour container**

Contentitore versatore  
Dosier-Vorratsbehälter, komplett  
Bouteille verseuse  
Recipiente vertedor

| art.     | Ø cm. | h. cm. | lt. | col. |
|----------|-------|--------|-----|------|
| 44106Y05 | 9,0   | 26     | 0,5 | ●    |
| 44106Y10 | 9,0   | 33     | 1,0 | ●    |
| 44106Y20 | 12,5  | 35     | 2,0 | ●    |
| 44106Y25 | 12,5  | 39     | 2,5 | ●    |



PP

**Store & pour container**

Contentore versatore  
Dosier-Vorratsbehälter, komplett  
Bouteille verseuse  
Recipiente vertedor

| art.     | Ø cm. | h. cm. | lt. | col. |
|----------|-------|--------|-----|------|
| 44106R05 | 9,0   | 26     | 0,5 | ●    |
| 44106R10 | 9,0   | 33     | 1,0 | ●    |
| 44106R20 | 12,5  | 35     | 2,0 | ●    |
| 44106R25 | 12,5  | 39     | 2,5 | ●    |



PP

**Store & pour container**

Contentore versatore  
Dosier-Vorratsbehälter, komplett  
Bouteille verseuse  
Recipiente vertedor

| art.     | Ø cm. | h. cm. | lt. | col. |
|----------|-------|--------|-----|------|
| 44106O05 | 9,0   | 26     | 0,5 | ●    |
| 44106O10 | 9,0   | 33     | 1,0 | ●    |
| 44106O20 | 12,5  | 35     | 2,0 | ●    |
| 44106O25 | 12,5  | 39     | 2,5 | ●    |



PP

**Store & pour container**

Contentore versatore  
Dosier-Vorratsbehälter, komplett  
Bouteille verseuse  
Recipiente vertedor

| art.     | Ø cm. | h. cm. | lt. | col. |
|----------|-------|--------|-----|------|
| 44106B05 | 9,0   | 26     | 0,5 | ●    |
| 44106B10 | 9,0   | 33     | 1,0 | ●    |
| 44106B20 | 12,5  | 35     | 2,0 | ●    |
| 44106B25 | 12,5  | 39     | 2,5 | ●    |



PP

**Storage canister**

Contentore di riserva  
Vorratsbehälter  
Réipient réserve  
Recipiente reserva

| art.     | Ø cm. | h. cm. | lt. | col. |
|----------|-------|--------|-----|------|
| 44107W05 | 9,0   | 9,5    | 0,5 | ○    |
| 44107W10 | 9,0   | 16     | 1,0 | ○    |
| 44107W20 | 12,5  | 20     | 2,0 | ○    |
| 44107W25 | 12,5  | 23     | 2,5 | ○    |



PP

**Storage canister**

Contentore di riserva  
Vorratsbehälter  
Réipient réserve  
Recipiente reserva

| art.     | Ø cm. | h. cm. | lt. | col. |
|----------|-------|--------|-----|------|
| 44107G05 | 9,0   | 9,5    | 0,5 | ●    |
| 44107G10 | 9,0   | 16     | 1,0 | ●    |
| 44107G20 | 12,5  | 20     | 2,0 | ●    |
| 44107G25 | 12,5  | 23     | 2,5 | ●    |



PP

**Storage canister**

Contentore di riserva  
Vorratsbehälter  
Réipient réserve  
Recipiente reserva

| art.     | Ø cm. | h. cm. | lt. | col. |
|----------|-------|--------|-----|------|
| 44107Y05 | 9,0   | 9,5    | 0,5 | ●    |
| 44107Y10 | 9,0   | 16     | 1,0 | ●    |
| 44107Y20 | 12,5  | 20     | 2,0 | ●    |
| 44107Y25 | 12,5  | 23     | 2,5 | ●    |



PP

**Storage canister**

Contentore di riserva  
Vorratsbehälter  
Réipient réserve  
Recipiente reserva

| art.     | Ø cm. | h. cm. | lt. | col. |
|----------|-------|--------|-----|------|
| 44107R05 | 9,0   | 9,5    | 0,5 | ●    |
| 44107R10 | 9,0   | 16     | 1,0 | ●    |
| 44107R20 | 12,5  | 20     | 2,0 | ●    |
| 44107R25 | 12,5  | 23     | 2,5 | ●    |



PP

**Storage canister**

Contentore di riserva  
Vorratsbehälter  
Réipient réserve  
Recipiente reserva

| art.     | Ø cm. | h. cm. | lt. | col. |
|----------|-------|--------|-----|------|
| 44107O05 | 9,0   | 9,5    | 0,5 | ●    |
| 44107O10 | 9,0   | 16     | 1,0 | ●    |
| 44107O20 | 12,5  | 20     | 2,0 | ●    |
| 44107O25 | 12,5  | 23     | 2,5 | ●    |



PP

**Storage canister**

Contentore di riserva  
Vorratsbehälter  
Réipient réserve  
Recipiente reserva

| art.     | Ø cm. | h. cm. | lt. | col. |
|----------|-------|--------|-----|------|
| 44107B05 | 9,0   | 9,5    | 0,5 | ●    |
| 44107B10 | 9,0   | 16     | 1,0 | ●    |
| 44107B20 | 12,5  | 20     | 2,0 | ●    |
| 44107B25 | 12,5  | 23     | 2,5 | ●    |





**Pouring container cap**

Tappo per versatore  
Dosier-Behälterstopfen  
Bouchon à bouteille verseuse  
Tapón para recipiente vertedor

| art.     | pcs/pz |
|----------|--------|
| 44106-12 | 12     |



**ABS**

**Condiment holder**

Portacondimenti  
Bar-Beilagenbehälter  
Boîte à condiments  
Caja condimentos

| art.     | dim. cm. | comp. |
|----------|----------|-------|
| 44103-03 | 49x15x9  | 3     |
| 44103-04 | 49x15x9  | 4     |
| 44103-06 | 49x15x9  | 6     |



**SS**

**Condiment holder**

Portacondimenti  
Bar-Beilagenbehälter  
Boîte à condiments  
Caja condimentos

| art.     | dim. cm. | comp. |
|----------|----------|-------|
| 41782-04 | 32x16x10 | 4     |
| 41782-05 | 39x16x10 | 5     |
| 41782-06 | 47x16x10 | 6     |



**Glass rimmer**

Bordatore bicchieri  
Bar-Kombination Salz-/Zuckerumrander  
Système de givrage de verres  
Ribeteador de vasos

| art.     | Ø cm. |
|----------|-------|
| 44101-03 | 15,5  |



**PE**

**Bar liner**

Tappeto sottobicchieri  
Gläsermatte  
Revêtement de bar  
Tapete para vasos

| art.     | dim. cm. |
|----------|----------|
| 44099-03 | 60x1300  |

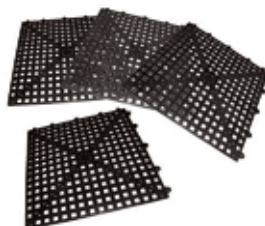

**Bar mat, non-slip**

Tappeto antiscivolo componibile  
Gläserabstellmatte, rutschfest  
Tapis antidérapant, composable  
Alfombra antiderrapante, componible

| art.     | dim. cm. |
|----------|----------|
| 44100-04 | 30x30    |



**Bar runner**

Tappetino bar  
Gläserabstellmatte  
Tapis à verres  
Tapete para vasos

| art.     | dim. cm. |
|----------|----------|
| 44100-01 | 68x8     |
| 44100-02 | 45x30    |



**Barman's set, 20 pcs**

Valigia Barman, 20 pz

Barman-Koffer, 20 Stk.

Mallette de barman, 20 pièces

Alfombra, 20 piezas

| art.     | des.                         |
|----------|------------------------------|
| 14480-20 | Comprende/includes:          |
| 41479-05 | boston shaker                |
| 41480-05 | shaker                       |
| 41503-22 | pestello/ice beater          |
| 41595-20 | cucchiaio magico/magic spoon |
| 41603-00 | colino/strainer              |
| 41604-00 | misurino/measuring cup       |
| 41605-00 | miscelatore/mixing spoon     |
| 41606-00 | spremilimone/lemon squeezer  |
| 41606-01 | spremilimone/lemon squeezer  |
| 41606-02 | spremilime/lime squeezer     |

| art.     | des.                               |
|----------|------------------------------------|
| 41608-04 | tappo/champagne stopper            |
| 41699-06 | cavatappi/corkscrew                |
| 44058-10 | tappo dosatore/dispenser plug 10ml |
| 48280-02 | levacapsule/bottle opener          |
| 48280-97 | coltello barman/barman knife       |
| 48280-92 | rigalimoni/lemon striper           |
| 48280-96 | pelarance/orange peeler            |
| 12550-04 | cucchiaio ghiaccio/ice spoon       |
| 12550-36 | cucchiaio bibita/cocktail spoon    |
| 12550-55 | molla ghiaccio/ice tong            |



NEW

**Barman apron**

Grebiule barman

Barman Schurz

Tablier barman

Mandil barman

| art.     | dim. cm. |
|----------|----------|
| 48543-01 | 70x40    |

65% polyester/poliestere. – 35% cotton/cotone. 195 g/mq.



NEW

**Barman apron**

Grebiule barman

Barman Schurz

Tablier barman

Mandil barman

| art.     | dim. cm. |
|----------|----------|
| 48543-02 | 70x40    |

65% polyester/poliestere. – 35% cotton/cotone. 195 g/mq.





SS

**Speed rack**

Rastrelliera  
Flaschenregal  
Rack à bouteilles  
Estantería bar para botellas

| art.     | dim. cm.      | bot. |
|----------|---------------|------|
| 44060-50 | 56x10,5x15,5  | 6    |
| 44060-80 | 81x10,5x15,5  | 8    |
| 44060-99 | 107x10,5x15,5 | 10   |



SS

**Speed rack**

Rastrelliera  
Flaschenregal  
Rack à bouteilles  
Estantería bar para botellas

| art.     | dim. cm.   | bot. |
|----------|------------|------|
| 44060-51 | 56x21x15,5 | 2x 6 |



SS

**Glass shelf rack**

Rastrelliera, fissaggio sospeso  
Gläserhalter Regalmontage  
Rack à verres fixation suspendue  
Rack de copas, fijación techo

| art.     | dim. cm.    |
|----------|-------------|
| 44060-01 | 45x31,6x5,5 |



SS

**Glass wall rack**

Rastrelliera, fissaggio murale  
Gläserhalter Wandmontage  
Rack à verres fixation murale  
Rack de copas, fijación mural

| art.     | dim. cm.    |
|----------|-------------|
| 44060-02 | 45x31,6x5,6 |



SS

**Glass cleaning brush**

Lavabicchieri  
Gläserpüleri  
Brosse lave-verres  
Cepillo lavavasos

| art.     | dim. cm. |
|----------|----------|
| 44135-02 | 38x18x29 |



**Glass cleaning brush, nylon**

Spazzole lavabicchieri, nylon  
Bierglasbürstenständer, nylon  
Brosse lave-verres, nylon  
Cepillo lavavasos, nilón

| art.     | h. cm. |
|----------|--------|
| 44130-02 | 16,5   |
| 44130-03 | 21,5   |



**Glass cleaning brush, nylon-aluminum**

Spazzola lavabicchieri, nylon-alluminio  
Bierglasbürstenständer, Nylon-Aluminium  
Brosse lave-verres, nylon-alu  
Cepillo lavavasos, nilón-aluminio

| art.     | Ø cm. | h. cm. |
|----------|-------|--------|
| 44130-01 | 15    | 19     |



**Aluminum wall mounter bottle rack**

Supporto a parete, alluminio  
Alu-Wandständer  
Support pour bouteilles en aluminium  
Soporte mural, aluminio

| art.     | l. cm. | bot. |
|----------|--------|------|
| 44056-04 | 41     | 4    |
| 44056-06 | 67     | 6    |

**Dispensers not included. – Dosatori non inclusi.**



**Revolving bottle rack**

Supporto rotante da banco  
Theken-Drehständer vollständig  
Support rotatif de comptoir  
Soporte giratorio

| art.     | h. cm. | bot. |
|----------|--------|------|
| 44057-04 | 70     | 4    |
| 44057-06 | 70     | 6    |

**Dispensers not included. – Dosatori non inclusi.**





**Standard aluminum support**

Supporto bottiglia, alluminio  
Alu-Standard Ständer,  
Support en aluminium  
Soporte de botella, aluminio

| art.     | col. |
|----------|------|
| 44056-01 | ●    |
| 44056-11 | ●    |
| 44056-21 | ●    |

**Universal fitting, shelf or wall mounting.**  
Fissaggio universale, a ripiano o parete.



**Chrome plated dispenser**

Dosatore cromato  
Verchromter Dosierer  
Doseur chromé  
Dosificador cromado

| art.     | ml. |
|----------|-----|
| 44055-10 | 10  |
| 44055-50 | 50  |



**Chrome plated dispenser**

Dosatore cromato  
Verchromter Dosierer  
Doseur chromé  
Dosificador cromado

| art.     | ml. |
|----------|-----|
| 44055-20 | 20  |
| 44055-25 | 25  |
| 44055-30 | 30  |
| 44055-35 | 35  |
| 44055-40 | 40  |



**Dispenser**

Dosatore  
Dosierer  
Doseur  
Dosificador

| art.     | ml. | col. |
|----------|-----|------|
| 44055G30 | 30  | ●    |
| 44055G40 | 40  | ●    |
| 44055C30 | 30  | ●    |
| 44055C40 | 40  | ●    |



**Automatic dispenser plug**

Tappo dosatore automatico  
Automatischer Portionierer  
Bouchon doseur automatique  
Bola dosificadora

| art.     | ml. |
|----------|-----|
| 44058-20 | 20  |
| 44058-25 | 25  |
| 44058-30 | 30  |



**Automatic dispenser plug**

Tappo dosatore automatico  
Automatischer Portionierer  
Bouchon doseur automatique  
Bola dosificadora

| art.     | ml. |
|----------|-----|
| 44058-10 | 10  |
| 44058-40 | 40  |
| 44058-50 | 50  |



SS

**Bottle pourer with stopper**

Tappo versatore con chiusura  
Ausgießer mit Kappe  
Bouchon avec clapet  
Tapón vertedor con clerre

| art.     | pcs/pz |
|----------|--------|
| 44111-02 | 2      |

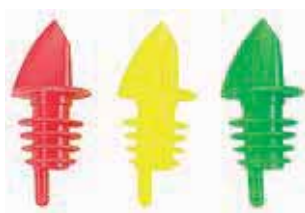

**Free flow pourer**

Tappo versatore continuo  
Permanentausgießer  
Bouchon verseur continu  
Vertedor continuo

| art.     | pcs/pz | col. |
|----------|--------|------|
| 44110-01 | 12     | ●    |
| 44110-02 | 12     | ●    |
| 44110-03 | 12     | ●    |



**Free flow pourer**

Tappo versatore continuo  
Permanentausgießer  
Bouchon verseur continu  
Vertedor continuo

| art.     | pcs/pz | col. |
|----------|--------|------|
| 44110-04 | 12     | ●    |
| 44110-05 | 12     | ○    |
| 44110-06 | 12     | ●    |





**Free flow pourer**

Tappo versatore continuo  
Permanentausgiesser  
Bouchon verseur continu  
Vertedor continuo

| art.     | pcs/pz |
|----------|--------|
| 44110-00 | 12     |



**Measuring pourer**

Tappo versatore dosatore  
Dosierausgiesser  
Bouchon verseur doseur  
Tapón vertedor dosificador

| art.     | U. Pack | col. |
|----------|---------|------|
| 44119-01 | 6       | ●    |
| 44119-02 | 6       | ●    |
| 44119-03 | 6       | ●    |
| 44119-04 | 6       | ●    |
| 44119-06 | 6       | ●    |



**Measuring pourer**

Tappo versatore dosatore  
Dosierausgiesser  
Bouchon verseur doseur  
Tapón vertedor dosificador

| art.     |
|----------|
| 44114-01 |
| 44114-02 |
| 44114-03 |

SS



**Measured pourer**

Tappo metrico  
Portioniererausgiesser  
Bouchon doseur  
Caños dosificador

| art.     | ml. | U. Pack | col. |
|----------|-----|---------|------|
| 44118-10 | 10  | 6       | ●    |
| 44118-20 | 20  | 6       | ●    |
| 44118-25 | 25  | 6       | ●    |
| 44118-30 | 30  | 6       | ●    |



**Measured pourer**

Tappo metrico  
Portioniererausgiesser  
Bouchon doseur  
Caños dosificador

| art.     | ml. | U. Pack | col. |
|----------|-----|---------|------|
| 44118-35 | 35  | 6       | ●    |
| 44118-40 | 40  | 6       | ●    |
| 44118-50 | 50  | 6       | ○    |



**Whiskey pourer**

Tappo versatore  
Ausgiesser  
Bouchon verseur  
Vertedor

| art.     | pcs/pz | col. |
|----------|--------|------|
| 44112-01 | 12     | ●    |
| 44112-02 | 12     | ○    |



**Champagne stopper**

Tappo spumante  
Sektflaschenstopfen  
Bouchon à champagne  
Tapón Champaña

| art.     |
|----------|
| 41608-20 |



**Champagne stopper**

Tappo spumante  
Sektflaschenstopfen  
Bouchon à champagne  
Tapón Champaña

| art.     |
|----------|
| 41608-04 |



**Champagne stopper**

Tappo spumante  
Sektflaschenstopfen  
Bouchon à champagne  
Tapón Champaña

| art.     |
|----------|
| 41608-08 |



**Champagne stopper**

Tappo spumante  
Sektflaschenstopfen  
Bouchon à champagne  
Tapón Champaña

| art.     |
|----------|
| 41608-00 |



**Champagne stopper**

Tappo spumante  
Sektflaschenstopfen  
Bouchon à champagne  
Tapón Champaña

| art.     |
|----------|
| 46796-00 |



**Wine stopper**

Tappo vino  
Weinflaschenstopfen  
Bouchon à vin  
Tapón vino

| art.     |
|----------|
| 41608-03 |

SS

SS

SS

SS

SS



**Foil cutter**

Taglia capsula  
Folienschneider  
Coupe-capsules  
Cortacápsulas

art.

49858-07



**Winged corkscrew**

Cavatappi a doppia leva  
Korkenzieher mit Doppelhebel  
Tire-bouchon à double levier  
Sacacorchos a doble palanca

art.

41699-10



**Winged corkscrew**

Cavatappi a doppia leva  
Korkenzieher mit Doppelhebel  
Tire-bouchon à double levier  
Sacacorchos a doble palanca

art.

41699-11



**Waiter's corkscrew**

Cavatappi cameriere  
Kellner Korkenzieher  
Tire-bouchon sommelier  
Sacacorchos camarero

art.

41699-20



**Waiter's corkscrew**

Cavatappi cameriere  
Kellner Korkenzieher  
Tire-bouchon sommelier  
Sacacorchos camarero

art.

41699-06



**Lever corkscrew**

Cavatappi a leva  
Korkenzieher  
Tire-bouchon  
Sacachorcos

art.

49858-01



**Lever corkscrew**

Cavatappi a leva  
Korkenzieher  
Tire-bouchon  
Sacachorcos

art.

49858-00



**Waiter's corkscrew case**

Valigetta cameriere  
Kellner Korkenzieher-Koffer  
Mallette tire-bouchon sommelier  
Maletín sacacorchos sumiller

art.

49858-06



**Wall mounted uncorking machine**

Cavatappi da parete  
Wand-Korkenzieher  
Tire-bouchon à paroi  
Sacacorchos mural

art.

49859-00





**Bottle opener with collector box**

Levacapsule con contenitore di raccolta  
Flaschenöffner mit Sammelbehälter  
Décapsuleur avec récipient de récupération  
Abridor de botellas + caja de recuperación

| art.     | dim. cm.    |
|----------|-------------|
| 48223-00 | 10,5x7,2x30 |



**SS**

**Bottle opener**

Levacapsule  
Flaschenöffner  
Décapsuleur  
Abrebotellas

| art.     | dim. cm. | col. |
|----------|----------|------|
| 41699-18 | 18x4     | ●    |
| 41699G18 | 18x4     | ●    |
| 41699C18 | 18x4     | ●    |
| 41699B18 | 18x4     | ●    |



**SS**

**Bottle opener**

Levacapsule  
Flaschenöffner  
Décapsuleur  
Abrebotellas

| art.     | dim. cm. |
|----------|----------|
| 41699-12 | 11x4     |



**SS**

**Bottle opener**

Levacapsule  
Flaschenöffner  
Décapsuleur  
Abrebotellas

| art.     | dim. cm. |
|----------|----------|
| 41699-04 | 11x4     |



**Bar blade holster with belt clip**

Fondina per levacapsule  
Flaschenöffner-Halter  
Etui pour décapsuleur  
Funda para abrebotellas

| art.     | dim. cm. |
|----------|----------|
| 41699-13 | 11x4     |



**Bottle opener, nickelplated**

Levacapsule nichelato  
Flaschenöffner, vernickelt  
Décapsuleur, nickelé  
Abrebotellas, niquelado

| art.     |
|----------|
| 41699-03 |



**SS**

**Etlund**

**Can punch and bottle opener**

Apriscatole/levacapsule  
Dosen-/Flaschenöffner  
Ouvre-boîte/décapsuleur  
Abrelatas/botellas

| art.     |
|----------|
| 49860-00 |



**SS**

**ABS**

**Vacuum pump wine preserver + 2 stoppers**

Pompa sottovuoto per vino + 2 tappi  
Wein-Vakuum-Pumpe + 2 Stopfen  
Pompe à vide d'air + 2 bouchons  
Bomba vacío vino + 2 tapones

| art.     | des.             |
|----------|------------------|
| 41500-00 | -                |
| 41500-AA | 2 Stoppers/Tappi |



**PC**

**Glass clip holder**

Clip reggibicchieri  
Glashalter  
Clip porte-verre  
Soporte para vidrio

| art.     | U. Pack |
|----------|---------|
| 44048-99 | 100     |



**B**

**Noshikushi skewers**

Spiedini noshikushi  
Noshikushi Spieß  
Brochettes noshikushi  
Pinchos noshikushi

| art.     | l. cm. | pcs/pz |
|----------|--------|--------|
| 48300-42 | 10,5   | 100    |





W

**Toothpicks**  
Stuzzicadenti  
Zahnstocher  
Cure-dents  
Palillos

| art.     | l. cm. | pcs/pz |
|----------|--------|--------|
| 48306-01 | 9      | 1000   |

**Birch, double pointed, individually wrapped.**  
Betulla, 2 punte, imbastati singolarmente.



B

**Tepokushi skewers**  
Spiedini tepokushi  
Tepokushi Spieße  
Brochettes tepokushi  
Pinchos tepokushi

| art.     | l. cm. | pcs/pz |
|----------|--------|--------|
| 48300-43 | 9      | 100    |
| 48300-33 | 15     | 100    |

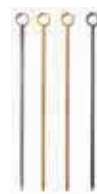

SS

**Cocktail picks, 4 pcs**  
Spiedini cocktail, 4 pz  
Cocktailspiesse, 4 Stk  
Brochettes, 4 pièces  
Palos, 4 piezas

| art.     | l. cm. | col. |
|----------|--------|------|
| 41492-00 | 10     | ●    |
| 41492G00 | 10     | ●    |
| 41492C00 | 10     | ●    |
| 41492B00 | 10     | ●    |



PS

**Spits, disposable**  
Spiedini, monouso  
Fleischspieße, einweg  
Brochettes, usage unique  
Palos, desechables

| art.     | l. cm. | pcs/pz |
|----------|--------|--------|
| 48364-09 | 9      | 500    |
| 48364-12 | 12     | 500    |



PS

**Forks, disposable**  
Forchettine monouso  
Gabeln, einweg  
Fourchettes, usage unique  
Tenedores, desechables

| art.     | l. cm. | pcs/pz |
|----------|--------|--------|
| 48362-01 | 8,5    | 500    |



PS

**Spoons, disposable**  
Cucchiaini monouso  
Löffel, einweg  
Cuillères, usage unique  
Cucharitas, desechables

| art.     | l. cm. | pcs/pz |
|----------|--------|--------|
| 48363-01 | 8,5    | 500    |



# BAR HAPPY HOUR

APPETIZERS  
AMUSE-BOUCHE



SS

**Snack holder**  
Porta snack  
Snack-Behälter  
Conteneur à snack  
Contenedor para snack

| art.     | Ø cm. | h. cm. | lt.  |
|----------|-------|--------|------|
| 41524-09 | 9     | 8,5    | 0,33 |



SS

**Snack holder, 4 pcs**  
Porta snack, 4 pz  
Snack-Behälter, 4 Stk  
Conteneur à snack, 4 pcs  
Contenedor para snack, 4 pz

| art.     | Ø cm. | h. cm. | lt.  |
|----------|-------|--------|------|
| 41524-04 | 7     | 6,5    | 0,15 |



SS

**Snack holder**  
Porta snack  
Snack-Behälter  
Conteneur à snack  
Contenedor para snack

| art.     | dim. cm.   |
|----------|------------|
| 41527-12 | 10x8,5x6,5 |
| 41527-13 | 13x10,5x9  |



SS

**Snack holder**  
Porta snack  
Snack-Behälter  
Conteneur à snack  
Contenedor para snack

| art.     | dim. cm.      |
|----------|---------------|
| 41527-10 | 21,5x10,5x4,5 |
| 41527-11 | 26x13x5       |



SS

**Snack holder**  
Porta snack  
Snack-Behälter  
Conteneur à snack  
Contenedor para snack

| art.     | Ø cm. | h. cm. |
|----------|-------|--------|
| 41523-08 | 8     | 7,5    |
| 41523-09 | 9     | 8,5    |



SS

**Snack holder**  
Mini tegame  
Mini-Servierfanne  
Conteneur à snack  
Contenedor para snack

| art.     | dim. cm.     | lt. |
|----------|--------------|-----|
| 41522-14 | 14,5x9,5x4,5 | 0,5 |



SS  
PVD

**Snack holder**  
Porta snack  
Snack-Behälter  
Conteneur à snack  
Contenedor para snack

| art.     | dim. cm.      | col. |
|----------|---------------|------|
| 41527G10 | 21,5x10,5x4,5 | ●    |
| 41527G11 | 26x13x5       | ●    |



SS  
PVD

**Snack holder**  
Porta snack  
Snack-Behälter  
Conteneur à snack  
Contenedor para snack

| art.     | dim. cm.   | col. |
|----------|------------|------|
| 41527G12 | 10x8,5x6,5 | ●    |
| 41527G13 | 13x10,5x9  | ●    |



SS  
PVD

**Snack holder**  
Porta snack  
Snack-Behälter  
Conteneur à snack  
Contenedor para snack

| art.     | Ø cm. | h. cm. | col. |
|----------|-------|--------|------|
| 41523G08 | 8     | 7,5    | ●    |
| 41523G09 | 9     | 8,5    | ●    |



SS

**Snack holder**  
Porta snack  
Snack-Behälter  
Conteneur à snack  
Contenedor para snack

| art.     | Ø cm. | h. cm. | lt.  |
|----------|-------|--------|------|
| 41524-10 | 9,5   | 11,5   | 0,45 |



SS

**Snack holder**  
Porta snack  
Snack-Behälter  
Conteneur à snack  
Contenedor para snack

| art.     | Ø cm. | h. cm. | lt.  |
|----------|-------|--------|------|
| 41524-11 | 8,5   | 8,5    | 0,35 |



SS

**Snack holder**  
Porta snack  
Snack-Behälter  
Conteneur à snack  
Contenedor para snack

| art.     | Ø cm. | h. cm. | lt.  |
|----------|-------|--------|------|
| 41524-12 | 8,5   | 8,5    | 0,35 |



SS  
PVD

**Snack holder**  
Porta snack  
Snack-Behälter  
Conteneur à snack  
Contenedor para snack

| art.     | Ø cm. | h. cm. | lt.  | col. |
|----------|-------|--------|------|------|
| 41524C10 | 9,5   | 11,5   | 0,45 | ●    |



SS  
PVD

**Snack holder**  
Porta snack  
Snack-Behälter  
Conteneur à snack  
Contenedor para snack

| art.     | Ø cm. | h. cm. | lt.  | col. |
|----------|-------|--------|------|------|
| 41524C11 | 8,5   | 8,5    | 0,35 | ●    |



SS  
PVD

**Snack holder**  
Porta snack  
Snack-Behälter  
Conteneur à snack  
Contenedor para snack

| art.     | Ø cm. | h. cm. | lt.  | col. |
|----------|-------|--------|------|------|
| 41524C12 | 8,5   | 8,5    | 0,35 | ●    |



W

**5 pcs tasting/dessert set**  
Set 5 pz aperitivo/degustazione  
5 Stück Verkostung/Dessert Set  
Set 5 pcs dégustation/dessert  
Juego de degustación/postre 5 pz

| art.     | dim. cm. | ml.  |
|----------|----------|------|
| 41205-07 | 42x9x1,8 | 4x68 |



W

**4 pcs canning Jar set**  
Set 4 pz Barattoli degustazione  
4 Stück Verkostung-Gläser Set  
Set 4 pcs dégustation/dessert  
Juego de degustación/postre 4 pz

| art.     | dim. cm.  | ml.   |
|----------|-----------|-------|
| 41205-08 | 27,5x11x4 | 3x200 |



W

**7 pcs canning Jar set**  
Set 7 pz Barattoli degustazione  
5 Stück Verkostung-Gläser Set  
Set 7 pcs dégustation/dessert  
Juego de degustación/postre 5 pz

| art.     | dim. cm. | ml.   |
|----------|----------|-------|
| 41205-09 | 43x10x3  | 6x100 |



**AR**

**5 pcs tasting/dessert set**  
Set 5 pz aperitivo/degustazione  
5 Stück Verkostung/Dessert Set  
Set 5 pcs dégustation/dessert  
Juego de degustación/postre 5 pz  
.....  
art. dim. cm. ml.  
41205-01 35x10 4x43



**AR**

**5 pcs tasting/dessert set**  
Set 5 pz aperitivo/degustazione  
5 Stück Verkostung/Dessert Set  
Set 5 pcs dégustation/dessert  
Juego de degustación/postre 5 pz  
.....  
art. dim. cm. ml.  
41205-02 35x10 4x110



**W**

**5 pcs tasting/dessert set**  
Set 5 pz aperitivo/degustazione  
5 Stück Verkostung/Dessert Set  
Set 5 pcs dégustation/dessert  
Juego de degustación/postre 5 pz  
.....  
art. dim. cm. ml.  
41205-03 49x9,7x1,8 4x176



**W**

**4 pcs tasting/dessert set**  
Set 4 pz aperitivo/degustazione  
4 Stück Verkostung/Dessert Set  
Set 4 pcs dégustation/dessert  
Juego de degustación/postre 4 pz  
.....  
art. dim. cm. ml.  
41205-04 35x11x1,8 3x147



**W**

**4 pcs tasting/dessert set**  
Set 4 pz aperitivo/degustazione  
4 Stück Verkostung/Dessert Set  
Set 4 pcs dégustation/dessert  
Juego de degustación/postre 4 pz  
.....  
art. dim. cm. ml.  
41205-05 45x11x1,8 3x147



**W**

**5 pcs tasting/dessert set**  
Set 5 pz aperitivo/degustazione  
5 Stück Verkostung/Dessert Set  
Set 5 pcs dégustation/dessert  
Juego de degustación/postre 5 pz  
.....  
art. dim. cm. ml.  
41205-06 45x9x1,8



**W**

**4 pcs tasting/dessert set**  
Set 4 pz aperitivo/degustazione  
4 Stück Verkostung/Dessert Set  
Set 4 pcs dégustation/dessert  
Juego de degustación/postre 4 pz  
.....  
art. dim. cm.  
41205-10 35x11x2



**NEW**

**W**

**7 pcs tasting/dessert set**  
Set 7 pz aperitivo/degustazione  
7 Stück Verkostung/Dessert Set  
Set 7 pcs dégustation/dessert  
Juego de degustación/postre 7 pz  
.....  
art. dim. cm.  
41206-04 38x12x1



TRAYS  
VASSOI PLANK



In reinforced polyester, suitable for food contact, dishwasher safe. Natural rough finish and elegant at the same time. They can be used as showplate and as presentation tray as well. Available in 3 colors. Non-slip foot available on request item 41323-AA.

Plance in poliestere rinforzato, idoneo al contatto alimentare, lavabile in lavastoviglie. Finitura ruvida naturale ed elegante al tempo stesso. Possono essere utilizzate come piatto presentazione e come vassoi espositivi. Disponibili in 3 colorazioni. Piedini antiscivolo in opzione art. 41323-AA.



**Tray, rectangular**  
Plancia rettangolare  
Platte, rechteckig  
Plateau rectangulaire  
Placa rectangular

| art.     | dim. cm.  | col. |
|----------|-----------|------|
| 41323-11 | 30x20x0,5 | ●    |
| 41323-12 | 40x20x0,5 | ●    |
| 41323-13 | 40x30x0,5 | ●    |
| 41323-14 | 60x40x0,5 | ●    |



**Tray, rectangular**  
Plancia rettangolare  
Platte, rechteckig  
Plateau rectangulaire  
Placa rectangular

| art.     | dim. cm.  | col. |
|----------|-----------|------|
| 41323-21 | 30x20x0,5 | ●    |
| 41323-22 | 40x20x0,5 | ●    |
| 41323-23 | 40x30x0,5 | ●    |
| 41323-24 | 60x40x0,5 | ●    |



**Tray, rectangular**  
Plancia rettangolare  
Platte, rechteckig  
Plateau rectangulaire  
Placa rectangular

| art.     | dim. cm.  | col. |
|----------|-----------|------|
| 41323-01 | 30x20x0,5 | ●    |
| 41323-02 | 40x20x0,5 | ●    |
| 41323-03 | 40x30x0,5 | ●    |
| 41323-04 | 60x40x0,5 | ●    |



**Tray, round**  
Plancia rotonda  
Platte, rund  
Plateau ronde  
Placa redonda

| art.     | Ø cm. | h. cm. | col. |
|----------|-------|--------|------|
| 41323-16 | 30    | 0,5    | ●    |
| 41323-17 | 38    | 0,5    | ●    |
| 41323-18 | 40    | 0,5    | ●    |



**Tray, round**  
Plancia rotonda  
Platte, rund  
Plateau ronde  
Placa redonda

| art.     | Ø cm. | h. cm. | col. |
|----------|-------|--------|------|
| 41323-26 | 30    | 0,5    | ●    |
| 41323-27 | 38    | 0,5    | ●    |
| 41323-28 | 40    | 0,5    | ●    |



**Tray, round**  
Plancia rotonda  
Platte, rund  
Plateau ronde  
Placa redonda

| art.     | Ø cm. | h. cm. | col. |
|----------|-------|--------|------|
| 41323-06 | 30    | 0,5    | ●    |
| 41323-07 | 38    | 0,5    | ●    |
| 41323-08 | 40    | 0,5    | ●    |





HDPE



**Tray support**

Supporto per vassoio  
Tablett Unterstützung  
Support pour plateaux  
Soporte para bandejas

art. dim. cm. U. Pack  
41323-99 5x5x6 24



**TRAYS WOOD EFFECT  
VASSOI EFFETTO LEGNO**



GN

**Rectangular platter**

Vassoio rettangolare  
Tablett, Rechteckig  
Plateau rectangulaire  
Bandeja rectangular

art. dim. cm.  
44473-31 53x32,5x0,8  
44473-32 32,5x26,5x0,8  
44473-34 26x16x0,8  
44473-33 32,5x17,5x0,8



**Round platter**

Vassoio rotondo  
Tablett, Rund  
Plateau rond  
Bandeja redonda

art. Ø cm. h. cm.  
44473-02 33 0,8  
44473-03 43 0,8



**Round platter with handle**

Vassoio rotondo con manico  
Tablett, Rund mit Griff  
Plateau rond avec manche  
Bandeja redonda con mango

art. Ø cm. h. cm.  
44473-05 38 1,5



**Rectangular platter with handle**  
 Vassoio rettangolare con manico  
 Tablett Rechteckig mit Griff  
 Plateau rectangulaire avec manche  
 Bandeja rectangular con mango

art. dim. cm.  
 44473-07 53x20x1,5



**Rectangular platter with handle**  
 Vassoio rettangolare con manico  
 Tablett Rechteckig mit Griff  
 Plateau rectangulaire avec manche  
 Bandeja rectangular con mango

art. dim. cm.  
 44473-08 61x20x1,5



**Tray, rectangular**  
 Plancia rettangolare  
 Platte, rechteckig  
 Plateau rectangulaire  
 Placa rectangular

art. dim. cm.  
 44471-11 53x32,5x1,5  
 44471-12 32,5x26,5x1,5  
 44471-13 32,5x17,6x1,5  
 44471-14 26,5x16,2x1,5  
 44471-24 53x16,2x1,5

**WOODEN SERVING BOARDS**  
 TAGLIERI IN LEGNO



Each piece is carefully handcrafted therefore size, shape and finish may vary from piece to piece. Wash by hand with warm soapy water, do not to soak.

Ogni pezzo è realizzato a mano quindi dimensioni, forma e finitura variano da pezzo a pezzo. Lavare a mano con acqua tiepida e sapone. Non mettere in ammollo.



**Serving board**  
 Tagliere  
 Servier-Brett  
 Planche de service  
 Tabla

art. dim. cm.  
 41327-01 45,5x20

Acacia wood. – Acacia.



**Bowl**  
 Ciotola  
 Schüssel  
 Bol  
 Bol

art. Ø cm.  
 41327-02 25,5

Acacia wood. – Acacia.



**Serving board**  
 Tagliere  
 Servier-Brett  
 Planche de service  
 Tabla

art. Ø cm.  
 41327-03 20,0  
 41327-04 25,5  
 41327-05 30,5

Acacia wood. – Acacia.



**NEW**  
**W**

**Serving board**  
Tagliere  
Servier-Brett  
Planche de service  
Tabla

| art.     | Ø cm. |
|----------|-------|
| 41327-06 | 19,5  |
| 41327-07 | 24,0  |
| 41327-08 | 29,5  |

**Acacia wood. – Acacia.**



**NEW**  
**W**

**Serving board**  
Tagliere  
Servier-Brett  
Planche de service  
Tabla

| art.     | Ø cm. |
|----------|-------|
| 41327-09 | 24    |
| 41327-10 | 30    |

**Acacia wood. – Acacia.**



**W**

**Serving board**  
Tagliere  
Servier-Brett  
Planche de service  
Tabla

| art.     | dim. cm.  |
|----------|-----------|
| 41320-25 | 25x17x1,5 |
| 41320-30 | 30x20,5x2 |
| 41320-35 | 35x24x2   |

**Olive wood. – Ulivo.**



**W**

**Serving board**  
Tagliere  
Servier-Brett  
Planche de service  
Tabla

| art.     | dim. cm.  | l.    |
|----------|-----------|-------|
| 41321-40 | 40x15x1,5 | 40+11 |
| 41321-44 | 44x20x2   | 44+12 |

**Olive wood. – Ulivo.**



**W**

**Serving board**  
Tagliere  
Servier-Brett  
Planche de service  
Tabla

| art.     | dim. cm.    | l.   |
|----------|-------------|------|
| 41322-19 | 19x12,2x1,5 | 19+6 |
| 41322-25 | 25x16x1,5   | 25+8 |
| 41322-31 | 31x20x1,5   | 31+9 |

**Olive wood. – Ulivo.**



**W**

**Serving board**  
Tagliere  
Servier-Brett  
Planche de service  
Tabla

| art.     | dim. cm. |
|----------|----------|
| 41325-20 | 20x12x3  |

**Birch wood. – Betulla.**



**W**

**Serving board**  
Tagliere  
Servier-Brett  
Planche de service  
Tabla

| art.     | dim. cm. |
|----------|----------|
| 41325-30 | 30x20x3  |

**Birch wood. – Betulla.**



**W**

**Serving board**  
Tagliere  
Servier-Brett  
Planche de service  
Tabla

| art.     | dim. cm. |
|----------|----------|
| 41325-40 | 40x15x3  |

**Birch wood. – Betulla.**



**NEW**  
**W**  
**AR**

**Serving board set 4 pieces**  
Tagliere set 4 pezzi  
Servier-Brett, 4-tlg  
Planche de service, set 4 pièces  
Tabla juego 4 piezas

| art.     | dim. cm.  |
|----------|-----------|
| 41206-01 | 35x23x1,5 |

**Pine wood. – Pino.**



**NEW**  
**W**  
**AR**

**Serving board set 3 pieces**  
Tagliere set 3 pezzi  
Servier-Brett, 3-tlg  
Planche de service, set 3 pièces  
Tabla juego 3 piezas

| art.     | dim. cm.  |
|----------|-----------|
| 41206-02 | 37x17x1,8 |

**Pine wood. – Pino.**



**NEW**  
**W**

**Coffee set 4 pieces**  
Servizio caffè 4 pezzi  
Kaffeaset 4 Stk  
Service à café 4 pièces  
Servicio de café 4 piezas

| art.     | dim. cm.    |
|----------|-------------|
| 41206-03 | 25x18,7x2,5 |

**Acacia wood. – Acacia.**



AR  
W

**Serving board**  
Tagliere  
Servier-Brett  
Planche de service  
Tabla

art. dim. cm.  
41326-30 30,5x13x1,5

Acacia wood. – Acacia.



AR  
W

**Serving board**  
Tagliere  
Servier-Brett  
Planche de service  
Tabla

art. dim. cm.  
41326-36 36,5x15x1,5

Acacia wood. – Acacia.



AR  
W

**Serving board**  
Tagliere  
Servier-Brett  
Planche de service  
Tabla

art. dim. cm.  
41326-42 42x18x1,5

Acacia wood. – Acacia.



NEW  
W  
AR

**2-Tier serving stand**  
Alzata 2 piani  
2-stufiger Servierstand  
Support 2 niveaux  
Soporte 2 pisos

art. dim. cm.  
41207-02 25x4,5x34,5

Beech. Slate cm. 31x13 - 41x18. – Faggio. Ardesia cm. 31x13 - 41x18.



NEW  
W  
AR

**3-Tier serving stand**  
Alzata 3 piani  
3-stufiger Servierstand  
Support 3 niveaux  
Soporte 3 pisos

art. dim. cm.  
25x4,5x54

Beech. Slate cm. 21x8 - 31x13 - 41x18. – Faggio. Ardesia cm. 21x831x13 - 41x18.



W

**Service dish with porcelain surface**  
Tagliere legno con superficie porcellanata  
Servierplatte mit Porzellan-Oberfläche  
Plat à servir avec surface en porcelaine  
Tabla con superficie porcelana

art. dim. cm. Por.  
44249S30 20x30x2,5 1-2  
44249S35 25x35x2,5 1-2



W

**Service dish with porcelain surface**  
Tagliere legno con superficie porcellanata  
Servierplatte mit Porzellan-Oberfläche  
Plat à servir avec surface en porcelaine  
Tabla con superficie porcelana

art. Ø cm. Por.  
44250S30 30 1-2  
44250S35 35 1-2



W

**Platter with porcelain surface**  
Tagliere con superficie porcellanata  
Platte mit Porzellan-Oberfläche  
Plat à servir avec surface en porcelaine  
Tabla con superficie porcelana

art. dim. cm. Por.  
44248S60 60x15x2,5 4



W

**Platter with porcelain surface**  
Tagliere con superficie porcellanata  
Platte mit Porzellan-Oberfläche  
Plat à servir avec surface en porcelaine  
Tabla con superficie porcelana

art. Ø cm. h. cm. Por.  
44254-30 31 2,5 1

Iroko wood. – Iroko



W

**Wooden service platter**  
Tagliere legno  
Holzbrett  
Planche à Servir en bois  
Tabla madera

art. Por.  
44258-60 4-6

Iroko wood. – Iroko



W

**Wooden service platter**

Tagliere legno  
Holzbrett  
Planche à Servir en bois  
Tabla madera

| art.     | Ø cm. | h. cm. | Por. |
|----------|-------|--------|------|
| 44259-29 | 29    | 2,5    | 1-2  |

**Iroko wood.** – Iroko



W

**Wooden service platter**

Tagliere legno  
Holzbrett  
Planche à Servir en bois  
Tabla madera

| art.     | dim. cm.  | Por. |
|----------|-----------|------|
| 44264-35 | 25x35x1,8 | 1-2  |

**Iroko wood.** – Iroko



W

**Wooden service platter**

Tagliere legno  
Holzbrett  
Planche à Servir en bois  
Tabla madera

| art.     | dim. cm.  | Por. |
|----------|-----------|------|
| 44265-35 | 25x35x1,8 | 1-2  |

**Iroko wood.** – Iroko



W

**Wooden service platter**

Tagliere legno  
Holzbrett  
Planche à Servir en bois  
Tabla madera

| art.     | dim. cm.  | Por. |
|----------|-----------|------|
| 44260-30 | 30x43x1,8 | 1-2  |
| 44260-34 | 34x47x1,8 | 2    |

**Iroko wood.** – Iroko



W

**Wooden service platter**

Tagliere legno  
Holzbrett  
Planche à Servir en bois  
Tabla madera

| art.     | dim. cm.  | Por. |
|----------|-----------|------|
| 44261-46 | 34x46x2,5 | 2    |

**Iroko wood.** – Iroko



W

**Wooden service platter**

Tagliere legno  
Holzbrett  
Planche à Servir en bois  
Tabla madera

| art.     | dim. cm.  | Por. |
|----------|-----------|------|
| 44262-42 | 26x42x2,5 | 1-2  |

**Iroko wood.** – Iroko



W

**Wooden service platter**

Tagliere legno  
Holzbrett  
Planche à Servir en bois  
Tabla madera

| art.     | dim. cm.  | Por. |
|----------|-----------|------|
| 44263-36 | 14x36x3,5 | 1-2  |

**Iroko wood.** – Iroko



W

**Single source pot wooden platter**

Porta coppetta singolo  
Schale-Träger einzel  
Support à bol simple  
Soporte copa individual

| art.     | Ø cm. | dim. cm. |
|----------|-------|----------|
| 44256-01 | 5,5   | 8x11x1,8 |

**Beechwood. WITHOUT cup. See pages 343, 395, 396.** – Faggio. SENZA ciotolina. Vedi pagg. 343, 395, 396.



W

**Twice source pot wooden platter**

Porta coppette doppio  
Schale-Träger doppel  
Support à bol double  
Soporte copa doble

| art.     | Ø cm. | dim. cm. |
|----------|-------|----------|
| 44256-02 | 5,5   | 8x20x1,8 |

**Beechwood. WITHOUT cups. See pages 343, 395, 396.** – Faggio. SENZA ciotoline. Vedi pagg. 343, 395, 396.



W

**Triple source pot wooden platter**

Porta coppette triplo  
Schale-Träger dreifach  
Support à bol triple  
Soporte copa triple

| art.     | Ø cm. | dim. cm. |
|----------|-------|----------|
| 44256-03 | 5,5   | 8x28x1,8 |

**Beechwood. WITHOUT cups. See pages 343, 395, 396.** – Faggio. SENZA ciotoline. Vedi pagg. 343, 395, 396.



W

**Quartet source pot wooden platter**

Porta coppette quadruplo  
Schale-Träger vierfach  
Support à bol quadruple  
Soporte copa cuatro veces

| art.     | Ø cm. | dim. cm. |
|----------|-------|----------|
| 44256-04 | 5,5   | 8x36x1,8 |

**Beechwood. WITHOUT cups. See pages 343, 395, 396.** – Faggio. SENZA ciotoline. Vedi pagg. 343, 395, 396.

NATURAL ELEGANT



A valid alternative to glass. Elegant and unbreakable ideal for HORECA pastry and ice cream sector. Made with high quality material that confers beside resistance also glossiness and perfect transparency. Bisphenol free. Thermal tolerance -18°C +70°C. 100% recyclable material. Dishwasher safe: up to 50 washes. Made in Italy.

La valida alternativa al vetro. Eleganti ed infrangibili ideali per il settore HORECA della pasticceria e gelateria. Realizzati con materiale di alta qualità che gli conferisce oltre alla resistenza anche lucidità e trasparenza. Privi di Bisfenolo. Tolleranza termica -18°C +70°C. Materiale riciclabile al 100%. Lavabili in lavastoviglie: fino a 50 lavaggi. Prodotti made in Italy.



**NEW**  
**PS**

**Tasting glass**

Bicchierino degustazione  
Verkostung Glas  
Verrine dégustation  
Vaso degustación

| art.     | dim. cm. | h. cm. | ml. |
|----------|----------|--------|-----|
| 48368-05 | 6,4x4,6  | 5,3    | 50  |
| 48368-12 | 8,5x6    | 7,0    | 120 |
| 48368-20 | 10x7     | 8,2    | 200 |

**Set 100 pcs. – Conf. 100 pz.**



**NEW**  
**PS**

**Tasting dish**

Piattino degustazione  
Verkostung Teller  
Assiette dégustation  
Platillo degustación

| art.     | Ø cm. |
|----------|-------|
| 48372-08 | 8     |

**Set 100 pcs. – Conf. 100 pz.**



**PS**

**Tasting glass**

Bicchierino degustazione  
Verkostung Glas  
Verrine dégustation  
Vaso degustación

| art.     | Ø cm. | h. cm. | ml. |
|----------|-------|--------|-----|
| 48353-01 | 8,5   | 6,5    | 120 |

**Set 100 pcs. – Conf. 100 pz.**



**NEW**  
**PS**

**Tasting glass**

Bicchierino degustazione  
Verkostung Glas  
Verrine dégustation  
Vaso degustación

| art.     | dim. cm. | h. cm. | ml. |
|----------|----------|--------|-----|
| 48369-08 | 6,3x6,9  | 5,7    | 85  |
| 48369-14 | 7,3x8,1  | 6,7    | 140 |
| 48369-20 | 9x8,3    | 7,4    | 200 |

**Set 100 pcs. – Conf. 100 pz.**





PS

**Tasting glass**

Bicchierino degustazione  
Verkostung Glas  
Verrine dégustation  
Vaso degustación

| art.     | Ø cm. | h. cm. | ml. |
|----------|-------|--------|-----|
| 48354-01 | 4     | 8,5    | 70  |

**Set 100 pcs. – Conf. 100 pz.**



PS

**Tasting bowl**

Piattino degustazione  
Verkostung Teller  
Assiette dégustation  
Platillo degustación

| art.     | Ø cm. | ml. |
|----------|-------|-----|
| 48359-01 | 6,5   | 15  |

**Set 100 pcs. – Conf. 100 pz.**



PS

**Tasting bowl**

Ciotolina degustazione  
Verkostung Schale  
Bol dégustation  
Bol degustación

| art.     | Ø cm. | ml. |
|----------|-------|-----|
| 48357-01 | 7,5   | 50  |

**Set 100 pcs. – Conf. 100 pz.**



PS

**Tasting dish**

Piattino degustazione  
Verkostung Teller  
Assiette dégustation  
Platillo degustación

| art.     | Ø cm. | h. cm. | ml. |
|----------|-------|--------|-----|
| 48355-01 | 9     | 1,5    | 20  |

**Set 100 pcs. – Conf. 100 pz.**



PS

**Tasting bowl**

Ciotolina degustazione  
Verkostung Schale  
Bol dégustation  
Bol degustación

| art.     | Ø cm. | ml. |
|----------|-------|-----|
| 48356-01 | 8,5   | 30  |

**Set 100 pcs. – Conf. 100 pz.**



PS



**Tasting bowl**

Ciotolina degustazione  
Verkostung Schale  
Bol dégustation  
Bol degustación

| art.     | dim. cm. | ml. |
|----------|----------|-----|
| 48358-01 | 10,5x5x3 | 11  |

**Set 100 pcs. – Conf. 100 pz.**





FINGERFOOD



**Oval tweested dish**  
Ovalina goccia

art. dim. cm.  
41200-01 9x5x3



**Eye dish**  
Ovalina occhio

art. dim. cm.  
41200-02 8,1x5,6x3



**Egg dish**  
Tegamino 2/m

art. dim. cm.  
41200-03 8,5x6,8x2



**Oval dish**  
Ovalina

art. dim. cm.  
41200-04 10x5,5x2,7



**Soya sauce dish**  
Rettangolare

art. dim. cm.  
41200-05 8x5,5x1,8



**Square dish**  
Piatino quadro

art. dim. cm.  
41200-06 8x8x2,4



**Oriental square dish**  
Quadrato orientale

art. dim. cm.  
41200-07 7,5x7,5x3



**Dye dish**  
Cubo

art. dim. cm.  
41200-08 5,2x5,2x4



**Chao dish**  
Quadrato punte

art. dim. cm.  
41200-09 8x8x5



**Tear dish**  
Foglia

art. dim. cm.  
41200-10 8x7x3,4



**Nem dish**  
Tronchetto

art. dim. cm.  
41200-11 5,5x4,5x6,5



**Rectangular w/lid**  
Rettangolare c/cop

art. dim. cm.  
41200-13 10x5,5x4,5



**Square pan with lid**  
Quadra c/cop

art. dim. cm.  
41200-14 9x3,6x4,5



**Oval pan with lid**  
Ovale c/cop

art. dim. cm.  
41200-15 10,5x7x4,5



**Rectangular pan**  
Casseruola rett.

art. dim. cm.  
41200-16 10x5,5x4,5



**Square pan**  
Casseruola quadra

art. dim. cm.  
41200-17 9x3,6x4,5





**Oval pan**  
Casseruola ovale

art. dim. cm.  
41200-18 10,5x7x4,5



**Footed square dish**  
Quadrato

art. dim. cm.  
41200-32 10x10x1,2



**Fish dish**  
Piattino pesce

art. dim. cm.  
41200-33 10,5x5x1,6



**Small pan**  
Tegamino

art. dim. cm.  
41200-34 9,7x6x2,6



**Mini pasta bowl**  
Mini ciotola pasta

art. dim. cm.  
41200-36 10x2,5x1,6



**Square dish**  
Coppetta quadra

art. dim. cm.  
41200-40 7x7x3,5



**Round bowl**  
Bolo tondo

art. Ø cm. h. cm.  
41200-41 7 4,5



**Small pot**  
Mini pentola

art. dim. cm.  
41200-49 5x5x5



**Small bucket**  
Secchiello

art. dim. cm.  
41200-50 6x6x4,5



**Colander**  
Colapasta

art. dim. cm.  
41200-51 7x7x4,5



**Fruit case**  
Cassetta frutta

art. dim. cm.  
41200-52 8x5,5x2,3



**Tin with lid**  
Scatoletta c/cop

art. dim. cm.  
41200-53 13,5x5,5x5



**Tin with lid**  
Scatoletta c/cop

art. Ø cm. h. cm.  
41200-54 13,5 4



**French fries bowl**  
Vaschetta patatine

art. dim. cm.  
41200-58 13x10x4



**Rectangular w/handles**  
 Rettangolare c/m

art. dim. cm.  
41200-59 14x10x3,5



**Rectangular lid**  
Coperchio rett.

art. dim. cm.  
41200-60 14x10



**Oval w/handles**  
Ovale c/m

art. dim. cm.  
41200-61 14x9,5x3,5



**Oval lid**  
Coperchio ovale

art. dim. cm.  
41200-62 14x9,5



**Round w/handles**  
Tonda c/m

art. Ø cm. h. cm.  
41200-63 13 5,5



**Round lid**  
Coperchio tondo

art. Ø cm.  
41200-64 13



**Ramequin**  
Ramequin

art. Ø cm. h. cm.  
41200-46 10 5,0  
41200-47 9 5,0  
41200-48 8 4,5



**Vintage tray**  
Vassoietto vintage

art. dim. cm.  
41200-55 15x10x1,7



**Vintage tray**  
Vassoietto vintage

art. dim. cm.  
41200-56 22,3x14x2



**Vintage tray**  
Vassoietto vintage

art. dim. cm.  
41200-57 29,5x20,5x2

# TABLE TOP TAVOLA

SERVING ITEMS  
COMPLEMENTI



TABLE MATS & RUNNERS



Material: 50% polyester - 50% Polyvinyl chloride

Materiale: 50% Poliestere - 50% Cloruro di polivinile



**Table mat - Light melange**  
Tovaglietta - Melange chiaro

| art.     | dim. cm. | pcs/pz |
|----------|----------|--------|
| 42950-01 | 42x33    | 6      |



**Table mat - Brown**  
Tovaglietta - Marrone

| art.     | dim. cm. | pcs/pz |
|----------|----------|--------|
| 42950-04 | 42x33    | 6      |



**Table mat - Crispy**  
Tovaglietta - Croccante

| art.     | dim. cm. | pcs/pz |
|----------|----------|--------|
| 42950-07 | 42x33    | 6      |

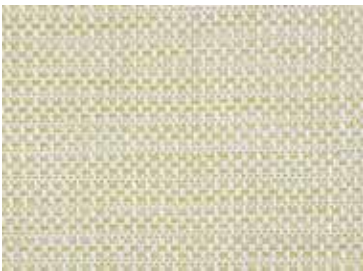

**Table mat - Sandy**  
Tovaglietta - Beige

| art.     | dim. cm. | pcs/pz |
|----------|----------|--------|
| 42950-02 | 42x33    | 6      |



**Table mat - Beige-Grey**  
Tovaglietta - Beige-Grigio

| art.     | dim. cm. | pcs/pz |
|----------|----------|--------|
| 42950-05 | 42x33    | 6      |



**Table mat - Coral**  
Tovaglietta - Corallo

| art.     | dim. cm. | pcs/pz |
|----------|----------|--------|
| 42950-08 | 42x33    | 6      |



**Table mat - Black**  
Tovaglietta - Nero

| art.     | dim. cm. | pcs/pz |
|----------|----------|--------|
| 42950-03 | 42x33    | 6      |



**Table mat - Grey**  
Tovaglietta - Grigio

| art.     | dim. cm. | pcs/pz |
|----------|----------|--------|
| 42950-06 | 42x33    | 6      |



**Table mat - White pin-striped**  
Tovaglietta - Gessato bianco

| art.     | dim. cm. | pcs/pz |
|----------|----------|--------|
| 42950-09 | 42x33    | 6      |

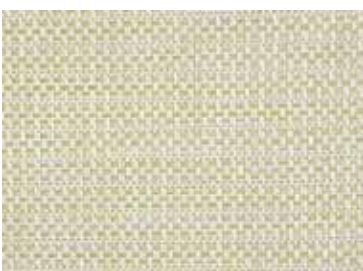

**RUNNER - Sandy**  
Beige

| art.     | dim. cm. |
|----------|----------|
| 42950-92 | 42x180   |

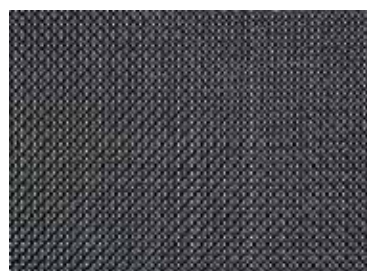

**RUNNER - Black**  
Nero

| art.     | dim. cm. |
|----------|----------|
| 42950-93 | 42x180   |



**RUNNER - Brown**  
Marrone

| art.     | dim. cm. |
|----------|----------|
| 42950-94 | 42x180   |



NATURAL SLATE  
ARDESIA NATURALE



Excellent coldness retention, food safe. The edges of the trays are broken to show the typical structure of the natural material. With anti-slip feet. No dishwasher proof. Material thickness: 4-7 mm.

Eccellente immagazzinamento del freddo, idonei al contatto alimentare. Gli angoli dei piani sono spezzati per evidenziare la tipica struttura del materiale. Con piedini antiscivolo. Non idonei al lavaggio in lavastoviglie. Spessore: 4-7 mm.



**Tray**  
Vassoio  
Platte  
Plateau  
Placa

| art.     | dim. cm. |
|----------|----------|
| 41585-37 | 20x10    |



**Tray**  
Plancia  
Platte  
Plateau  
Placa

| art.     | GN  | dim. cm.  |
|----------|-----|-----------|
| 41585-11 | 1/1 | 53x32,2   |
| 41585-12 | 1/2 | 32,5x26,5 |
| 41585-13 | 1/3 | 32,5x17,5 |
| 41585-24 | 1/4 | 26,5x16,5 |
| 41585-23 | 2/4 | 53x16,2   |



**Square tray**  
Plancia quadra  
Platte, viereckig  
Plateau carré  
Placa cuadrada

| art.     | dim. cm. |
|----------|----------|
| 41585-25 | 25x25    |
| 41585-30 | 30x30    |



**Rectangulat tray**

Plancia rettangolare  
Platte, rechteckig  
Plateau rectangulaire  
Placa rectangular

| art.     | dim. cm. |
|----------|----------|
| 41585-45 | 45x30    |



**Round tray**

Plancia tonda  
Platte, rund  
Plaque ronde  
Placa redonda

| art.     | Ø cm. |
|----------|-------|
| 41586-22 | 22    |
| 41586-28 | 28    |
| 41586-33 | 33    |
| 41586-38 | 38    |



**Square tray, 4 pcs set**

Plancia quadra, set 4 pz  
Platte, viereckig, Satz 4 Stk  
Plateau carré, set 4 pcs  
Placa cuadrada, juego 4 pz

| art.     | dim. cm. |
|----------|----------|
| 41585-10 | 10x10    |



**Tray with holes**

Vassoio con fori  
Platte mit Absätze  
Plat avec trous  
Placa con agujeros

| art.     | Ø cm. | dim. cm. |
|----------|-------|----------|
| 41585-01 | 6     | 25x12    |



**Tray with holes**

Vassoio con fori  
Platte mit Absätze  
Plat avec trous  
Placa con agujeros

| art.     | Ø cm. | dim. cm. |
|----------|-------|----------|
| 41585-02 | 6     | 15x8     |



**Tray with holes**

Vassoio con fori  
Platte mit Absätze  
Plat avec trous  
Placa con agujeros

| art.     | Ø cm. | dim. cm. |
|----------|-------|----------|
| 41585-03 | 6     | 28x10    |



**Tray with dome**

Piatto con campana  
Platte mit Glashaube  
Plat avec cloche  
Bandeja y campana de cristal

| art.     | Ø cm. | h. cm. |
|----------|-------|--------|
| 41585-00 | 10,5  | 8      |



**2 tier tray**

Alzata 2 piani  
2-stufige Etagère  
Présentoir 2 niveaux  
Bandeja dos niveles

| art.     | Ø cm. | h. cm. |
|----------|-------|--------|
| 41587-25 | 20-25 | 24     |



**Revolving platter**

Supporto girevole  
Servierplatt, drehbar  
Présentoir tournant  
Soporte rotatorio

| art.     | Ø cm. | h. cm. |
|----------|-------|--------|
| 41587-32 | 32    | 2,5    |



**Tray**

Plancia  
Platte  
Plateau  
Placa

| art.     | dim. cm.  | fits/per |
|----------|-----------|----------|
| 41585-51 | 24x15     | 44842-30 |
| 41585-52 | 47x10     | 44843-24 |
| 41585-53 | 26,5x20,5 | 44843-12 |
| 41585-54 | 32x12     | 44842-35 |

41585-52 + 44843-24



41585-53 + 44843-12



41585-51 + 44842-30



41585-54 + 44842-35



**BLACK & BROWN - FEELS LIKE CLAY**  
NERO & MARRONE - SENSAZIONE D'ARGILLA



**Black with brown edges. - Nero con bordi marrone.**

An imitation of clay, with a brown border. The surface is inside and outside fine-matt. Feels like real clay. - Una perfetta imitazione di argilla, con bordo marrone. Superficie interna ed esterna finemente opaca e con effetto argilla al tatto.



**Bowl**  
Ciotola  
Schüssel  
Bol

| art.     | dim. cm.    | lt. |
|----------|-------------|-----|
| 44480-00 | 25,5x14x5,5 | 0,4 |
| 44480-01 | 36x19x8     | 0,9 |



**Tray**  
Vassoio  
Tablett  
Plateau  
Bandeja

| art.     | dim. cm.    |
|----------|-------------|
| 44480-03 | 14,5x14,5x2 |



**Tray**  
Vassoio  
Tablett  
Plateau  
Bandeja

| art.     | dim. cm.  |
|----------|-----------|
| 44480-04 | 22,5x15x3 |
| 44480-05 | 27,5x11x2 |



**Tray**  
Vassoio  
Tablett  
Plateau  
Bandeja

| art.     | dim. cm.    |
|----------|-------------|
| 44480-06 | 26,5x16,5x4 |



**Bowl**  
Ciotola  
Schüssel  
Bol

| art.     | Ø cm. | h. cm. | lt.  |
|----------|-------|--------|------|
| 44480-07 | 8,5   | 2,5    | 0,05 |



**Bowl**  
Ciotola  
Schüssel  
Bol

| art.     | Ø cm. | h. cm. | lt.  |
|----------|-------|--------|------|
| 44480-08 | 11,5  | 3      | 0,04 |



**Bowl**  
Ciotola  
Schüssel  
Bol

| art.     | Ø cm. | h. cm. | lt. |
|----------|-------|--------|-----|
| 44480-09 | 11    | 5,5    | 0,2 |



**Bowl**  
Ciotola  
Schüssel  
Bol

| art.     | Ø cm. | h. cm. | lt. |
|----------|-------|--------|-----|
| 44480-10 | 14    | 6,0    | 0,3 |
| 44480-11 | 19    | 8,0    | 0,8 |
| 44480-12 | 21    | 8,5    | 1,0 |
| 44480-13 | 24    | 9,5    | 1,4 |



**Bowl**  
Ciotola  
Schüssel  
Bol

| art.     | dim. cm.      | lt. |
|----------|---------------|-----|
| 44480-14 | 23,5x23,5x6,5 | 0,7 |





**Bowl**  
Ciotola  
Schüssel  
Bol  
Bol

| art.     | Ø cm. | h. cm. | lt.  |
|----------|-------|--------|------|
| 44480-15 | 11    | 3,5    | 0,13 |
| 44480-16 | 14    | 4,0    | 0,20 |
| 44480-20 | 30,5  | 8,5    | 2,00 |



**Tray**  
Vassoio  
Tablett  
Plateau  
Bandeja

| art.     | dim. cm.   |
|----------|------------|
| 44480-17 | 19,5x9,5x2 |
| 44480-18 | 39x16x3    |



**Tray**  
Vassoio  
Tablett  
Plateau  
Bandeja

| art.     | dim. cm.      |
|----------|---------------|
| 44480-19 | 32,5x23,5x4,5 |



**Soup plate**  
Piatto fondo  
Teller tief  
Assiette creuse  
Plato hondo

| art.     | Ø cm. | h. cm. | lt. | col. |
|----------|-------|--------|-----|------|
| 44478-20 | 20,5  | 3      | 0,5 | ●    |



**Soup plate**  
Piatto fondo  
Teller tief  
Assiette creuse  
Plato hondo

| art.     | Ø cm. | h. cm. | lt. | col. |
|----------|-------|--------|-----|------|
| 44478-21 | 20,5  | 3      | 0,5 | ●    |



**Flat plate**  
Piatto piano  
Teller flach  
Assiette plate  
Plato llano

| art.     | dim. cm.  | col. |
|----------|-----------|------|
| 44478-22 | 14x13x2,5 | ●    |



**Flat plate**  
Piatto piano  
Teller flach  
Assiette plate  
Plato llano

| art.     | dim. cm.  | col. |
|----------|-----------|------|
| 44478-23 | 14x13x2,5 | ●    |



**Bowl**  
Ciotola  
Schüssel  
Bol  
Bol

| art.     | Ø cm. | h. cm. | lt.  | col. |
|----------|-------|--------|------|------|
| 44478-24 | 12,5  | 6      | 0,37 | ●    |
| 44478-26 | 16    | 7      | 0,70 | ●    |



**Bowl**  
Ciotola  
Schüssel  
Bol  
Bol

| art.     | Ø cm. | h. cm. | lt.  | col. |
|----------|-------|--------|------|------|
| 44478-25 | 12,5  | 6      | 0,37 | ●    |
| 44478-27 | 16    | 7      | 0,70 | ●    |



**Bowl**  
Ciotola  
Schüssel  
Bol  
Bol

| art.     | Ø cm. | h. cm. | lt. | col. |
|----------|-------|--------|-----|------|
| 44478-28 | 16,5  | 4      | 0,5 | ●    |



**Bowl**  
Ciotola  
Schüssel  
Bol  
Bol

| art.     | Ø cm. | h. cm. | lt. | col. |
|----------|-------|--------|-----|------|
| 44478-29 | 16,5  | 4      | 0,5 | ●    |



**Bowl**  
Ciotola  
Schüssel  
Bol  
Bol

| art.     | Ø cm. | h. cm. | lt.  | col. |
|----------|-------|--------|------|------|
| 44478-30 | 21    | 8      | 1,45 | ●    |



**Bowl**  
Ciotola  
Schüssel  
Bol  
Bol

| art.     | Ø cm. | h. cm. | lt.  | col. |
|----------|-------|--------|------|------|
| 44478-31 | 21    | 8      | 1,45 | ●    |



**Bowl**  
Ciotola  
Schüssel  
Bol  
Bol

| art.     | dim. cm.    | lt.  | col. |
|----------|-------------|------|------|
| 44478-32 | 30,5x10x7,5 | 0,17 | ●    |
| 44478-34 | 42x14x9,5   | 0,65 | ●    |



**Bowl**  
Ciotola  
Schüssel  
Bol  
Bol

| art.     | dim. cm.    | lt.  | col. |
|----------|-------------|------|------|
| 44478-33 | 30,5x10x7,5 | 0,17 | ●    |
| 44478-35 | 42x14x9,5   | 0,65 | ●    |

GLASS JARS  
VASETTI WECK



Perfect for the sterilization and pasteurization of any product, fruit, vegetables, but also meat, fish, foie gras or delicatessen products. They are suitable for serving jams and sauces: they also look beautiful on the table. They are perfect for cooking and serving on the table. They are 100% pure glass, so they do not release harmful substances into food, they resist very high temperatures (up to 200°C in the oven), they can be washed in the dishwasher (including seal).

Perfetti per la sterilizzazione e la pastorizzazione di qualsiasi prodotto, di frutta verdura ma anche di carne, pesce, foie gras o prodotti di salumeria. Sono indicati per servire marmellate e salse di accompagnamento: inoltre belli da vedere sulla tavola. Sono i vasetti perfetti per la vasocottura e per servire in tavola. Sono al 100% in puro vetro, quindi non rilasciano sostanze nocive nel cibo, resistono a temperature elevatissime (fino a 200°C in forno), si possono lavare in lavastoviglie (guarnizione compresa).



Set 12 glasses and cover

Set 12 vasetti con coperchio  
Gläser mit Deckel, 12er Set  
Set 12 verres avec couvercle  
12 vasos con tapa

| art.     | Ø cm. | h. cm. | ml. |
|----------|-------|--------|-----|
| 41589-08 | 6     | 5,5    | 80  |
| 41589-14 | 6     | 7,0    | 140 |



Set 12 glasses and cover

Set 12 vasetti con coperchio  
Gläser mit Deckel, 12er Set  
Set 12 verres avec couvercle  
12 vasos con tapa

| art.     | Ø cm. | h. cm. | ml. |
|----------|-------|--------|-----|
| 41589-16 | 6     | 8      | 160 |



Set 12 glasses and cover

Set 12 vasetti con coperchio  
Gläser mit Deckel, 12er Set  
Set 12 verres avec couvercle  
12 vasos con tapa

| art.     | Ø cm. | h. cm. | ml. |
|----------|-------|--------|-----|
| 41589-22 | 7     | 8      | 220 |



**Set 12 glasses and cover**

Set 12 vasetti con coperchio  
Gläser mit Deckel, 12er Set  
Set 12 verres avec couvercle  
12 vasos con tapa

| art.     | Ø cm. | h. cm. | ml. |
|----------|-------|--------|-----|
| 41589-20 | 9     | 6      | 200 |



**Set 2 glasses and cover**

Set 2 vasetti con coperchio  
Gläser mit Deckel, 2er Set  
Set 2 verres avec couvercle  
2 vasos con tapa

| art.     | Ø cm. | h. cm. | ml. |
|----------|-------|--------|-----|
| 41589-58 | 11    | 11     | 580 |



**Set 3 glasses and cover**

Set 3 vasetti con coperchio  
Gläser mit Deckel, 3er Set  
Set 3 verres avec couvercle  
3 vasos con tapa

| art.     | Ø cm. | h. cm. | ml. |
|----------|-------|--------|-----|
| 41589-37 | 11    | 7,5    | 370 |



**Set 6 bottles and cover**

Set 6 bottigliette con coperchio  
Flaschen mit Deckel, 6er Set  
Set 6 bouteilles avec couvercle  
6 botellas con tapa

| art.     | Ø cm. | h. cm. | ml. |
|----------|-------|--------|-----|
| 41589-25 | 6,5   | 14,5   | 250 |



**Set 6 bottles and cover**

Set 6 bottigliette con coperchio  
Flaschen mit Deckel, 6er Set  
Set 6 bouteilles avec couvercle  
7 botellas con tapa

| art.     | Ø cm. | h. cm. | ml. |
|----------|-------|--------|-----|
| 41589-50 | 6,5   | 19     | 500 |



**Set 6 bottles and cover**

Set 6 bottigliette con coperchio  
Flaschen mit Deckel, 6er Set  
Set 6 bouteilles avec couvercle  
8 botellas con tapa

| art.     | Ø cm. | h. cm. | ml.  |
|----------|-------|--------|------|
| 41589-99 | 6,5   | 25,5   | 1000 |



**Set 10 rubber rings**

Set 10 guarnizioni  
Gummidichtringe, 10er Set  
Set 10 joints  
Juego 10 juntas

| art.     | Ø cm. | fits/per       |
|----------|-------|----------------|
| 41589-AA | 6     | 41589-08-14-16 |
| 41589-BB | 9     | 41589-20       |
| 41589-CC | 11    | 41589-37-58    |



**Set 5 airtight covers**

Set 5 coperchi ermetici  
Frischhaltedeckel, 5er Set  
Set 5 couvercles hermétiques  
Juego 5 tapas herméticas

| art.     | Ø cm. | fits/per       |
|----------|-------|----------------|
| 41589-AC | 7     | 41589-08-14-16 |
| 41589-AC | 7     | 41589-25-50-99 |



SS

**Set 8 cover clamps**

Set 8 clip  
Deckel-Klammer 8er Set  
Set 8 clips crochets  
Juego 8 abrazaderas

| art.     |
|----------|
| 41589-AB |



**Set 12 glasses (without lid)**

Set 12 vasetti (senza coperchi)  
Gläser, 12er Set (ohne Deckel)  
Set 12 verres (sans couvercle)  
Juego 12 vasos (sin tapa)

| art.     | Ø cm. | h. cm. | ml. |
|----------|-------|--------|-----|
| 41589C08 | 6     | 5,5    | 80  |
| 41589C16 | 6     | 8,0    | 160 |



**Serving stand, chrome plated**

Supporto cromato  
Serviergestell, hartverchromt  
Présentoir, acier chromé  
Soporte, acero cromado

| art.     | Ø cm. | h. cm. | fits/per |
|----------|-------|--------|----------|
| 44840-28 | 22    | 33     | 41589-08 |

**Without glasses. – Senza vasetti.**



**Serving stand, chrome plated**

Supporto cromato  
Serviergestell, hartverchromt  
Présentoir, acier chromé  
Soporte, acero cromado

| art.     | Ø cm. | h. cm. | fits/per       |
|----------|-------|--------|----------------|
| 44840-27 | 22    | 59     | 41589-08-14-16 |

**Without glasses. – Senza vasetti.**



SS

**Insulated beverage server**

Caraffa termica  
Thermokanne  
Pot isotherme  
Jarra térmica

| art.     | lt. |
|----------|-----|
| 41650-06 | 0,6 |
| 41650-10 | 1,0 |
| 41650-13 | 1,5 |



SS

**Insulated beverage server**

Caraffa termica  
Thermokanne  
Pot isotherme  
Jarra térmica

| art.     | lt.  |
|----------|------|
| 41646-06 | 0,75 |
| 41646-10 | 1,00 |
| 41646-15 | 1,50 |
| 41646-20 | 2,00 |



SS

**Insulated beverage server**

Caraffa termica  
Thermokanne  
Pot isotherme  
Jarra térmica

| art.     | lt. |
|----------|-----|
| 42401-10 | 1,0 |
| 42401-15 | 1,5 |
| 42401-20 | 2,0 |



SS

**Insulated beverage server**

Caraffa termica  
Thermokanne  
Pot isotherme  
Jarra térmica

| art.     | lt. |
|----------|-----|
| 42405-10 | 1   |
| 42405-20 | 2   |



SS

PP

**Insulated beverage server**

Caraffa termica  
Thermokanne  
Pot isotherme  
Jarra térmica

| art.     | Ø cm. | h. cm. | lt. |
|----------|-------|--------|-----|
| 42403-01 | 16    | 20     | 1   |

8 cups. – 8 tazze.



SS

PP

**Insulated beverage server**

Caraffa termica  
Thermokanne  
Pot isotherme  
Jarra térmica

| art.     | Ø cm. | h. cm. | lt. |
|----------|-------|--------|-----|
| 42403B01 | 16    | 20     | 1   |

8 cups. – 8 tazze.



NEW

SS

**French press**

Caffettiera pressa filtro  
Kaffeebereiter  
Cafetière à piston  
Jarra para infusiones

| art.     | ml. | col. |
|----------|-----|------|
| 42407-03 | 350 | ●    |
| 42407-06 | 600 | ●    |



PC

**Water jug**

Caraffa  
Wasserkrug  
Crûche à eau  
Jarra

| art.     | Ø cm. | h. cm. | lt. |
|----------|-------|--------|-----|
| 44999-09 | 10    | 15     | 0,9 |
| 44999-16 | 12    | 20     | 1,6 |



MS

MS

**Water jug**

Caraffa  
Wasserkrug  
Crûche à eau  
Jarra

| art.     | Ø cm. | h. cm. | lt. |
|----------|-------|--------|-----|
| 44992-03 | 26    | 29     | 3   |



**Water jug**  
Caraffa  
Wasserkrug  
Crûche à eau  
Jarra

| art.     | dim. cm.  | lt. |
|----------|-----------|-----|
| 44871-28 | 12x13,8   | 0,5 |
| 44871-30 | 17,4x17   | 1,0 |
| 44871-32 | 18,7x19,8 | 1,5 |
| 44871-34 | 21,6x18,8 | 2,0 |

**Withstands temperatures/Termoresistenti da:**  
-30° +120°C.



**Lid**  
Coperchio  
Deckel  
Couvercle

**Tapa**

| art.     | dim. cm. | fits/per | U. Pack |
|----------|----------|----------|---------|
| 44871-29 | 9,9x1,4  | l. 0,5   | 10      |
| 44871-31 | 11,2x1,9 | l. 1,0   | 10      |
| 44871-33 | 14x2,4   | l. 1,5   | 10      |
| 44871-35 | 15,9x2,2 | l. 2,0   | 10      |

**Withstands temperatures/Termoresistenti da:**  
-40° +100°C.



**Water jug**  
Caraffa  
Wasserkrug  
Crûche à eau  
Jarra

| art.     | Ø cm. | h. cm. | lt. |
|----------|-------|--------|-----|
| 44994-00 | 14    | 29     | 2,5 |



**Water jug**  
Caraffa  
Wasserkrug  
Crûche à eau  
Jarra

| art.     | Ø cm. | h. cm. | lt. |
|----------|-------|--------|-----|
| 44992-02 | 16,5  | 26     | 2   |



**Juice pitcher, glass**  
Caraffa vetro  
Glas-Saftkanne  
Carafe à jus de fruits, verre  
Jarra zumo, vidrio

| art.     | Ø cm. | h. cm. | lt. |
|----------|-------|--------|-----|
| 44995-15 | 9,5   | 27     | 1,5 |

**Stainless steel lid. – Coperchio inox. -10°C/+110°C**



**Juice pitcher, glass**  
Caraffa vetro  
Glas-Saftkanne  
Carafe à jus de fruits, verre  
Jarra zumo, vidrio

| art.     | Ø cm. | h. cm. | lt. |
|----------|-------|--------|-----|
| 44995-14 | 16    | 27     | 1,4 |

**Spout opens and closes automatically. Chromed foot with cooler, keep drinks chilled up to 4 hours. – Tappo apre e chiude automaticamente. Piede cromato con eutettico, mantiene le bevande refrigerate fino a 4 ore.**



**Juice pitcher, glass**  
Caraffa vetro  
Glas-Saftkanne  
Carafe à jus de fruits, verre  
Jarra zumo, vidrio

| art.     | Ø cm. | h. cm. | lt. |
|----------|-------|--------|-----|
| 44995-10 | 9,5   | 29     | 1   |

**Spout opens and closes automatically while serving. – Tappo versatore apre e chiude automaticamente.**



**Juice pitcher with lid**  
Caraffa con coperchio  
Saftkanne mit Deckel  
Carafe à jus avec couvercle  
Jarra zumo con tapa

| art.     | Ø cm. | h. cm. | lt. |
|----------|-------|--------|-----|
| 44993-01 | 11    | 30     | 1,6 |



SS

**Tea strainer**  
Passathé  
Teesieb  
Passoire à thé  
Colador de tè

art. Ø cm.  
41529-05 5



SS

**Tea strainer**  
Passathé  
Teesieb  
Passoire à thé  
Colador de tè

art. Ø cm.  
41530-05 5



SS

**Tea strainer**  
Passathé  
Teesieb  
Passoire à thé  
Colador de tè

art. Ø cm.  
41530-11 5



SS

**Tea strainer**  
Passathé  
Teesieb  
Passoire à thé  
Colador de tè

art. Ø cm.  
41530-07 7,5



SS

**Tea strainer**  
Passathé  
Teesieb  
Passoire à thé  
Colador de tè

art. Ø cm.  
42617-04 4,5  
42617-05 5,0  
42617-06 6,5  
42617-07 7,5



SS

**Toast rack**  
Portatoast  
Toastständer  
Support pour toast  
Porta tostadas

art. dim. cm.  
41599-08 20x11x5,7



SS

**Egg cup**  
Portauovo  
Eierbecher  
Coquetier  
Soporte huevos

art. Ø cm.  
41598-00 8,5



MF

**Egg cup, 4 pcs set**  
Portauovo, set 4 pz  
Eierbecher, 4 Stk.  
Coquetier, set 4 pcs  
Soporte huevos, set 4 pz

art. Ø cm.  
41597-04 8,5



SS

PR

**Mustard cup**  
Senapiera  
Senfschale  
Moutardier  
Mostacero

art. Ø cm.  
41564-07 7



SS

PR

**Butter cup**  
Coppa burro  
Butterservierer  
Coupe à beurre  
Copa mantequilla

art. Ø cm.  
41563-07 7



SS

PR

**Butter cup**  
Coppa burro  
Butterservierer  
Coupe à beurre  
Copa mantequilla

art. Ø cm.  
41561-09 9



SS

**Insulated sauce boat**  
Salsiera termica  
Thermo-Sauciere, doppelwandig  
Saucière isotherme  
Salsera termica

art. dim. cm. lt.  
41620-04 19x12,5x13 0,4



SS

**Gravy boat with foot**

Salsiera  
Saucière mit Fuss  
Saucière sur pied  
Salsera con pie

| art.     | lt.  |
|----------|------|
| 41615-01 | 0,15 |
| 41615-03 | 0,25 |
| 41615-05 | 0,45 |



PR

**Soup bowl**

Zuppiera testa di leone  
Suppentasse Löwenkopf  
Soupière tête de lion  
Sopera cabeza de león

| art.     | Ø cm. | lt. |
|----------|-------|-----|
| 44379-05 | 17    | 0,5 |



PC

**Salad bowl**

Insalatiera  
Salatschüssel  
Saladier  
Bol para ensalada

| art.     | Ø cm. | h. cm. | lt.  |
|----------|-------|--------|------|
| 44950-15 | 15,2  | 5,0    | 0,6  |
| 44950-20 | 20,3  | 6,5    | 1,7  |
| 44950-25 | 25,4  | 8,0    | 3,0  |
| 44950-30 | 30,5  | 10,0   | 5,5  |
| 44950-38 | 38,1  | 12,5   | 10,6 |



PC

**Salad bowl**

Insalatiera  
Salatschüssel  
Saladier  
Bol para ensalada

| art.     | dim. cm. |
|----------|----------|
| 44357-10 | 24x24x10 |
| 44357-15 | 24x24x15 |



PC

**Salad bowl**

Insalatiera  
Salatschüssel  
Saladier  
Bol para ensalada

| art.     | dim. cm. |
|----------|----------|
| 44357B10 | 24x24x10 |
| 44357B15 | 24x24x15 |



SS

**Oval fruit basket**

Cesto frutta, ovale  
Obstschale, oval  
Panier à fruits, ovale  
Cesta fruta, oval

| art.     | dim. cm. |
|----------|----------|
| 42956-19 | 19x15    |
| 42956-24 | 24,5x18  |
| 42956-28 | 28x21    |



SS

**Round fruit basket**

Cesto frutta, tondo  
Obstschale, rund  
Panier à fruits, rond  
Cesta fruta, redonda

| art.     | Ø cm. |
|----------|-------|
| 41629-17 | 17,0  |
| 41629-20 | 20,0  |
| 41629-25 | 25,5  |



NEW

**Washable kraft paper bag**

Cesto pane di carta kraft lavabile  
Waschbare Kraftpapierbrottasche  
Panier en papier kraft lavable  
Cesta pan de papel kraft lavable

| art.     | Ø cm. | h. cm. |
|----------|-------|--------|
| 42879M12 | 12    | 12     |
| 42879M15 | 15    | 10     |
| 42879M22 | 22    | 13     |
| 42879M25 | 25    | 18     |





**NEW**

**Washable kraft paper bag**  
Cesto pane di carta kraft lavabile  
Waschbare Kraftpapierbrottasche  
Panier en papier kraft lavable  
Bolsa de papel kraft lavable

| art.     | Ø cm. | h. cm. |
|----------|-------|--------|
| 42879K12 | 12    | 12     |
| 42879K15 | 15    | 10     |
| 42879K22 | 22    | 13     |
| 42879K25 | 25    | 18     |



**Wire basket, cotton linen**  
Cesto in filo, fodera cotone  
Drahtkorb, Baumwollfutter  
Panier métallique, doublure en coton  
Cesta de alambre, forro de algodón

| art.     | dim. cm.   |
|----------|------------|
| 42878-17 | 17x12,5x8  |
| 42878-25 | 25x15,5x12 |



**Wire basket, cotton linen**  
Cesto in filo, fodera cotone  
Drahtkorb, Baumwollfutter  
Panier métallique, doublure en coton  
Cesta de alambre, forro de algodón

| art.     | dim. cm.  |
|----------|-----------|
| 42877-17 | 17x12,5x8 |
| 42877-25 | 25x17x12  |



**Bread basket**  
Cesta baguettes  
Brotkorb  
Corbeille à pain  
Cesta pan

| art.     | Ø cm. | h. cm. |
|----------|-------|--------|
| 42948-18 | 10    | 7      |
| 42948-20 | 20    | 7      |
| 42948-25 | 25    | 7      |



**Bread basket**  
Cesta baguettes  
Brotkorb  
Corbeille à pain  
Cesta pan

| art.     | dim. cm.  |
|----------|-----------|
| 42948-23 | 23x15x6,5 |



**Bread basket**  
Cesta baguettes  
Brotkorb  
Corbeille à pain  
Cesta pan

| art.     | Ø cm. | h. cm. |
|----------|-------|--------|
| 42935-19 | 19    | 9      |
| 42935-26 | 26    | 9      |



**Bread basket**  
Cesta baguettes  
Brotkorb  
Corbeille à pain  
Cesta pan

| art.     | Ø cm. | h. cm. |
|----------|-------|--------|
| 42944-23 | 23    | 7      |



**Bread basket**  
Cesta baguettes  
Brotkorb  
Corbeille à pain  
Cesta pan

| art.     | dim. cm. |
|----------|----------|
| 42945-27 | 27x20x10 |



**Bread basket**  
Cesta baguettes  
Brotkorb  
Corbeille à pain  
Cesta pan

| art.     | dim. cm.  |
|----------|-----------|
| 42945-18 | 18x13x6,5 |
| 42945-23 | 23x15x6,5 |



**Bread basket**  
Cesta baguettes  
Brotkorb  
Corbeille à pain  
Cesta pan

| art.     | Ø cm. | h. cm. | col.         |
|----------|-------|--------|--------------|
| 42974C13 | 13    | 10     | light beige  |
| 42974B13 | 13    | 10     | dark brown   |
| 42974M13 | 13    | 10     | medium brown |
| 42974N13 | 13    | 10     | black        |



**Round canvas bag**  
Cesto cotone, rotondo  
Brottasche, rund, Baumwolle  
Panier à pain rond, coton  
Cesta pan redonda, algodón

| art.     | Ø cm. | h. cm. |
|----------|-------|--------|
| 42875-17 | 17    | 8      |
| 42875-20 | 20    | 9      |

**Cotton, machine-washable up to 30° C.**  
Cotone, lavabile a macchina fino a 30° C.



**Round canvas bag**  
Cesto cotone, rotondo  
Brottasche, rund, Baumwolle  
Panier à pain rond, coton  
Cesta pan redonda, algodón

| art.     | Ø cm. | h. cm. |
|----------|-------|--------|
| 42875B17 | 17    | 8      |
| 42875B20 | 20    | 9      |

**Cotton, machine-washable up to 30° C.**  
Cotone, lavabile a macchina fino a 30° C.





**Oval canvas bag**

Cesto cotone, ovale  
Brottasche, oval, Baumwolle  
Panier à pain ovale, coton  
Cesta pan , algodón

| art.     | dim. cm. |
|----------|----------|
| 42876-20 | 20x15x7  |
| 42876-25 | 25x18x9  |

**Cotton, machine-washable up to 30° C.**  
Cotone, lavabile a macchina fino a 30° C.



**Oval canvas bag**

Cesto cotone, ovale  
Brottasche, oval, Baumwolle  
Panier à pain ovale, coton  
Cesta pan , algodón

| art.     | dim. cm. |
|----------|----------|
| 42876B20 | 20x15x7  |
| 42876B25 | 25x18x9  |

**Cotton, machine-washable up to 30° C.**  
Cotone, lavabile a macchina fino a 30° C.



**Round canvas bag**

Cesto cotone, rotondo  
Brottasche, rund, Baumwolle  
Panier à pain, coton  
Cesta pan, algodón

| art.     | Ø cm. | h. cm. | col. |
|----------|-------|--------|------|
| 42873-01 | 20    | 23,5   | ●    |

**Cherry stone pillow included. Easy to heat up in microwave for 90 sec. at 500 Watt.** – Cuscino in noccioli di ciliegio incluso. Scaldare in microonde per 90 secondi a 500 Watt.



**Oval bowl**

Ciotola ovale  
Schüssel, oval  
Bassine ovale  
Bol oval

| art.     | dim. cm. |
|----------|----------|
| 42931-19 | 19,5x17  |



**Truffle slicer**

Tagliatartufi  
Trüffelschneider  
Coupe-truffes  
Corta trufa

| art.     | dim. cm. | des.     |
|----------|----------|----------|
| 48237-00 | 21x8,5   | plain    |
| 48237-01 | 21x8,5   | serrated |



**Truffle slicer**

Tagliatartufi  
Trüffelschneider  
Coupe-truffes  
Corta trufa

| art.     | dim. cm. | des.     |
|----------|----------|----------|
| 48236-00 | 21x8,5   | plain    |
| 48236-01 | 21x8,5   | serrated |

**Rosewood handle.** – Manico in palissandro.



**Truffle jar**

Confezione Tuberpack  
Trüffel-Verpackung  
Réceptient à truffes  
Envasado para trufa

| art.     | Ø cm. | h. cm. |
|----------|-------|--------|
| 48237-99 | 6     | 4,5    |

**For transport and storage, prevents weight loss.**  
Per trasporto e conservazione, previene il calo di peso.



**Truffle server**

Servitartufi  
Trüffel-Service  
Service à truffes  
Servidor de trufas

| art.     | dim. cm. |
|----------|----------|
| 48237-35 | 30x20x9  |

**Chesnut wood.** – Castagno.



**Salt/pepper shaker set**

Set spargisale/pepe  
Salz- und Pfefferstreuer-Set  
Set salière et poivrier  
Juego 2 piezas sal y pimienta

| art.     | Ø cm. | h. cm. |
|----------|-------|--------|
| 42924-02 | 5     | 6,5    |



SS

**Condiment set 2 pcs**

Set 2 pz sale e pepe  
Menage, 2-teilig  
Ménagère 2 pcs  
Servicio de mesa, 2 piezas

art. dim. cm.  
42927-02 3x3x5



**Salt/pepper shaker, chrome top**

Spargisale/pepe cromato  
Salz-/Pfefferstreuer, verchromt  
Salière/poivrier, chromé  
Salero/pimentero, cromado

art. ml.  
42928-00 45



SS

**Salt/pepper shaker, set 12 pcs**

Spargisale/pepe, set 12 pz  
Salz-/Pfefferstreuer, 12 Stk.  
Salière/poivrier, set 12 pcs  
Salero/pimentero, juego 12 pz

art. Ø cm. h. cm.  
42926-12 3 9



SS

**Condiment set, 2 pcs**

Sale e pepe, 2 pezzi  
Menage, 2-teilig  
Ménagère, 2 pièces  
Servicio de mesa, 2 piezas

art. dim. cm.  
42929-01 11,5x5,5x17

**Wood base, satin polished handle.**  
Base legno, manico satinato.



SS

**Condiment set, 2 pcs**

Servizio oliera, 2 pezzi  
Menage, 2-teilig  
Ménagère, 2 pièces  
Servicio de mesa, 2 piezas

art. dim. cm.  
42929-02 16x7,5x24,5

**Wood base, satin polished handle.**  
Base legno, manico satinato.



SS

**Condiment set, 4 pcs**

Servizio oliera, 4 pezzi  
Menage, 4-teilig  
Ménagère, 4 pièces  
Servicio de mesa, 4 piezas

art. dim. cm.  
42929-03 15,5x12x24,5

**Wood base, satin polished handle.**  
Base legno, manico satinato.



SS

**Oil/vinegar sprayer, 2 pcs**

Nebulizzatore olio/acetato, 2 pz  
Öl-/Essigvernebler, 2 Stück  
Nébuliseur huile vinaigre, 2 pièces  
Nebulizador aceite/vinagre, 2 pz

art. Ø cm. h. cm. ml.  
41635-02 4 18 110





SS

**Oil and winegar stand**  
Porta olio/aceto  
Essig u. Öl-Stand  
Porte huile et vinaigre  
Soporte para aceite y vinagre  
art. dim. cm.  
66362-02 12,5x6x27



SS

**Oil and winegar stand**  
Porta olio/aceto  
Essig u. Öl-Stand  
Porte huile et vinaigre  
Soporte para aceite y vinagre  
art. dim. cm.  
41636-25 13x7x30



SS

**Condiment set, 4 pcs**  
Servizio oliera, 4 pezzi  
Menage, 4-teilig  
Ménagère, 4 pièces  
Servicio de mesa, 4 piezas  
art. dim. cm.  
41638-04 17,5x10,5x23



SS

**Condiment set, 2 pcs**  
Servizio oliera, 2 pezzi  
Menage, 2-teilig  
Ménagère, 2 pièces  
Servicio de mesa, 2 piezas  
art. dim. cm.  
41638-02 14,5x8,5x23



SS

**Condiment set, 2 pcs**  
Sale e pepe, 2 pezzi  
Menage, 2-teilig  
Ménagère, 2 pièces  
Servicio de mesa, 2 piezas  
art. dim. cm.  
41638-12 10,5x6,5x16



SS

**Condiment set, 3 pcs**  
Set sale, pepe, stecchi  
Menage, 3-teilig  
Ménagère, 3 pièces  
Servicio de mesa, 3 piezas  
art. Ø cm. h. cm.  
41638-13 10,5 16



SS

**Cheese jar**  
Formaggiera  
Käsedose  
Fromagère  
Quesera  
art. Ø cm. h. cm.  
41638-01 10,5 7



SS

**Cheese shaker**  
Spargiformaggio  
Käsestreuer  
Poudreuse à fromage  
Quesera  
art. ml.  
42921-00 360



PP

**Cutlery/breadstick basket**  
Portaposate/grissini  
Besteck-/Salzstangenkorb  
Panier à couverts/grissins  
Cesta cubiertos/grissini  
art. Ø cm. h. cm.  
42584-01 12 15



PP

**Cutlery dispenser**  
Portaposate  
Besteck-Ablage  
Panier à couverts  
Cesta portacubiertos  
art. dim. cm.  
42584-02 27x10x4,5



PP

**Cutlery dispenser**  
Portaposate  
Besteck-Ablage  
Panier à couverts  
Cesta portacubiertos  
art. dim. cm.  
42584-04 53x32,5x10



PP

**Cutlery dispenser**  
Portaposate  
Besteck-Ablage  
Panier à couverts  
Cesta portacubiertos  
art. dim. cm.  
42584-05 53x32,5x9



PP

**Cutlery dispenser**  
Portaposate  
Besteck-Ablage  
Panier à couverts  
Cesta portacubiertos

| art.     | dim. cm. | col. |
|----------|----------|------|
| 42584-06 | 26x18x15 | ●    |
| 42584-07 | 26x18x15 | ●    |



W

**Table caddy**  
Portacondimenti  
Tisch-Caddy  
Caddy de table  
Caddy de mesa

| art.     | Ø cm. | h. cm. |
|----------|-------|--------|
| 41639-17 | 17,5  | 8,5    |



W

**Cutlery dispenser**  
Portaposate  
Besteck-Ablage  
Panier à couverts  
Cesta portacubiertos

| art.     | Ø cm. | h. cm. |
|----------|-------|--------|
| 41639-11 | 11,5  | 14     |



W

**Table caddy 4 compartments**  
Portacondimenti 4 comparti  
Tisch-Caddy 4-Fächer  
Caddy de table 4 compartiments  
Caddy de mesa 4 compartimentos

| art.     | dim. cm. | col. |
|----------|----------|------|
| 41639-30 | 17x17x10 | ○    |
| 41639-31 | 17x17x10 | ●    |
| 41639-32 | 17x17x10 | ●    |

Compartments/Scomparti 7x7 cm.



W

**Table caddy 6 compartments**  
Portacondimenti 6 comparti  
Tisch-Caddy 6-Fächer  
Caddy de table 6 compartiments  
Caddy de mesa 6 compartimentos

| art.     | dim. cm. | col. |
|----------|----------|------|
| 41639-40 | 27x17x10 | ○    |
| 41639-41 | 27x17x10 | ●    |
| 41639-42 | 27x17x10 | ●    |

Compartments/Scomparti 7,5x7,5 cm.



SS

**Table-cloth clips, 4 pcs set**  
Fermatovaglia, set 4 pz  
Tischtuch Klammer, 4-Tlg  
Pinzas à nappe, 4 pièces  
Pinzas para mantel, 4 piezas

| art.     |
|----------|
| 42953-04 |

For table/Per tavoli h 3 cm.



SS

**Napkin holder**  
Legatovagliolo  
Serviettenring  
Porteserviette  
Servilletero

| art.     |
|----------|
| 42955-00 |



SS

**Dome cover**  
Cloche  
Speiseglocke  
Cloche  
Cubreplatos

| art.     | Ø cm. | h. cm. |
|----------|-------|--------|
| 41560-28 | 29    | 18     |



SS

ABS

**Pocket crumber**

Raccoglibriciole tascabile  
Krümsammler taschenformat  
Ramasse miettes de poche  
Recogemigas de bolsillo

art. dim. cm.  
42593-00 14x2,7



SS

**Table crumber**

Raccoglibriciole a tubo  
Krümsammler  
Ramasse miettes  
Pala recogemigas

art. dim. cm.  
41679-23 23,5



NEW

**Raclette maker, 4 pans**

Macchina per raclette, 4 padelle  
Raclette Tischgerät, 4 Pfannen  
Appareil à raclette, 4 poêlons  
Máquina raclette

art. dim. cm. W  
41318-00 51x10x12 600

**Non-stick upper plate for all cooking (vegetables, meats, etc.). – Piastra superiore antiaderente per tutte le cotture (verdure, carne, ecc.).**



NEW



**Raclette maker**

Macchina per raclette  
Raclette Tischgerät  
Appareil à raclette  
Máquina raclette

art. dim. cm. W  
42420-06 44,5x21,5x30 850

**Foldable model with transport hook. 2 heating ramps, adjustable height. Suitable for cheese size 1/6 to 1/3 of a wheel. In stainless steel and painted steel. – Modello pieghevole con gancio di trasporto. 2 rampe di riscaldamento, altezza regolabile. Adatto per formaggi da 1/6 a 1/3 di una forma. In acciaio inossidabile e acciaio verniciato.**



NEW



**Raclette maker**

Macchina per raclette  
Raclette Tischgerät  
Appareil à raclette  
Máquina raclette

art. dim. cm. W  
42420-08 44,5x21,5x30 850

**Tiltable and easily removable cheese holder. Heating block adjustable height. Ideal for 6-8 people, 1/2 shape. Cheese holder in stainless steel and epoxy painted steel structure. – Porta formaggio inclinabile e facilmente rimovibile. Blocco riscaldante regolabile in altezza. Ideale per 6-8 persone, 1/2 forma. Porta formaggio in acciaio inossidabile e struttura in acciaio verniciato epossidico.**



**Fondue set, copper**

Set fonduta, rame  
Fondue-Service, Kupfer  
Service à fondue, cuivre  
Servicio para fondues, cobre

art. Ø cm. h. cm.  
15430-11 16 26



**Cheese fondue set**

Set fonduta formaggio  
Käsefondue-Service  
Service à fondue fromage  
Servicio para fondues queso

art. Ø cm. h. cm.  
41311-00 20 18



**Bourguignon fondue set**

Set fonduta bourguignonne  
Bourguignonnefondue-Service  
Service à fondue bourguignonne  
Servicio para fondues bourguignonne

art. Ø cm. h. cm.  
41312-00 20 18



**Dipping forks, 6 pcs**

Set forchette, 6 pz  
6 Stk. Fonduegäbelche  
6 curettes à fondue  
6 tenedores para fondue

art. l. cm.  
15428-06 24



SS

**Stand with grill stone**

Supporto con pietra ollare  
Träger mit Kochstein  
Pierre à cuire avec support  
Soporte con piedra

art. dim. cm.  
41315-02 17x20x12



SS

**Stand with grill stone**

Supporto con pietra ollare  
Träger mit Kochstein  
Pierre à cuire avec support  
Soporte con piedra

art. dim. cm.  
41315-04 44x20x12



NEW

SS

**Table barbecue, 1 closed side**

Barbecue da tavola, da esterno  
Tischgrill, 1 geschlossene Seite  
Barbecue de table 1 foyer fermé  
Barbacoa de mesa, 1 lado cerrado

art. dim. cm. Kg.  
41313-00 33x22x20 7,3

**Also for outdoor use. Solid beech board. Can be put in the dishwasher once disassembled.**  
Anche per uso all'esterno. Tagliere in faggio massiccio. Può essere lavato in lavastoviglie una volta smontato.



NEW

SS

**Table barbecue, 2 open sides**

Barbecue da tavola, da interno  
Tischgrill, 2 offene Seiten  
Barbecue de table 2 foyers ouverts  
Barbacoa de mesa, 2 lados abiertos

art. dim. cm. Kg.  
41314-00 33x22x20 7,3

**2 open sides for indoor use. Solid beech board. Can be put in the dishwasher once disassembled. Supplied with 1 steel pan Ø cm 18 and 1 spatula.**  
2 lati aperti per uso interno. Tagliere in faggio massiccio. Può essere lavato in lavastoviglie una volta smontato. Fornito con 1 padella di ferro Ø cm 18 e 1 spatola.



SS

**Plate warmer**

Rechaud  
Speisenwärmer  
Réchaud  
Calentador de platos

art. Ø cm. h. cm.  
41317-20 20 11

**Burning time 2 hours with an average flame.**  
Tempo di combustione 2 ore a fiamma media.



SS

**Plate warmer**

Rechaud  
Speisenwärmer  
Chauffe-plats  
Calentador de platos

art. dim. cm.  
41569-33 33x18x6,5

**Aluminum plate. – Piastra in alluminio.**



W  
SS

**Plate warmer**

Rechaud  
Speisenwärmer  
Chauffe-plats  
Calentador de platos

| art.     | dim. cm.  |
|----------|-----------|
| 44251-01 | 16x16x2,5 |
| 44251-03 | 36x20x2,5 |



**Mussel pot, enamel cast-iron**

Cocotte per molluschi, ferro smaltato  
Muscheltopf, emailliertes Stahlblech  
Casserole coquillage, émaillée  
Cacerola para mejillones, esmaltada

| art.     | Ø cm. | h. cm. | lt. |
|----------|-------|--------|-----|
| 42414-05 | 13,5  | 9,0    | 0,8 |
| 42414-10 | 18,0  | 12,0   | 2,0 |
| 42414-15 | 20,0  | 13,0   | 3,0 |
| 42414-20 | 24,0  | 13,5   | 4,0 |



**Trivet, cork**

Sottopentola, sughero  
Korkuntersetzer  
Sous-plat, liège  
Posavasos de corcho

| art.     | Ø cm. |
|----------|-------|
| 42413-24 | 24    |



SS

**Stand with 4 skewers**

Supporto con 4 spiedini  
Träger mit 4 Fleischspiesen  
Support avec 4 brochettes  
Soporte con 4 brochetas

| art.     | Ø cm. | h. cm. |
|----------|-------|--------|
| 42417-22 | 22    | 46     |



SAN

**Swing table top waste bin**

Portarifiuti da tavola  
Tischeimer  
Poubelle dé table  
Papelera sobremesa, plástico

| art.     | Ø cm. | h. cm. |
|----------|-------|--------|
| 42959-13 | 12    | 18     |



SS

**Swing table top waste bin**

Portarifiuti da tavola  
Tischeimer  
Poubelle dé table  
Papelera sobremesa

| art.     | Ø cm. | h. cm. |
|----------|-------|--------|
| 42959-12 | 12    | 17     |



**Nut-cracker**

Rompinoci  
Nussknacker  
Casse-noix  
Cascanueces

| art.     |
|----------|
| 48211-00 |



SS

**Nut-cracker**

Schiaccianoci  
Nussknacker  
Casse-noix  
Cascanueces

| art.     | l. cm. |
|----------|--------|
| 48210-00 | 16     |



SS

**Lobster cracker**

Pinza aragosta  
Hummerzange  
Pince à homard  
Pinza bogavante

| art.     | l. cm. |
|----------|--------|
| 48239-00 | 20     |



**Lobster cracker, aluminum**

Pinza aragosta, alluminio  
Hummerzange, Aluminium  
Pince à homard, alu  
Pinza bogavante, aluminio

| art.     | dim. cm. |
|----------|----------|
| 48240-00 | 14,5x6,5 |



SS

**Sea urchin cutter**

Taglia ricci di mare  
Seeigel-Messer  
Coupe oursin  
Cortador de erizo de mar

| art.     | dim. cm. |
|----------|----------|
| 48286-68 | 6x22     |



SS

**Lobster pick**

Stiletto aragosta  
Hummergabel  
Curette à homard  
Tenedor bogavante

| art.     | l. cm. |
|----------|--------|
| 48238-00 | 20     |



SS

**Lobster forks**

Forchettine per aragosta  
Hummergäbelchen  
Curettes à homard  
Tenedores bogavante

| art.     | dim. cm. | U. Pack |
|----------|----------|---------|
| 41594-18 | 18       | 5       |



SS

**Picks, set 12 pcs**

Spilloncini, set 12 pz  
Stocher, 12 Stk.  
Pic-bigorneaux, set 12 pcs  
Pico-caracoles, juego 12 pz

| art.     |
|----------|
| 41594-12 |

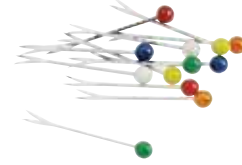

**Escargot picks, chromed, set 12 pcs**

Forchettine lumache, cromate, set 12 pz  
Schneckengabel, verchromed, 12 Stk.  
Pic-escargots, chromés, set 12 pcs  
Pico-caracoles, cromados, juego 12 pz

| art.     |
|----------|
| 41686-12 |



SS

**Escargot dish**

Piatto lumache  
Schneckenplatte  
Plat à escargots  
Plato caracoles

| art.     | comp. |
|----------|-------|
| 41687-06 | 6     |
| 41687-12 | 12    |



SS

**Caviar cooler**

Coppa caviale  
Kaviarkühler  
Rafraîchisseur à caviar  
Copa caviar

| art.     | Ø cm. | h. cm. |
|----------|-------|--------|
| 41562-18 | 18    | 5      |



**Caviar flatware, mother of pearl**

Posate caviale, madreperla  
Kaviar-Bestecke, Perlmuttern  
Couverts à caviar, nacre  
Cuberteria caviar, nácar

| art.     | dim. cm. | des.  |
|----------|----------|-------|
| 41518-00 | 11,5     | spoon |
| 41518-01 | 10,5     | knife |
| 41518-02 | 11,5     | fork  |



SS

**Oyster/fruit stand**

Alzata Royale  
Austern-/Obstständer  
Etagère Royale  
Expositor de mariscos/frutas

| art.     | Ø cm.    | h. cm. |
|----------|----------|--------|
| 41820-03 | 24-33-42 | 50     |



SS

**Oyster plate**

Piatto frutti di mare  
Austernplatte  
Plat à huîtres  
Fuente de mariscos

| art.     | Ø cm. |
|----------|-------|
| 41591-90 | 45-36 |



**Seafood display rack, chromed**

Supporto acciaio cromato  
Unterteil für Austernplatte, verchromt  
Support en fil chromé  
Soporte cromado para fuente mariscos

| art.     | Ø cm. | h. cm. |
|----------|-------|--------|
| 41593-20 | 19-25 | 20     |





**Oyster tray, aluminum**

Vassoio frutti di mare, alluminio  
Austernplatte, Aluminum  
Plat à huîtres, alu  
Fuente de mariscos, aluminio

| art.     | Ø cm. | h. cm. |
|----------|-------|--------|
| 41591-32 | 32    | 6      |
| 41591-36 | 36    | 6      |
| 41591-40 | 40    | 6      |
| 41591-45 | 45    | 6      |



**Oyster plate**

Piatto frutti di mare  
Austernplatte  
Plat à huîtres  
Fuente de mariscos

| art.     | Ø cm. | h. cm. |
|----------|-------|--------|
| 41592-36 | 36    | 4,0    |
| 41592-45 | 45    | 5,5    |

SS



**Table bag holder**

Gancio appendi borsa  
Handtaschentischhänger  
Crochet de table  
Colgador de bolso

| art.     |
|----------|
| 41559-04 |

SS



**Wine bucket table clip, chrome**

Supporto secchio da tavola, cromato  
Flaschenkühler-Tischbefestigung, verchromt  
Porte-seau à champagne, chromé  
Soporte de mesa cubo champán, cromado

| art.     |
|----------|
| 41558-00 |

Per/For: 41501-20, 41502-20.



**Wine bucket**

Secchiello vino  
Sektkühler  
Seau à champagne  
Cubo champán

| art.     | Ø cm. | h. cm. |
|----------|-------|--------|
| 41502-20 | 20    | 20     |

SS



**Champagne bucket, aluminum**

Secchiello champagne, alluminio  
Sektkühler, Aluminum  
Seau à champagne, alu  
Cubo champán, aluminio

| art.     | Ø cm. | h. cm. |
|----------|-------|--------|
| 41501-20 | 20    | 21     |



SS

**Wine cooler**

Secchiello vino  
Weinkühler  
Seau à vin  
Cubo vino

| art.     | Ø cm. | h. cm. | bot. |
|----------|-------|--------|------|
| 46120-18 | 18,5  | 16     | 1/2  |
| 46120-22 | 20,0  | 21     | 1    |
| 46120-24 | 24,0  | 22     | 2    |



SS

**White wine cooler**

Secchio vino bianco  
Weissweinkühler  
Seau à vin blanc  
Cubo vino blanco

| art.     | Ø cm. | h. cm. |
|----------|-------|--------|
| 46118-20 | 20    | 25     |



SS

**Wine cooler stand**

Colonna portasecchiello  
Ständer für Weinkühler  
Support seau à champagne  
Soporte para cubo

| art.     | Ø cm. | h. cm. |
|----------|-------|--------|
| 41505-20 | 20    | 70,5   |



SS

**Wine cooler stand**

Colonna portasecchiello  
Ständer für Weinkühler  
Support seau à champagne  
Soporte para cubo

| art.     | Ø cm. | h. cm. |
|----------|-------|--------|
| 41505-17 | 17,0  | 64,5   |
| 41505-19 | 19,5  | 64,0   |



SS

**Bottle cooler**

Glacette termica  
Flaschenkühler  
Rafraîchisseur à bouteille  
Enfriador isotérmico

| art.     | Ø cm. | h. cm. |
|----------|-------|--------|
| 41508C12 | 12/10 | 20     |



**Bottle cooler, concrete**

Glacette, cemento  
Flaschenkühler, Beton  
Rafraîchisseur à bouteille, béton  
Enfriador, cemento

| art.     | Ø cm. | h. cm. |
|----------|-------|--------|
| 41504-19 | 12/10 | 19     |



SS

**Bottle cooler**

Glacette termica  
Flaschenkühler  
Rafraîchisseur à bouteille  
Enfriador isotérmico

| art.     | Ø cm. | h. cm. |
|----------|-------|--------|
| 41504-09 | 9,5   | 22,5   |



SS

**Bottle cooler**

Glacette termica  
Flaschenkühler  
Rafraîchisseur à bouteille  
Enfriador isotérmico

| art.     | Ø cm. | h. cm. |
|----------|-------|--------|
| 41504-10 | 10    | 21     |



SS

**Bottle cooler**

Glacette termica  
Flaschenkühler  
Rafraîchisseur à bouteille  
Enfriador isotérmico

| art.     | Ø cm. | h. cm. |
|----------|-------|--------|
| 41508-10 | 10    | 30     |



PP

**Bottle cooler**

Glacette termica  
Flaschenkühler  
Rafraîchisseur à bouteille  
Enfriador isotérmico

| art.     | Ø cm.   | h. cm. |
|----------|---------|--------|
| 41504-12 | 12,5/10 | 22     |



PP

**Bottle cooler**

Glacette termica  
Flaschenkühler  
Rafraîchisseur à bouteille  
Enfriador isotérmico

| art.     | Ø cm. | h. cm. |
|----------|-------|--------|
| 41504-11 | 10    | 22     |



SAN

SS

**Bottle cooler**

Glacette termica  
Flaschenkühler  
Rafraîchisseur à bouteille  
Enfriador isotérmico

| art.     | Ø cm.    | h. cm. |
|----------|----------|--------|
| 41507-01 | 11,5/9,5 | 23     |



SS

**Wine holder**

Versavino a molla  
Weingestell  
Porte-Bouteille  
Soporte para botella

art. Ø cm.  
41510-08 8



SS

**Wine holder**

Versavino reversibile  
Weingestell  
Porte-Bouteille  
Soporte para botella

art. l. cm.  
46123-00 17



**Wine collar, chromed**

Collare salvagoccia, cromato  
Tropfenfänger, verchromt  
Collier anti-gouttes, chromé  
Anillo anti-goteo, cromado

art.  
41511-00



SS

**Wine taster**

Tastevin  
Weinprobenschale  
Tastevin  
Catador del vino

art. Ø cm.  
41499-08 8,5



**Cognac warmer, palladium**

Scaldacognac, palladio  
Cognacwärmer, Palladium  
Réchaud à cognac, palladium  
Calentador brandy, paladio

art. h. cm.  
41678-14 14,5



SS

**Pourer**

Versatore  
Ausgießer  
Verseur  
Vertedor

art.  
41511-20



**Champagne tong, chromed**

Pinza champagne, cromata  
Champagner-Zange, verchromed  
Pince à champagne, chromée  
Pinza Champaña, cromada

art.  
41511-30



**Champagne saber**

Sciabola per Sommelier  
Champagnersäbel  
Sabra à champagne  
Sable para Champán

art. l. cm.  
41496-40 40

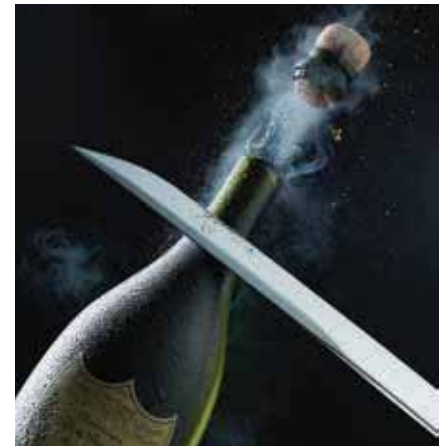

**Flower vase, nickel plated**

Vaso fiori, nichelato  
Blumenvase, vernickelt  
Vase à fleurs, nickelé  
Florero, zinc-niquel

art. Ø cm. h. cm.  
42942-16 4 16,5



SS

**Flower vase**

Vaso fiori  
Blumenvase  
Vase à fleurs  
Florero

art. h. cm.  
41628-15 15



AG

**Candlestick**

Candeliere  
Kerzenleuchter  
Chandelier  
Candelabro una vela

art. Ø cm. h. cm.  
32931-02 10 20,5



AG

**Candelabra 3 lights**

Candelabro 3 luci  
Kerzenleuchter, 3-flammig  
Chandelier, 3 branches  
Candelabro, 3 brazos

| art.     | Ø cm. | h. cm. |
|----------|-------|--------|
| 32931-03 | 10    | 22,5   |



AG

**Candelabra 5 lights**

Candelabro 5 luci  
Kerzenleuchter, 5-flammig  
Chandelier, 5 branches  
Candelabro, 5 brazos

| art.     | Ø cm. | h. cm. |
|----------|-------|--------|
| 32931-05 | 10    | 24     |



AG

**Candlestick**

Candeliere  
Kerzenleuchter  
Chandelier  
Candelabro una vela

| art.     | Ø cm. | h. cm. |
|----------|-------|--------|
| 32935-10 | 10    | 10     |
| 32935-22 | 10    | 22     |



**Candelabra 5 lights, nickel-plated**

Candelabro 5 luci, nichelato  
Kerzenleuchter, 5-flammig, vernickelt  
Chandelier, 5 branches, nickelé  
Candelabro, 5 brazos, niquelado

| art.     | Ø cm. | h. cm. |
|----------|-------|--------|
| 42443-06 | 17    | 56     |
| 42443-08 | 24    | 78     |



AG

**Candelabra 3 lights**

Candelabro 3 luci  
Kerzenleuchter, 3-flammig, vernickelt  
Chandelier, 3 branches  
Candelabro, 3 brazos

| art.     | Ø cm. | h. cm. |
|----------|-------|--------|
| 32935-03 | 11    | 25     |



AG

**Candelabra 5 lights**

Candelabro 5 luci  
Kerzenleuchter, 5-flammig  
Chandelier, 5 branches  
Candelabro, 5 brazos

| art.     | Ø cm. | h. cm. |
|----------|-------|--------|
| 32935-05 | 11    | 25     |



AG

**Candelabra 3 lights**

Candelabro 3 luci  
Kerzenleuchter, 3-flammig  
Chandelier, 3 branches  
Candelabro, 3 brazos

| art.     | Ø cm. | h. cm. |
|----------|-------|--------|
| 32936-03 | 13    | 39     |



AG

**Candelabra 5 lights**

Candelabro 5 luci  
Kerzenleuchter, 5-flammig  
Chandelier, 5 branches  
Candelabro, 5 brazos

| art.     | Ø cm. | h. cm. |
|----------|-------|--------|
| 32936-05 | 13    | 39     |



SS

**Candleholder satin finish, set 2 pcs**

Portacandela satinato, set 2 pz  
Windlicht, mattiert, 2er Set  
Bougeoir satin mat, set 2 pcs  
Portavela satinado, set 2 pz

| art.     | Ø cm. | h. cm. |
|----------|-------|--------|
| 42939-15 | 5     | 15     |



**Candleholder, chromed**

Portacandela, cromato  
Windlicht, verchromt  
Bougeoir, chromé  
Portavela, cromado

| art.     | Ø cm. | h. cm. |
|----------|-------|--------|
| 42941-22 | 11    | 22     |



**Set 4 tea light candles**

Set 4 candele tea light  
Kunstteelichter, 4er Set  
Set 4 bougies chauffeplat  
Set 4 velas de tè

| art.     | Ø cm. | h. cm. |
|----------|-------|--------|
| 42446-04 | 3,65  | 3,53   |

**Resin. Timer function 5 hours ON/19 OFF. Powered by one CR2450 alkaline battery (not incl.). Working time >50 hours. Flameless moving wick.** – Resina. Funzione timer 5 ore ON/19 OFF. 1 batteria alcalina CR2450 (non incl.). Durata > 50 ore. Stoppino mobile senza fiamma.



**Set 3 candele**

Set 3 candles  
Kunstkerzen, 3er Set  
Set 3 bougies  
Set 3 velas

| art.     | Ø cm. | h. cm. |
|----------|-------|--------|
| 42445-03 | 9     | 12,5   |
|          | 9     | 18,0   |
|          | 9     | 23,0   |

**Resin. Timer function 5 hours ON/19 OFF. Powered by 2D alkaline batteries (not incl.). Working time >800 hours. Flameless moving wick.** – Resina. Funzione timer 5 ore ON/19 OFF. 2 batterie alcaline D (non include). Durata > 800 ore. Stoppino mobile senza fiamma.



**Menu stand**

Porta menù  
Speisekartenhalter  
Porte-menu  
Portamenús

| art.     | dim. cm. |
|----------|----------|
| 42951-08 | 8x7x2    |

SS



**Table number stand, 4 pcs set**

Supporto numero tavola, set 4 pz  
Tischnummerständer, Satz 4 Stk  
Support numéro de table, set 4 pcs  
Soporte número de mesa, set 4 pz

| art.     | Ø cm. | h. cm. |
|----------|-------|--------|
| 42954-04 | 4     | 10     |

SS



**Table number stand**

Supporto numero tavola  
Tischnummerständer  
Support numéro de table  
Soporte número de mesa

| art.     | Ø cm. | h. cm. |
|----------|-------|--------|
| 42954-18 | 7,5   | 18,5   |
| 42954-29 | 7,5   | 29,0   |
| 42954-46 | 7,5   | 46,0   |

SS



**Card holder**

Supporto targhetta  
Kartenhalter  
Porte-cartes  
Portatarjetas

| art.     | dim. cm. |
|----------|----------|
| 42952-05 | 6x5x3    |

SS



**Table sign, 2 pcs set**

Targhetta tavola, set 2 pz  
Tischaufsteller, Satz 2 Stk  
Plaque de table, set 2 pcs  
Placa de mesa, set 2 pz

| art.     | dim. cm.  |
|----------|-----------|
| 42951-57 | 5,5x5x3,5 |

SS



SS

**Table sign, 2 pcs set**

Targhetta tavola, set 2 pz  
Tischaufsteller, Satz 2 Stk  
Plaque de table, set 2 pcs  
Placa de mesa, set 2 pz

| art.     | dim. cm.  |
|----------|-----------|
| 42951-59 | 5,5x5x3,5 |



SS

**Reception bell**

Campanella reception  
Receptionsschell  
Sonette de réception  
Timbre recepción

| art.     | Ø cm. | h. cm. |
|----------|-------|--------|
| 41390-00 | 8,5   | 6      |



W

**Newspaper stick**

Portagiornale  
Zeitungshalter  
Canne à journaux  
Varilla portaperiodico

| art.     | l. cm. | col. |
|----------|--------|------|
| 48287-18 | 75     | ●    |
| 48287-19 | 75     | ●    |



SS

**Ashtray**

Posacenere  
Aschenbecher  
Cendrier  
Cenicero

| art.     | Ø cm. |
|----------|-------|
| 48247-10 | 10    |



SS

**Ashtray**

Posacenere  
Aschenbecher  
Cendrier  
Cenicero

| art.     | Ø cm. | h. cm. |
|----------|-------|--------|
| 48250-10 | 10    | 4,5    |
| 48250-12 | 12    | 4,5    |



PR

**Ashtray**

Posacenere  
Aschenbecher  
Cendrier  
Cenicero

| art.     | Ø cm. |
|----------|-------|
| 44366-10 | 10    |



MF

**Ashtray, chrome plated**

Posacenere, cromato  
Aschenbecher, Metall hartverchromt  
Cendrier, chromé  
Cenicero, cromado

| art.     | Ø cm. | h. cm. |
|----------|-------|--------|
| 48249-13 | 13    | 10,5   |



MF

**Ashtray, 3 pcs set**

Posacenere, set 3 pz  
Aschenbecher, 3 Stk  
Cendrier, set 3 pièces  
Cenicero, 3 pz

| art.     | Ø cm. | h. cm. | col. |
|----------|-------|--------|------|
| 48251-03 | 8     | 3      | ●    |



MF

**Ashtray**

Posacenere  
Aschenbecher  
Cendrier  
Cenicero

| art.     | Ø cm. | h. cm. | col. |
|----------|-------|--------|------|
| 48253B09 | 9,5   | 4,5    | ●    |



MF

**Ashtray**

Posacenere  
Aschenbecher  
Cendrier  
Cenicero

| art.     | Ø cm. | h. cm. | col. |
|----------|-------|--------|------|
| 48253-09 | 9,5   | 4,5    | ○    |



MF

**Ashtray**

Posacenere  
Aschenbecher  
Cendrier  
Cenicero

| art.     | Ø cm. | h. cm. | col. |
|----------|-------|--------|------|
| 48252-10 | 10    | 4,0    | ○    |
| 48252-12 | 12    | 4,5    | ○    |



MF

**Ashtray**

Posacenere  
Aschenbecher  
Cendrier  
Cenicero

| art.     | Ø cm. | h. cm. | col. |
|----------|-------|--------|------|
| 48252B10 | 10    | 4,0    | ●    |
| 48252B12 | 12    | 4,5    | ●    |



**Table cigar cutter**  
Tagliasigari da tavola  
Zigarrenscheider  
Coupe-cigares  
Guillotina para puros

art. dim. cm.  
48244-07 9x4

**Double blad. Assorted models.**  
Doppia lama. Modelli assortiti.



**Table cigar cutter**  
Tagliasigari da tavola  
Zigarrenscheider  
Coupe-cigares  
Guillotina para puros

art. dim. cm.  
48244-04 4x4

SS



**Table cigar cutter**  
Tagliasigari da tavola  
Zigarrenscheider  
Coupe-cigares  
Guillotina para puros

art. dim. cm.  
48242-09 9x4

SS



**Cigar scissors**  
Forbice sigari  
Zigarrenschere  
Ciseaux à cigares  
Cortador para puros

art. dim. cm.  
48245-10 10x5

SS



**Cigar humidor**  
Vetrina sigari  
Zigarren-Vitrine  
Vitrine à cigares  
Vitrina para puros

art. dim. cm.  
48245-75 30x24x13

PMMA

W



**Cigar ashtray**  
Portasigaro con piattino  
Aschenbecher mit Zigarrenhalter  
Cendrier à cigares  
Cenicero para puros

art. Ø cm.  
48241-14 14,5

SS

**Holds about 50-75 cigars in relation to the cigar ring, equipped with built-in hygrometer. Cedar interior. – Per c.ca 50-75 sigari in relazione al ring del sigaro, dotato di igrometro incorporato. Interno in cedro.**



# PEUGEOT MILLS MACINE



TABLE TOP  
TAVOLA



**1810** Moulin Sous-Cratet



**1812** Scies - Saws - Sägen



**1840** 1<sup>er</sup> moulin à café  
First coffee mill  
Erste Kaffeemühle



**1874** 1<sup>er</sup> moulin à poivre de table  
First pepper mill for the table  
Erste Tisch-Pfeffermühle



**1882** Grand bi



**1890** Type 3



**1960** Peugimix



**1982** 205 un sacré numéro



**1997** 1<sup>er</sup> moulin à poivre électrique  
First electric pepper mill  
Erste elektrische Pfeffermühle



**2020** Edition 210





MECHANISMS  
MECCANISMI



PEPPER



SALT



WET SEA SALT



LONG PEPPER



CHILI PEPPER



NUTMEG



CINNAMON



FLAX SEED

**PEPPER**

Made of case-hardened steel for higher, more consistent output with fewer turns. Equipped with a helix-shaped double row of teeth that guide and hold the peppercorns for a perfect grind. The grind is essential for unlocking the full flavour of your pepper. To get the best out of your pepper grinding mechanism, we recommend to use peppercorns with a diameter of 6 mm or less. Black, white and dry green peppercorns can be ground in Peugeot pepper mills. The pink berries can be ground only if in a blend (max 15% pink) with one of these peppercorns. Dried coriander is also suitable for the pepper mechanism.

**DRY SALT**

The Peugeot salt mechanism is designed to grind cooking salt (rock salt). It is made of a special stainless steel that resists corrosion. Its shape is specifically adapted to transform dry salt crystals to a fine powder. To get the best out of your Peugeot salt grinding mechanism, you should use salt with a size of 4 mm max.

**WET SEA SALT**

For wet sea salt, a specially designed mechanism has been created because the natural consistency and moisture content do not allow the use of an ordinary salt mill. An innovative patented system enables a high-performance grind without blockage even with very humid or compressed salt. This specific mechanism is composed of 3 fins ensuring both resistance and constant output, and of a spiral that mixes the salt and guides it, ensuring a constant flow. Exclusive ceramic mechanism.

**NUTMEG**

The Peugeot nutmeg mill is equipped with a double stainless steel blade/grater and a strong claw which enables the nutmeg to be very finely ground.

**CHILI PEPPER**

The chili pepper mechanism is a Peugeot exclusive product. This patented model has a pre-cutting system and a mechanism that grinds dry chili pepper. Like the pepper grinder it has a patented treatment that protects the steel from corrosion while maintaining its sharpness and wear resistance.

**PEPE**

Realizzato in acciaio, beneficia di un trattamento che lo protegge dalla corrosione, conserva il potere tranciante e lo rende resistente all'usura. Dotato di una doppia fila di denti elicoidali che guidano i grani di pepe verso il basso. Trancia e non schiaccia i grani, per sprigionarne sottilmente sapore e profumo. Consigliamo di utilizzare grani di pepe con un diametro di 6 mm o meno. I grani di pepe neri, bianchi e verdi secchi possono essere macinati nei macinapepe Peugeot. Le bacche rosa possono essere macinate solo se in miscela (max 15% rosa). Il meccanismo del pepe è adatto anche al coriandolo essiccato.

**SALE SECCO**

Il meccanismo del sale è progettato per macinare il sale da cucina (sale grosso). È fatto di uno speciale acciaio inossidabile resistente alla corrosione. La sua forma è specificamente adattata per trasformare cristalli di sale secco in una polvere fine. Per un risultato ottimale si consiglia di usare sale con una dimensione di 4 mm max.

**SALE MARINO UMIDO**

Per il sale marino umido, è stato creato un meccanismo apposito. Un innovativo sistema brevettato consente una macinatura ad alte prestazioni senza ostruzioni anche con sale molto umido o compresso. Il meccanismo è composto da 3 alette che ne garantiscono sia la resistenza sia un rendimento costante, e di una spirale che mescola il sale e lo guida assicurandone un flusso costante. Meccanismo esclusivo in ceramica.

**NOCE MOSCATA**

La macina è dotata di una doppia lama per grattugiare in acciaio inox e di un robusto dischetto uncinato che permette di grattugiare l'intera noce molto finemente.

**PEPERONCINO**

Questo meccanismo è un prodotto esclusivo Peugeot. Il modello brevettato ha un sistema di pre-taglio e un meccanismo che permettono di macinare il peperoncino essiccato. Come il macinapepe, il meccanismo subisce un trattamento brevettato che protegge l'acciaio dalla corrosione pur mantenendo la sua affilatura e resistenza all'usura.



MECHANISMS  
MECCANISMI



**ADJUSTABLE GRINDING SYSTEM**

For electric or manual mills.

Patented precision system that enables precise grind adjustment settings. 6 pre-defined levels of grind for pepper and 6 for salt. Rotate the ring at the base of the mill and select one of the positions, each corresponding to a specific grain.

**REGOLAZIONE DELLA MACINA**

Per macine manuali ed elettriche.

Sistema brevettato che permette una regolazione predefinita della macinatura. 6 Livelli per il pepe e 6 Livelli per il sale. Ruotare l'anello alla base della macina e selezionare una delle posizioni, ognuna corrisponde ad una determinata grana.



**CLASSIC ADJUSTABLE SYSTEM**

Thumbwheel grind adjustment on electric grinders is found below the grinding mechanism. Grind adjustment nut on manual mills, turn the nut. Clockwise to obtain a finer grind, counter-clockwise to obtain a coarser grind.

**REGOLAZIONE CLASSICA**

Negli apparecchi elettrici la rotella di regolazione si trova sotto il meccanismo di macinatura. Negli apparecchi manuali la regolazione si effettua ruotando il dado/pomolino. Ruotare in senso orario per ottenere una macinatura più fine, in senso antiorario per ottenere una macinatura più grossa.



PEPPER



SALT



NEW

**EDITION 210 Pepper/salt mill**

Macina pepe/sale  
Pfeffer-/Salzmühle  
Moulin à poivre/sel  
Molinillo pimienta/sal

art-P art-S h. cm.

42686P21 42686S21 21

The iconic Paris model has been specially crafted in 210 millimeters to stylishly celebrate the brand's 210th birthday. This limited edition for 2020 features a graphical design that offers an original and contemporary interpretation of Peugeot's legacy.

L'iconico modello Paris è stato appositamente realizzato in 210 millimetri per celebrare con stile il 210° compleanno del marchio. Questa edizione limitata per il 2020 presenta un design grafico che offre un'interpretazione originale e contemporanea del patrimonio Peugeot.



NEW

SELECT  
MOULIN SUR MESURE

**PARIS ICON Pepper/salt mill**

Macina pepe/sale  
Pfeffer-/Salzmühle  
Moulin à poivre/sel  
Molinillo pimienta/sal

art-P art-S h. cm.

42687P18 42687S18 18

42687P22 42687S22 22

42687P30 42687S30 30

Walnut. – Noce



NEW

SELECT  
MOULIN SUR MESURE

**PARIS ICON Pepper/salt mill**

Macina pepe/sale  
Pfeffer-/Salzmühle  
Moulin à poivre/sel  
Molinillo pimienta/sal

art-P art-S h. cm.

42688P18 42688S18 18

42688P22 42688S22 22

42688P30 42688S30 30

Laquered black. – Laccato nero.



W

**PARIS ANTIQUE Pepper/salt mill**

Macina pepe/sale  
Pfeffer-/Salzmühle  
Moulin à poivre/sel  
Molinillo pimienta/sal

art-P art-S h. cm.

42749P18 42749S18 18

42749P22 42749S22 22

Beech wood antique. – Faggio anticato.



W

**BISTRO ANTIQUE Pepper/salt mill**

Macina pepe/sale  
Pfeffer-/Salzmühle  
Moulin à poivre/sel  
Molinillo pimienta/sal

art-P art-S h. cm.

42705P10 42705S10 10

Beech wood antique. – Faggio anticato.



W

**PARIS Pepper/salt mill**

Macina pepe/sale  
Pfeffer-/Salzmühle  
Moulin à poivre/sel  
Molinillo pimienta/sal

| art.-P   | art.-S   | h. cm. |
|----------|----------|--------|
| 42746P12 | -        | 12     |
| 42746P18 | 42746S18 | 18     |
| 42746P22 | 42746S22 | 22     |
| 42746P30 | 42746S30 | 30     |
| 42746P40 | -        | 40     |
| 42746P50 | -        | 50     |
| 42746P80 | -        | 80     |

**Beech wood, chocolate.** – Faggio cioccolato.



W

**PARIS Pepper/salt mill**

Macina pepe/sale  
Pfeffer-/Salzmühle  
Moulin à poivre/sel  
Molinillo pimienta/sal

| art.-P   | art.-S   | h. cm. |
|----------|----------|--------|
| 42747P12 | 42747S12 | 12     |
| 42747P18 | 42747S18 | 18     |

**Beech wood, black lacquered.** – Faggio laccato nero.



U  
**SELECT**  
MOÛTURE SUR MESURE

**PARIS Pepper/salt mill**

Macina pepe/sale  
Pfeffer-/Salzmühle  
Moulin à poivre/sel  
Molinillo pimienta/sal

| art.-P   | art.-S   | h. cm. |
|----------|----------|--------|
| 42665P12 | 42665S12 | 12     |
| 42665P18 | 42665S18 | 18     |
| 42665P22 | 42665S22 | 22     |
| 42665P30 | 42665S30 | 30     |
| 42665P40 | 42665S40 | 40     |

**Beech wood, natural.** – Faggio naturale.



U  
**SELECT**  
MOÛTURE SUR MESURE

**PARIS Pepper/salt mill**

Macina pepe/sale  
Pfeffer-/Salzmühle  
Moulin à poivre/sel  
Molinillo pimienta/sal

| art.-P   | art.-S   | h. cm. |
|----------|----------|--------|
| 42666P12 | 42666S12 | 12     |
| 42666P18 | 42666S18 | 18     |
| 42666P22 | 42666S22 | 22     |
| 42666P27 | 42666S27 | 27     |
| 42666P30 | 42666S30 | 30     |
| 42666P40 | 42666S40 | 40     |

**Beech wood, chocolate.** – Faggio cioccolato.



U  
**SELECT**  
MOÛTURE SUR MESURE

**PARIS Pepper/salt mill**

Macina pepe/sale  
Pfeffer-/Salzmühle  
Moulin à poivre/sel  
Molinillo pimienta/sal

| art.-P   | art.-S   | h. cm. |
|----------|----------|--------|
| 42668P12 | 42668S12 | 12     |
| 42668P18 | 42668S18 | 18     |
| 42668P22 | 42668S22 | 22     |
| 42668P30 | 42668S30 | 30     |
| 42668P40 | -        | 40     |

**Beech wood, red lacquered.** – Faggio laccato rosso.



**PARIS Pepper/salt mill**

Macina pepe/sale  
Pfeffer-/Salzmühle  
Moulin à poivre/sel  
Molinillo pimienta/sal

| art.-P   | art.-S   | h. cm. |
|----------|----------|--------|
| 42667P12 | 42667S12 | 12     |
| 42667P18 | 42667S18 | 18     |
| 42667P22 | 42667S22 | 22     |
| 42667P30 | 42667S30 | 30     |

**Beech wood, black lacquered.** – Faggio laccato nero.



**PARIS Pepper/salt mill**

Macina pepe/sale  
Pfeffer-/Salzmühle  
Moulin à poivre/sel  
Molinillo pimienta/sal

| art.-P   | art.-S   | h. cm. |
|----------|----------|--------|
| 42664P12 | 42664S12 | 12     |
| 42664P18 | 42664S18 | 18     |
| 42664P22 | 42664S22 | 22     |
| 42664P30 | 42664S30 | 30     |
| 42664P40 | -        | 40     |

**Beech wood, white lacquered.** – Faggio laccato bianco.



**PARIS CHEF Pepper/salt mill**

Macina pepe/sale  
Pfeffer-/Salzmühle  
Moulin à poivre/sel  
Molinillo pimienta/sal

| art.-P   | art.-S   | h. cm. |
|----------|----------|--------|
| 42674P18 | 42674S18 | 18     |
| 42674P22 | 42674S22 | 22     |
| 42674P30 | 42674S30 | 30     |

**Stainless steel.** – Inox.



**BISTRO CHEF Pepper/salt mill**

Macina pepe/sale  
Pfeffer-/Salzmühle  
Moulin à poivre/sel  
Molinillo pimienta/sal

| art.-P   | art.-S   | h. cm. |
|----------|----------|--------|
| 42624P10 | 42624S10 | 10     |



**BISTRO Pepper/salt mill**

Macina pepe/sale  
Pfeffer-/Salzmühle  
Moulin à poivre/sel  
Molinillo pimienta/sal

| art.-P   | art.-S   | h. cm. |
|----------|----------|--------|
| 42701-10 | 42703-10 | 10     |

**Beech wood, natural.** – Faggio naturale.



**BISTRO Pepper/salt mill**

Macina pepe/sale  
Pfeffer-/Salzmühle  
Moulin à poivre/sel  
Molinillo pimienta/sal

| art.-P   | art.-S   | h. cm. |
|----------|----------|--------|
| 42701P10 | 42703S10 | 10     |

**Beech wood, white matt.** – Faggio bianco opaco.





W

**BISTRO Pepper/salt mill**

Macina pepe/sale  
Pfeffer-/Salzmühle  
Moulin à poivre/sel  
Molinillo pimienta/sal

art.-P art.-S h. cm.  
42702-10 42704-10 10

**Beech wood, chocolate.** – Faggio cioccolato.



W

**BISTRO Pepper/salt mill**

Macina pepe/sale  
Pfeffer-/Salzmühle  
Moulin à poivre/sel  
Molinillo pimienta/sal

art.-P art.-S h. cm.  
42702P10 42704S10 10

**Beech wood, black matt.** – Faggio nero opaco.



W

**CHÂTEL Pepper/salt mill**

Macina pepe/sale  
Pfeffer-/Salzmühle  
Moulin à poivre/sel  
Molinillo pimienta/sal

art.-P art.-S h. cm.  
42707P21 42707S21 21



W

**HOSTELLERIE Pepper mill**

Macina pepe  
Pfeffermühle  
Moulin à poivre  
Molinillo pimienta

art. h. cm. col.  
42741-22 22 ●  
42742-22 22 ●



NEW

**ISEN Pepper mill**

Macina pepe  
Pfeffermühle  
Moulin à poivre  
Molinillo pimienta

art.-P art.-S h. cm.  
42682P18 42682S18 18

**Beech wood, black matt.** – Faggio nero opaco.



NEW

**ISEN Pepper mill**

Macina pepe  
Pfeffermühle  
Moulin à poivre  
Molinillo pimienta

art.-P art.-S h. cm.  
42683P18 42683S18 18

**Beech wood, natural.** – Faggio naturale.





NEW

**MERIBEL Pepper mill**

Macina pepe  
Pfeffermühle  
Moulin à poivre  
Molinillo pimienta

art-P art-S h. cm.  
42685P14 42685S14 14

**Walnut. Cap highly matt finish, body brilliant finish in an acrylic envelope protecting the wood against humidity.** – Noce. Testa finitura opaca, corpo finitura brillante racchiuso in acrilico che protegge il legno dall'umidità.



SS  
W

**ROYAN Pepper/salt mill**

Macina pepe/sale  
Pfeffer-/Salzmühle  
Moulin à poivre/sel  
Molinillo pimienta/sal

art-P art-S h. cm.  
42677P14 42677S14 14

**Beech wood.** – Faggio.



**BRASSERIE Duo, pepper/salt mill**

Duo, macinapepe/sale  
Duo, Pfeffer-/Salzmühle  
Duo, moulin à poivre/sel  
Duo, molinillo pimienta/sal

art. h. cm.  
42710-11 11

**ABS chromed/acrylic.** – ABS cromato/acrilico.



**FIDJI OLIVE Pepper/salt mill**

Macina pepe/sale  
Pfeffer-/Salzmühle  
Moulin à poivre/sel  
Molinillo pimienta/sal

art-P art-S h. cm.  
42676P15 42676S15 15  
42676P20 42676S20 20

**Stainless steel/olive wood.** – Inox/ulivo.



SS  
W

**FIDJI Pepper/salt mill**

Macina pepe/sale  
Pfeffer-/Salzmühle  
Moulin à poivre/sel  
Molinillo pimienta/sal

art-P art-S h. cm.  
42676P12 42676S12 12  
42676P15 42676S15 15  
42676P20 42676S20 20

**Beech wood, black matt.** – Faggio nero opaco.





**NEW**

**BALI FONTE Pepper mill**

Macina pepe  
Pfeffermühle  
Moulin à poivre  
Molinillo pimienta

| art.     | h. cm. | col. |
|----------|--------|------|
| 42620P03 | 8      | ●    |
| 42620P04 | 8      | ●    |

Cast iron. – Ghisa.



**NEW**

**BALI FONTE Pepper mill**

Macina pepe  
Pfeffermühle  
Moulin à poivre  
Molinillo pimienta

| art.     | h. cm. | col. |
|----------|--------|------|
| 42620P01 | 8      | ●    |
| 42620P02 | 8      | ●    |

Cast iron. – Ghisa.



**NEW**

**W**

**BAYA Pepper/salt mill**

Macina pepe/sale  
Pfeffer-/Salzmühle  
Moulin à poivre/sel  
Molinillo pimienta/sal

| art.-P   | art.-S   | h. cm. |
|----------|----------|--------|
| 42684P08 | 42684S08 | 8      |



**ABS**

**AY**

**BALI Pepper mill**

Macina pepe  
Pfeffermühle  
Moulin à poivre  
Molinillo pimienta

| art.     | h. cm. | col. |
|----------|--------|------|
| 42661-02 | 8      | ●    |
| 42661-03 | 8      | ●    |



**ABS**

**AY**

**BALI Salt mill**

Macina sale  
Salzmühle  
Moulin à sel  
Molinillo sal

| art.     | h. cm. | col. |
|----------|--------|------|
| 42661-06 | 8      | ○    |







SS  
AY  
SELECT  
MOULIN SUR MESURE

**DAMAN Pepper/salt mill**

Macina pepe/sale  
Pfeffer-/Salzmühle  
Moulin à poivre/sel  
Molinillo pimienta/sal

| art.-P   | art.-S   | h. cm. |
|----------|----------|--------|
| 42764P16 | 42764S16 | 16     |
| 42764P21 | 42764S21 | 21     |



SELECT  
MOULIN SUR MESURE

**MADRAS Pepper/salt mill**

Macina pepe/sale  
Pfeffer-/Salzmühle  
Moulin à poivre/sel  
Molinillo pimienta/sal

| art.-P   | art.-S   | h. cm. |
|----------|----------|--------|
| 42705P16 | 42705S16 | 16     |
| 42705P21 | 42705S21 | 21     |

**Beech wood chocolate/stainless steel.**  
Faggio cioccolato/innox.



AY

**CHAUMONT Pepper/salt mill**

Macina pepe/sale  
Pfeffer-/Salzmühle  
Moulin à poivre/sel  
Molinillo pimienta/sal

| art.-P   | art.-S   | h. cm. |
|----------|----------|--------|
| 42798P11 | 42798S11 | 11     |



AY

**VITTEL Pepper/salt mill**

Macina pepe/sale  
Pfeffer-/Salzmühle  
Moulin à poivre/sel  
Molinillo pimienta/sal

| art.-P   | art.-S   | h. cm. |
|----------|----------|--------|
| 42796P16 | 42796S16 | 16     |
| 42796P23 | 42796S23 | 23     |



AY

**NANCY Wet sea salt mill**

Macina per sale umido  
Mühle für Feuchtes Meersalz  
Moulin à sel humide  
Molinillo sal húmeda

| art.     | h. cm. |
|----------|--------|
| 42728S18 | 18     |



AY

**NANCY Pepper/salt mill**

Macina pepe/sale  
Pfeffer-/Salzmühle  
Moulin à poivre/sel  
Molinillo pimienta/sal

| art.-P   | art.-S   | h. cm. |
|----------|----------|--------|
| 42727-09 | 42728-09 | 9      |
| 42727-12 | 42728-12 | 12     |
| 42727-18 | 42728-18 | 18     |
| 42727-22 | 42728-22 | 22     |
| 42727-30 | 42728-30 | 30     |
| 42727-38 | 42728-38 | 38     |





AY  
W

**OLERON Wet sea salt mill**  
Macina per sale umido  
Mühle für Feuchtes Meersalz  
Moulin à sel humide  
Molinillo sal húmeda

art. h. cm.  
42670N14 14

**Beech wood.** – Faggio.



AY  
W

**OLERON Wet sea salt mill**  
Macina per sale umido  
Mühle für Feuchtes Meersalz  
Moulin à sel humide  
Molinillo sal húmeda

art. h. cm.  
42670B14 14

**Beech wood.** – Faggio.



AY

**MOLENE Wet sea salt mill**  
Macina per sale umido  
Mühle für Feuchtes Meersalz  
Moulin à sel humide  
Molinillo sal húmeda

art. h. cm.  
42670W14 14

**Beech wood.** – Faggio.



SS  
AY

**OSLO Pepper/salt mill**  
Macina pepe/sale  
Pfeffer-/Salzmühle  
Moulin à poivre/sel  
Molinillo pimienta/sal

art.-P art.-S h. cm.  
42678P14 42678S14 14



SS  
PR

**OSLO Wet sea salt mill**  
Macina per sale umido  
Mühle für Feuchtes Meersalz  
Moulin à sel humide  
Molinillo sal húmeda

art. h. cm.  
42678W14 14



AY  
W

**OLERON Pepper/salt mill**  
Macina pepe/sale  
Pfeffer-/Salzmühle  
Moulin à poivre/sel  
Molinillo pimienta/sal

art.-P art.-S h. cm.  
42662P14 42662S14 14

**Beech wood.** – Faggio.



AY  
W

**OLERON Herbs/chili mill**  
Macina erbe/peperoncino  
Kräuter-/Paprikamühle  
Moulin à herbes/piment  
Molinillo hierbas/chile

art. h. cm.  
42662C14 14

**Beech wood.** – Faggio.



SS  
AY

**OUESSANT Pepper/salt mill**

Macina pepe/sale  
Pfeffer-/Salzmühle  
Moulin à poivre/sel  
Molinillo pimienta/sal

art.-P art.-S h. cm.  
42669P14 42669S14 14



SS  
AY

**OUESSANT Herbs/chili mill**

Macina erbe/peperoncino  
Kräuter-/Paprikamühle  
Moulin à herbes/piment  
Molinillo hierbas/chile

art. h. cm.  
42669C14 14



AY  
W

**OLERON Pepper/salt mill**

Macina pepe/sale  
Pfeffer-/Salzmühle  
Moulin à poivre/sel  
Molinillo pimienta/sal

art.-P art.-S h. cm.  
42663P14 42663S14 14

**Beech wood. – Faggio.**



AY  
W

**OLERON Herbs/chili mill**

Macina erbe/peperoncino  
Kräuter-/Paprikamühle  
Moulin à herbes/piment  
Molinillo hierbas/chile

art. h. cm.  
42663C14 14

**Beech wood. – Faggio.**



SS  
AY

**DAMAN Nutmeg mill**

Macina noce moscata  
Muskatmühle  
Moulin à mouscade  
Molinillo nuez moscada

art. h. cm.  
42764M15 15

**Magnetic stopper. Compartment for 3 nutmegs.**  
Tappo magnetico. Scompartimento per 3 noci.

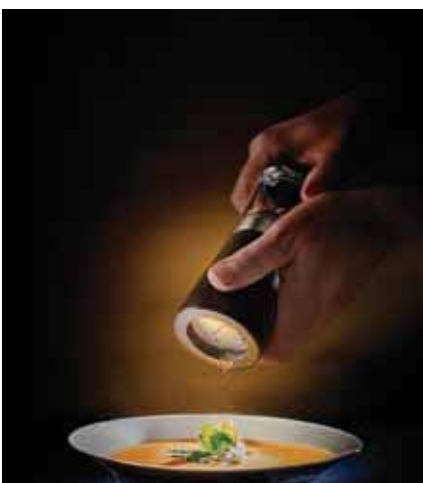

SS  
W

**MADRAS Nutmeg mill**

Macina noce moscata  
Muskatmühle  
Moulin à mouscade  
Molinillo nuez moscada

art. h. cm.  
42705M15 15

**Beech wood chocolate. Magnetic stopper.**  
**Compartment for 3 nutmegs. – Faggio cioccolato.**  
Tappo magnetico. Scompartimento per 3 noci.



AY

**TIDORE Nutmeg mill**

Macina noce moscata  
Muskatmühle  
Moulin à mouscade  
Molinillo nuez moscada

art. h. cm.  
42720-00 11

**Compartment for 7/8 nutmegs.**  
Serbatoio per 7/8 noci.





AY

ABS

**TERNATE Nutmeg mill, chromed**

Macina noce moscata, cromata  
Muskatmühle, verchromt  
Moulin à mouscade, chromé  
Molinillo nuez moscada, cromado

art. h. cm.

42720-01 11

**Compartment for 7/8 nutmegs.**  
Serbatoio per 7/8 noci.



AG

W

**PALACE Pepper/salt mill**

Macina pepe/sale  
Pfeffer-/Salzmühle  
Moulin à poivre/sel  
Molinillo pimienta/sal

art.-P art.-S h. cm.

42725P10 42725S10 10



AG

**MIGNONNETTE Pepper/salt mill**

Macina pepe/sale  
Pfeffer-/Salzmühle  
Moulin à poivre/sel  
Molinillo pimienta/sal

art.-P art.-S h. cm.

42723P10 42723S10 10



NEW

SS

**LANKA Cinnamon shaker/mill**

Macina & spargi cannella  
Zimt Shaker-/Mühle  
Shaker et moulin à cannelle  
Especiero y molinillo de canela

art. h. cm.

42685-22 22-7

**To grind cinnamon sticks (6 cm max) - 2 functions: Shaker & Mill.**  
Per macinare bastoncini di cannella (massimo 6 cm) - 2 funzioni: Shaker & macina.



W

SS

**ISEN Flax seeds mill**

Macina semi lino/sesamo  
Leinsamen-Mühle  
Moulin à graines de lin  
Molino de semillas de lino

art. h. cm.

42680-13 13

**Supplied with spoon of 5 g. and brush.**  
Fornito con un cucchiaino da 5 g. e scovolino.





**ISEN Long pepper mill**  
Macinapepe lungo  
Langer Pfeffermühle  
Moulin à poivres longs  
Molinillo de pimienta larga

art. h. cm.  
42681-16 16

**Specially designed to grind long pepper and very large peppercorns. Also works for some dry spices (cardamom, star anise, tonka bean...). Adjustable grinding. Comes with cleaning brush.**  
Appositamente progettato per macinare pepe lungo e grani di pepe molto grandi. Funziona anche con alcune spezie secche (cardamomo, anice stellato, fava tonka ...). Macinazione regolabile. Fornito con scovolino.



**ALASKA Duo, electric pepper/salt mill**  
Duo, macinapepe/sale, elettrici  
Duo, Pfeffer-/Salzmühle  
Duo, moulin à poivre/sel  
Duo, molinillo pimienta/sal

art. h. cm.  
42660-02 17

PC/Acrylic. – PC/Acrilico.



**ONYX Pepper/salt mill**  
Macina pepe/sale  
Pfeffer-/Salzmühle  
Moulin à poivre/sel  
Molinillo pimienta/sal

art-P art-S h. cm.  
42800P20 42800S20 20

Soft touch.



**ZEPHIR Pepper/salt mill**  
Macina pepe/sale  
Pfeffer-/Salzmühle  
Moulin à poivre/sel  
Molinillo pimienta/sal

art-P art-S h. cm.  
42692B14 42693B14 14

ABS stainless steel look. Soft touch.  
ABS imitazione inox. Soft touch.



**ZELI Pepper/salt mill**  
Macina pepe/sale  
Pfeffer-/Salzmühle  
Moulin à poivre/sel  
Molinillo pimienta/sal

art-P art-S h. cm.  
42801P14 42801S14 14

ABS stainless steel look. – ABS imitazione inox.



**ELIS SENSE Pepper/salt mill**  
Macina pepe/sale  
Pfeffer-/Salzmühle  
Moulin à poivre/sel  
Molinillo pimienta/sal

art-P art-S h. cm.  
42785S20 42786S20 20

Stainless steel. Incl. small dish and spice vial with funnel. – Inox. Incl. vassoietto e fiala dosatrice con imbuto.



# SERIES LIVING

TABLE TOP  
TAVOLA



A complete stainless steel line, that is able to join assortment, beauty, strength and functionality. Quality items that can be used in order to set the most charming tables and buffets, but also in order to have a well-equipped kitchen. The easiest way to serve with charm any kind of dishes: from spaghetti to meat, fish, bread, vegetables, cheese and fruit. It is also indicated for tiny preparations such as sweets, olives and pickles. Nothing will unintentionally escape!

Una linea completa capace di coniugare assortimento, bellezza, robustezza e funzionalità, realizzata in acciaio inox. Oggetti di qualità per apparecchiare le tavole ed i buffet più raffinati, ma anche per disporre quotidianamente di una cucina super-attrezzata. Il modo più pratico per servire con eleganza e facilità ogni tipo di pietanza dagli spaghetti alla carne, pesce, pane, verdure, formaggi e frutta ma anche piccoli alimenti come dolci, olive e sottaceti. Niente potrà sfuggire inavvertitamente!



**Vegetables serving plier**

Forbice per verdure  
Salad-/Gemüsezange  
Pince à légumes  
Pinza verduras

| art.     | dim. cm. |
|----------|----------|
| 12550-81 | 24       |



**Serving plier**

Forbice tutto servire  
Servierzange  
Pince à servir  
Pinza servir

| art.     | dim. cm. |
|----------|----------|
| 12550-83 | 21,0     |
| 12550-84 | 26,5     |
| 12550-85 | 24,0     |



**Pie plier**

Forbice per torta  
Kuchenzange  
Pince à tarte  
Pinza pasteles

| art.     | dim. cm. |
|----------|----------|
| 12550-80 | 28       |



**Hors-d'oeuvres and pastry plier**

Forbice per antipasti e dolci  
Vorspeisen-/Pâtisseriezange  
Pince à hors-d'oeuvres et pâtisserie  
Pinza entremeses y pasteles

| art.     | dim. cm. |
|----------|----------|
| 12550-87 | 15       |
| 12550-89 | 20       |



**Pastry plier**

Forbice per dolci  
Gebäckzange  
Pince à pâtisserie  
Pinza pasteles

| art.     | dim. cm. |
|----------|----------|
| 12550-88 | 18       |



**Grape scissor**

Forbice uva  
Traubenscher  
Ciseaux à rasin  
Tijeras uva

| art.     | dim. cm. |
|----------|----------|
| 12550-91 | 14,5     |



**Fruit tong**

Molla per frutta  
Fruchtzange  
Pince à fruits  
Pinza frutas

| art.     | dim. cm. |
|----------|----------|
| 12550-50 | 23,5     |



**Spaghetti-tong**

Molla per spaghetti  
Spaghetizzange  
Pince à spaghetti  
Pinza espagueti

| art.     | dim. cm. |
|----------|----------|
| 12550-73 | 21       |
| 12550-74 | 30       |



**Toast and pastry tong**

Molla per toast e dolci  
Toast-/Gebäckzange  
Pince à toast et tarte  
Pinza pasteles y tostadas

| art.     | dim. cm. |
|----------|----------|
| 12550-77 | 21       |
| 12550-78 | 24       |
| 12550-79 | 30       |



**Multipurpose tong**

Molla universale  
Universalzange  
Pince universelle  
Pinza universal

| art.     | dim. cm. |
|----------|----------|
| 12550-58 | 30       |



**Serving tong**

Molla tutto servire  
Servierzange  
Pince à servir  
Pinza asados y verduras

| art.     | dim. cm. |
|----------|----------|
| 12550-68 | 21       |
| 12550-69 | 26       |
| 12550-70 | 30       |





**Bread and pastry tong**

Molla per pane e pasticceria  
Brot-/Gebäckzange  
Pince à pain et pâtisserie  
Pinza pan y pasteles

| art.     | dim. cm. |
|----------|----------|
| 12550-62 | 18       |
| 12550-63 | 23       |
| 12550-64 | 26       |



**Snail tong**

Molla per lumache  
Schneckenzange  
Pince à escargots  
Pinza caracoles

| art.     | dim. cm. |
|----------|----------|
| 12550-60 | 17       |



**Asparagus tong**

Molla per asparagi  
Spargelzange  
Pince à asperges  
Pinza espárragos

| art.     | dim. cm. |
|----------|----------|
| 12550-66 | 23       |



**Ice tong**

Molla per ghiaccio  
Eiszange  
Pince à glace  
Pinza hielo

| art.     | dim. cm. |
|----------|----------|
| 12550-56 | 17,5     |



**Sugar tong**

Molla per zucchero  
Zuckerzange  
Pince à sucre  
Pinza azúcar

| art.     | dim. cm. |
|----------|----------|
| 12550-53 | 12       |



**Sugar tong**

Molla per zucchero  
Zuckerzange  
Pince à sucre  
Pinza azúcar

| art.     | dim. cm. |
|----------|----------|
| 12550-54 | 12,5     |



**Ice tong**

Molla per ghiaccio  
Eiszange  
Pince à glace  
Pinza hielo

| art.     | dim. cm. |
|----------|----------|
| 12550-55 | 18,5     |



**Cake server**

Pala torta  
Tortenheber  
Pelle à gâteau  
Pala tarta

| art.     | dim. cm. |
|----------|----------|
| 12550-02 | 30       |



**Panettone knife**

Coltello panettone  
Tortenmesser  
Couteau à gâteau  
Cuchillo tarta

| art.     | dim. cm. |
|----------|----------|
| 12550-34 | 32       |



**Serving fork**

Forchetta a servire  
Serviergabel  
Fourchette à servir  
Tenedor servir

| art.     | dim. cm. |
|----------|----------|
| 12550-11 | 29,5     |
| 12550-12 | 26,0     |
| 12550-23 | 39,0     |



**Serving spoon**

Cucchiaio a servire  
Servierlöffel  
Cuiller à servir  
Cuchara servir

| art.     | dim. cm. |
|----------|----------|
| 12550-13 | 30,0     |
| 12550-14 | 25,5     |
| 12550-22 | 39,0     |





**Serving spoon perforated**

Cucchiaio a servire forato  
Servierlöffel, perforiert  
Cuiller à servir perforée  
Cuchara servir, perforada

| art.     | dim. cm. |
|----------|----------|
| 12550-24 | 39,0     |
| 12550-25 | 25,5     |
| 12550-26 | 30,0     |



**Ladle**

Mestolo  
Schöpfer  
Louche  
Cazo

| art.     | dim. cm. |
|----------|----------|
| 12550-01 | 25,5     |



**Sauce ladle**

Coppino salsa  
Dressingschöpfer  
Louche à sauce  
Cazillo salsas

| art.     | dim. cm. |
|----------|----------|
| 12550-20 | 16       |



**Perforated sauce ladle**

Coppino forato  
Dressingschöpfer, gelocht  
Louche à sauce percée  
Cazillo, perforado

| art.     | dim. cm. |
|----------|----------|
| 12550-21 | 16,5     |



**Spaghetti serving fork**

Forchettone spaghetti  
Spaghettivorlegegabel  
Fourchette à servir spaghetti  
Tenedor servir espagueti

| art.     | dim. cm. |
|----------|----------|
| 12550-15 | 28,5     |



**Rice ladle**

Cucchiaio risotto  
Reislöffel  
Cuiller à risotto  
Cuchara arroz

| art.     | dim. cm. |
|----------|----------|
| 12550-16 | 28       |



**Meat fork**

Forchettone  
Tranchiergabel  
Fourchette  
Tenedor

| art.     | dim. cm. |
|----------|----------|
| 12550-30 | 32       |



**Roast beef knife**

Coltello arrosto  
Tranchiermesser  
Couteau à rôtis  
Cuchillo roastbeef

| art.     | dim. cm. |
|----------|----------|
| 12550-33 | 32       |



**Butter spreader**

Spatolina burro  
Butterstreicher  
Tarnineur  
Palita mantequilla

| art.     | dim. cm. | U. Pack |
|----------|----------|---------|
| 12550-37 | 16,5     | 6       |



**Salt spoon**

Cucchiaino sale  
Salzlöffel  
Cuiller à sel  
Cucharita para sal

| art.     | dim. cm. | U. Pack |
|----------|----------|---------|
| 12550-17 | 6,5      | 6       |



**Parmesan spoon**

Cucchiaio parmigiano  
Parmesanlöffel  
Cuiller à parmesan  
Cucharita parmesano

| art.     | dim. cm. | U. Pack |
|----------|----------|---------|
| 12550-18 | 12,5     | 6       |





**Ice tea spoon**

Cucchiaio bibita  
Limonadenlöffel  
Cuillère à soda  
Cuchara refresco

| art.     | dim. cm. | U. Pack |
|----------|----------|---------|
| 12550-36 | 19,5     | 6       |



**Oyster fork**

Forchettina ostriche  
Austerngabel  
Fourchette à huîtres  
Tenedor ostras

| art.     | dim. cm. | U. Pack |
|----------|----------|---------|
| 12550-43 | 14       | 6       |



**Escargot fork**

Forchetta per lumache  
Schneckengabel  
Fourchette à escargots  
Tenedor caracoles

| art.     | dim. cm. | U. Pack |
|----------|----------|---------|
| 12550-19 | 14       | 6       |



**Ice tea spoon**

Cucchiaio bibita  
Limonadenlöffel  
Cuillère à soda  
Cuchara refresco

| art.     | dim. cm. | U. Pack |
|----------|----------|---------|
| 41605-25 | 25       | 6       |



**Ice spoon**

Cucchiaio ghiaccio  
Eislöffel  
Cuillère à glace  
Cuchara hielo

| art.     | dim. cm. |
|----------|----------|
| 12550-04 | 22       |



**Dressing spoon**

Cucchiaio salsa  
Saucenlöffel  
Cuillère à sauce  
Cuchara salsa

| art.     | dim. cm. |
|----------|----------|
| 12550-06 | 22       |



**Monoportion spoon**

Cucchiaio monoporzione  
Monoporzion-Löffel  
Cuillère monoportion  
Cuchara monoporción

| art.     | dim. cm. | U. Pack |
|----------|----------|---------|
| 12550-03 | 9,5      | 6       |
| 12550-07 | 12,0     | 6       |



**Monoportion fork**

Forchetta monoporzione  
Monoporzion-Gabel  
Fourchette monoportion  
Tenedor monoporción

| art.     | dim. cm. | U. Pack |
|----------|----------|---------|
| 12550-05 | 9,5      | 6       |



**Monoportion fork**

Forchetta monoporzione  
Monoporzion-Gabel  
Fourchette monoportion  
Tenedor monoporción

| art.     | dim. cm. | U. Pack |
|----------|----------|---------|
| 12550-09 | 12       | 6       |



# DISPLAY & PRESENTATION

BUFFET





**Serving stand, chrome plated**

Supporto cromato  
Serviergestell, hartverchromt  
Présentoir, acier chromé  
Soporte platos pastre, acero cromado

art. dim. cm.

44840-01 29x17x41

**For 3 plates cm. 18x18 or 21x21.**  
Per 3 piatti cm. 18x18 oppure 21x21.



**Serving stand, chrome plated**

Supporto cromato  
Serviergestell, hartverchromt  
Présentoir, acier chromé  
Soporte platos pastre, acero cromado

art. dim. cm.

44840-02 33x21x44

**For 3 plates cm. 21x21 or 26,5x26,5.**  
Per 3 piatti cm. 21x21 oppure 26,5x26,5.



**Serving stand, chrome plated**

Supporto cromato  
Serviergestell, hartverchromt  
Présentoir, acier chromé  
Soporte platos pastre, acero cromado

art. dim. cm.

44840-03 37x21x44

**For 3 plates cm. 30x21. – Per 3 piatti cm. 30x21.**



**Serving stand, chrome plated**

Supporto cromato  
Serviergestell, hartverchromt  
Présentoir, acier chromé  
Soporte platos pastre, acero cromado

art. dim. cm.

44840-04 63x27x44,5

**For 2 plates cm. 53x32,5 or 4 plates cm. 53x16,2.**  
Per 2 piatti cm. 53x32,5 oppure 4 piatti cm. 53x16,2.



**Serving stand, chrome plated**

Supporto cromato  
Serviergestell, hartverchromt  
Présentoir, acier chromé  
Soporte platos pastre, acero cromado

art. dim. cm.

44840-05 37,5x37,5x50

**For plates in 3 different sizes: cm. 21x21-26,5x26,5-37x37. – Per piatti di 3 diverse misure: cm. 21x21-26,5x26,5-37x37.**



**Serving stand, chrome plated**

Supporto cromato  
Serviergestell, hartverchromt  
Présentoir, acier chromé  
Soporte, acero cromado

art. Ø cm. h. cm.

44840-27 22 59

**Suitable glasses/Vasetti idonei: 41589C08, 41589C16, 41589-08, 41589-14, 41589-16.**



**Serving stand, chrome plated**

Supporto cromato  
Serviergestell, hartverchromt  
Présentoir, acier chromé  
Soporte, acero cromado

art. Ø cm. h. cm.

44840-28 22 33

**Suitable glasses/Vasetti idonei: 41589C08, 41589C16, 41589-08, 41589-14, 41589-16.**



**Square bowl**

Ciotola quadra  
Schüssel, quadratisch  
Bol carré  
Bol cuadrado

art. dim. cm.

44847B09 9x9x4

44847B13 12,5x12,5x6,5

44847B20 19x19x9



MF

**Square bowl**  
Ciotola quadra  
Schüssel, quadratisch  
Bol carré  
Bol cuadrado

| art.     | dim. cm.      |
|----------|---------------|
| 44847-09 | 9x9x4         |
| 44847-13 | 12,5x12,5x6,5 |
| 44847-20 | 19x19x9       |



MF

**Round bowl**  
Ciotola tonda  
Schüssel, rund  
Bol ronde  
Bol redondo

| art.     | Ø cm. | h. cm. |
|----------|-------|--------|
| 44846B05 | 5,5   | 4,0    |
| 44846B09 | 9,0   | 4,5    |
| 44846B13 | 13,0  | 6,5    |
| 44846B15 | 15,0  | 7,5    |



MF

**Round bowl**  
Ciotola tonda  
Schüssel, rund  
Bol ronde  
Bol redondo

| art.     | Ø cm. | h. cm. |
|----------|-------|--------|
| 44846-05 | 5,5   | 4,0    |
| 44846-09 | 9,0   | 4,5    |
| 44846-13 | 13,0  | 6,5    |
| 44846-15 | 15,0  | 7,5    |



MF

**Party plate**  
Piattino fingerfood  
Fingerfood-Teller  
Petit assiette  
Platillo

| art.     | dim. cm.    | col. |
|----------|-------------|------|
| 44844-01 | 9,5x9,5x1,5 | ○    |
| 44844B01 | 9,5x9,5x1,5 | ●    |



MF

**Tray**  
Vassoio  
Tablett  
Plateau  
Bandeja

| art.     | dim. cm.    | GN  |
|----------|-------------|-----|
| 44844-11 | 53x32,5x2,5 | 1/1 |



MF

**Tray, square**  
Vassoio quadro  
Tablett, quadratisch  
Plateau carré  
Bandeja, cuadrada

| art.     | dim. cm.  |
|----------|-----------|
| 44841-18 | 18x18     |
| 44841-21 | 21x21     |
| 44841-26 | 26,5x26,5 |
| 44841-37 | 37x37     |
| 44841-51 | 51x51     |



MF

**Tray, square**  
Vassoio quadro  
Tablett, quadratisch  
Plateau carré  
Bandeja, cuadrada

| art.     | dim. cm. |
|----------|----------|
| 44841B51 | 51x51    |





**MF**

**Sushi tray**

Vassoio sushi  
Sushiplatte  
Plateau sushi  
Bandeja sushi

| art.     | dim. cm. |
|----------|----------|
| 44842B31 | 31x10,5  |
| 44842B53 | 53x18    |



**MF**

**Sushi tray**

Vassoio sushi  
Sushiplatte  
Plateau sushi  
Bandeja sushi

| art.     | dim. cm. |
|----------|----------|
| 44842-31 | 31x10,5  |
| 44842-35 | 35,5x18  |
| 44842-30 | 30x21    |
| 44842-53 | 53x18    |



**GN**

**MF**

**Tray**

Vassoio  
Tablett  
Plateau  
Bandeja

| art.     | dim. cm.  | GN  |
|----------|-----------|-----|
| 44843-11 | 53x32,5   | 1/1 |
| 44843-12 | 32,5x26,5 | 1/2 |
| 44843-24 | 53x16,2   | 2/4 |
| 44843-13 | 32,5x17,5 | 1/3 |
| 44843-14 | 26,5x16,2 | 1/4 |



**GN**

**MF**

**Tray**

Vassoio  
Tablett  
Plateau  
Bandeja

| art.     | dim. cm.  | GN  |
|----------|-----------|-----|
| 44843B11 | 53x32,5   | 1/1 |
| 44843B12 | 32,5x26,5 | 1/2 |
| 44843B24 | 53x16,2   | 2/4 |
| 44843B13 | 32,5x17,5 | 1/3 |
| 44843B14 | 26,5x16,2 | 1/4 |



**MF**

**Round dish**

Piatto tondo  
Platte, rund  
Plat rond  
Bandeja redonda

| art.     | Ø cm. |
|----------|-------|
| 44845-51 | 51    |
| 44845-30 | 30    |
| 44845-41 | 41    |



**MF**

**Bowl**

Ciotola  
Schale  
Bol  
Bol

| art.     | Ø cm. | h. cm. | ml. |
|----------|-------|--------|-----|
| 44466-07 | 7     | 6      | 50  |



**MF**

**Bowl**

Ciotola  
Schale  
Bol  
Bol

| art.     | dim. cm.  | lt.  |
|----------|-----------|------|
| 44466-11 | 7,5x7x4,5 | 0,05 |



**MF**

**Bowl**

Ciotola  
Schale  
Bol  
Bol

| art.     | dim. cm.   | lt.  |
|----------|------------|------|
| 44466-12 | 11,5x7,5x3 | 0,06 |



**MF**

**Bowl**

Ciotola  
Schale  
Bol  
Bol

| art.     | dim. cm.   | lt.  |
|----------|------------|------|
| 44466-13 | 11,5x6x5,5 | 0,04 |



**MF**

**Bowl**

Ciotola  
Schale  
Bol  
Bol

| art.     | dim. cm. | lt.  |
|----------|----------|------|
| 44466-14 | 8,5x7x6  | 0,07 |



**MF**

**Bowl**

Ciotola  
Schale  
Bol  
Bol

| art.     | dim. cm. | lt. |
|----------|----------|-----|
| 44466-15 | 8x8x4    | 0,1 |



**MF**

**Bowl**

Ciotola  
Schale  
Bol  
Bol

| art.     | dim. cm. | lt. |
|----------|----------|-----|
| 44466-16 | 35x4,5x3 | 0,2 |



MF

**Party spoon**

Cucchiaio finger-food  
Finger-food-Löffel  
Cuiller  
Cucharita

| art.     | dim. cm. | col. |
|----------|----------|------|
| 44850-11 | 11x4,3   | ○    |
| 44850B11 | 10x4,5   | ●    |



MF

**Party spoon**

Cucchiaio finger-food  
Finger-food-Löffel  
Cuiller  
Cucharita

| art.     | dim. cm. | col. |
|----------|----------|------|
| 44850-13 | 13,5x4,5 | ○    |
| 44850B13 | 13,5x4,5 | ●    |



MF

**Party spoon**

Cucchiaio finger-food  
Finger-food-Löffel  
Cuiller  
Cucharita

| art.     | dim. cm. | col. |
|----------|----------|------|
| 44850-12 | 10x4,5x1 | ○    |
| 44850B12 | 10x4,5x1 | ●    |
| 44850G12 | 10x4,5x1 | ●    |



MF

**Party spoon**

Cucchiaio finger-food  
Finger-food-Löffel  
Cuiller  
Cucharita

| art.     | dim. cm. |
|----------|----------|
| 44851-01 | 14,5x4,5 |



MF

**Party spoon**

Cucchiaio finger-food  
Finger-food-Löffel  
Cuiller  
Cucharita

| art.     | dim. cm. | col. |
|----------|----------|------|
| 44851-02 | 14,5x4,5 | ○    |
| 44851-03 | 14,5x4,5 | ●    |



MF

**Spoon, set 6 pcs**

Cucchiaio, set 6 pz  
Löffel, 6er Set  
Cuiller, set 6 pcs  
Cuchara, set 6 pz

| art.     | dim. cm. | col. |
|----------|----------|------|
| 44850-00 | 6x23     | ○    |
| 44850W00 | 6x23     | ○    |
| 44850B00 | 6x23     | ●    |



PVD

SS

**Party spoon**

Cucchiaio gourmet  
Gourmet-Löffel  
Cuiller gourmet  
Cuchara gourmet

| art.     | l. cm. | col. |
|----------|--------|------|
| 42988-99 | 13,5   | ●    |
| 42988C99 | 12,0   | ●    |
| 42988G99 | 12,0   | ●    |



MF

**Bowl oval**

Pirofila ovale  
Schale, oval  
Plat oval  
Fuente ovale

| art.     | dim. cm.  | lt. |
|----------|-----------|-----|
| 44849-27 | 27x17x4   | 0,8 |
| 44849-34 | 34x21x4,5 | 1,3 |
| 44849-47 | 47x29x5   | 3,2 |





MF

**Bowl**  
Insalatiera  
Schüssel  
Saladier  
Bol

art.            Ø cm.    h. cm.  
44836-30    30        10



MF

**Bowl**  
Insalatiera  
Schüssel  
Saladier  
Bol

art.            dim. cm.  
44834-03    40x18,5x10



MF

**Plate**  
Piatto  
Platte  
Plaque  
Plato

art.            dim. cm.  
44835-36    36x16x3  
44835-45    45x24x3  
44835-53    53x29x3,5



MF

**Plate**  
Piatto  
Platte  
Plaque  
Plato

art.            dim. cm.  
44834-00    34,5x8x2,5



MF

**Plate**  
Piatto  
Platte  
Plaque  
Plato

art.            dim. cm.  
44834-01    40x18,5x3,5  
44834-02    52x25x4



MF

**Bowl**  
Insalatiera  
Schüssel  
Saladier  
Bol

art.            dim. cm.  
44834G03    40x18,5x10



MF

**Bowl**  
Insalatiera  
Schüssel  
Saladier  
Bol

art.            Ø cm.    h. cm.  
44836G30    30        10



MF

**Plate**  
Piatto  
Platte  
Plaque  
Plato

art.            dim. cm.  
44835G36    36x16x3  
44835G45    45x24x3  
44835G53    53x29x3,5



MF

**Plate**  
Piatto  
Platte  
Plaque  
Plato

art.            dim. cm.  
44834G00    34,5x8x2,5



MF

**Plate**  
Piatto  
Platte  
Plaque  
Plato

art.            dim. cm.  
44834G01    40x18,5x3,5  
44834G02    52x25x4



TAO MELAMINE



Mirror shiny inside, outside matt.

Interno lucido, esterno satinato.



**Bowl**  
Ciotola  
Schale  
Bol  
Bol

| art.     | dim. cm.     | lt. | col. |
|----------|--------------|-----|------|
| 44449-32 | 32,5x17,5x10 | 1,8 | ○    |
| 44449B32 | 32,5x17,5x10 | 1,8 | ●    |



**Bowl**  
Ciotola  
Schale  
Bol  
Bol

| art.     | dim. cm.     | lt. | col. |
|----------|--------------|-----|------|
| 44449-30 | 30,5x30,5x10 | 3,3 | ○    |
| 44449B30 | 30,5x30,5x10 | 3,3 | ●    |



**Bowl**  
Ciotola  
Schale  
Bol  
Bol

| art.     | dim. cm.      | col. |
|----------|---------------|------|
| 44446-10 | 10,5x10x6,5   | ○    |
| 44446-14 | 13,5x12,5x8,5 | ○    |
| 44446-18 | 17x16x10,5    | ○    |



**Bowl**  
Ciotola  
Schale  
Bol  
Bol

| art.     | dim. cm.      | col. |
|----------|---------------|------|
| 44446B10 | 10,5x10x6,5   | ●    |
| 44446B14 | 13,5x12,5x8,5 | ●    |
| 44446B18 | 17x16x10,5    | ●    |



**Tray**  
Vassoio  
Tablett  
Plateau  
Bandeja

| art.     | dim. cm.  | col. |
|----------|-----------|------|
| 44842-31 | 31x10,5x2 | ○    |
| 44842B31 | 31x10,5x2 | ●    |





Withstands temperatures from -20°C to +70°C.

Termoresistenti da -20°C a +70°C.



**Platter**

Plancia  
Tablett  
Plateau  
Bandeja

| art.     | dim. cm.    | GN  |
|----------|-------------|-----|
| 44470-11 | 53,0x32,5x1 | 1/1 |
| 44470-24 | 53,0x16,2x1 | 2/4 |
| 44470-12 | 32,5x26,5x1 | 1/2 |
| 44470-13 | 32,5x17,5x1 | 1/3 |
| 44470-14 | 26,5x16,5x1 | 1/4 |



**Serving board**

Tagliere  
Servier-Brett  
Planche  
Tabla

| art.     | Ø cm. | h. cm. |
|----------|-------|--------|
| 44470-30 | 30    | 1      |
| 44470-40 | 40    | 1      |



**Bowl**

Ciotola  
Schüssel  
Bol  
Bol Ensalada

| art.     | dim. cm. | lt. |
|----------|----------|-----|
| 44470-03 | 19x19x9  | 1,5 |
| 44470-04 | 25x25x12 | 3,8 |



**Platter**

Plancia  
Tablett  
Plateau  
Bandeja

| art.     | dim. cm. |
|----------|----------|
| 44470-73 | 20x10x2  |
| 44470-74 | 30x10x2  |
| 44470-75 | 30x15x2  |

GLOBAL MELAMINE



**Bowl**  
Ciotola  
Schale  
Bol  
Bol

| art.     | dim. cm.     |
|----------|--------------|
| 44889-32 | 32,5x32,5x12 |
| 44889-35 | 35x35x12,5   |
| 44889-40 | 40x40x14     |



**Bowl**  
Ciotola  
Schale  
Bol  
Bol

| art.     | Ø cm. | h. cm. |
|----------|-------|--------|
| 44888-32 | 32    | 16,5   |
| 44888-35 | 35    | 17,0   |
| 44888-40 | 40    | 17,5   |



**Bowl**  
Ciotola  
Schale  
Bol  
Bol

| art.     | dim. cm.     | lt. |
|----------|--------------|-----|
| 44882-35 | 35,5x31,5x14 | 2,5 |
| 44882-46 | 46x40x18,5   | 5,5 |



**Plate**  
Piatto  
Teller  
Assiette  
Plato

| art.     | Ø cm. | h. cm. |
|----------|-------|--------|
| 44477-24 | 11,0  | 2      |
| 44477-25 | 16,0  | 2      |
| 44477-26 | 19,5  | 2      |
| 44477-27 | 24,0  | 2      |
| 44477-28 | 28,0  | 2      |



**Bowl**  
Ciotola  
Schüssel  
Bol  
Bol

| art.     | Ø cm. | h. cm. | lt.  |
|----------|-------|--------|------|
| 44477-40 | 7,5   | 3,0    | 0,04 |
| 44477-41 | 7,5   | 6,5    | 0,13 |
| 44477-44 | 23,0  | 3,0    | 0,40 |

Picture/Foto: 44477-24 + 44477-41.



**Bowl**  
Ciotola  
Schüssel  
Bol  
Bol

| art.     | dim. cm.      | lt.  |
|----------|---------------|------|
| 44477-52 | 7,5x7,5x3     | 0,05 |
| 44477-53 | 7,5x7,5x6,5   | 0,16 |
| 44477-54 | 15,5x15,5x3   | 0,19 |
| 44477-55 | 15,5x15,5x6,5 | 0,85 |



**Bowl**  
Ciotola  
Schüssel  
Bol  
Bol

| art.     | dim. cm.     | lt.  |
|----------|--------------|------|
| 44477-64 | 15,5x7,5x3   | 0,10 |
| 44477-65 | 15,5x7,5x6,5 | 0,40 |
| 44477-66 | 15,5x9,5x3   | 0,15 |
| 44477-67 | 15,5x9,5x6,5 | 0,50 |
| 44477-68 | 25x15,5x3    | 0,30 |
| 44477-69 | 25x15,5x6,5  | 1,40 |





**Tray**  
Vassoio  
Tablett  
Plateau  
Bandeja

| art.     | dim. cm.    | GN  |
|----------|-------------|-----|
| 44477-76 | 53x32,5x3   | 1/1 |
| 44477-77 | 32,5x26,5x3 | 1/2 |
| 44477-78 | 32,5x17,6x3 | 1/3 |
| 44477-79 | 26,5x16,2x3 | 1/4 |
| 44477-80 | 35,4x32,5x3 | 2/3 |
| 44477-81 | 53x16,2x3   | 2/4 |

Picture/Foto: 44477-52, -53, -66, -77.



**Bowl**

Ciotola

Schüssel

Bol

Bol

| art.     | Ø cm. | h. cm. | lt. |
|----------|-------|--------|-----|
| 41446-18 | 18    | 9,5    | 1,0 |
| 41446-23 | 23    | 12,5   | 2,2 |

**Concrete. – Cemento.**



**Bowl**

Ciotola

Schüssel

Bol

Bol

| art.     | Ø cm. | h. cm. | lt. |
|----------|-------|--------|-----|
| 41445-22 | 22,0  | 10,5   | 1,1 |
| 41445-26 | 26,0  | 13,0   | 1,7 |
| 41445-30 | 29,5  | 14,5   | 2,5 |

**Concrete. – Cemento.**

## BUFFET DISPLAY & PRESENTATION



**Stand chromed**  
Alzata cromata  
Ständer, verchromt  
Support chromé  
Soporte cromado

| art.     | dim. cm.            |
|----------|---------------------|
| 44840-50 | 53x32,5-53x16,5     |
| 44840-51 | 32,5x26,5-26,5x16,2 |
| 44840-52 | 32,5x17,5-35,4x32,5 |



**Stand**  
Alzata  
Ständer  
Support  
Soporte

| art.     | dim. cm.            |
|----------|---------------------|
| 44840-55 | 53x32,5-53x16,5     |
| 44840-56 | 32,5x26,5-26,5x16,2 |
| 44840-57 | 32,5x17,5-35,4x32,5 |

**Black coating. – Rivestimento nero.**

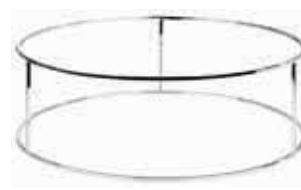

**Stand chromed**  
Alzata cromata  
Ständer, verchromt  
Support chromé  
Soporte cromado

| art.     | Ø cm. | h. cm. |
|----------|-------|--------|
| 44478-77 | 38,0  | 16,5   |
| 44478-79 | 48,5  | 16,5   |

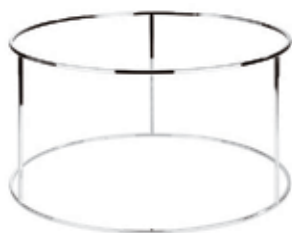

**Stand chromed**  
Alzata cromata  
Ständer, verchromt  
Support chromé  
Soporte cromado

| art.     | Ø cm. | h. cm. |
|----------|-------|--------|
| 44478-78 | 38,0  | 27     |
| 44478-80 | 48,5  | 27     |



**Tray**  
Vassoio  
Tablett  
Plateau  
Bandeja

| art.     | Ø cm. | h. cm. |
|----------|-------|--------|
| 44478-70 | 30,0  | 3      |
| 44478-71 | 38,0  | 3      |
| 44478-72 | 48,5  | 3      |





**W**

**Tray**

Vassoio  
Tablett  
Plateau  
Bandeja

| art.     | Ø cm. | h. cm. |
|----------|-------|--------|
| 44478-73 | 38,0  | 2,5    |
| 44478-74 | 48,5  | 2,5    |



**W**

**Intermediate tray**

Vassoio intermedio  
Zwischenplatte  
Plateau intermédiaire  
Bandeja intermedia

| art.     | Ø cm. | h. cm. |
|----------|-------|--------|
| 44478-75 | 38,0  | 2,5    |
| 44478-76 | 48,5  | 2,5    |



**FE**

**Stand**

Alzata  
Ständer  
Support  
Soporte

| art.     | h. cm. |
|----------|--------|
| 44840-30 | 8      |
| 44840-31 | 12     |
| 44840-32 | 18     |

**Black anti-slide coating.**  
Rivestimento antiscivolo nero.



**FE**

**Stand**

Alzata  
Ständer  
Support  
Soporte

| art.     | Ø cm.   | h. cm. |
|----------|---------|--------|
| 44840-40 | 15,5-18 | 8      |
| 44840-41 | 15,5-18 | 10     |
| 44840-42 | 15,5-18 | 18     |

**Black anti-slide coating.**  
Rivestimento antiscivolo nero.

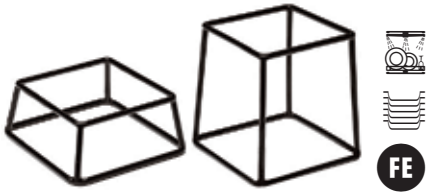

**Stand**  
Alzata  
Ständer  
Support  
Soporte

| art.     | dim. cm. |
|----------|----------|
| 44840-08 | 18x18x8  |
| 44840-10 | 18x18x10 |
| 44840-18 | 18x18x18 |

**Black anti-slide coating.**  
Rivestimento antiscivolo nero.



**Basket**  
Cesto  
Korb  
Panier  
Cesta

| art.     | Ø cm.   | h. cm. |
|----------|---------|--------|
| 44476-20 | 21-16,5 | 21     |



**Stand/basket**  
Alzata/cesto  
Ständer/Korb  
Support/panier  
Soporte/cesta

| art.     | Ø cm. | h. cm. |
|----------|-------|--------|
| 44476-26 | 21    | 10,5   |
| 44476-28 | 21    | 20,0   |



**Stand/basket**  
Alzata/cesto  
Ständer/Korb  
Support/panier  
Soporte/cesta

| art.     | Ø cm. | h. cm. | col. |
|----------|-------|--------|------|
| 44476-27 | 21    | 10,5   | ●    |
| 44476-29 | 21    | 20,0   | ●    |



**Stand/basket**  
Alzata/cesto  
Ständer/Korb  
Support/panier  
Soporte/cesta

| art.     | Ø cm.  | h. cm. | col. |
|----------|--------|--------|------|
| 44476-51 | 10,5-8 | 8      | ●    |



**Stand/basket**  
Alzata/cesto  
Ständer/Korb  
Support/panier  
Soporte/cesta

| art.     | Ø cm.  | h. cm. | col. |
|----------|--------|--------|------|
| 44476-52 | 10,5-8 | 8      | ●    |



**Stand/basket**  
Alzata/cesto  
Ständer/Korb  
Support/panier  
Soporte/cesta

| art.     | Ø cm.  | h. cm. | col. |
|----------|--------|--------|------|
| 44476-53 | 10,5-8 | 8      | ●    |



**Stand/basket chromed**  
Alzata/cesto cromato  
Ständer/Korb, verchromt  
Support/panier, chromé  
Soporte/cesta cromado

| art.     | Ø cm. | h. cm. |
|----------|-------|--------|
| 44476-30 | 15    | 10,5   |
| 44476-31 | 21    | 20,0   |



**Stand/basket**  
Alzata/cesto  
Ständer/Korb  
Support/panier  
Soporte/cesta

| art.     | Ø cm. | h. cm. | col. |
|----------|-------|--------|------|
| 44476-32 | 15    | 10,5   | ●    |
| 44476-33 | 21    | 20,0   | ●    |



**Buffet display, 3 pcs set**  
Display per buffet, set 3 pz  
Buffetgestell, 3er Set  
Etagère à buffet, set 3 pcs  
Expositor para buffet, set 3 pz

| art.     | dim. cm. |
|----------|----------|
| 41919-03 | 40x18x4  |
| 41919-03 | 40x20x8  |
| 41919-03 | 40x22x12 |

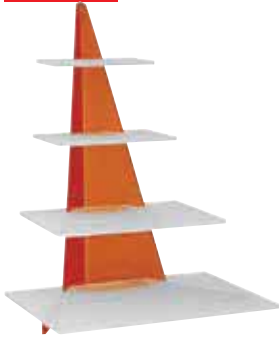

**Buffet diplay**

Display per buffet  
Büffetgestell  
Etagère à buffet  
Expositor para buffet

art. dim. cm.  
41870-01 54x47x63

**Shelves/Ripiani: 47x34 - 37x25 - 27x17 - 23x13 cm.**



**Buffet diplay**

Display per buffet  
Büffetgestell  
Etagère à buffet  
Expositor para buffet

art. Ø cm. h. cm.  
41870-03 28 29

**Shelves/Ripiani: 38x30x21 - 38x30x13 - 38x30x5 cm.**

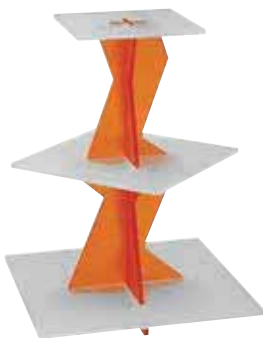

**Buffet diplay**

Display per buffet  
Büffetgestell  
Etagère à buffet  
Expositor para buffet

art. dim. cm.  
41870-02 40x40x53

**Shelves/Ripiani: 40x40 - 30x30 - 22x22 - 27x17 - 23x13 cm.**



**Buffet diplay**

Display per buffet  
Büffetgestell  
Etagère à buffet  
Expositor para buffet

art. dim. cm.  
41870-04 40x27x29

**Shelves/Ripiani: 40x27x21 - 40x27x13 - 40x27x5 cm.**





SS

**Fruit stand, 3 tiers**

Alzata frutta, 3 piani  
Obstständler, 3-stöckig  
Étagère à fruits, 3 étages  
Frutero 3 pisos

| art.     | Ø cm.    | h. cm. |
|----------|----------|--------|
| 42940-03 | 32-38-48 | 50     |



**Wedding cake stand, aluminum**

Alzata per torte, alluminio  
Hochzeitstortenständler, Aluminium  
Support pour tourte de mariage, alu  
Pedestal para tartas, aluminio

| art.     | Ø cm.          |
|----------|----------------|
| 47100-03 | 20-26-32       |
| 47100-04 | 20-26-32-40    |
| 47100-05 | 20-26-32-40-45 |

**Distance between tiers 16,5 cm.**  
Distanziali h. 16,5 cm.



**Wedding cake stand, aluminum**

Alzata per torte, alluminio  
Hochzeitstortenständler, Aluminium  
Support pour tourte de mariage, alu  
Pedestal para tartas, aluminio

| art.     | Ø cm.                   |
|----------|-------------------------|
| 47100-06 | 20-26-32-40-45-50       |
| 47100-07 | 16-20-26-32-40-45-50    |
| 47100-08 | 16-20-26-32-40-45-50-55 |

**Distance between tiers 16,5 cm.**  
Distanziali h. 16,5 cm.



SS

**Lightning column**

Colonna luminosa  
Lichtsäule  
Socle lumineux  
Columna luminosa

| art.     | Ø cm. | h. cm. |
|----------|-------|--------|
| 42979-00 | 30    | 21     |

**Stainless steel base plate ø30 cm., PMMA column, LED-light box and remote control.**  
Base inox ø cm 30, colonna PMMA, scatola luci-LED con telecomando.



SS

**Oyster plate**

Piatto frutti di mare  
Austernplatte  
Plat à huîtres  
Fuente de mariscos

| art.     | Ø cm. | h. cm. |
|----------|-------|--------|
| 42979-36 | 36    | 4,5    |

**The plate has a centering element which keeps it anchored to the column.**



SS

**Oyster plate**

Piatto frutti di mare  
Austernplatte  
Plat à huîtres  
Fuente de mariscos

| art.     | Ø cm. | h. cm. |
|----------|-------|--------|
| 42979-45 | 45    | 5,5    |

**Sotto il piatto è fissato un elemento di centraggio che lo mantiene ancorato alla colonna luminosa.**



NEW

SS

**Chocolate fountain**

Fontana cioccolato  
Schokoladenbrunnen  
Fontaine à chocolat  
Fuente para chocolate

| art.     | Ø cm. | h. cm. | lt. | W   |
|----------|-------|--------|-----|-----|
| 42982-08 | 38    | 80     | 3,5 | 370 |

**230V-50Hz-Amps 1,6A. Minimum quantity of chocolate necessary for operation is about 3.5 kg, the maximum is 8 kg. –** Quantità minima di cioccolato richiesta per funzionare è di circa 3,5 kg e può contenerne fino a 8 kg.



SS

**Cocktail fountain**

Fontana cocktails  
Cocktails-Laufbrunnen  
Fontaine à cocktails  
Fuente cocktail

| art.     | Ø cm. | h. cm. | lt. |
|----------|-------|--------|-----|
| 42981-73 | 42    | 56     | 15  |

**10W 220V. NOT recommend for use with fizzy drinks or champagne. –** Prodotto NON consigliato per liquidi gasati o champagne.





**SS**

**Champagne Waterfall**

Cascata champagne  
Sekt Wasserfall  
Cascade à champagne  
Cascada champañã

| art.     | Ø cm. | h. cm. |
|----------|-------|--------|
| 42980-01 | 45    | 64     |

**LED lighting multicolor cycle. For 42 champagne cups.** – Illuminazione led a ciclo multicolore. Per 42 coppe champagne.



**SS**

**Champagne Waterfall**

Cascata champagne  
Sekt Wasserfall  
Cascade à champagne  
Cascada champañã

| art.     | Ø cm. | h. cm. |
|----------|-------|--------|
| 42980-02 | 45    | 107    |

**LED lighting multicolor cycle. For 73 champagne cups.** – Illuminazione led a ciclo multicolore. Per 73 coppe champagne.



**PC**

**Punch bowl**

Coppa punch  
Punchbowle  
Rafraîchisseur  
Ponchero

| art.     | Ø cm. | lt. |
|----------|-------|-----|
| 41541-44 | 44    | 15  |

**Stainless steel bottom ring. – Piede inox.**



**SS**

**Punch bowl**

Coppa punch  
Punchbowle  
Rafraîchisseur  
Ponchero

| art.     | Ø cm. | lt.  |
|----------|-------|------|
| 11956-37 | 36    | 9,5  |
| 11956-42 | 42    | 15,0 |



**AY**

**Big party tub**

Secchio portabottiglie  
Flaschenkühler-Bowle  
Rafraîchisseur à bouteilles  
Ponchero

| art.     | dim. cm. |
|----------|----------|
| 44946-04 | 40x28x23 |



**AY**

**Big party tub**

Secchio portabottiglie  
Flaschenkühler-Bowle  
Rafraîchisseur à bouteilles  
Ponchero

| art.     | dim. cm. |
|----------|----------|
| 44946B05 | 35x35x20 |



ACRYLIC MIRRORS  
SPECCHI ACRILICI PMMA



**Mirror, square**  
Specchio quadrato  
Spiegel, quadratisch  
Miroir carré  
Espejo cuadrado

| art.     | dim. cm. |
|----------|----------|
| 41885-30 | 30x30    |
| 41885-40 | 40x40    |
| 41885-45 | 45x45    |
| 41885-50 | 50x50    |
| 41885-60 | 60x60    |



**Mirror, oval**  
Specchio ovale  
Spiegel, oval  
Miroir ovale  
Espejo oval

| art.     | dim. cm. |
|----------|----------|
| 41877-45 | 45x30    |
| 41877-61 | 61x45,5  |
| 41877-81 | 81x61    |
| 41877-99 | 100x70   |



**Mirror, rectangular**  
Specchio rettangolare  
Spiegel, rechteckig  
Miroir rectangulaire  
Espejo rectangular

| art.     | dim. cm. |
|----------|----------|
| 41878-45 | 45x30    |
| 41878-61 | 61x46    |
| 41878-81 | 81x58,5  |
| 41878-99 | 100x70   |





**Mirror, octagon**  
Specchio ottagon  
Spiegel, achteckig  
Miroir octogonal  
Espejo octogonal

| art.     | Ø cm. |
|----------|-------|
| 41879-30 | 30    |
| 41879-40 | 40    |
| 41879-50 | 50    |
| 41879-61 | 61    |



**Mirror, hexagon**  
Specchio esagon  
Spiegel, Sechseck  
Miroir hexagon  
Espejo hexágono

| art.     | Ø cm. |
|----------|-------|
| 41880-38 | 38    |
| 41880-61 | 61    |



**Mirror, comma**  
Specchio virgola  
Spiegel, Komma  
Miroir virgule  
Espejo vírgula

| art.     | Ø cm. |
|----------|-------|
| 41875-40 | 40,6  |
| 41875-61 | 61,0  |



**Mirror, segment**  
Specchio spicchio  
Spiegel, Segment  
Miroir quartier  
Espejo segmento

| art.     | Ø cm. |
|----------|-------|
| 41881-30 | 30,5  |
| 41881-40 | 40,5  |



**Mirror, circle**  
Specchio cerchio  
Spiegel, Kreis  
Miroir cercle  
Espejo aro

| art.     | Ø cm. |
|----------|-------|
| 41876-30 | 30,5  |
| 41876-38 | 38,0  |
| 41876-45 | 45,0  |
| 41876-58 | 58,0  |



**Mirror, cube**  
Specchio cubo  
Spiegel, Würfel  
Miroir cube  
Espejo cubo

| art.     | dim. cm. |
|----------|----------|
| 41882-15 | 15x15x15 |
| 41882-20 | 20x20x20 |
| 41882-25 | 25x25x25 |
| 41882-30 | 30x30x30 |



**W**  
**FE**

**Set 2 lanterns**  
Set 2 lanterne  
Set 2 laternen  
Set 2 lanternes  
Set 2 linternas

| art.     | dim. cm.             |
|----------|----------------------|
| 42440-30 | 22x20x52<br>30x26x71 |



**W**  
**FE**

**Set 2 lanterns**  
Set 2 lanterne  
Set 2 laternen  
Set 2 lanternes  
Set 2 linternas

| art.     | dim. cm.             |
|----------|----------------------|
| 42441-25 | 17x17x44<br>25x25x62 |



**W**  
**FE**

**Set 2 lanterns**  
Set 2 lanterne  
Set 2 laternen  
Set 2 lanternes  
Set 2 linternas

| art.     | dim. cm.             |
|----------|----------------------|
| 42442-24 | 17x17x45<br>24x24x67 |



**Set 3 candele**

Set 3 candles  
Kunstkerzen, 3er Set  
Set 3 bougies  
Set 3 velas

| art.     | Ø cm. | h. cm. |
|----------|-------|--------|
| 42445-03 | 9     | 12,5   |
|          | 9     | 18     |
|          | 9     | 23     |

**Resin. Timer function 5 hours ON/19 OFF. Powered by 2D alkaline batteries (not incl.). Working time >800 hours. Flameless moving wick. – Resina. Funzione timer 5 ore ON/19 OFF. 2 batterie alcaline D (non incluse). Durata > 800 ore. Stoppino mobile senza fiamma.**



**Tray stand, chromed**

Stand per vassoi, cromato  
Tablett-Träger, verchromt  
Porte plateaux, chromé  
Soporte para bandejas, cromado

| art.     | dim. cm.  |
|----------|-----------|
| 44093-00 | 38x 48x74 |



**Tray stand**

Stand per vassoi  
Tablett-Träger  
Porte plateaux  
Soporte para bandejas

| art.     | dim. cm. |
|----------|----------|
| 44093-01 | 42x43x82 |



**Tray**

Vassoio  
Tablett  
Plateau  
Bandeja

| art.     | dim. cm.  | GN  |
|----------|-----------|-----|
| 41430-11 | 53x32,5x5 | 1/1 |

**Chrome plated handles. Useful height 4 cm. Maniglie cromate. Altezza utile 4 cm.**



**Tray**

Vassoio  
Tablett  
Plateau  
Bandeja

| art.     | dim. cm.  | GN  |
|----------|-----------|-----|
| 41436-11 | 53x32,5   | 1/1 |
| 41436-12 | 32,5x26,5 | 1/2 |



**Tray, deko-edge**

Vassoio bordo Deko  
Tablett, Dekorrand  
Plateau avec décor  
Bandeja, borde decorado

| art.     | dim. cm.  | GN  |
|----------|-----------|-----|
| 41437-11 | 53x32,5   | 1/1 |
| 41437-12 | 32,5x26,5 | 1/2 |



**Tray, deko-edge**

Vassoio bordo Deko  
Tablett, Dekorrand  
Plateau avec décor  
Bandeja, borde decorado

| art.     | Ø mm. |
|----------|-------|
| 41439-32 | 32    |
| 41439-38 | 38    |
| 41439-48 | 48    |





SS

**Tray, deko-edge**

Vassoio bordo Deko  
Tablett, Dekorrand  
Plateau avec décor  
Bandeja, borde decorado

| art.     | dim. cm. |
|----------|----------|
| 41438-50 | 50x36    |
| 41438-60 | 60x41    |
| 41438-70 | 70x46    |



SS

**Fish tray**

Vassoio pesce  
Fischplatte  
Plat à poisson  
Salmonera

| art.     | dim. cm. |
|----------|----------|
| 66345-55 | 55x23    |
| 66345-65 | 65x27    |
| 66345-74 | 74x29    |



SS

**Fish tray**

Vassoio pesce  
Fischplatte  
Plat à poisson  
Salmonera

| art.     | dim. cm. |
|----------|----------|
| 41654-80 | 80x31    |
| 41654-99 | 100x35   |



SS

**Tray, oval**

Vassoio ovale  
Tablett, oval  
Plateau ovale  
Bandeja oval

| art.     | dim. cm. |
|----------|----------|
| 41651-20 | 20x14    |
| 41651-25 | 25x18    |
| 41651-30 | 30x22    |
| 41651-35 | 35x22    |
| 41651-40 | 40x26    |



SS

**Tray, oval**

Vassoio ovale  
Tablett, oval  
Plateau ovale  
Bandeja oval

| art.     | dim. cm. |
|----------|----------|
| 41651-45 | 45x29    |
| 41651-50 | 50x35    |
| 41651-55 | 55x38    |
| 41651-60 | 60x42    |
| 41651-65 | 65x45    |



SS

**Tray, round**

Vassoio tondo  
Tablett, rund  
Plateau rond  
Bandeja redonda

| art.     | Ø cm. |
|----------|-------|
| 66326-30 | 30    |
| 66326-35 | 35    |
| 66326-40 | 40    |
| 66326-60 | 60    |
| 66326-80 | 80    |



SS

**Tray, oval**

Vassoio ovale  
Tablett, oval  
Plateau ovale  
Bandeja oval

| art.     | dim. cm. |
|----------|----------|
| 66325-30 | 30x19    |
| 66325-35 | 35x22    |
| 66325-41 | 41x26    |
| 66325-46 | 46x29    |
| 66325-54 | 54x37    |
| 66325-85 | 85x58    |
| 66325-99 | 100x68   |



SS

**Tray, rectangular**

Vassoio rettangolare  
Serviertablett, rechteckig  
Plateau rectangulaire  
Bandeja rectangular

| art.     | dim. cm. |
|----------|----------|
| 66320-28 | 28x20    |
| 66320-35 | 35x30    |
| 66320-40 | 40x26    |
| 66320-50 | 50x38    |
| 66320-65 | 65x50    |
| 66320-85 | 85x50    |
| 66320-99 | 100x50   |



SS

**Tray, rectangular**

Vassoio rettangolare  
Serviertablett, rechteckig  
Plateau rectangulaire  
Bandeja rectangular

| art.     | dim. cm. |
|----------|----------|
| 66324-40 | 40x26    |
| 66324-50 | 50x38    |
| 66324-65 | 65x50    |
| 66324-85 | 85x50    |
| 66324-99 | 100x50   |

BUFFET SYSTEM



**ACACIA WOOD** for a multifunctional buffet system that adapts in height and width to all space requirements. The stackable and non-slip reversible boxes can be used individually or connected with flat GN trays.

**LEGNO DI ACACIA** per un sistema multifunzionale che si adatta in altezza e larghezza a tutte le esigenze di spazio. Le scatole reversibili, impilabili e antiscivolo possono essere utilizzate singolarmente o collegate con i piani GN.



**Box**  
Scatola  
Wendebox  
Boîte  
Caja

| art.     | dim. cm.     | GN  |
|----------|--------------|-----|
| 42463A02 | 55,5x35x10,5 | 1/1 |



**Box**  
Scatola  
Wendebox  
Boîte  
Caja

| art.     | dim. cm.       | GN  |
|----------|----------------|-----|
| 42463A04 | 55,5x18,5x10,5 | 2/4 |



**Box**  
Scatola  
Wendebox  
Boîte  
Caja

| art.     | dim. cm.   | GN  |
|----------|------------|-----|
| 42463A05 | 35x29x10,5 | 1/2 |



**Box**  
Scatola  
Wendebox  
Boîte  
Caja

| art.     | dim. cm.     | GN  |
|----------|--------------|-----|
| 42463A08 | 29x18,5x10,5 | 1/4 |



**Box**  
Scatola  
Wendebox  
Boîte  
Caja

| art.     | dim. cm.     | GN  |
|----------|--------------|-----|
| 42463B02 | 55,5x35x10,5 | 1/1 |



**Box**  
Scatola  
Wendebox  
Boîte  
Caja

| art.     | dim. cm.       | GN  |
|----------|----------------|-----|
| 42463B04 | 55,5x18,5x10,5 | 2/4 |





**Box**  
Scatola  
Wendebox  
Boîte  
Caja

| art.     | dim. cm.   | GN  |
|----------|------------|-----|
| 42463B05 | 35x29x10,5 | 1/2 |



**Box**  
Scatola  
Wendebox  
Boîte  
Caja

| art.     | dim. cm.     | GN  |
|----------|--------------|-----|
| 42463B08 | 29x18,5x10,5 | 1/4 |



**Bread box**  
Cesta pane  
Brotkiste  
Caisse à pain  
Cajón para pan

| art.     | dim. cm.   |
|----------|------------|
| 42874-01 | 34x26x12,5 |
| 42874-02 | 34x26x20   |

**Beech wood. – Faggio.**



**Bread cutting board**  
Tagliere  
Brottschneidbrett  
Planche à découper  
Tabla de corte

| art.     | dim. cm. |
|----------|----------|
| 42874-03 | 52x34x2  |

**Beech wood. – Faggio.**



**Cutting board tray**  
Vassoio per tagliere  
Schneidbrett-Tablett  
Plateau pour planche à découper  
Bandeja para tabla de corte

| art.     | dim. cm.    |
|----------|-------------|
| 42874-04 | 60x35,5x3,5 |



**Pretzel stand**  
Porta Brezel  
Brezel- oder Wurstständer  
Support à brezel  
Soporte para brezel

| art.     | Ø cm. | h. cm. |
|----------|-------|--------|
| 42870-50 | 22    | 50     |

**Beechwood. – Faggio.**



**Hygienic cover**  
Copertura igienica  
Hygieneschutz  
Couverture d'hygiène  
Cobertura d'higiene

| art.     | dim. cm. |
|----------|----------|
| 42870-51 | 20x20x50 |





AY  
SS

**Bread roll dispenser**  
Distributore panini  
Brötchen-Spender  
Distributeur à pain  
Dispensador de pan

art. dim. cm.  
42963-55 32x22x55

For/Per: 65-70 pcs.



W

**Bread slicer**  
Taglia pane  
Brottschneidergerät  
Coupe-pain  
Corta-pan

art. dim. cm.  
49833-00 41x15x10



AY

**Hygienic cover**  
Copertura igienica  
Hygieneschutz  
Couverture d'hygiène  
Cobertura d'higiene

art. dim. cm.  
42873-65 65x39x42

Chrome plated wire stand. – Supporto cromato.



PP

**Bread basket**

Cesto pane  
Brotkorb  
Corbeille à pain  
Cesta pan

| art.     | dim. cm.      | GN  | col. |
|----------|---------------|-----|------|
| 42462-11 | 53x32,5x6,5   | 1/1 | ●    |
| 42462-12 | 32,5x26,5x6,5 | 1/2 | ●    |
| 42462-13 | 32,5x17,5x6,5 | 1/3 | ●    |
| 42462-14 | 26,4x16,2x6,5 | 1/4 | ●    |
| 42462-16 | 17,6x16,2x6,5 | 1/6 | ●    |
| 42462-23 | 32,5x35,4x6,5 | 2/3 | ●    |



PP

**Bread basket**

Cesto pane  
Brotkorb  
Corbeille à pain  
Cesta pan

| art.     | dim. cm.     | GN  | col. |
|----------|--------------|-----|------|
| 42463-11 | 53x32,5x10   | 1/1 | ●    |
| 42463-12 | 32,5x26,5x10 | 1/2 | ●    |
| 42463-13 | 32,5x17,5x10 | 1/3 | ●    |
| 42463-14 | 26,4x16,2x10 | 1/4 | ●    |
| 42463-16 | 17,6x16,2x10 | 1/6 | ●    |
| 42463-23 | 32,5x35,4x10 | 2/3 | ●    |



PP

**Bread basket**

Cesto pane  
Brotkorb  
Corbeille à pain  
Cesta pan

| art.     | dim. cm.      | GN  | col. |
|----------|---------------|-----|------|
| 42967-63 | 53x32,5x6,5   | 1/1 | ●    |
| 42967-64 | 32,5x26,5x6,5 | 1/2 | ●    |
| 42967-65 | 32,5x17,5x6,5 | 1/3 | ●    |
| 42967-66 | 26,4x16,2x6,5 | 1/4 | ●    |
| 42967-67 | 17,6x16,2x6,5 | 1/6 | ●    |
| 42967-68 | 32,5x35,4x6,5 | 2/3 | ●    |



PP

**Bread basket**

Cesto pane  
Brotkorb  
Corbeille à pain  
Cesta pan

| art.     | dim. cm.     | GN  | col. |
|----------|--------------|-----|------|
| 42967-73 | 53x32,5x10   | 1/1 | ●    |
| 42967-74 | 32,5x26,5x10 | 1/2 | ●    |
| 42967-75 | 32,5x17,5x10 | 1/3 | ●    |
| 42967-76 | 26,4x16,2x10 | 1/4 | ●    |
| 42967-77 | 17,6x16,2x10 | 1/6 | ●    |
| 42967-78 | 32,5x35,4x10 | 2/3 | ●    |



**BUFFET**



**Bread basket**

Cesto pane  
Brotkorb  
Corbeille à pain  
Cesta pan

| art.     | dim. cm.      | GN  | col. |
|----------|---------------|-----|------|
| 42967-03 | 53x32,5x6,5   | 1/1 | ●    |
| 42967-04 | 32,5x26,5x6,5 | 1/2 | ●    |
| 42967-05 | 32,5x17,5x6,5 | 1/3 | ●    |
| 42967-06 | 26,4x16,2x6,5 | 1/4 | ●    |
| 42967-07 | 17,6x16,2x6,5 | 1/6 | ●    |
| 42967-08 | 32,5x35,4x6,5 | 2/3 | ●    |



**Bread basket**

Cesto pane  
Brotkorb  
Corbeille à pain  
Cesta pan

| art.     | dim. cm.     | GN  | col. |
|----------|--------------|-----|------|
| 42967-13 | 53x32,5x10   | 1/1 | ●    |
| 42967-14 | 32,5x26,5x10 | 1/2 | ●    |
| 42967-15 | 32,5x17,5x10 | 1/3 | ●    |
| 42967-16 | 26,4x16,2x10 | 1/4 | ●    |
| 42967-17 | 17,6x16,2x10 | 1/6 | ●    |
| 42967-18 | 32,5x35,4x10 | 2/3 | ●    |



**Bread basket**

Cesto pane  
Brot-Korb  
Corbeille à pain  
Cesta pan

| art.     | dim. cm. | l. cm. |
|----------|----------|--------|
| 42973-30 | 30x40    | 16/27  |



**Bread basket**

Cesto pane  
Brot-Korb  
Corbeille à pain  
Cesta pan

| art.     | dim. cm. | l. cm. |
|----------|----------|--------|
| 42973-45 | 45x40    | 16/27  |
| 42973-61 |          |        |



**Bread basket**

Cesto pane  
Brot-Korb  
Corbeille à pain  
Cesta pan

| art.     | dim. cm. | l. cm. |
|----------|----------|--------|
| 42973-60 | 60x40    | 16/27  |



**Bread basket**

Cesta baguettes  
Brotkorb  
Corbeille à pain  
Cesta pan

| art.     | cap. kg. | l. cm. |
|----------|----------|--------|
| 42967-35 | 35       | 25/42  |



**Bread basket**

Cesta baguettes  
Brotkorb  
Corbeille à pain  
Cesta pan

| art.     | cap. kg. | l. cm. |
|----------|----------|--------|
| 42972-28 | 30       | 38     |



**Bread basket**

Cesto pane  
Brotkorb  
Corbeille à pain  
Cesta pan

| art.     | cap. kg. | l. cm. |
|----------|----------|--------|
| 42968-38 | 38       | 10     |



**Bread basket**

Cesto pane  
Brotkorb  
Corbeille à pain  
Cesta pan

| art.     | cap. kg. | l. cm. |
|----------|----------|--------|
| 42968-42 | 42       | 12     |



**Bread basket**

Cesto pane  
Brotkorb  
Corbeille à pain  
Cesta pan

| art.     | cap. kg. | l. cm. |
|----------|----------|--------|
| 42969-31 | 31/37    | 6/12   |



**Bread basket**

Cesto pane  
Brotkorb  
Corbeille à pain  
Cesta pan

| art.     | cap. kg. | l. cm. |
|----------|----------|--------|
| 42969-36 | 36,5     | 12     |



**Bread basket**

Cesto pane  
Brotkorb  
Corbeille à pain  
Cesta pan

| art.     | dim. cm. | h. cm. |
|----------|----------|--------|
| 42967-43 | 45x42    | 17/24  |



**Bread basket**

Cesto pane  
Brotkorb  
Corbeille à pain  
Cesta pan

| art.     | dim. cm. |
|----------|----------|
| 42972-01 | 40x20x5  |
| 42972-02 | 40x30x5  |
| 42972-03 | 60x20x5  |
| 42972-04 | 60x40x5  |



**Bread basket**

Cesto pane  
Brotkorb  
Corbeille à pain  
Cesta pan

| art.     | dim. cm.     |
|----------|--------------|
| 42967-53 | 53x32,5x15,5 |



**Bread basket**

Cesto pane  
Brotkorb  
Corbeille à pain  
Cesta pan

| art.     | dim. cm. |
|----------|----------|
| 42936-23 | 23x19x9  |



**Bread basket**

Cesto pane  
Brotkorb  
Corbeille à pain  
Cesta pan

| art.     | dim. cm.  |
|----------|-----------|
| 42936-24 | 24x17x8   |
| 42936-28 | 28x16x8,5 |



**Bread basket**

Cesto pane  
Brotkorb  
Corbeille à pain  
Cesta pan

| art.     | dim. cm.  |
|----------|-----------|
| 42946-23 | 23x10x6   |
| 42946-37 | 37,5x15x7 |



**Bread basket**

Cesto pane  
Brotkorb  
Corbeille à pain  
Cesta pan

| art.     | dim. cm. |
|----------|----------|
| 42947-23 | 23x15x7  |
| 42947-30 | 30x22x7  |
| 42947-40 | 41x29x7  |



**Bread basket**

Cesto pane  
Brotkorb  
Corbeille à pain  
Cesta pan

| art.     | dim. cm.      | GN  |
|----------|---------------|-----|
| 42969-11 | 53,5x32,5x9,5 | 1/1 |



**Bread basket**

Cesto pane  
Brotkorb  
Corbeille à pain  
Cesta pan

| art.     | dim. cm.    | GN  |
|----------|-------------|-----|
| 42965-12 | 32,5x26,5x8 | 1/2 |





**Bread basket**

Cesto pane  
Brotkorb  
Corbeille à pain  
Cesta pan

art. dim. cm. GN  
42967-11 56,5x36x10 1/1

**With frame to fix the cover.**  
Con telaio per fissare il coperchio.



**Roll-top cover**

Coperchio roll-top  
Rolltophaube  
Couvercle roll-top  
Tapa roll-top

art. dim. cm. GN  
41415-11 53x32,5x17 1/1

**Chrome knob. – Pomolo cromato.**



**Bread basket**

Cesto pane  
Brotkorb  
Corbeille à pain  
Cesta pan

art. dim. cm. GN  
42461-11 56,5x36x10 1/1

**With frame to fix the cover.**  
Con telaio per fissare il coperchio.



**Roll-top cover**

Coperchio roll-top  
Rolltophaube  
Couvercle roll-top  
Tapa roll-top

art. dim. cm. GN  
42452-53 53x32,5x17 1/1

**Chrome knob. – Pomolo cromato.**



**Bread basket**

Cesto pane  
Brotkorb  
Corbeille à pain  
Cesta pan

art. cap. kg. l. cm.  
42461-35 35 20

**With frame to fix the cover.**  
Con telaio per fissare il coperchio.



**Roll-top cover**

Coperchio roll-top  
Rolltophaube  
Couvercle roll-top  
Campana roll-top

art. cap. kg.  
42452-35 35



**Cover**

Coperchio  
Kuppelhaube  
Couvercle  
Campana

art. dim. cm. GN  
41419-12 33x28x17 1/2

**One front cut. – Con apertura frontale.**



**Cover**

Coperchio  
Kuppelhaube  
Couvercle  
Campana

art. dim. cm. GN  
41418-11 54x33x20 1/1

**One front cut. – Con apertura frontale.**



**Cover**

Coperchio  
Kuppelhaube  
Couvercle  
Campana

art. dim. cm. GN  
41418-12 54x33x20 1/1

**Totally closed. – Chiuso.**



**Bread basket**

Cesto pane  
Brotkorb  
Corbeille à pain  
Cesta pan

art. dim. cm. col.  
42991-25 25x19X6,5 ●  
42991-32 32x23X7 ●



**Bread basket**

Cesto pane  
Brotkorb  
Corbeille à pain  
Cesta pan

art. dim. cm. col.  
42991M25 25x19X6,5 ●  
42991M32 32x23X7 ●



**Bread basket**

Cesto pane  
Brotkorb  
Corbeille à pain  
Cesta pan

art. dim. cm. col.  
42991N25 25x19X6,5 ●  
42991N32 32x23X7 ●



**Bread basket**

Cesto pane  
Brotkorb  
Corbeille à pain  
Cesta pan

| art.     | dim. cm. | col. |
|----------|----------|------|
| 42993-40 | 40X30X10 | ●    |
| 42993M40 | 40X30X10 | ●    |
| 42993N40 | 40X30X10 | ●    |



**Bread basket**

Cesto pane  
Brotkorb  
Corbeille à pain  
Cesta pan

| art.     | cap. kg. | l. cm. | col. |
|----------|----------|--------|------|
| 42990-16 | 16       | 8      | ●    |
| 42990-20 | 20       | 8      | ●    |
| 42990-29 | 29       | 7      | ●    |



**Bread basket**

Cesto pane  
Brotkorb  
Corbeille à pain  
Cesta pan

| art.     | cap. kg. | l. cm. | col. |
|----------|----------|--------|------|
| 42990M16 | 16       | 8      | ●    |
| 42990M20 | 20       | 8      | ●    |
| 42990M29 | 29       | 7      | ●    |



**Bread basket**

Cesto pane  
Brotkorb  
Corbeille à pain  
Cesta pan

| art.     | cap. kg. | l. cm. | col. |
|----------|----------|--------|------|
| 42990N16 | 16       | 8      | ●    |
| 42990N20 | 20       | 8      | ●    |
| 42990N29 | 29       | 7      | ●    |



**Bread basket stand**

Alzata ceste  
Körbe-Gestell  
Etagère à corbeilles  
Soporte ceste pan

| art.     | dim. cm.   |
|----------|------------|
| 42870-59 | 30,5x59x58 |

**For baskets 42968-38 and 42967-13.**  
Per cesti 42968-38 e 42967-13.



**Wire stand chrome plated, 2 tiers**

Supporto filo cromato, 2 piani  
Brotkorb-Drahtgestell, Doppeldecker  
Support en fil chromé, 2 étages  
Estructura alambre cromado, 2 alturas

| art.     | dim. cm. | GN  |
|----------|----------|-----|
| 42872-02 | 46x24x21 | 1/2 |

**For baskets/Per cesti:**  
**42965-12, 42967- 04-14-64-74.**

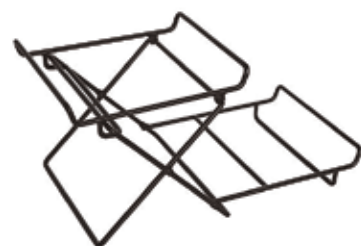

**Wire stand black, 2 tiers**

Supporto filo nero, 2 piani  
Brotkorb-Drahtgestell, Doppeldecker  
Support en fil noir, 2 étages  
Estructura alambre negro, 2 alturas

| art.     | dim. cm.   | GN  |
|----------|------------|-----|
| 41220-06 | 44,5x26x22 | 1/2 |



**Basket with black wire stand**

Cesto con supporto filo nero  
Korb drahtgestell, schwarz  
Panier support en fil noir  
Cesta estructura alambre negro

| art.     | dim. cm. |
|----------|----------|
| 41220-02 | 40x30    |
| 41220-03 | 60x40    |

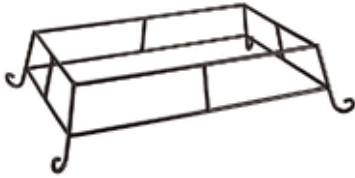

**NEW**

**Wire stand black**

Supporto filo nero  
Drahtgestell, schwarz  
Support en fil noir  
Estructura alambre negro

| art.     | dim. cm.     | GN  |
|----------|--------------|-----|
| 41220-07 | 49,5x30x13,5 | 1/1 |



**NEW**

**PP**

**Basket with black wire stand**

Cesto con supporto filo nero  
Korbdrahtgestell, schwarz  
Panier support en fil noir  
Cesta estructura alambre negro

| art.     | Ø cm. | h. cm. |
|----------|-------|--------|
| 41220-01 | 38    | 15,5   |



**NEW**

**PP**

**Basket with black wire stand**

Cesto con supporto filo nero  
Korbdrahtgestell, schwarz  
Panier support en fil noir  
Cesta estructura alambre negro

| art.     | Ø cm. | h. cm. |
|----------|-------|--------|
| 41220-04 | 33    | 15,5   |



**NEW**

**PP**

**Basket with black wire stand**

Cesto con supporto filo nero  
Korbdrahtgestell, schwarz  
Panier support en fil noir  
Cesta estructura alambre negro

| art.     | Ø cm. | h. cm. |
|----------|-------|--------|
| 41220-05 | 43    | 15,5   |



**Round canvas bag**

Cesto cotone, rotondo  
Brottasche, rund, Baumwolle  
Panier à pain, coton  
Cesta pan, algodón

| art.     | cap. kg. | l. cm. | col. |
|----------|----------|--------|------|
| 42873-02 | 20       | 23,5   | ●    |

**Stone pillow included. Easy to heat up in microwave for 90 sec. at 500 Watt. Machine washable up to 30°C (except pillow).** – Cuscino noccioli di ceramica incluso. Scaldare in microonde per 90 secondi a 500 Watt. Lavabile in lavatrice max 30°C (escluso cuscino).



**R**

**Egg basket, keeps warm**

Cesto uova, imbottito  
Eier-Korb, hält warm  
Panier à oeufs, fourré  
Cesta para huevos

| art.     | cap. kg. | l. cm. |
|----------|----------|--------|
| 42949-26 | 26       | 17     |

**For around 20 eggs. – Per c.ca 20 uova.**



**Sign holders, chromed**

Clip flessibili, cromate  
Schildhalter, verchromt  
Porte-étiquettes, chromés  
Porta etiquetas con clip, cromate

| art.     | l. cm. | pcs/pz |
|----------|--------|--------|
| 41394-02 | 12     | 2      |



**Chalkmarker**

Penna a gesso liquido  
Kreidestifte  
Stylo à craie liquide  
Rotulador de tiza líquida

| art.     | Ø mm. | col. |
|----------|-------|------|
| 47832-00 | 5     | ○    |
| 47832-01 | 5     | ●    |
| 47832-02 | 5     | ●    |
| 47832-03 | 5     | ●    |
| 47832-04 | 5     | ●    |
| 47832-05 | 5     | ●    |

**Clean with water. Writes on all non porous surfaces. – Pulire con acqua. Scrive su tutte le superfici non porose.**



**Chalkmarker**

Penna a gesso liquido

Kreidestifte

Stylo à craie liquide

Rotulador de tiza líquida

| art.     | Ø mm. | col. |
|----------|-------|------|
| 47832-10 | 15    | ○    |
| 47832-11 | 15    | ●    |
| 47832-12 | 15    | ●    |
| 47832-13 | 15    | ●    |
| 47832-14 | 15    | ●    |
| 47832-15 | 15    | ●    |



W  
SAN  
SS

**Showplate, 3-pcs set**

Vetrina, set 3 pezzi

Buffetvitrine, 3-teilig

Etagère, set 3 pièces

Vitrina, 3 elementos

| art.     | Ø cm. | h. cm. |
|----------|-------|--------|
| 41429-04 | 45    | 24     |



SAN

**Roll-top cover**

Coperchio roll-top

Rolltophaube

Couvercle roll-top

Campana roll-top

| art.     | Ø cm. | h. cm. |
|----------|-------|--------|
| 41447-38 | 38    | 20     |

Chrome knob. – Pomolo cromato.



SAN  
SS

**Showplate, 2-pcs set**

Vetrina, set 2 pezzi

Buffetvitrine, 2-teilig

Etagère, set 2 pièces

Vitrina, 2 elementos

| art.     | Ø cm. | h. cm. |
|----------|-------|--------|
| 41447-02 | 38    | 21     |



SN  
SAN  
SS

**Showplate, 5-pcs set**

Vetrina, set 5 pezzi

Buffetvitrine, 5-teilig

Etagère, set 5 pièces

Vitrina, 5 elementos

| art.     | Ø cm. | h. cm. |
|----------|-------|--------|
| 41447-05 | 38    | 24     |



SN  
W  
SAN  
SS

**Showplate, 3-pcs set**

Vetrina, set 3 pezzi

Buffetvitrine, 3-teilig

Etagère, set 3 pièces

Vitrina, 3 elementos

| art.     | Ø cm. | h. cm. |
|----------|-------|--------|
| 41905-38 | 43    | 4,5    |

Roll-top 41447-38 not included.  
Coperchio 41447-38 non incl.



SN  
AY  
SS

**Buffet showcase, 2 tiers**

Vetrina 2 piani

Büffet-Vitrine, Doppeldecker

Vitrine 2 étages

Vitrina doble

| art.     | Ø cm. | h. cm. |
|----------|-------|--------|
| 41905-03 | 43,5  | 50     |

Roll-top 41447-38 not included.  
Coperchio 41447-38 non incl.



SN  
SAN  
SS

**Showplate, 3-pcs set**

Vetrina, set 3 pezzi

Buffetvitrine, 3-teilig

Etagère, set 3 pièces

Vitrina, 3 elementos

| art.     | Ø cm. | h. cm. | col. |
|----------|-------|--------|------|
| 41944-06 | 38    | 6      | ○    |
| 41944B06 | 38    | 6      | ●    |



**SAN**

**Roll-top cover**  
Coperchio roll-top  
Rolltophaube  
Couvercle roll-top  
Campana roll-top

| art.     | Ø cm. | h. cm. |
|----------|-------|--------|
| 41945-38 | 38    | 20     |



**AV**

**SS**

**Buffet showcase, 2 tiers**

Vetrina 2 piani  
Büffet-Vitrine, Doppeldecker  
Vitrine 2 étages  
Vitrina doble

| art.     | dim. cm. |
|----------|----------|
| 41428-03 | 61x38x52 |

**Roll-top lids 41415-11 not included.**  
Coperchi 41415-11 non incl.



**PC**

**Roll-top cover**

Coperchio roll-top  
Rolltophaube  
Couvercle roll-top  
Campana roll-top

| art.     | dim. cm.   | GN  |
|----------|------------|-----|
| 41415-10 | 53x32,5x17 | 1/1 |

**Gold plated knob. – Barretta dorata.**



**PC**

**Roll-top cover**  
Coperchio roll-top  
Rolltophaube  
Couvercle roll-top  
Campana roll-top

| art.     | dim. cm.   | GN  |
|----------|------------|-----|
| 41415-11 | 53x32,5x17 | 1/1 |

**Chrome knob. – Pomolo cromato.**



**SS**

**Showplate, 4-pcs set**

Vetrina, set 4 pezzi  
Buffetvitrine, 4-teilig  
Etagère, set 4 pièces  
Vitrina, 4 elementos

| art.     | dim. cm.    | GN  |
|----------|-------------|-----|
| 41907-56 | 56,5x36x8,5 | 1/1 |

**Box + tray GN 1/1 + 2 cooler, without rolltop cover 41415-11. – Base + vassoio + 2 eutettici, coperchio 41415-11 non incl.**



**W**

**Showplate, 4-pcs set**

Vetrina, set 4 pezzi  
Buffetvitrine, 4-teilig  
Etagère, set 4 pièces  
Vitrina, 4 elementos

| art.     | dim. cm. |
|----------|----------|
| 41906-60 | 60x41x5  |

**Box + tray GN 1/1 + 2 cooler, without rolltop cover 41415-11. – Base + vassoio + 2 eutettici, coperchio 41415-11 non incl.**



**W**

**PP**

**PS**

**Ice-box, 3 pcs set**  
Box portaghiaccio, set 3 pz  
Eisbox, 3-teilig  
Boîte à glaçons, 3 pièces  
Cubitera, 3 elementos

| art.     | dim. cm.     |
|----------|--------------|
| 41412-11 | 53x32,5x12,5 |

**Box wenge + plastic deep tray + drainer plate.**  
Base wengé + vasca plastica + griglia.



**SS**

**Showcase, 4-pcs set**

Vetrina, set 4 pezzi  
Buffetvitrine, 4-teilig  
Etagère, set 4 pièces  
Vitrina, 4 elementos

| art.     | dim. cm.    | col. |
|----------|-------------|------|
| 41940-06 | 43,5x32,5x6 | ○    |
| 41940B06 | 43,5x32,5x6 | ●    |

**Box, tray, 2 coolers.**  
Contenitore, vassoio, 2 eutettici.



**SAN**

**Roll-top cover**

Coperchio roll-top  
Rolltophaube  
Couvercle roll-top  
Campana roll-top

| art.     | dim. cm.   |
|----------|------------|
| 41941-44 | 44x33,5x17 |





**W**

**Cutting board**  
Tagliere  
Schneidebrett  
Planche à découper  
Tabla de corte

art. dim. cm.  
41941-43 43,5X32,5x2

**For showcases 419040-06, 41940B06.**  
Per vetrine 41940-06, 41940B06.

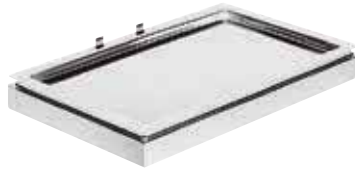

**SS**

**Cool plate**  
Vetrina refrigerata  
Büffet-Vitrine, kühlbar  
Vitrine réfrigérée  
Vitrina refrigerada

art. dim. cm. GN  
42450-00 53x32,5x8,5 1/1

**GN 1/1 base element, s/s platter, cooler.**  
Base GN 1/1, vassoio inox, eutettico.



**W**  
**SS**

**Cool plate**  
Vetrina refrigerata  
Büffet-Vitrine, kühlbar  
Vitrine réfrigérée  
Vitrina refrigerada

art. dim. cm. GN  
42460-00 53x32,5x8,5 1/1

**GN 1/1 base element, s/s platter, cooler.**  
Base GN 1/1, vassoio inox, eutettico.



**W**  
**SS**

**Cool plate**  
Vetrina refrigerata  
Büffet-Vitrine, kühlbar  
Vitrine réfrigérée  
Vitrina refrigerada

art. dim. cm. GN  
42470-00 53x32,5x8,5 1/1

**GN 1/1 base element, s/s platter, cooler.**  
Base GN 1/1, vassoio inox, eutettico.



**SS**

**Eutectic pad**  
Accumulatore di freddo  
Kühlakku  
Cartouche eutectique  
Placa eutética

art. dim. cm.  
42450-AD 41x21x2,5



**PC**

**GN roll-top cover**  
Coperchio GN roll-top  
GN-Rolltophaube  
Couvercle roll-top, GN  
Tapa roll-top, GN

art. GN  
42452-53 1/1



**GN**  
**SS**

**Tray**  
Vassoio  
Tablett  
Plateau  
Bandeja

art. GN  
42451-11 1/1  
42451-12 1/2



**W**

**Cutting board**  
Tagliere  
Tranchierbrett  
Planche à découper  
Plancha para cortar

art. GN  
42470-06 1/1



**W**

**Cutting board**  
Tagliere  
Tranchierbrett  
Planche à découper  
Plancha para cortar

art. GN  
42470-07 1/1



**PE**

**Cutting board**  
Tagliere  
Tranchierbrett  
Planche à découper  
Plancha para cortar

art. GN  
42460-06 1/1



**W**

**Cooled buffet showcase**  
Vetrina refrigerata  
Büffet-Vitrine, kühlbar  
Vitrine réfrigérée  
Vitrina refrigerada

art. dim. cm. col.  
42470-63 63,5x42,5x31 ●

**Woodbase with fixed roll-top cover, plastic case, GN 1/1 melamine tray, cooling unit.** – Base legno con coperchio roll-top fisso, vasca plastica, GN 1/1 in melamina, placca eutettica.



**W**

**Cooled buffet showcase**  
Vetrina refrigerata  
Büffet-Vitrine, kühlbar  
Vitrine réfrigérée  
Vitrina refrigerada

art. dim. cm. col.  
42460-63 63,5x42,5x31 ●

**Woodbase with fixed roll-top cover, plastic case, GN 1/1 melamine tray, cooling unit.** – Base legno con coperchio roll-top fisso, vasca plastica, GN 1/1 in melamina, placca eutettica.





PP  
W

**Cutlery dispenser**  
Portaposate  
Besteck-Behälter  
Bac à couverts  
Caja portacubiertos

| art.     | dim. cm.   | col. |
|----------|------------|------|
| 42470-64 | 57,5x47x12 | ●    |



PP  
W

**Cutlery dispenser**  
Portaposate  
Besteck-Behälter  
Bac à couverts  
Caja portacubiertos

| art.     | dim. cm.   | col. |
|----------|------------|------|
| 42460-64 | 57,5x47x12 | ●    |



MF

**Bowl**  
Ciotola  
Schüssel  
Bol

| art.     | Ø cm. | h. cm. | lt. | col. |
|----------|-------|--------|-----|------|
| 44837B05 | 14    | 6,5    | 0,5 | ●    |
| 44837B20 | 20    | 9,2    | 1,8 | ●    |
| 44837B25 | 23    | 10,0   | 2,5 | ●    |



MF

**Bowl**  
Ciotola  
Schüssel  
Bol

| art.     | Ø cm. | h. cm. | lt. | col. |
|----------|-------|--------|-----|------|
| 44837-05 | 14    | 6,5    | 0,5 | ○    |
| 44837-20 | 20    | 9,2    | 1,8 | ○    |
| 44837-25 | 23    | 10,0   | 2,5 | ○    |



**Bowl, glass**  
Ciotola, vetro  
Glasschüssel  
Bol en verre  
Bol vidrio

| art.     | Ø cm. | h. cm. | lt.  |
|----------|-------|--------|------|
| 41425-AA | 7,5   | 3,5    | 0,09 |
| 41405-AA | 14,0  | 6,5    | 0,5  |
| 41400-AA | 23,0  | 10,0   | 2,5  |



PC

**Airtight cover**  
Coperchio ermetico  
Frischhaltedeckel  
Couvercle hermétique  
Tapa hermética

| art.     | Ø cm. |
|----------|-------|
| 42452-14 | 14    |
| 42452-23 | 23    |



PC

**Cover**  
Coperchio  
Deckel  
Couvercle  
Tapa

| art.     | Ø cm. |
|----------|-------|
| 42453-23 | 23    |



SAN

**Cover**  
Coperchio  
Deckel  
Couvercle  
Tapa

| art.     | Ø cm. |
|----------|-------|
| 44837C20 | 20,5  |

Matches/Per: 44837-20 & 44837B20.



**Bowl holder, chromed**  
Portaciotole, cromato  
Schalenhalter, Metall hartverchromt  
Étagère à bols, chromée  
Soporte para bols, cromado

| art.     | Ø cm. | h. cm. |
|----------|-------|--------|
| 41427-40 | 18    | 25,5   |

For 36 bowls ø cm 7 # 41425-AA.  
Per 36 ciotoline ø cm 7 # 41425-AA.



W

**Cool bowl**

Ciotola refrigerata  
Kühlschale  
Bol réfrigérée  
Bol refrigerda

| art.     | dim. cm.     | lt. | col. |
|----------|--------------|-----|------|
| 42470-26 | 18,5x18,5x10 | 0,5 | ●    |
| 42470-27 | 27,5x27,5x14 | 2,5 | ●    |

**Wood base, s/s container, melamine bowl, cooling unit.** – Base legno, contenitore inox, ciotola melamina, placca eutettica.



W

**Cool bowl**

Ciotola refrigerata  
Kühlschale  
Bol réfrigérée  
Bol refrigerda

| art.     | dim. cm.     | lt. | col. |
|----------|--------------|-----|------|
| 42460-26 | 18,5x18,5x10 | 0,5 | ●    |
| 42460-27 | 27,5x27,5x14 | 2,5 | ●    |

**Wood base, s/s container, melamine bowl, cooling unit.** – Base legno, contenitore inox, ciotola melamina, placca eutettica.



AY

PC

SS

**Cool bowl**

Ciotola refrigerata  
Kühlschale  
Bol réfrigérée  
Bol refrigerda

| art.     | Ø cm. | h. cm. | lt. |
|----------|-------|--------|-----|
| 41448-06 | 14    | 9,0    | 0,6 |
| 41448-10 | 14    | 11,5   | 1,0 |

**Base + cooler + bowl + cover.**  
Base + eutettico + ciotola + coperchio.



AY

PC

SS

**Cool bowl**

Ciotola refrigerata  
Kühlschale  
Bol réfrigérée  
Bol refrigerda

| art.     | Ø cm. | h. cm. | lt. |
|----------|-------|--------|-----|
| 41448-25 | 22    | 14     | 2,5 |
| 41448-40 | 22    | 18     | 4,0 |

**Base + cooler + bowl + cover.**  
Base + eutettico + ciotola + coperchio.



**Buffet stand, chrome plated**

Alzata, cromata  
Buffet-Gestell, Metall hartverchromt  
Présentoir, chromé  
Soporte, cromado

| art.     | dim. cm. |
|----------|----------|
| 41442-03 | 61x24x35 |

**3 glass bowls ø cm 23 + 3 covers.**  
3 ciotole ø cm 23 + covers.

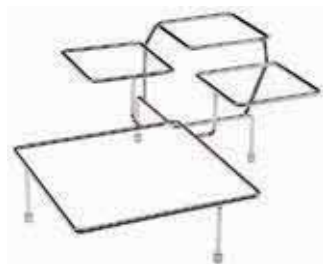

**Serving stand, chrome plated**

Supporto cromato  
Serviergestell, hartverchromt  
Présentoir, acier chromé  
Soporte platos, acero cromado

| art.     | dim. cm. |
|----------|----------|
| 44840-06 | 39x39x17 |

**For bowls/Per ciotole: 12,5x12,5 e 25x25 cm.**



**Serving stand, chrome plated**

Supporto cromato  
Serviergestell, hartverchromt  
Présentoir, acier chromé  
Soporte platos, acero cromado

| art.     | dim. cm.     |
|----------|--------------|
| 44840-07 | 55,5x19x15,5 |

**For bowls 19x19 cm. NOT included.**  
Per ciotole 19x19 cm. NON include.





MF

**Bowl**

Ciotola  
Schüssel  
Bol  
Bol

| art.     | dim. cm.    |
|----------|-------------|
| 44884-12 | 12,5x12,5x6 |
| 44884-19 | 19x19x9,5   |
| 44884-25 | 25x25x12    |



MF

**Bowl**

Ciotola  
Schüssel  
Bol  
Bol

| art.     | dim. cm.    |
|----------|-------------|
| 44884B12 | 12,5x12,5x6 |
| 44884B19 | 19x19x9,5   |
| 44884B25 | 25x25x12    |



SAN

**Cover**

Coperchio  
Deckel  
Couvrecl  
Tapa

| art.     | dim. cm. |
|----------|----------|
| 44885-19 | 19x19    |
| 44885-25 | 25x25    |



**Buffet stand, chrome plated**

Alzata, cromata  
Buffet-Gestell, Metall hartverchromt  
Présentoir, chromé  
Soporte, cromado

| art.     | dim. cm. |
|----------|----------|
| 41442-14 | 30x30x14 |

**3 glass bowls ø cm 14 + 3 covers.**  
3 ciotole ø cm 14 + covers.



**Buffet stand, chrome plated**

Alzata, cromata  
Buffet-Gestell, Metall hartverchromt  
Présentoir, chromé  
Soporte, cromado

| art.     | dim. cm. |
|----------|----------|
| 41442-23 | 50x50x18 |

**3 glass bowls ø cm 23 + 3 covers.**  
3 ciotole ø cm 23 + covers.



**Bowl holder, chromed**

Portaciotole, cromato  
Schalenhalter, Metall hartverchromt  
Étagère à bols, chromée  
Soporte para bols, cromado

| art.     | Ø cm. | h. cm. |
|----------|-------|--------|
| 41427-40 | 18    | 25,5   |

**For 36 bowls ø cm 7 # 41425-AA.**  
Per 36 ciotoline ø cm 7 # 41425-AA.



**Serving stand, chrome plated**

Alzata, cromata  
Serviergestell, Metall hartverchromt  
Présentoir, chromé  
Soporte platos para buffet, cromado

| art.     | Ø cm. | h. cm. |
|----------|-------|--------|
| 42962-04 | 34    | 37     |

**For 4 plates max. Ø 31 cm, inside Ø 23,5 cm.**



**Serving stand, chrome plated**

Alzata, cromata  
Serviergestell, Metall hartverchromt  
Présentoir, chromé  
Soporte platos, cromado

| art.     | dim. cm.     | col. |
|----------|--------------|------|
| 42962C26 | 18,5x15,5x26 | ●    |
| 42962C44 | 29x19,5x43   | ●    |

**26: for 3 plates max. Ø 17 cm, inside Ø 10,5 cm**  
**44: for 3 plates max. Ø 27 cm, inside Ø 18 cm**



**Serving stand**

Alzata  
Serviergestell  
Présentoir  
Soporte platos

| art.     | dim. cm.     |
|----------|--------------|
| 42962-26 | 18,5x15,5x26 |
| 42962-30 | 29x19,5x30   |
| 42962-44 | 29x19,5x43   |

**26: for 3 plates max. Ø 17 cm, inside Ø 10,5 cm**  
**30: for 2 plates max. Ø 27 cm, inside Ø 18 cm**  
**44: for 3 plates max. Ø 27 cm, inside Ø 18 cm**



**FE**  
**SS**

**Fruit stand**  
Espositore porta frutta  
Obstspender  
Etagère à fruits  
Expositor frutas

| art.     | cap. kg. | h. cm. |
|----------|----------|--------|
| 41449-27 | 27,5     | 32     |



**FE**  
**SS**

**Fruit stand**  
Espositore porta frutta  
Obstspender  
Etagère à fruits  
Expositor frutas

| art.     | cap. kg. | h. cm. |
|----------|----------|--------|
| 41449-32 | 32       | 53     |



**SS**

**Fruit stand**  
Alzata Royale  
Obstständer  
Etagère Royale  
Expositor de frutas

| art.     | Ø cm.    | h. cm. |
|----------|----------|--------|
| 41820-03 | 24-33-42 | 50     |



**Buffet ladder, chrome plated**  
Espositore buffet, cromato  
Büffet-Leiter, verchromt  
Escalier à buffet, chromé  
Escalera para buffet, cromada

| art.     | dim. cm. |
|----------|----------|
| 41912-03 | 30x30x48 |

**With 4 bowls ø cm 14 + lids.**  
Con 4 ciotole ø cm 14 + coperchi.



**Buffet ladder, chrome plated**  
Espositore buffet, cromato  
Büffet-Leiter, verchromt  
Escalier à buffet, chromé  
Escalera para buffet, cromada

| art.     | dim. cm. |
|----------|----------|
| 41912-04 | 30x30x48 |

**With 6 bowls ø cm 14. – Con 6 ciotole ø cm 14.**



**Buffet ladder, chrome plated**  
Espositore buffet, cromato  
Büffet-Leiter, verchromt  
Escalier à buffet, chromé  
Escalera para buffet, cromada

| art.     | dim. cm. |
|----------|----------|
| 41913-03 | 39x31x66 |

**With 4 bowls ø cm 23 + lids.**  
Con 4 ciotole ø cm 23 + coperchi.



**Buffet ladder, chrome plated**  
Espositore buffet, cromato  
Büffet-Leiter, verchromt  
Escalier à buffet, chromé  
Escalera para buffet, cromada

| art.     | dim. cm. |
|----------|----------|
| 41913-04 | 39x31x66 |

**With 6 bowls ø cm 23. – Con 6 ciotole ø cm 23.**



**GN**

**Buffet ladder, chrome plated**  
Espositore buffet, cromato  
Büffet-Leiter, verchromt  
Escalier à buffet, chromé  
Escalera para buffet, cromada

| art.     | dim. cm.   | GN  |
|----------|------------|-----|
| 41403-01 | 31,5x32x48 | 1/3 |

**For GN pans see page 73.**  
Per contenitori GN vedi pag. 73.





**Buffet ladder, chrome plated**  
Espositore buffet, cromato  
Büffet-Leiter, verchromt  
Escalier à buffet, chromé  
Escalera para buffet, cromada

art. dim. cm. GN  
41403-02 31,5x41,5x48 1/2

**For baskets see pages 415-416.**  
Per cesti vedi pagg. 415-416.



**Buffet ladder, chrome plated**  
Espositore buffet, cromato  
Büffet-Leiter, verchromt  
Escalier à buffet, chromé  
Escalera para buffet, cromada

art. dim. cm. GN  
41403-03 31,5x56x66 1/2



**Buffet ladder, chrome plated**  
Espositore buffet, cromato  
Büffet-Leiter, verchromt  
Escalier à buffet, chromé  
Escalera para buffet, cromada

art. dim. cm. GN  
41403-04 52x59x66 1/1

**For GN pans see page 73.**  
Per contenitori GN vedi pag. 73.



**Multi rack**  
Multi-distributore  
Multi Rack  
Distributeur  
Dispensador

art. dim. cm.  
41908-01 26x18x43



**Multi rack**  
Multi-distributore  
Multi Rack  
Distributeur  
Dispensador

art. dim. cm.  
41908-00 26x18x43



**Multi rack**  
Multi-distributore  
Multi Rack  
Distributeur  
Dispensador

art. dim. cm.  
41911-02 19x24x28



**SAN**  
**SS**

**Multi rack**  
Multi-distributore  
Multi Rack  
Distributeur  
Dispensador

art. dim. cm.  
41911-03 19x24x41



**SAN**  
**SS**

**Multi rack**  
Multi-distributore  
Multi Rack  
Distributeur  
Dispensador

art. dim. cm.  
41911-04 19x24x53



**W**

**Buffet stand**  
Espositore buffet  
Buffetgestell  
Présentoir  
Expositor de buffet

art. dim. cm.  
42460-53 53x21x50

**Shelves/Ripiani: 30 x 15 - 40 x 17,5 - 53 x 19 cm.**



**W**

**Buffet stand**  
Espositore buffet  
Buffetgestell  
Présentoir  
Expositor de buffet

art. dim. cm.  
42470-53 53x21x50

**Shelves/Ripiani: 30 x 15 - 40 x 17,5 - 53 x 19 cm.**



**NEW**  
**W**  
**AR**

**2-Tier serving stand**  
Alzata 2 piani  
2-stufiger Servierstand  
Support 2 niveaux  
Soporte 2 pisos

art. dim. cm.  
41207-02 25x4,5x34,5

**Beech. Slate cm. 31x13 - 41x18.**  
Faggio. Ardesia cm. 31x13 - 41x18.



**NEW**  
**W**  
**AR**

**3-Tier serving stand**  
Alzata 3 piani  
3-stufiger Servierstand  
Support 3 niveaux  
Soporte 3 pisos

art. dim. cm.  
41207-03 25x4,5x54

**Beech. Slate cm. 21x8 - 31x13 - 41x18.**  
Faggio. Ardesia cm. 21x8 - 31x13 - 41x18..



**W**

**Stand**  
Alzata  
Ständer  
Support  
Soporte

art. dim. cm.  
42463A00 20x20x17,5

**Acacia wood.**



**W**

**Stand**  
Alzata  
Ständer  
Support  
Soporte

art. dim. cm.  
42463B00 20x20x17,5

**Acacia wood.**



**BUFFET**



W

**Stand**

Alzata  
Ständer  
Support  
Soporte

| art.     | Ø cm. | h. cm. |
|----------|-------|--------|
| 41445-01 | 15    | 10     |
| 41445-02 | 35    | 15     |

Acacia wood.



W

**Cereal-bar**

Espositore cereali  
Cerealien-Buffer-Ständer  
Présentoir à céréales  
Expositor de cereales

| art.     | dim. cm.   | col. |
|----------|------------|------|
| 42470-43 | 43x17x13,5 | ●    |

**3 glasses lt. 2 with airtight cover.**  
3 vasi lt. 2 con coperchio ermetico.



W

**Cereal-bar**

Espositore cereali  
Cerealienständer  
Présentoir à céréales  
Expositor de cereales

| art.     | dim. cm.   | col. |
|----------|------------|------|
| 42460-43 | 43x17x13,5 | ●    |

**3 glasses lt. 2 with airtight cover.**  
3 vasi lt. 2 con coperchio ermetico.



NEW

**Jam bar**

Espositore marmellate  
Konfitürenständer  
Présentoir à confitures  
Expositor de mermeladas

| art.     | dim. cm.   | ml.   |
|----------|------------|-------|
| 41206-05 | 34,5x9x8,5 | 3x176 |



NEW

AY

**Cereal-bar**

Espositore per cereali  
Cerealien-Bar  
Présentoir à céréales  
Expositor de cereales

| art.     | dim. cm.   | lt. |
|----------|------------|-----|
| 41806-03 | 39,5x12x26 | 3x1 |



NEW

AY

**Cereal pitcher**

Caraffa cereali  
Cerealienkaraffe  
Pichet à céréales  
Jarra de cereales

| art.     | Ø cm. | dim. cm. | lt. |
|----------|-------|----------|-----|
| 41806-00 | 9     | 25,5     | 1   |



SAN

SS

**Cereal dispenser**

Distributore di cereali  
Müslispender  
Distributeur à céréales  
Dispensador de cereales

| art.     | dim. cm.   | lt. |
|----------|------------|-----|
| 41810-04 | 22x17,5x52 | 4,5 |



SAN

SS

**Cereal dispenser**

Distributore di cereali  
Müslispender  
Distributeur à céréales  
Dispensador de cereales

| art.     | dim. cm. | lt.   |
|----------|----------|-------|
| 41810-09 | 22x35x52 | 2x4,5 |



PC

SS

**Cereal dispenser**

Distributore di cereali  
Müslispender  
Distributeur à céréales  
Dispensador de cereales

| art.     | dim. cm. | lt. |
|----------|----------|-----|
| 41909-08 | 33x24x64 | 7   |





**Cereal dispenser**  
Distributore di cereali  
Müslispender  
Distributeur à céréales  
Dispensador de cereales

| art.     | dim. cm.       | lt. |
|----------|----------------|-----|
| 41807-12 | 30,5x28,5x60,5 | 3x4 |



**Juice dispenser**  
Distributore di succhi  
Saftdispenser  
Distributeur à jus  
Dispensador zumos

| art.     | dim. cm. | lt. |
|----------|----------|-----|
| 41901-08 | 36x26x55 | 8   |



**Juice dispenser duo**  
Distributore di succhi duo  
Saftdispenser duo  
Distributeur à jus duo  
Dispensador de zumo, doble

| art.     | dim. cm. | lt. |
|----------|----------|-----|
| 41901-16 | 36x54x55 | 2x8 |



**Juice dispenser**  
Distributore di succhi  
Saftdispenser  
Distributeur à jus  
Dispensador zumos

| art.     | dim. cm. | lt. |
|----------|----------|-----|
| 18353-17 | 22x35x56 | 7   |

With one cooling pad. – Con 1 eutettico.



**Juice dispenser**  
Distributore di succhi  
Saftdispenser  
Distributeur à jus  
Dispensador zumos

| art.     | dim. cm. | lt. |
|----------|----------|-----|
| 41800-05 | 33x22x52 | 5   |



**Juice dispenser duo**  
Distributore di succhi duo  
Saftdispenser duo  
Distributeur à jus duo  
Dispensador de zumo, doble

| art.     | dim. cm.     | lt. |
|----------|--------------|-----|
| 41800-10 | 42,5x30,5x52 | 2x5 |



**Milk dispenser**  
Distributore di latte  
Milchkanne  
Distributeur à lait  
Dispensador de leche

| art.     | dim. cm. | lt. |
|----------|----------|-----|
| 41801-05 | 33x22x50 | 5   |



**Cereal dispenser**  
Distributore di cereali  
Cerealinspender  
Distributeur à céréales  
Dispensador de cereales

| art.     | dim. cm.   | lt. | col. |
|----------|------------|-----|------|
| 42470-45 | 21x20x55,5 | 4,5 | ●    |
| 42460-45 | 21x20x55,5 | 4,5 | ●    |

Maple/Wenge. – Acero/Wengè.



**Juice dispenser**  
Distributore di succhi  
Saftdispenser  
Distributeur à jus de fruit  
Dispensador de zumo

| art.     | dim. cm. | lt. |
|----------|----------|-----|
| 41808-04 | 16x24x35 | 4   |





**Juice dispenser**

Distributore di succhi  
Saftdispenser  
Distributeur à jus de fruit  
Dispensador de zumo

| art.     | dim. cm.   | lt. | col. |
|----------|------------|-----|------|
| 42470-74 | 31x20x42   | 4   | ●    |
| 42470-76 | 35,5x22x50 | 6   | ●    |

**Maple. With 2 cooling units. elements, top and base. – Acero. Con 2 eutettici, coperchio e base.**



**Juice dispenser**

Distributore di succhi  
Saftdispenser  
Distributeur à jus de fruit  
Dispensador de zumo

| art.     | dim. cm.   | lt. | col. |
|----------|------------|-----|------|
| 42460-74 | 31x20x42   | 4   | ●    |
| 42460-76 | 35,5x22x50 | 6   | ●    |

**Wenge. With 2 cooling units. elements, top and base. – Wengè. Con 2 eutettici, coperchio e base.**



**Juice dispenser**

Distributore di succhi  
Saftdispenser  
Distributeur à jus  
Dispensador zumos

| art.     | dim. cm. | lt. |
|----------|----------|-----|
| 41907-04 | 21x31x44 | 4   |
| 41907-06 | 23x35x52 | 6   |

**Beechwood. With cooling pads. Faggio. Con eutettici**



**Juice dispenser duo**

Distributore di succhi duo  
Saftdispenser duo  
Distributeur à jus duo  
Dispensador de zumo, doble

| art.     | dim. cm. | lt. |
|----------|----------|-----|
| 41907-02 | 42x35x52 | 2x6 |

**Beechwood. With cooling pads. Faggio. Con eutettici**



**Milk dispenser**

Distributore di latte  
Milchkanne  
Distributeur à lait  
Dispensador de leche

| art.     | dim. cm. | lt. |
|----------|----------|-----|
| 41920-03 | 21x32x39 | 3   |
| 41920-05 | 23x35x52 | 5   |

**Beechwood. With cooling pads. Faggio. Con eutettici**



**Milk dispenser**

Distributore di latte  
Milchkanne  
Distributeur à lait  
Dispensador de leche

| art.     | dim. cm.   | lt. |
|----------|------------|-----|
| 41900-04 | 23x32x42   | 4   |
| 41900-10 | 27x38,5x45 | 10  |

**Beechwood. With cooling pads. Faggio. Con eutettici**



**Insulated dispenser**

Distributore termico  
Iso-Dispenser  
Distributeur isothermique  
Dispensador térmico

| art.     | Ø cm. | h. cm.  | lt. |
|----------|-------|---------|-----|
| 41904-10 | 24    | 42>46,5 | 9,5 |



**Air pot**

Caraffa termica  
Thermopumpkanne  
Pot à air isothermique  
Jarra térmica

| art.     | lt. |
|----------|-----|
| 42406-35 | 3,5 |
| 42406-40 | 4,0 |



**Air pot**

Caraffa termica  
Thermopumpkanne  
Pot à air isothermique  
Jarra térmica

| art.     | lt. |
|----------|-----|
| 42400-19 | 1,9 |
| 42400-25 | 2,5 |
| 42400-30 | 3,0 |

# SERIES 12300

BUFFET LIVE COOKING

NEW     INDUCTION READY!



Paderno serie 12300 3-ply is especially designed for use in front of house and live cooking stations. Features super heat-conductive multi-layer construction that distributes heat from bottom to rim quickly and evenly. An attractive, multifunctional and colored line available in white, yellow, green, blue and orange. External finish with special heat-resistant paint (Whitford technology). Ideal for all types of cooking including induction. The lid equipped with a steam release device can be hooked to the side of the pan.

La serie Paderno 12300 3-ply è concepita per l'uso "front of house" e per le "live cooking stations". Costruita in materiale multistrato, assicura una distribuzione rapida ed uniforme del calore su tutta la superficie dell'utensile. Una linea attrattiva, multifunzionale e colorata disponibile nelle varianti bianco, giallo, verde, blu e arancio. Finitura esterna con speciale vernice (tecnologia Whitford) resistente al calore. Ideali per ogni tipo di cottura inclusa l'induzione. Il coperchio dotato di dispositivo di rilascio del vapore, può essere agganciato a lato della casseruola



**Stew pan with lid**

Casseruola con coperchio  
Brattpf mit Deckel  
Sautoir avec couvercle  
Sartén con tapa

| art.     | Ø cm. | h. cm. | lt. |
|----------|-------|--------|-----|
| 12303W16 | 16    | 8      | 1,6 |
| 12303W20 | 20    | 10     | 3,1 |
| 12303W24 | 24    | 12     | 5,4 |



**Stew pan with lid**

Casseruola con coperchio  
Brattpf mit Deckel  
Sautoir avec couvercle  
Sartén con tapa

| art.     | Ø cm. | h. cm. | lt. |
|----------|-------|--------|-----|
| 12303Y16 | 16    | 8      | 1,6 |
| 12303Y20 | 20    | 10     | 3,1 |
| 12303Y24 | 24    | 12     | 5,4 |



**Stew pan with lid**

Casseruola con coperchio  
Brattpf mit Deckel  
Sautoir avec couvercle  
Sartén con tapa

| art.     | Ø cm. | h. cm. | lt. |
|----------|-------|--------|-----|
| 12303G16 | 16    | 8      | 1,6 |
| 12303G20 | 20    | 10     | 3,1 |
| 12303G24 | 24    | 12     | 5,4 |



**Stew pan with lid**

Casseruola con coperchio  
Brattpf mit Deckel  
Sautoir avec couvercle  
Sartén con tapa

| art.     | Ø cm. | h. cm. | lt. |
|----------|-------|--------|-----|
| 12303B16 | 16    | 8      | 1,6 |
| 12303B20 | 20    | 10     | 3,1 |
| 12303B24 | 24    | 12     | 5,4 |



**Stew pan with lid**

Casseruola con coperchio  
Brattpf mit Deckel  
Sautoir avec couvercle  
Sartén con tapa

| art.     | Ø cm. | h. cm. | lt. |
|----------|-------|--------|-----|
| 12303O16 | 16    | 8      | 1,6 |
| 12303O20 | 20    | 10     | 3,1 |
| 12303O24 | 24    | 12     | 5,4 |



**Roasting pan with lid**

Casseruola carrè con coperchio  
Bräter mit Deckel  
Rôtissoire avec couvercle  
Asadera con tapa

| art.     | dim. cm. | h. cm. | lt. |
|----------|----------|--------|-----|
| 12304W26 | 27x27    | 7      | 4   |



**Roasting pan with lid**

Casseruola carrè con coperchio  
Bräter mit Deckel  
Rôtissoire avec couvercle  
Asadera con tapa

| art.     | dim. cm. | h. cm. | lt. |
|----------|----------|--------|-----|
| 12304Y26 | 27x27    | 7      | 4   |



**Roasting pan with lid**

Casseruola carrè con coperchio  
Bräter mit Deckel  
Rôtissoire avec couvercle  
Asadera con tapa

| art.     | dim. cm. | h. cm. | lt. |
|----------|----------|--------|-----|
| 12304G26 | 27x27    | 7      | 4   |



**Roasting pan with lid**

Casseruola carrè con coperchio  
Bräter mit Deckel  
Rôtissoire avec couvercle  
Asadera con tapa

| art.     | dim. cm. | h. cm. | lt. |
|----------|----------|--------|-----|
| 12304B26 | 27x27    | 7      | 4   |



**Roasting pan with lid**

Casseruola carrè con coperchio  
Bräter mit Deckel  
Rôtissoire avec couvercle  
Asadera con tapa

| art.     | dim. cm. | h. cm. | lt. |
|----------|----------|--------|-----|
| 12304O26 | 27x27    | 7      | 4   |



**Bowl double wall**

Ciotola doppia parete  
Schüssel, doppelwandig  
Bol à double paroi  
Tazón doble pared

| art.     | Ø cm. | h. cm. |
|----------|-------|--------|
| 12300-18 | 18    | 14,0   |
| 12300-24 | 24    | 18,2   |



**Bowl double wall**

Ciotola doppia parete  
Schüssel, doppelwandig  
Bol à double paroi  
Tazón doble pared

| art.     | Ø cm. | h. cm. |
|----------|-------|--------|
| 12300W18 | 18    | 14,0   |
| 12300W24 | 24    | 18,2   |



**Bowl double wall**  
Ciotola doppia parete  
Schüssel, doppelwandig  
Bol à double paroi  
Tazón doble pared

| art.     | Ø cm. | h. cm. |
|----------|-------|--------|
| 12300Y18 | 18    | 14,0   |
| 12300Y24 | 24    | 18,2   |



**Bowl double wall**  
Ciotola doppia parete  
Schüssel, doppelwandig  
Bol à double paroi  
Tazón doble pared

| art.     | Ø cm. | h. cm. |
|----------|-------|--------|
| 12300G18 | 18    | 14,0   |
| 12300G24 | 24    | 18,2   |



**Bowl double wall**  
Ciotola doppia parete  
Schüssel, doppelwandig  
Bol à double paroi  
Tazón doble pared

| art.     | Ø cm. | h. cm. |
|----------|-------|--------|
| 12300B18 | 18    | 14,0   |
| 12300B24 | 24    | 18,2   |



**Bowl double wall**  
Ciotola doppia parete  
Schüssel, doppelwandig  
Bol à double paroi  
Tazón doble pared

| art.     | Ø cm. | h. cm. |
|----------|-------|--------|
| 12300O18 | 18    | 14,0   |
| 12300O24 | 24    | 18,2   |



# ATLANTIC BUFFET SYSTEM

BUFFET & PRESENTATION



Conceived and designed in the round and rectangular versions with different opening systems to meet any need ABS Atlantic Buffet System chafing dishes combine contemporary flexibility and functionality. All the parts of these simple-shaped, stackable, 100% stainless steel hygienic items can be easily taken apart for thorough cleaning.

The line comes from the expertise that only Sambonet Paderno can offer to top catering services. The lid is equipped with a new, transparent window made of unbreakable glass that lets you see the delicacies held in the chafing dishes. The gradual closing mechanism and the special lid removal method make the whole System even more effective.

Pensati e ideati nelle versioni rotonde, rettangolari con aperture differenziate per soddisfare ogni esigenza, gli scaldavivande ABS Atlantic Buffet System interpretano la funzionalità e la flessibilità contemporanea. Semplici nella forma, impilabili, igienici poiché realizzati in acciaio inox, facilmente smontabili in tutte le loro parti per una pulizia impeccabile, gli elementi appartenenti alla linea nascono dall'expertise che solo Sambonet Paderno è in grado di garantire alla ristorazione d'eccellenza. Grazie alla trasparenza del nuovo oblò in vetro temperato, i coperchi offrono visibilità alla prelibatezza dei contenuti degli scaldavivande. Il meccanismo di chiusura graduale e lo speciale metodo di rimozione dei coperchi rende ancora più performante l'intero Sistema.



**TOP UNIT - Chafing dish round**

Scaldavivande tondo  
Chafing Dish, rund  
Chafing dish rond  
Chafing dish redondo

| art.     | Ø cm. | h. cm. | lt. |
|----------|-------|--------|-----|
| 18176-30 | 30    | 15     | 2,8 |
| 18176-36 | 36    | 15     | 5,0 |
| 18176-40 | 40    | 17     | 7,8 |



**TOP UNIT - Chafing dish round**

Scaldavivande tondo  
Chafing Dish, rund  
Chafing dish rond  
Chafing dish redondo

| art.     | Ø cm. | h. cm. | lt. |
|----------|-------|--------|-----|
| 18176I30 | 30    | 15     | 2,8 |
| 18176I36 | 36    | 15     | 5,0 |
| 18176I40 | 40    | 17     | 7,8 |



**TOP UNIT - Chafing dish round**

Scaldavivande tondo  
Chafing Dish, rund  
Chafing dish rond  
Chafing dish redondo

| art.     | Ø cm. | h. cm. | lt. |
|----------|-------|--------|-----|
| 18166-24 | 24    | 15     | 2,0 |
| 18166-30 | 30    | 15     | 2,8 |
| 18166-36 | 36    | 15     | 5,0 |
| 18166-40 | 40    | 17     | 7,8 |



**TOP UNIT - Chafing dish round**

Scaldavivande tondo  
Chafing Dish, rund  
Chafing dish rond  
Chafing dish redondo

| art.     | Ø cm. | h. cm. | lt. |
|----------|-------|--------|-----|
| 18166I30 | 30    | 15     | 2,8 |
| 18166I36 | 36    | 15     | 5,0 |
| 18166I40 | 40    | 17     | 7,8 |



**TOP UNIT - Chafing dish rectangular**

Scaldavivande rettangolare  
Chafing Dish, rechteckig  
Chafing dish rectangulaire  
Chafing dish rectangular

| art.     | dim. cm. | lt. |
|----------|----------|-----|
| 18172-54 | 57x47x18 | 10  |

**Long side opening.** – Apertura lato lungo.



**TOP UNIT - Chafing dish rectangular**

Scaldavivande rettangolare  
Chafing Dish, rechteckig  
Chafing dish rectangulaire  
Chafing dish rectangular

| art.     | dim. cm.     | lt. |
|----------|--------------|-----|
| 18172-56 | 68,5x35,5x18 | 10  |

**Short side opening.** – Apertura lato corto.





**TOP UNIT - Chafing dish rectangular**

Scaldavivande rettangolare  
Chafing Dish, rechteckig  
Chafing dish rectangulaire  
Chafing dish rectangular

| art.     | dim. cm. | lt. |
|----------|----------|-----|
| 18162-54 | 57x47x18 | 10  |

**Long side opening.** – Apertura lato lungo.



**TOP UNIT - Chafing dish rectangular**

Scaldavivande rettangolare  
Chafing Dish, rechteckig  
Chafing dish rectangulaire  
Chafing dish rectangular

| art.     | dim. cm.     | lt. |
|----------|--------------|-----|
| 18162-56 | 68,5x35,5x18 | 10  |

**Short side opening.** – Apertura lato corto.

## ATLANTIC BUFFET SYSTEM INDUCTION HOBS

**ABS-Atlantic Buffet System chafing dishes can be used on any heat source, gas, electric, glass-ceramic and induction\*. We recommend our free-standing (58162-RA) and built-in (58162-RB) cookers.**

**As a matter of fact, these induction cookers are ideal for any buffet where food should be kept at a specific temperature to preserve flavours.**

**\*NOT SUITABLE for induction hobs with frequency identification.**

Gli scaldavivande ABS-Atlantic Buffet System sono ideati per ogni tipo di cottura, gas, elettrica, vetroceramica e induzione\* per la quale si raccomanda l'utilizzo delle piastre proposte dall'azienda, disponibili sia nella versione da appoggio art. 58162-RA sia da incasso art. 58162-RB. Questi piani ad induzione sono infatti l'ideale per tutti i buffet ove indispensabile mantenere i cibi ad una temperatura ottimale per la conservazione dei sapori.

\*NON UTILIZZABILI su piani ad induzione con riconoscimento di frequenza.



**Induction cooker, to be built into counter**

Piastra ad induzione, da incasso  
Induktionsplatte, thekeneinbau  
Plaque à induction, montage en comptoir  
Placa a inducción para emportar

| art.     | dim. cm.   |
|----------|------------|
| 18162-RB | 36X38x12,5 |

**Schott ceran hob, timer (0-180 min.), 1-10 power levels, temperature range 60°C-240°C.**

Piano in vetroceramica Schott, timer 0-180 minuti, 1-10 livelli di potenza, temperatura 60-240°C.



**Induction cooker**

Piastra ad induzione  
Induktionsplatte  
Plaque à induction  
Placa a inducción

| art.     | dim. cm. |
|----------|----------|
| 18162-RA | 30X37x10 |

**Stainless steel body, Schott ceran hob, led display, timer (0-180 min.), 1-10 power levels, temperature range 60°C-240°C.**

Corpo inox, piano in vetroceramica Schott, display a led, timer 0-180 minuti, 1-10 livelli di potenza, temperatura 60-240°C.





### BUILT-IN UNIT - Chafing dish rectangular

Scaldavivande rettangolare  
Chafing Dish, rechteckig  
Chafing dish rectangulaire  
Chafing dish rectangular

| art.     | dim. cm. | lt. | std | V-W     |
|----------|----------|-----|-----|---------|
| 18162A55 | 57x47x18 | 10  |     |         |
| 18162E55 | 57x47x18 | 10  | EU  | 250-360 |
| 18162U55 | 57x47x18 | 10  | US  | 120-450 |

**Long side opening.** – Apertura lato lungo.



| art.     | dim. cm.     | lt. | std | V-W     |
|----------|--------------|-----|-----|---------|
| 18162A57 | 68,5x35,5x18 | 10  |     |         |
| 18162E57 | 68,5x35,5x18 | 10  | EU  | 250-360 |
| 18162U57 | 68,5x35,5x18 | 10  | US  | 120-450 |

**Short side opening.** – Apertura lato corto.



| art.     | dim. cm. | lt. | std | V-W     |
|----------|----------|-----|-----|---------|
| 18172A55 | 57x47x18 | 10  |     |         |
| 18172E55 | 57x47x18 | 10  | EU  | 250-360 |
| 18172U55 | 57x47x18 | 10  | US  | 120-450 |

**Long side opening.** – Apertura lato lungo.



| art.     | dim. cm.     | lt. | std | V-W     |
|----------|--------------|-----|-----|---------|
| 18172A57 | 68,5x35,5x18 | 10  |     |         |
| 18172E57 | 68,5x35,5x18 | 10  | EU  | 250-360 |
| 18172U57 | 68,5x35,5x18 | 10  | US  | 120-450 |

**Short side opening.** – Apertura lato corto.



## ATLANTIC ON STAND UNITS - CON SUPPORTO



**Chafing dish, solid alcohol heating**  
Scaldavivande a combustibile solido  
Chafing Dish mit Brennstoff beheizt  
Chafing dish chauffage combustible solide  
Chafing dish calefacción combustible sólido

| art.     | Ø cm. | h. cm. | lt. |
|----------|-------|--------|-----|
| 18176A30 | 30    | 27     | 2,8 |
| 18176A36 | 36    | 27     | 5,0 |
| 18176A40 | 40    | 28     | 7,8 |



**Chafing dish, solid alcohol heating**  
Scaldavivande a combustibile solido  
Chafing Dish mit Brennstoff beheizt  
Chafing dish chauffage combustible solide  
Chafing dish calefacción combustible sólido

| art.     | Ø cm. | h. cm. | lt. |
|----------|-------|--------|-----|
| 18166A24 | 24    | 27     | 2,0 |
| 18166A30 | 30    | 27     | 2,8 |
| 18166A36 | 36    | 27     | 5,0 |
| 18166A40 | 40    | 28     | 7,8 |



**Chafing dish, electric heating**  
Scaldavivande, riscaldamento elettrico  
Chafing Dish, elektrisch beheizt  
Chafing dish chauffage électrique  
Chafing dish calefacción eléctrica

| art.     | Ø cm. | h. cm. | lt. | std | V-W     |
|----------|-------|--------|-----|-----|---------|
| 18176E30 | 30    | 27     | 2,8 | EU  | 250-190 |
| 18176E36 | 36    | 27     | 5,0 | EU  | 250-190 |
| 18176E40 | 40    | 28     | 7,8 | EU  | 250-190 |
| 18176U36 | 36    | 27     | 5,0 | US  | 120-240 |
| 18176U40 | 40    | 28     | 7,8 | US  | 120-240 |



**Chafing dish, electric heating**  
Scaldavivande, riscaldamento elettrico  
Chafing Dish, elektrisch beheizt  
Chafing dish chauffage électrique  
Chafing dish calefacción eléctrica

| art.     | Ø cm. | h. cm. | lt. | std | V-W     |
|----------|-------|--------|-----|-----|---------|
| 18166E24 | 24    | 27     | 2,0 | EU  | 250-80  |
| 18166E30 | 30    | 27     | 2,8 | EU  | 250-190 |
| 18166E36 | 36    | 27     | 5,0 | EU  | 250-190 |
| 18166E40 | 40    | 28     | 7,8 | EU  | 250-190 |
| 18166U24 | 24    | 27     | 2,0 | US  | 120-170 |
| 18166U36 | 36    | 27     | 5,0 | US  | 120-240 |
| 18166U40 | 40    | 28     | 7,8 | US  | 120-240 |



**Petite marmite**  
Petite marmite  
Petite Marmite  
Petite marmite  
Petite marmite

| art.     | Ø cm. | h. cm. | lt. | std | V-W     |
|----------|-------|--------|-----|-----|---------|
| 18168A24 | 24    | 35     | 7   | -   | -       |
| 18168E24 | 24    | 35     | 7   | EU  | 250-80  |
| 18168U24 | 24    | 35     | 7   | US  | 120-170 |



**Chafing dish rectangular**

Scaldavivande rettangolare

Chafing Dish, rechteckig

Chafing dish rectangulaire

Chafing dish rectangular

| art.     | dim. cm.   | lt. | std | V-W     |
|----------|------------|-----|-----|---------|
| 18172A54 | 57x47x30,5 | 10  | -   | -       |
| 18172E54 | 57x47x30,5 | 10  | EU  | 250-360 |
| 18172U54 | 57x47x30,5 | 10  | US  | 120-450 |



**Chafing dish rectangular**

Scaldavivande rettangolare

Chafing Dish, rechteckig

Chafing dish rectangulaire

Chafing dish rectangular

| art.     | dim. cm.       | lt. | std | V-W     |
|----------|----------------|-----|-----|---------|
| 18172A56 | 68,5x35,5x30,5 | 10  | -   | -       |
| 18172E56 | 68,5x35,5x30,5 | 10  | EU  | 250-360 |
| 18172U56 | 68,5x35,5x30,5 | 10  | US  | 120-450 |



**Chafing dish rectangular**

Scaldavivande rettangolare

Chafing Dish, rechteckig

Chafing dish rectangulaire

Chafing dish rectangular

| art.     | dim. cm.   | lt. | std | V-W     |
|----------|------------|-----|-----|---------|
| 18162A54 | 57x47x30,5 | 10  | -   | -       |
| 18162E54 | 57x47x30,5 | 10  | EU  | 250-360 |
| 18162U54 | 57x47x30,5 | 10  | US  | 120-450 |



**Chafing dish rectangular**

Scaldavivande rettangolare

Chafing Dish, rechteckig

Chafing dish rectangulaire

Chafing dish rectangular

| art.     | dim. cm.       | lt. | std | V-W     |
|----------|----------------|-----|-----|---------|
| 18162A56 | 68,5x35,5x30,5 | 10  | -   | -       |
| 18162E56 | 68,5x35,5x30,5 | 10  | EU  | 250-360 |
| 18162U56 | 68,5x35,5x30,5 | 10  | US  | 120-450 |



**ASIA LINE**



**Chafing dish rectangular**  
Scaldavivande rettangolare  
Chafing Dish, rechteckig  
Chafing dish rectangulaire  
Chafing dish rectangular

| art.     | dim. cm.   | lt. | std | V-W     |
|----------|------------|-----|-----|---------|
| 18132A54 | 67,5x44x42 | 10  | -   | -       |
| 18132E54 | 67,5x44x42 | 10  | EU  | 250-360 |
| 18132U54 | 67,5x44x42 | 10  | US  | 120-450 |



**Chafing dish, to be built in**  
Scaldavivande da incasso  
Einbau Chafing Dish  
Chafing dish encastrable  
Chafing dish encastrable

| art.     | dim. cm.     | lt. | std | V-W     |
|----------|--------------|-----|-----|---------|
| 18132A55 | 67,5x44x34,5 | 10  | -   | -       |
| 18132E55 | 67,5x44x34,5 | 10  | EU  | 250-360 |
| 18132U55 | 67,5x44x34,5 | 10  | US  | 120-450 |



**Chafing dish round**  
Scaldavivande tondo  
Chafing Dish, rund  
Chafing dish rond  
Chafing dish redondo

| art.     | Ø cm. | h. cm. | lt. | std | V-W     |
|----------|-------|--------|-----|-----|---------|
| 18136A33 | 33    | 44     | 3,5 | -   | -       |
| 18136E33 | 33    | 44     | 3,5 | EU  | 250-200 |
| 18136U33 | 33    | 44     | 3,5 | US  | 120-240 |
| 18136A40 | 40    | 58     | 6,0 | -   | -       |
| 18136E40 | 40    | 58     | 6,0 | EU  | 250-360 |
| 18136U40 | 40    | 58     | 6,0 | US  | 120-450 |



**Chafing dish round, to be built in**  
Scaldavivande tondo da incasso  
Einbau Chafing Dish, rund  
Chafing dish rond, encastrable  
Chafing dish redondo encastrable

| art.     | Ø cm. | h. cm. | lt. | std | V-W     |
|----------|-------|--------|-----|-----|---------|
| 18136A34 | 33    | 34,5   | 3,5 | -   | -       |
| 18136E34 | 33    | 34,5   | 3,5 | EU  | 250-200 |
| 18136U34 | 33    | 34,5   | 3,5 | US  | 120-240 |
| 18136A41 | 40    | 43,0   | 6,0 | -   | -       |
| 18136E41 | 40    | 43,0   | 6,0 | EU  | 250-360 |
| 18136U41 | 40    | 43,0   | 6,0 | US  | 120-450 |



**Chafing dish rectangular**

Scaldavivande rettangolare  
Chafing Dish, rechteckig  
Chafing dish rectangulaire  
Chafing dish rectangular

| art.     | dim. cm. | lt. | std | V-W     |
|----------|----------|-----|-----|---------|
| 18152A54 | 67x49x44 | 10  | -   | -       |
| 18152E54 | 67x49x44 | 10  | EU  | 250-360 |
| 18152U54 | 67x49x44 | 10  | US  | 120-450 |



**Chafing dish round**

Scaldavivande tondo  
Chafing Dish, rund  
Chafing dish rond  
Chafing dish redondo

| art.     | Ø cm. | h. cm. | lt. | std | V-W     |
|----------|-------|--------|-----|-----|---------|
| 18156A33 | 33    | 47     | 3,5 | -   | -       |
| 18156E33 | 33    | 47     | 3,5 | EU  | 250-200 |
| 18156U33 | 33    | 47     | 3,5 | US  | 120-240 |
| 18156A40 | 40    | 61     | 6,0 | -   | -       |
| 18156E40 | 40    | 61     | 6,0 | EU  | 250-360 |
| 18156U40 | 40    | 61     | 6,0 | US  | 120-450 |



**Chafing dish rectangular**

Scaldavivande rettangolare  
Chafing Dish, rechteckig  
Chafing dish rectangulaire  
Chafing dish rectangular

| art.     | dim. cm.   | lt. | std | V-W     |
|----------|------------|-----|-----|---------|
| 41690A11 | 63,5x35x32 | 8,5 | -   | -       |
| 41690E11 | 63,5x35x32 | 8,5 | EU  | 250-360 |
| 41690U11 | 63,5x35x32 | 8,5 | US  | 120-450 |

**NEW**



**Chafing dish rectangular**

Scaldavivande rettangolare  
Chafing Dish, rechteckig  
Chafing dish rectangulaire  
Chafing dish rectangular

| art.     | dim. cm.   | lt. | std | V-W     |
|----------|------------|-----|-----|---------|
| 41691A11 | 71,5x52x45 | 8,5 | -   | -       |
| 41691E11 | 71,5x52x45 | 8,5 | EU  | 250-360 |
| 41691U11 | 71,5x52x45 | 8,5 | US  | 120-450 |

**NEW**



**Coffee urn**

Scaldacaffè  
Kaffeedispenser  
Réchaud à café  
Calentador de café

| art.     | dim. cm.     | lt.  | std | V-W     |
|----------|--------------|------|-----|---------|
| 41903A10 | 31x33,5x54,5 | 10,5 | -   | -       |
| 41903E10 | 31x33,5x54,5 | 10,5 | EU  | 220-80  |
| 41903U10 | 31x33,5x54,5 | 10,5 | US  | 110-170 |

**NEW**





**Samovar**

**Pyramid**

**NEW**

| art.     | dim. cm.     | lt. | Tea pot | std | V-W  |
|----------|--------------|-----|---------|-----|------|
| 49856-04 | 35,5x30x45,2 | 4   | Lt 1,2  | EU  | 2500 |

**Teapot with strainer. Cable length approx. 130 cm. With 2 heating elements 2000W and 500W.**  
Teiera con colino. Lunghezza cavo circa 130 cm. Con 2 resistenze 2000W e 500W.



**Samovar**

**2017**

**NEW**

| art.     | dim. cm.     | lt. | Tea pot | std | V-W  |
|----------|--------------|-----|---------|-----|------|
| 49854-03 | 31x27,5x48,5 | 3   | Lt 1,2  | EU  | 1500 |

**Teapot with strainer, cable length approx. 130 cm. – Teiera con colino. Lunghezza cavo circa 130 cm.**



**Samovar**

**Romanov**

**NEW**

| art.     | dim. cm. | lt. | Tea pot | std | V-W  |
|----------|----------|-----|---------|-----|------|
| 49855-05 | 34x27x59 | 5   | Lt 1,3  | EU  | 1800 |

**Teapot with strainer. Cable length approx. 100 cm. With 2 heating elements 1300W and 500W.**  
Teiera con colino. Lunghezza cavo circa 100 cm. Con 2 resistenze 1300W e 500W.



**Samovar**

**3006C**

**NEW**

| art.     | dim. cm.     | lt. | Tea pot | std | V-W  |
|----------|--------------|-----|---------|-----|------|
| 49854-06 | 35,5x30x45,2 | 6   | Lt 1,5  | EU  | 2500 |

**Teapot with strainer. With 2 heating elements 2000W and 500W. – Teiera con colino. Con 2 resistenze 2000W e 500W.**



**Samovar**  
Soraya

NEW

| art.     | dim. cm.     | lt. | Tea pot | std | V-W  |
|----------|--------------|-----|---------|-----|------|
| 49855-10 | 35,2x44,5x69 | 10  | Lt 1,6  | EU  | 3000 |

**Teapot with strainer. Cable length approx. 130 cm. With 2 heating elements 2300W and 700W.**  
Teiera con colino. Lunghezza cavo circa 130 cm. Con 2 resistenze 2300W e 700W.



**Samovar**  
Katharina

NEW

| art.     | dim. cm.       | lt. | Tea pot | std | V-W  |
|----------|----------------|-----|---------|-----|------|
| 49855-15 | 39,5x44,5x74,5 | 15  | Lt 2,0  | EU  | 3000 |

**Teapot with strainer. Cable length approx. 130 cm. With 2 heating elements 2300W and 700W.**  
Teiera con colino. Lunghezza cavo circa 130 cm. Con 2 resistenze 2300W e 700W.



**Coffee percolator**  
Percolatore per caffè  
Kaffee-Perkolator  
Percolateur à café  
Percolator de café

| art.     | Ø cm. | h. cm. | lt. | std | V-W  |
|----------|-------|--------|-----|-----|------|
| 49846-05 | 28    | 38,5   | 4,5 | EU  | 950  |
| 49846-09 | 28    | 38,5   | 9,2 | EU  | 950  |
| 49846-15 | 33    | 54     | 15  | EU  | 1650 |



**Soup kettle**  
Zuppiera  
Suppenwärmer  
Marmite à soupe  
Olla de sopa

| art.     | Ø cm. | h. cm. | lt. | std | V-W         |
|----------|-------|--------|-----|-----|-------------|
| 49847-38 | 38    | 36,5   | 10  | EU  | 230-450/550 |



**Soup kettle**  
Zuppiera  
Suppenwärmer  
Marmite à soupe  
Olla de sopa

| art.     | Ø cm. | h. cm. | lt. | std | V-W     |
|----------|-------|--------|-----|-----|---------|
| 49804-11 | 34    | 33     | 11  | EU  | 230-850 |



**Soup kettle**  
Zuppiera  
Suppenwärmer  
Marmite à soupe  
Olla de sopa

| art.     | Ø cm. | h. cm. | lt. | std | V-W     |
|----------|-------|--------|-----|-----|---------|
| 49847-08 | 33    | 37     | 10  | EU  | 230-400 |



**Soup kettle**  
Zuppiera  
Suppenkessel  
Marmite à soupe  
Olla de sopa

| art.     | Ø cm. | h. cm. | lt. |
|----------|-------|--------|-----|
| 49790-09 | 48    | 32     | 10  |





ACCESSORIES, SPARE PARTS AND COMPONENTS



**Round stand**

Supporto rotondo  
Gestell, rund  
Support rond  
Soporte redondo

| art.     | Ø cm. |
|----------|-------|
| 18166-AA | 24    |
| 18166-AM | 30    |
| 18166-AB | 36    |
| 18166-AC | 40    |



**Rectangular stand**

Supporto rettangolare  
Gestell, rechteckig  
Support rectangulaire  
Soporte rectangular

| art.     | dim. cm. |
|----------|----------|
| 18162-AA | 57x47    |



**Round food pan, stainless steel**

Portavivande tondo, inox  
Einsatzbehälter, rund, Edelstahl Rostfrei  
Bac rond, inox  
Baño-maria redondo, inox

| art.     | Ø cm. | h. cm. | lt. |
|----------|-------|--------|-----|
| 18136-EA | 33    | 6,0    | 3,5 |
| 18136-EB | 40    | 7,5    | 6,0 |

**For ASIA round chafing dishes.** – Per scaldavivande ASIA tondi.



**Round food pan, stainless steel**

Portavivande tondo, inox  
Einsatzbehälter, rund, Edelstahl Rostfrei  
Bac rond, inox  
Baño-maria redondo, inox

| art.     | Ø cm. |
|----------|-------|
| 18166-EG | 24    |
| 18166-EM | 30    |
| 18166-EH | 36    |
| 18166-EI | 40    |

**For ABS round chafing dishes.** – Per scaldavivande ABS tondi.



**Round porcelain insert**

Inserto tondo, porcellana  
Porzellaneinsatz, rund  
Bac rond, porcelaine  
Baño-maria redondo, porcelana

| art.     | Ø cm. | h. cm. |
|----------|-------|--------|
| 44352-30 | 33    | 5,7    |
| 44352-40 | 40    | 7,5    |

**For ASIA round chafing dishes.** – Per scaldavivande ASIA tondi.



**Round porcelain insert, 2 food sections**

Inserto tondo, porcellana, 2 scomparti  
Porzellaneinsatz 2-tlg., rund  
Bac rond, porcelaine, 2 compartements  
Baño-maria redondo, porcelana 2 compartimentos

| art.     | Ø cm. | h. cm. |
|----------|-------|--------|
| 44355-30 | 33    | 5,7    |
| 44355-40 | 40    | 7,5    |

**For ASIA round chafing dishes.** – Per scaldavivande ASIA tondi.





**Round porcelain insert**

Inserto tondo, porcellana  
Porzellaneinsatz, rund  
Bac rond, porcelaine  
Baño-maria redondo, porcelana

| art.     | Ø cm. |
|----------|-------|
| 18166-EL | 30    |
| 18166-EC | 36    |
| 18166-EB | 40    |

**For ABS round chafing dishes. – Per scaldavivande ABS tondi.**



**Round porcelain insert, 2 food sections**

Inserto tondo, porcellana, 2 scomparti  
Porzellaneinsatz 2-tlg., rund  
Bac rond, porcelaine, 2 compartements  
Baño-maria redondo, porcelana 2 compartimentos

| art.     | Ø cm. |
|----------|-------|
| 18166-ED | 36    |
| 18166-EJ | 40    |

**For ABS round chafing dishes. – Per scaldavivande ABS tondi.**



**Food pan GN 1/1, stainless steel**

Bacinella GN 1/1, inox  
GN-Behälter 1/1, Edelstahl Rostfrei  
Bac GN 1/1, inox  
Baño-maria GN 1/1, inox

| art.     | dim. cm.    |
|----------|-------------|
| 14102-04 | 53x32,5x4   |
| 14102-06 | 53x32,5x6,5 |



**Food pan GN 1/1, porcelain**

Bacinella GN 1/1, porcellana  
GN-Behälter 1/1, Porzellan  
Bac GN 1/1, porcelaine  
Baño-maria GN 1/1, porcelana

| art.     | dim. cm.    |
|----------|-------------|
| 44332-03 | 53x32,5x2   |
| 44332-06 | 53x32,5x6,5 |



**Fuel Holder, stainless steel**

Portacombustibile, inox  
Brennstoffhalterung, Edelstahl Rostfrei  
Porte Brûleur, inox  
Contenedor de combustible, inox

| art.     | Ø cm. | h. cm. |
|----------|-------|--------|
| 41809-09 | 9     | 6,5    |

**Suitable for chafing dishes items 41690 and 41691.**

Adatto per gli scaldavivande art. 41690 e 41691.



**Fuel Holder, stainless steel**

Portacombustibile, inox  
Brennstoffhalterung, Edelstahl Rostfrei  
Porte Brûleur, inox  
Contenedor de combustible, inox

| art.     | Ø cm. | h. cm. |
|----------|-------|--------|
| 18132-FB | 10    | 7,5    |

**Suitable for chafing dishes items 18152 and 18156.**

Adatto per gli scaldavivande art. 18152 e 18156.



**Fuel Holder, stainless steel**

Portacombustibile, inox  
Brennstoffhalterung, Edelstahl Rostfrei  
Porte Brûleur, inox  
Contenedor de combustible, inox

| art.     |
|----------|
| 18136-KA |

**Kit for ABS round ø cm 24-30-36. – Set per scaldavivande ABS ø cm 24-30-36.**



**Fuel Holder, stainless steel**

Portacombustibile, inox  
Brennstoffhalterung, Edelstahl Rostfrei  
Porte Brûleur, inox  
Contenedor de combustible, inox

| art.     |
|----------|
| 18132-KA |

**Kit for ABS rectangular and round ø cm 40.**

Set per scaldavivande ABS rettangolari e ø cm 40.



**Soup tureen without lid**  
Zuppiera senza coperchio  
Suppenschüssel ohne Deckel  
Soupière sans couvercle  
Sopera sin tapa

| art.     | Ø cm. | lt. |
|----------|-------|-----|
| 18168-GA | 24    | 7   |



**Jelly fuel**  
Gel combustibile  
Brenngel  
Gel combustibile  
Combustible gel

| art.     | lt. | gr. | U. Pack |
|----------|-----|-----|---------|
| 41695-15 | -   | 200 | 2       |
| 41695-10 | 1   | -   | -       |
| 41695-50 | 5   | -   | -       |
| 41695-90 | 10  | -   | -       |



**Thermoregulator**  
Termoregolatore  
Thermoregler  
Thermorégulateur  
Teromorregulador

| art.     | std |
|----------|-----|
| 18132-AE | EU  |



**Thermoregulator**  
Termoregolatore  
Thermoregler  
Thermorégulateur  
Teromorregulador

| art.     | std |
|----------|-----|
| 18132-AU | US  |

**For rectangular and round units ø cm 30-33-36-40.**  
Per scaldavivande rettangolari e tondi ø cm 30-33-36-40.

**For rectangular and round units ø cm 30-33-36-40.**  
Per scaldavivande rettangolari e tondi ø cm 30-33-36-40.



**Electric heating units**  
Piastrre elettriche  
Elektro-Heizelemente  
Corps de chauffe électriques  
Calentadores eléctricos

| art.     | std | V-W     |
|----------|-----|---------|
| 18136-KE | EU  | 220-200 |
| 18136-KU | US  | 110-240 |

**Cm. 20x20 - For ASIA round chafing dishes cm 33.** – Per scaldavivande ASIA tondo cm 33.



**Electric heating units**  
Piastrre elettriche  
Elektro-Heizelemente  
Corps de chauffe électriques  
Calentadores eléctricos

| art.     | std | V-W     |
|----------|-----|---------|
| 18166-KP | EU  | 220-180 |

**Cm. 20x21 - For ABS round ø cm 30.**  
Per scaldavivande ABS tondo ø cm 30.



**Electric heating units**  
Piastrre elettriche  
Elektro-Heizelemente  
Corps de chauffe électriques  
Calentadores eléctricos

| art.     | std | V-W     |
|----------|-----|---------|
| 18166-KE | EU  | 220-200 |
| 18166-KU | US  | 110-240 |

**Cm. 20x25 - For ABS round ø cm 36-40.**  
Per scaldavivande ABS tondo ø cm 36-40.



**Electric heating units**  
Piastrre elettriche  
Elektro-Heizelemente  
Corps de chauffe électriques  
Calentadores eléctricos

| art.     | std | V-W     |
|----------|-----|---------|
| 18132-KE | EU  | 220-380 |
| 18132-KU | US  | 110-450 |

**Cm. 20x25 - For ASIA rectangular and round chafing dishes cm 40.** – Per scaldavivande ASIA rettangolari e tondi cm 40.



**Electric heating units**  
Piastrre elettriche  
Elektro-Heizelemente  
Corps de chauffe électriques  
Calentadores eléctricos

| art.     | std | V-W     |
|----------|-----|---------|
| 18162-KE | EU  | 220-380 |
| 18162-KU | US  | 110-450 |

**Cm. 20x25 - For ABS rectangular.**  
Per scaldavivande ABS rettangolari.



**Electric heating units**  
Piastrre elettriche  
Elektro-Heizelemente  
Corps de chauffe électriques  
Calentadores eléctricos

| art.     | std | V-W     |
|----------|-----|---------|
| 18341-KE | EU  | 220-80  |
| 18341-KU | US  | 110-170 |

**Cm. Ø 13,5 - For ABS round ø cm 24.**  
Per scaldavivande ABS tondo ø cm 24.

# SERIES VERSAILLES

DINING ROOM TROLLEYS  
CARRELLI SALA



Main structure and tops in plywood with reinforced edges. Legs in beechwood. Standard finishing rosewood color. Other colors: walnut, mahogany and oak. Standard swivel casters in antistatic rubber, on request polyurethane casters. All trolleys are available equipped with rubber bumper.

Struttura portante, piani di servizio in legno multistrato con bordi massicci. Gambe in massello di faggio. Finitura standard tinta palissandro. Su richiesta colori: noce, mogano e rovere. Ruote standard in gomma antistatica, optional ruote in poliuretano. Tutti i carrelli possono essere dotati di profilo paraurti.



**Roast beef/stew trolley**

Carrello arrostiti/bolliti  
Rinderbrust-/Fleischgerichtewagen  
Chariot à rôtis  
Carro roast beef

| art.     | dim. cm.   | Kg. | V   | W   | color    | col. |
|----------|------------|-----|-----|-----|----------|------|
| 18874-11 | 126x62x109 | 54  | 120 | 600 | rosewood | ●    |
| 18874M11 | 126x62x109 | 54  | 120 | 600 | mahogany | ●    |
| 18874N11 | 126x62x109 | 54  | 120 | 600 | walnut   | ●    |
| 18874R11 | 126x62x109 | 54  | 120 | 600 | oak      | ●    |
| 18874-22 | 126x62x109 | 54  | 230 | 700 | rosewood | ●    |
| 18874M22 | 126x62x109 | 54  | 230 | 700 | mahogany | ●    |
| 18874N22 | 126x62x109 | 54  | 230 | 700 | walnut   | ●    |
| 18874R22 | 126x62x109 | 54  | 230 | 700 | oak      | ●    |

**18-10 s/s revolving top adjustable up to 180°, mirror polish finishing - 4 swivel casters, 2 with brakes, bain-marie tank with 3 GN 1/2 10 litres each - removable wilsonart cutting board mm 354x265 revolving plate rack and removable knife holder in 18-10 s/s - 2 taps for water discharge - 2 heating units 700W each - 1 built in plug, backside - 3 built-in plugs, deck downside - 2 pipe plugs - cable - 3 switches, (1 magneto-thermic).** – Cloche inox 18-10 lucido a specchio, apertura a scomparsa a 180° - 4 ruote pivotanti, 2 con freno – vasca bagnomaria con 3 portavivande GN 1/2 da lt 10 cad. - tagliere mobile in wilsonart, mm 354x265 - portapiatti ribaltabile e portacoltelli estraibile in acciaio inox 18-10 - 2 rubinetti di scarico a sfera - 2 piastre elettriche da 700W cad. - 1 spina ad incasso (posteriore carrello) - 3 prese ad incasso (sotto piano carrello) - 2 spine a pipa - cavo di alimentazione - 3 interruttori di cui 1 magnetotermico.



**Flambé trolley**

Carrello flambé  
Flambierwagen  
Chariot à flamber  
Carro flambé

| art.     | dim. cm.      | Kg.  | color    | col. |
|----------|---------------|------|----------|------|
| 18876-00 | 122x58,5x89,5 | 44,5 | rosewood | ●    |
| 18876M00 | 122x58,5x89,5 | 44,5 | mahogany | ●    |
| 18876N00 | 122x58,5x89,5 | 44,5 | walnut   | ●    |
| 18876R00 | 122x58,5x89,5 | 44,5 | oak      | ●    |

**4 swivel casters, 2 with brakes - upper deck in 18-10 stainless steel mm 540x1042 with bottle holder protection ring - 2 lower wooden decks - cabinet for gas cylinder - gas/burning/lighting unit - piezoelectric lighting device - operating with liquid butan gas, 2,75 kg rechargeable cylinder (lasting for 20 hours about) or 1,8 kg cylinder - trolley supplied without cylinder.**

4 ruote pivotanti di cui 2 con freno - pianale inox mm 540x1042 completo di barriera portabottiglie - 2 piani d'appoggio inferiori in legno - vano porta bombole con sportello di chiusura - gruppo gas/bruciatore/accenditore - dispositivo di accensione piezoelettrico - funzionamento a gas liquido butano in bombola ricaricabile da kg 2,75 (autonomia 20 ore circa) oppure da kg 1,8 - bombola NON fornita.



**Standard gueridon trolley**

Carrello gueridon, standard  
Gueridonwagen, Standard  
Chariot gueridon, standard  
Carro gueridon estándar

| art.     | dim. cm.     | Kg.  | color    | col. |
|----------|--------------|------|----------|------|
| 18886-00 | 77,5x51x74,5 | 14,5 | rosewood | ●    |
| 18886M00 | 77,5x51x74,5 | 14,5 | mahogany | ●    |
| 18886N00 | 77,5x51x74,5 | 14,5 | walnut   | ●    |
| 18886R00 | 77,5x51x74,5 | 14,5 | oak      | ●    |

**4 swivel casters without brakes. Upon request, the trolley can be supplied equipped with intermediate shelf.** – 4 ruote pivotanti, senza freno. Su richiesta è possibile fornire il carrello dotato di piano intermedio.



**De luxe gueridon trolley**

Carrello gueridon, de luxe  
Gueridonwagen, Luxus-Ausführung  
Chariot gueridon, de luxe  
Carro gueridon, de luxe

| art.     | dim. cm.     | Kg.  | color    | col. |
|----------|--------------|------|----------|------|
| 18887-00 | 77,5x51x74,5 | 16,5 | rosewood | ●    |
| 18887M00 | 77,5x51x74,5 | 16,5 | mahogany | ●    |
| 18887N00 | 77,5x51x74,5 | 16,5 | walnut   | ●    |
| 18887R00 | 77,5x51x74,5 | 16,5 | oak      | ●    |

**4 swivel casters without brakes - 6 compartments drawer – removable upper deck.** – 4 ruote pivotanti, senza freno - cassetteria a sei scomparti – piano d'appoggio estraibile.





**Flambé trolley, electric**

Carrello flambé, elettrico  
Flambierwagen, elektrisch  
Chariot à flamber, électrique  
Carro flambé, eléctrico

| art.     | dim. cm.      | Kg.  | V   | W    | color    | col. |
|----------|---------------|------|-----|------|----------|------|
| 18876-01 | 122x58,5x89,5 | 44,5 | 230 | 2300 | rosewood | ●    |
| 18876M01 | 122x58,5x89,5 | 44,5 | 230 | 2300 | mahogany | ●    |
| 18876N01 | 122x58,5x89,5 | 44,5 | 230 | 2300 | walnut   | ●    |
| 18876R01 | 122x58,5x89,5 | 44,5 | 230 | 2300 | oak      | ●    |

**4 swivel casters, 2 with brakes – upper deck in 18-10 stainless steel mm 540x1042 with protection ring – 2 lower wooden decks - built-in electric heating unit, high-light, ø 32 cm, ceramic heating surface ø 26 cm - 1 built-in plug, backside - cable - adjustable heat control unit and 1 magneto termic switch. – 4 ruote pivotanti di cui 2 con freno - pianale inox mm 540x1042 completo di barriera perimetrale - 2 piani d'appoggio inferiori in legno - piastra elettrica high-light da incasso ø 32 cm, piano riscaldante in vetroceramica ø 26 cm - 1 spina ad incasso (posteriore carrello) - cavo di alimentazione - regolatore di energia ed interruttore magnetotermico.**



**Flambé trolley, 2 burners**

Carrello flambé, 2 fuochi  
Flambierwagen, 2 Brenner  
Chariot à flamber, 2 feux  
Carro flambé, 2 fuegos

| art.     | dim. cm.      | Kg.  | color    | col. |
|----------|---------------|------|----------|------|
| 18877-00 | 122x58,5x89,5 | 46,5 | rosewood | ●    |
| 18877M00 | 122x58,5x89,5 | 46,5 | mahogany | ●    |
| 18877N00 | 122x58,5x89,5 | 46,5 | walnut   | ●    |
| 18877R00 | 122x58,5x89,5 | 46,5 | oak      | ●    |

**4 swivel casters, 2 with brakes - upper deck in 18-10 stainless steel mm 540x1042 with protection ring - 2 lower wooden decks - cabinet for gas cylinder – 2 gas/burning/lighting units - piezoelectric lighting device - operating with liquid butan gas, 2,75 kg rechargeable cylinder (lasting for 20 hours about) or 1,8 kg cylinder - trolley supplied without cylinder.**

**4 ruote pivotanti di cui 2 con freno - pianale inox mm 540x1042 completo di barriera perimetrale – 2 piani d'appoggio inferiori in legno - vano porta bombole con sportello di chiusura- 2 gruppi gas/bruciatore/accenditore - dispositivo di accensione piezoelettrico - funzionamento a gas liquido butano in bombola ricaricabile da kg 2,75 (autonomia 20 ore circa) oppure da kg 1,8 - bombola NON fornita.**



**Mini flambé trolley**

Carrello mini-flambé  
Flambierwagen, Mini-Ausführung  
Chariot à flamber, mini  
Mini carro flambé

| art.     | dim. cm.     | Kg. | color    | col. |
|----------|--------------|-----|----------|------|
| 18875-00 | 77,5x51x74,5 | 22  | rosewood | ●    |
| 18875M00 | 77,5x51x74,5 | 22  | mahogany | ●    |
| 18875N00 | 77,5x51x74,5 | 22  | walnut   | ●    |
| 18875R00 | 77,5x51x74,5 | 22  | oak      | ●    |

**4 swivel casters without brakes - upper deck in 18-10 stainless steel, satin finishing - lower deck with bottle holder. – 4 ruote pivotanti, senza freno - piano superiore in acciaio inox 18-10, satinato - vano inferiore con portabottiglie.**



**Hors d'oeuvre trolley**

Carrello antipasti  
Vorspeisewagen  
Chariot à hors d'oeuvres  
Carro entremeses

| art.     | dim. cm.   | Kg. | color    | col. |
|----------|------------|-----|----------|------|
| 18878-00 | 122x62x106 | 38  | rosewood | ●    |
| 18878M00 | 122x62x106 | 38  | mahogany | ●    |
| 18878N00 | 122x62x106 | 38  | walnut   | ●    |
| 18878R00 | 122x62x106 | 38  | oak      | ●    |

**4 swivel casters, 2 with brakes – methacrylate revolving cloche – hors d'oeuvre inserts carrying deck in 18-10 s/s with protection ring - 9 hors d'oeuvre glass inserts, mm 123x203. Upon request, the trolley can be supplied equipped with intermediate shelf. – 4 ruote pivotanti, 2 con freno - cupola in metacrilato con apertura a scomparsa - piano porta-vaschette antipasti in acciaio inox 18-10 con barriera perimetrale - 9 vaschette antipasti in vetro, dim. mm 123 x 203. Su richiesta è possibile fornire il carrello dotato di piano intermedio.**



#### Cooled hors d'oeuvre trolley

Carrello antipasti, refrigerato  
Vorspeisewagen, gekühlt  
Chariot à hors d'oeuvres, réfrigéré  
Carro entremeses, refrigerado

| art.     | dim. cm.   | Kg. | color    | col. |
|----------|------------|-----|----------|------|
| 18879-00 | 122x62x106 | 38  | rosewood | ●    |
| 18879M00 | 122x62x106 | 38  | mahogany | ●    |
| 18879N00 | 122x62x106 | 38  | walnut   | ●    |
| 18879R00 | 122x62x106 | 38  | oak      | ●    |

**4 swivel casters, 2 with brakes - methacrylate revolving cloche – eutectic pads container with 18-10 stainless steel cover - 8 eutectic pads 2,2 lbs each, mm 170x200 - 9 hors d'oeuvre glass inserts, mm 123x203. Upon request, the trolley can be supplied equipped with intermediate shelf. – 4 ruote pivotanti di cui 2 con freno - cupola in metacrilato, con apertura a scomparsa - copertura vasca per contenitori eutettici in acciaio inox 18-10 - 8 contenitori eutettici da kg 1 cadauno, dim. mm 170 x 200 - 9 vaschette antipasti in vetro, dim. mm 123 x 203. Su richiesta è possibile fornire il carrello dotato di piano intermedio.**



#### Patisserie trolley

Carrello pasticceria Omicron  
Kuchen-/Nachspeisewagen  
Chariot à pâtisserie  
Carro postres

| art.     | dim. cm.     | Kg. | color    | col. |
|----------|--------------|-----|----------|------|
| 18880-00 | 113x56,5x104 | 57  | rosewood | ●    |
| 18880M00 | 113x56,5x104 | 57  | mahogany | ●    |
| 18880N00 | 113x56,5x104 | 57  | walnut   | ●    |
| 18880R00 | 113x56,5x104 | 57  | oak      | ●    |

**Methacrylate revolving cloche, bifrontal rotation – 4 swivel casters, 2 with brakes - 1 upper fixed deck in metacrilato mm 200x750 - 1 upper removable deck in metacrilato mm 400x750 – 2 revolving plate racks in 18-10 stainless steel - 2 lower wooden decks. – Cupola tonda in metacrilato, montata su guide laterali, che ne permettono la rotazione nei due sensi - 4 ruote pivotanti di cui 2 con freno - 1 piano fisso in metacrilato mm 200x750 - 1 piano mobile in metacrilato mm 400x750 - 2 portapiatti ribaltabili in acciaio inox 18-10 - 2 piani d'appoggio inferiori in legno.**



#### Cake and cheese trolley

Carrello dolci-formaggi  
Dessert-/Käsewagen  
Chariot à fromages et desserts  
Carro postres/quesos

| art.     | dim. cm.   | Kg. | color    | col. |
|----------|------------|-----|----------|------|
| 18882-00 | 122x62x106 | 38  | rosewood | ●    |
| 18882M00 | 122x62x106 | 38  | mahogany | ●    |
| 18882N00 | 122x62x106 | 38  | walnut   | ●    |
| 18882R00 | 122x62x106 | 38  | oak      | ●    |

**4 swivel casters, 2 with brakes - methacrylate revolving cloche - beech texwood cutting board mm 728x424 - revolving plate rack in 18-10 stainless steel. Upon request, the trolley can be supplied equipped with intermediate shelf. – 4 ruote pivotanti di cui 2 con freno - cupola in metacrilato, con apertura a scomparsa - tagliere in texwood faggio naturale mm 728 x 424 - portapiatti ribaltabile in acciaio inox 18-10. Su richiesta è possibile fornire il carrello dotato di piano intermedio.**



#### Cooled cake trolley

Carrello dolci, refrigerato  
Dessertwagen, gekühlt  
Chariot à desserts, réfrigéré  
Carro postres, refrigerado

| art.     | dim. cm.   | Kg.  | color    | col. |
|----------|------------|------|----------|------|
| 18884-00 | 122x62x106 | 47,5 | rosewood | ●    |
| 18884M00 | 122x62x106 | 47,5 | mahogany | ●    |
| 18884N00 | 122x62x106 | 47,5 | walnut   | ●    |
| 18884R00 | 122x62x106 | 47,5 | oak      | ●    |

**4 swivel casters, 2 with brakes - metacrilato revolving cloche – eutectic pads container with 18-10 stainless steel cover - 8 eutectic pads 2,2 lbs each, mm 170x200 - revolving plate rack in 18-10 stainless steel. Upon request, the trolley can be supplied equipped with intermediate shelf. – 4 ruote pivotanti di cui 2 con freno - cupola in metacrilato, con apertura a scomparsa - vaschetta porta contenitori eutettici con copertura in acciaio inox 18-10 - 8 contenitori eutettici da kg 1 cadauno, mm 170x200 - portapiatti ribaltabile in acciaio inox 18-10. Su richiesta è possibile fornire il carrello dotato di piano intermedio.**





**Cooled mini cheese trolley**

Carrello mini-formaggi, refrigerato  
Käsewagen, gekühlt, Mini-Ausführung  
Chariot à fromages, réfrigéré, mini  
Mini carro quesos, refrigerado

| art.     | dim. cm.   | Kg.  | color    | col. |
|----------|------------|------|----------|------|
| 18895-00 | 77,5x51x94 | 16,5 | rosewood | ●    |
| 18895M00 | 77,5x51x94 | 16,5 | mahogany | ●    |
| 18895N00 | 77,5x51x94 | 16,5 | walnut   | ●    |
| 18895R00 | 77,5x51x94 | 16,5 | oak      | ●    |

**4 swivel casters without brakes - metacrilat roll-top cover, opening at 90° - eutectic pads container with stainless steel cover (eutectic pads incl.) - 1 removable cutting board, GN 1/1 - revolving plate rack in stainless steel.**  
4 ruote pivotanti senza freno - cupola in metacrilato, con apertura a 90° - vaschetta porta contenitori eutettici (eutettici inclusi) con copertura in acciaio inox - 1 tagliere mobile, GN 1/1 - portapiatti ribaltabile in acciaio inox.



**Wine trolley**

Carrello vini  
Weinwagen  
Chariot à vins  
Carro de vinos

| art.     | dim. cm.  | Kg. | color    | col. |
|----------|-----------|-----|----------|------|
| 18897-00 | 122x62x92 | 39  | rosewood | ●    |
| 18897M00 | 122x62x92 | 39  | mahogany | ●    |
| 18897N00 | 122x62x92 | 39  | walnut   | ●    |
| 18897R00 | 122x62x92 | 39  | oak      | ●    |

**4 swivel casters, 2 with brakes - upper deck with stainless steel bottle holder ring - bottle caps and wine card compartment - 6 compartments for bottle coolers (bottle coolers included) - glass rack, deck downside - lower deck with bottle rack, 12 compartments. - 4 ruote pivotanti di cui 2 con freno - barriera porta bottiglie in acciaio inox - contenitore per tappi e carta vini - vano con 6 glacette (glacette incluse) - rastrelliera porta bicchieri, sotto piano carrello - piano inferiore con rastrelliera porta bottiglie, 12 posti.**



**Liqueur trolley**

Carrello liquori  
Aperitif-/Digestivwagen  
Chariot à liqueurs  
Carro licores

| art.     | dim. cm.     | Kg. | color    | col. |
|----------|--------------|-----|----------|------|
| 18889-00 | 124x68,5x104 | 37  | rosewood | ●    |
| 18889M00 | 124x68,5x104 | 37  | mahogany | ●    |
| 18889N00 | 124x68,5x104 | 37  | walnut   | ●    |
| 18889R00 | 124x68,5x104 | 37  | oak      | ●    |

**4 swivel casters, 2 with brakes - bottle holder protection ring in 18-10 stainless steel. - 4 ruote pivotanti di cui 2 con freno - barriera portabottiglie in acciaio inox 18-10.**



**Serving trolley**

Carrello servizio  
Servierwagen  
Chariot à servir  
Carro de servicio

| art.     | dim. cm.      | Kg.  | color    | col. |
|----------|---------------|------|----------|------|
| 18891-00 | 122x58,5x89,5 | 35,5 | rosewood | ●    |
| 18891M00 | 122x58,5x89,5 | 35,5 | mahogany | ●    |
| 18891N00 | 122x58,5x89,5 | 35,5 | walnut   | ●    |
| 18891R00 | 122x58,5x89,5 | 35,5 | oak      | ●    |

**4 swivel casters, 2 with brakes - removable upper deck and wooden drawer. Upon request, the trolley can be supplied equipped with intermediate shelf. 4 ruote pivotanti di cui 2 con freno - piano estraibile e cassetto in legno. Su richiesta è possibile fornire il carrello dotato di piano intermedio.**





**Sherbet/ice cream trolley**

Carrello sorbetti  
Sorbetwagen  
Chariot à sorbets/glacés  
Carro sorbetes

| art.     | dim. cm.  | Kg. | color    | col. |
|----------|-----------|-----|----------|------|
| 18893-00 | 122x62x93 | 43  | rosewood | ●    |
| 18893M00 | 122x62x93 | 43  | mahogany | ●    |
| 18893N00 | 122x62x93 | 43  | walnut   | ●    |
| 18893R00 | 122x62x93 | 43  | oak      | ●    |

**4 swivel casters, 2 with brakes - 4 18-10 stainless steel insulated sherbet holders (lt 1,2 each) - flatware drawer - revolving plate rack and ice cream scoops holder in stainless steel.** – 4 ruote pivotanti di cui 2 con freno - 4 sorbettiere termiche in acciaio inox 18-10 da lt 1,2 cadauna - cassetto portaposate - portapiatti ribaltabile e portapalette-gelato in acciaio inox 18-10.



**Round trolley**

Carrello tondo  
Servierwagen, rund  
Chariot rond  
Carro redondo

| art.     | Ø cm. | h. cm. | Kg. | color    | col. |
|----------|-------|--------|-----|----------|------|
| 18888-00 | 60    | 89,5   | 23  | rosewood | ●    |
| 18888M00 | 60    | 89,5   | 23  | mahogany | ●    |
| 18888N00 | 60    | 89,5   | 23  | walnut   | ●    |
| 18888R00 | 60    | 89,5   | 23  | oak      | ●    |

**4 swivel casters without brakes – removable upper deck - perimeter barrier.**  
4 ruote pivotanti, senza freno - piano d'appoggio laterale estraibile - barriera perimetrale.



PP

**Serving trolley**

Carrello servizio  
Servierwagen  
Chariot à servir  
Carro de servicio

| art.     | dim. cm. | col. |
|----------|----------|------|
| 49995-04 | 97x51x99 | ●    |

**Swivel casters for easy manoeuvrability. Ergonomic handles, high load capacity 135 kg (45 kg per shelf). Ultra-quiet mark-resistant casters.**  
Maniglie ergonomiche arrotondate, pannelli laterali e bordo paraurti arrotondato. Portata 135 kg (45 kg per ripiano). Ruote girevoli, antirattacchia e silenziose.



W

**Breakfast tray with legs**

Vassoio colazione con gambe  
Frühstückstablett mit Beinen  
Plateau petit déjeuner avec jambes  
Bandeja desayuno con patas

| art.     | dim. cm.     | col. |
|----------|--------------|------|
| 19902-38 | 58,5x38,5x30 | ●    |

Wenge. – Wengè



W

**Room service tray**

Vassoio room service  
Zimmerservice-Tablett  
Plateau room-service  
Bandeja room service

| art.     | dim. cm. | col. |
|----------|----------|------|
| 19901-35 | 52x35    | ●    |
| 19901-40 | 60x40    | ●    |
| 19901-47 | 71x47    | ●    |

Dark walnut. – Noce scuro.



2-tier service trolleys with hygienic plexiglas dome cover double side opening and 4 standard swivel wheels, 2 with brake. A new way of serving food safely and fighting COVID 19 by clearly dividing the kitchen side and the service side to avoid contamination and have the most hygienic service possible.

Carrelli di servizio a 2 piani dotati di cupola igienica in plexiglas apribile sui 2 lati e 4 ruote girevoli di cui 2 con freno. Un nuovo modo di servire gli alimenti in sicurezza e combattere COVID 19 dividendo chiaramente il lato cucina e il lato servizio per evitare contaminazioni e avere il servizio più igienico possibile.



**Serving trolley**

Carrello servizio  
Servierwagen  
Chariot à servir  
Carro de servicio

art. dim. cm.  
49996-00 89x47x103

Chromed structure, shelves elm color, perimeter barrier lower deck, sliding plate shelf upper deck, wheels Ø 100 mm. – Struttura cromata, ripiani color olmo, spondine di contenimento piano inferiore, pianetto estraibile, ruote Ø 100 mm.



**Serving trolley**

Carrello servizio  
Servierwagen  
Chariot à servir  
Carro de servicio

art. dim. cm.  
49996-01 89x47x103

Chromed structure, shelves elm color, wheels Ø 100 mm. – Struttura cromata, ripiani color olmo, ruote Ø 100 mm.



**Serving trolley**

Carrello servizio  
Servierwagen  
Chariot à servir  
Carro de servicio

art. dim. cm.  
49996-05 89x47x103

Painted structure, shelves grey color, wheels Ø 100 mm. – Struttura verniciata, ripiani colore grigio, ruote Ø 100 mm.





A range of service tables and trolleys designed to allow guests to comfortably and safely receive and consume breakfast or dinner in their room. Hot boxes made of AISI 304 stainless steel with double insulated wall. Analogic thermostat 30-90°C with indicator light. Equipped with two inner height-adjustable grids. Suitable for dishes up to Ø 32 cm. Refrigerated boxes made of AISI 304 stainless steel with double insulated wall with chilling pack -32°C inserted in a condensate collector basket placed on the upper grid. Chill for about 5 hours. Room service tables: chromes tube structure, 2 castors with brake. Top Ø 90 cm made of CDF (Compact Density Fibreboard). Can carry up to 2 boxes.

Una gamma di tavoli e carrelli per il servizio in camera per permettere agli ospiti di ricevere e consumare comodamente e in piena sicurezza la colazione o la cena in stanza. Box termici in acciaio inox AISI 304 a doppia parete coibentata. Termostato analogico 30-90°C con spia luminosa di funzionamento. Forniti con due griglie interne regolabili in altezza. Idonei per piatti fino a Ø 32 cm. Box refrigerati in acciaio inox AISI 304 a doppia parete coibentata. Refrigerazione a mezzo di una piastra eutettica -32°C inserita in un cesto di raccolta posizionato sulla griglia superiore. Raffreddare per c.ca 5 ore. Tavolini: struttura in tubo cromato, 2 ruote con freno. Piano Ø 90 cm in CDF (Compact Density Fibreboard). Possono trasportare fino a 2 box.



**Thermic hot box**

Box termico  
Speisen-Kaste  
Caisson thermique  
Cajón térmico

| art.     | dim. cm.     | W   |
|----------|--------------|-----|
| 44094-00 | 38x40,5x51,2 | 500 |

**Refrigerated box**

Box refrigerato  
Speisen-Kaste  
Caisson réfrigéré  
Cajón refrigerado

| art.     | dim. cm.   |
|----------|------------|
| 44094R00 | 38x40,5x51 |



**Room service table**

Tavolino room service  
Zimmerservice-Tisch  
Table de restauration en chambre  
Carrito de servicio de habitaciones

| art.     | Ø cm.   | h. cm. |
|----------|---------|--------|
| 44094-01 | 90/54,6 | 77     |



**Room service table with hot box**

Tavolino room service con hot box  
Zimmerservice-Tisch mit Hot Box  
Table de restauration en chambre avec hot box  
Carrito de servicio de habitaciones con hot box

| art.     | Ø cm.   | h. cm. | W   |
|----------|---------|--------|-----|
| 44094-02 | 90/54,6 | 77     | 500 |

**44094-00 + 44094-01.**

With fold down flaps for easy crossing of doors and lifts.  
Con flaps pieghevoli per attraversare porte e ascensori.



**Room service table**

Tavolino room service  
Zimmerservice-Tisch  
Table de restauration en chambre  
Carrito de servicio de habitaciones

art. Ø cm. h. cm. closed/chiuso  
44094-03 90/54,6 78,6 74x54x117

**With fold down flaps for easy crossing of doors and lifts. With capsizable top for stacking when not in use.** – Con flaps pieghevoli per attraversare porte e ascensori. Ribaltabile e impilabile quando non in uso.



**Room service table with hot box**

Tavolino room service con hot box  
Zimmerservice-Tisch mit Hot Box  
Table de restauration en chambre avec hot box  
Carrito de servicio de habitaciones con hot box

art. Ø cm. h. cm. W  
44094-04 90/54,6 78,6 500

**44094-00 + 44094-03.**



**Room service table**

Tavolino room service  
Zimmerservice-Tisch  
Table de restauration en chambre  
Carrito de servicio de habitaciones

art. Ø cm. h. cm. closed/chiuso  
44094-05 90/73 76 73x33x98

**With fold down flaps for easy crossing of doors and lifts. Foldable for saving space when not in use.** – Con flaps pieghevoli per attraversare porte e ascensori. Pieghevole per ridurre l'ingombro quando non in uso.



**Room service table with hot box**

Tavolino room service con hot box  
Zimmerservice-Tisch mit Hot Box  
Table de restauration en chambre avec hot box  
Carrito de servicio de habitaciones con hot box

art. Ø cm. h. cm. W  
44094-06 90/73 76 500

**44094-00 + 44094-05.**



**Serving trolley**

Carrello servizio  
Servierwagen  
Chariot à servir  
Carro de servicio

art. des. dim. cm.  
49996-01 trolley 89x47x103  
44094-00 hot box 38x40,5x51,2  
44094R00 cold box 38x40,5x51

**With hygienic plexiglas dome cover double side opening. The trolley can be equipped with 2 hot and/or cold boxes. Ideal for maintaining the temperature of food and for the room service.** – Cupola igienica in plexiglas apribile sui 2 lati. Il carrello è equipaggiabile con 2 box termici caldi e/o freddi. Ideale per mantenere la temperatura delle portate e per il servizio in camera.



**Serving trolley**

Carrello servizio  
Servierwagen  
Chariot à servir  
Carro de servicio

art. des. dim. cm.  
49996-05 trolley 89x47x103  
44094-00 hot box 38x40,5x51,2  
44094R00 cold box 38x40,5x51

**With hygienic plexiglas dome cover double side opening. The trolley can be equipped with 2 hot and/or cold boxes. Ideal for maintaining the temperature of food and for the room service.** – Con cupola igienica in plexiglas apribile sui 2 lati. Il carrello è equipaggiabile con 2 box termici caldi e/o freddi. Ideale per mantenere la temperatura delle portate e per il servizio in camera.



# SERIES 14000

STORAGE & TRANSPORT  
STOCCAGGIO E TRASPORTO



Molded in one-piece with double-wall construction made of polypropylene. Resistant to shock, high temperatures and chemicals. Designed to give optimum protection to glass and chinaware as well as to maximise water circulation and drying in professional dishwasher. Easy and quickly stackable without tools or screws. Base racks have comfortable hand grips on all four sides facilitating handling.

Realizzati in polipropilene, stampati unipezzo a doppio spessore. Resistenti agli urti ed alte temperature, agenti chimici e residui alimentari. Concepiti per assicurare una protezione ottimale a bicchieri e stoviglie, il loro design permette inoltre una perfetta circolazione dell'acqua di lavaggio ed una rapida e perfetta asciugatura. Facili e veloci da impilare. Leggeri e maneggevoli, tutti i cestelli di base sono dotati di maniglie integrali su tutti i lati.





**9-Compartment base**

Cestello 9 bicchieri  
Grundkorb für 9 Gläser  
Panier de base 9 verres  
Cesta 9 compartimentos

art. mm.  
14001-09 500x500x103

**Compartments / Scoparti 151x151x42 mm.  
ø max 151 mm.**



**9-Compartment extender**

Estensore per cestello 9 bicchieri  
Aufsatz zum Grundkorb für 9 Gläser  
Réhausse pour panier de base 9 verres  
Extensión 9 compartimentos

art. mm.  
14003-09 500x500x45

**Compartments / Scoparti 151x151x88 mm.  
ø max 151 mm.**



**16-Compartment base**

Cestello 16 bicchieri  
Grundkorb für 16 Gläser  
Panier de base 16 verres  
Cesta 16 compartimentos

art. mm.  
14001-16 500x500x103

**Compartments / Scoparti 112x112x88 mm.  
ø max 112 mm.**



**16-Compartment extender**

Estensore per cestello 16 bicchieri  
Aufsatz zum Grundkorb für 16 Gläser  
Réhausse pour panier de base 16 verres  
Extensión 16 compartimentos

art. mm.  
14003-16 500x500x45

**Compartments / Scoparti 112x112x42 mm.  
ø max 112 mm.**



**25-Compartment base**

Cestello 25 bicchieri  
Grundkorb für 25 Gläser  
Panier de base 25 verres  
Cesta 25 compartimentos

art. mm.  
14001-25 500x500x103

**Compartments / Scoparti 88x88x88 mm.  
ø max 88 mm.**



**25-Compartment extender**

Estensore per cestello 25 bicchieri  
Aufsatz zum Grundkorb für 25 Gläser  
Réhausse pour panier de base 25 verres  
Extensión 25 compartimentos

art. mm.  
14003-25 500x500x45

**Compartments / Scoparti 88x88x42 mm.  
ø max 88 mm.**



**36-Compartment base**

Cestello 36 bicchieri  
Grundkorb für 36 Gläser  
Panier de base 36 verres  
Cesta 36 compartimentos

art. mm.  
14001-36 500x500x103

**Compartments / Scoparti 73x73x88 mm.  
ø max 73 mm.**



**36-Compartment extender**

Estensore per cestello 36 bicchieri  
Aufsatz zum Grundkorb für 36 Gläser  
Réhausse pour panier de base 36 verres  
Extensión 36 compartimentos

art. mm.  
14003-36 500x500x45

**Compartments / Scoparti 73x73x42 mm.  
ø max 73 mm.**



**49-Compartment base**

Cestello 49 bicchieri  
Grundkorb für 49 Gläser  
Panier de base 49 verres  
Cesta 49 compartimentos

art. mm.  
14001-49 500x500x103

**Compartments / Scoparti 62x62x42 mm.  
ø max 62 mm.**



**49-Compartment extender**  
 Estensore per cestello 49 bicchieri  
 Aufsatz zum Grundkorb für 49 Gläser  
 Réhausse pour panier de base 49 verres  
 Extensión 49 compartimentos

art. mm.  
 14003-49 500x500x45

**Compartments / Scomparti 62x62x42 mm.  
 ø max 62 mm.**



**Open extender**  
 Estensore aperto  
 Universalrand ohne Einteilung  
 Réhausse sans cloisons  
 Extensión abierta

art. mm.  
 14004-00 500x500x42



**Rack cover**  
 Coperchio per cestelli  
 Deckel für Körbe  
 Couvercle à panier  
 Tapa para cestas

art. mm.  
 14011-00 505x505x25



**Open rack**  
 Cestello universale  
 Universal-Korb  
 Panier universel  
 Cesta universal

art. mm.  
 14010-00 500x500x103



**Cutlery rack**  
 Cestello per posate  
 Besteckkorb  
 Panier à couverts  
 Cesta para cubiertos

art. mm.  
 14006-00 500x500x103



**Plates & trays rack**  
 Cestello per piatti e vassoi  
 Tablett- u. Tellerkorb mit Fingern  
 Panier à plateaux et assiettes  
 Cesta para bandejas y platos

art. mm.  
 14008-00 500x500x103

**For 18 flat plates or 9 trays max. 460 mm.**  
 Per 18 piatti piani oppure 9 vassoi max. 460 mm.



**Tray rack, open**  
 Cestello per vassoi, aperto  
 Tablettkorb mit Fingern, offen  
 Panier à plateaux, ouvert  
 Cesta abierto para bandejas

art. mm.  
 14007-00 500x500x103

**For trays over 460 mm. Capacity 9 pcs.**  
 Per vassoi oltre 460 mm. Cap. 9 pz.



**Clip tags, 10-pcs set**  
 Etichette di identificazione, set 10 pz  
 Markierungsklipp, 10 Stk.  
 Clips, set 10 pièces  
 Etiquetas, set 10 piezas

art. mm.  
 14013-00 80x40



**Cutlery holder 8 compartments**  
 Cestello per posate 8 scomparti  
 Besteckkorb, 8 Unterteilungen  
 Panier à couverts 8 compartiments  
 Cesta para cubiertos

art. mm.  
 14015-08 426x206x150

**For 200/250 pcs cutlery. – Per 200/250 posate.**





SS

**Cutlery dispenser**

Porta posate  
Besteckbehälter  
Récipient à couverts  
Contenedor para cubiertos

| art.     | cm.      |
|----------|----------|
| 42587-04 | 26x30x20 |



SS

**Cutlery holder**

Cestello porta posate  
Besteckbehälter  
Récipient à couverts  
Cestillo para cubiertos

| art.     | Ø cm. | h. cm. |
|----------|-------|--------|
| 42586-10 | 10    | 14     |



PE

**Cutlery holder**

Cestello porta posate  
Besteckbehälter  
Récipient à couverts  
Cestillo para cubiertos

| art.     | Ø cm. | h. cm. |
|----------|-------|--------|
| 42586-09 | 9,5   | 13,5   |



PP

**Cutlery dispenser**

Porta posate  
Besteckbehälter  
Récipient à couverts  
Contenedor para cubiertos

| art.     | cm.      |
|----------|----------|
| 42585-06 | 54x33x13 |



PE

**Cutlery dispenser**

Porta posate  
Besteckbehälter  
Récipient à couverts  
Contenedor para cubiertos

| art.     | cm.     | GN  | h. cm. |
|----------|---------|-----|--------|
| 42585-04 | 32,5x53 | 1/1 | 10     |



PP

**Cutlery box lid**

Coperchio per porta posate  
Deckel für Besteckbehälter  
Couvercle pour récipient à couverts  
Tapa para contenedor cubiertos

| art.     | cm.       |
|----------|-----------|
| 42585-00 | 32,5x53x2 |



**Dolly with handle**

Carrello con maniglione  
Transportwagen mit Griff  
Chariot avec poignée  
Carretilla con manillar

| art.     | cm.      | Kg. |
|----------|----------|-----|
| 44023-00 | 54x54x75 | 10  |



**Dolly without handle**

Carrello senza maniglione  
Transportwagen ohne Griff  
Chariot sans poignée  
Carretilla sin manillar

| art.     | cm.   | Kg. |
|----------|-------|-----|
| 44024-00 | 54x54 | 8,5 |



**Dolly, aluminum/ABS**

Carrello, alluminio/ABS  
Transportwagen, Aluminium/ABS  
Chariot, aluminium/ABS  
Carro, aluminio/ABS

| art.     | cm.   |
|----------|-------|
| 44975C50 | 51x51 |

Polypropylene base. – Base in PP.

Polypropylene base. – Base in PP.





SS

**Dolly with handle**  
 Carrello con maniglione  
 Transportwagen mit Griff  
 Chariot avec poignée  
 Carretilla con manillar

art. cm.  
 44025-50 55x55x9

**Removable handle, with drip and drain plug. Load 60 kg.** – Manico estraibile, tappo di scarico. Carico 60 kg.



**Dust cover**  
 Copertura protettiva  
 Schutzhülle  
 Housse de protection  
 Cuberta protectora

art. cm.  
 44009-00 55x55x122



SS

**Trolley 3 levels**  
 Carrello 3 livelli  
 3-stöckiger Wagen  
 Chariot à 3 étages  
 Carro 3 pisos

art. cm.  
 44020-21 100x50x178,5

**Suitable for 24 racks.**  
 Carico verticale per 24 cestelli.



PP

**Multipurpose box**  
 Recipiente  
 Behälter  
 Conteneur multiservice  
 Contenedor

art. cm.  
 44031-04 52x39x12,7  
 44031-05 52x39x17,7

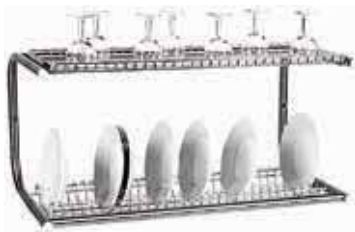

SS

**Wall draining rack**  
 Scolapiatti a muro  
 Wand-Trockengestell  
 Egouttoir au mur  
 Escurridor mural de platos

art. cm.  
 44029-00 87x30x20

**Load/Carico: 70 kg.**



**Wire dish rack**  
 Porta piatti in filo metallo/rilsan  
 Tellergestell  
 Porte-assiettes  
 Porta platos

| art.     | Ø cm. | h. cm. |
|----------|-------|--------|
| 44047-17 | 17    | 30     |
| 44047-19 | 19    | 30     |
| 44047-22 | 22    | 30     |
| 44047-25 | 25    | 30     |
| 44047-28 | 28    | 30     |



SS

**Dish dolly**  
 Carrello portapiatti  
 Teller-Transportwagen  
 Chariot porte-assiettes  
 Carro porta platos

art. cm.  
 44027-00 74x61x81

**Load/Carico max: 240 kg.**



PE

**Adjustable dish dolly**  
 Carrello portapiatti regolabile  
 Teller-Transportwagen, einstellbar  
 Chariot de stockage d'assiettes réglable  
 Carro ajustable para platos

art.  
 49304-06

**With dust cover and 4 dividers. Dishes Ø cm 16-32, capacity 180/400 pcs.** – Con copertura vinilica e 4 divisori. Per piatti Ø cm16-32, capienza 180/400 pz.

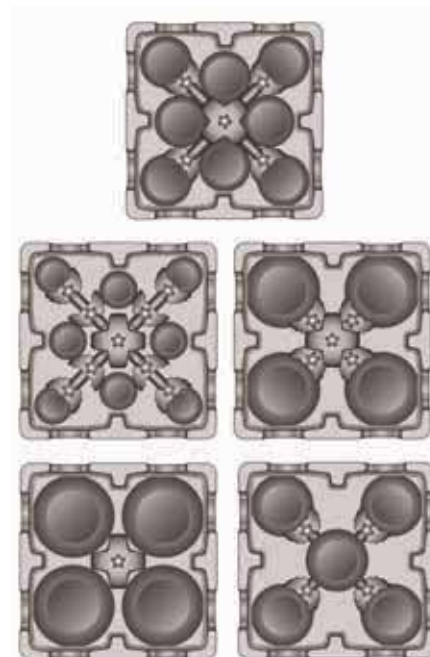

**CROCKERY TRANSPORT BOX**  
CONTENITORE PER IL TRASPORTO DI STOVIGLIE

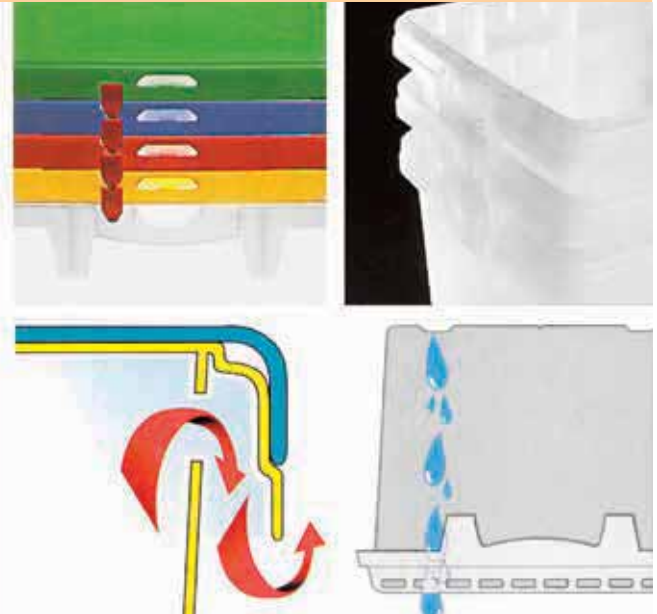

Clear polypropylene construction, full compliance with food contact requirements. A removable tower insert provides total flexibility. Strong, it prevents dish breakage in transport. Dimensions suitable to EURO-pallets. Lids are tightly fitting, hygienic, dish-washer safe. Covers available in different colors, assure easy and quick content identification. Stackable once empty, their strongness provides high loading density once full. Ventilation holes assure constant air circulation. Design studied to enable water flow while washing.

Contenitori in polipropilene trasparente per alimenti. Estremamente resistenti alle sollecitazioni, offrono protezione sicura nel trasporto. Dimensioni adatte a EURO-pallets. Adatti al lavaggio in lavastoviglie, design studiato per consentire il defluire dell'acqua. Coperchi di colore diverso facilitano l'individuazione del contenuto. Impilabili, a pieno la loro robustezza consente un'elevata capacità di sovrapposizione. Fessure di aerazione per un costante ricambio d'aria.



**Storage box**

Contentitore  
Korb  
Panier  
Contenedor

| art.     | cm.        | lt. |
|----------|------------|-----|
| 44040-40 | 40x40x31,5 | 32  |



**Base insert**

Fondo piatto  
Flach-Einsatz  
Plateau double fond  
Base plana

| art.     | cm.   |
|----------|-------|
| 44042-00 | 40x40 |



**Cross insert**

Inserto croce  
Kreuz-Einsatz  
Cloison à croix  
Separador a cruz

| art.     | cm.   |
|----------|-------|
| 44043-00 | 40x40 |



**Cover**

Coperchio  
Deckel  
Couvercle  
Tapa

| art.     | col. |
|----------|------|
| 44041-00 | ○    |
| 44041-01 | ●    |
| 44041-03 | ●    |



**Cover**

Coperchio  
Deckel  
Couvercle  
Tapa

| art.     | col. |
|----------|------|
| 44041-04 | ●    |
| 44041-05 | ●    |



**Tower insert**

Tubo fermapiatti  
Rohr-Einsatz  
Tuyau  
Tubo

| art.     |
|----------|
| 44044-00 |

**SQUARE & ROUND CONTAINERS**  
CONTENITORI QUADRATI & ROTONDI



**Space-saving SQUARE containers.** In transparent anti-breaking material to identify the contents. Graduated measurements: red for US sizes and blue for liters. Resistant handles. Drainage holes. They withstand temperatures between -40°C and 100°C. Lids with hermetic pressure closure and corner tab for easy removal.

**ROUND stackable containers.** Reinforced rims. Drainage holes. They withstand temperatures between -28°C and 65°C. Dishwasher safe. Tight-fitting lids with double barrier and opening flap in the corner. Writing area on the cover to specify date and content.

Contenitori QUADRATI salvaspazio. In materiale infrangibile, trasparente per identificare il contenuto. Misurazioni graduate: rosse per le misure USA e blu per i litri. Impugnature resistenti. Fori di drenaggio. Resistono a temperature comprese fra i -40°C e i 100°C. Coperchi a chiusura ermetica a pressione e linguetta per una rimozione agevole.

Contenitori ROTONDI impilabili. Bordi rinforzati. Fori di drenaggio. Resistono a temperature comprese fra i -28°C e i 65°C. Lavabili in lavastoviglie. I coperchi sono a chiusura ermetica con doppia barriera e linguetta di apertura nell'angolo. Consentono l'indicazione della data e del contenuto in un'apposita area di scrittura.



**Food container, copolyester**

Contenitore per alimenti, copoliestere  
Vorratsdosen, Copoliéster  
Conteneur pour aliments, copolyester  
Contenedor para alimentos, copolyester

| art.     | cm.        | lt. |
|----------|------------|-----|
| 44620-01 | 22x21x7    | 1,9 |
| 44620-02 | 22x21x12   | 3,8 |
| 44620-03 | 22x21x17,5 | 5,7 |
| 44620-04 | 22x21x22   | 7,6 |



**Food container, copolyester**

Contenitore per alimenti, copoliestere  
Vorratsdosen, Copoliéster  
Conteneur pour aliments, copolyester  
Contenedor para alimentos, copolyester

| art.     | cm.        | lt.  |
|----------|------------|------|
| 44620-05 | 29x27x19   | 11,4 |
| 44620-06 | 29x27x30   | 17,0 |
| 44620-07 | 29x27x36,5 | 20,8 |



PE

**Square lid**

Coperchio quadrato  
Deckel, viereckig  
Couvercle carré  
Tapa cuadrada

| art.     | cm.   |
|----------|-------|
| 44620-14 | 22x21 |
| 44620-17 | 29x27 |



PP

**Food container**

Contenitore per alimenti  
Vorratsdosen  
Conteneur pour aliments  
Contenedor para alimentos

| art.     | Ø cm. | h. cm. | lt.  |
|----------|-------|--------|------|
| 44625-03 | 25    | 19,5   | 5,7  |
| 44625-04 | 25    | 27,0   | 7,6  |
| 44625-05 | 33    | 20,5   | 11,4 |
| 44625-06 | 33    | 30,0   | 17,0 |



PP

**Food container**

Contenitore per alimenti  
Vorratsdosen  
Conteneur pour aliments  
Contenedor para alimentos

| art.      | Ø cm. | h. cm. | lt.  |
|-----------|-------|--------|------|
| 44625-07  | 33    | 35,5   | 20,8 |
| 44625-08* | 33    | 35,5   | 20,8 |

\*With handle. – Con manico.



PE

**Round lid**

Coperchio rotondo  
Deckel, rund  
Couvercle rond  
Tapa redonda

| art.     | Ø cm. | col. |
|----------|-------|------|
| 44625-26 | 25    | ●    |
| 44625-34 | 33    | ●    |





PC

**Food container**

Contentore per alimenti  
Nahrungsmittel-Behälter  
Conteneur pour aliments  
Contenedor para alimentos

| art.     | cm.        | lt.  |
|----------|------------|------|
| 49384-03 | 45,7x30x23 | 19,0 |
| 49384-04 | 45,7x66x9  | 19,0 |
| 49384-05 | 45,7x66x15 | 32,3 |
| 49384-06 | 45,7x66x23 | 47,0 |
| 49384-07 | 45,7x66x38 | 81,5 |



PC

**Drain tray**

Vasca di drenaggio  
Abtropf-Behälter  
Conteneur perforé  
Contenedor para colar

| art.     | cm.        |
|----------|------------|
| 49384-11 | 45,7x66x12 |



PC

**Lid**

Coperchio  
Deckel  
Couvercle  
Tapa

| art.     | cm.     |
|----------|---------|
| 49384-14 | 45,7x30 |
| 49384-15 | 45,7x66 |



PP

**Food container**

Contentore per alimenti  
Nahrungsmittel-Behälter  
Conteneur pour aliments  
Contenedor para alimentos

| art.     | cm.        | lt.  |
|----------|------------|------|
| 49382-10 | 30x38x21,5 | 10,0 |
| 49382-23 | 60x49x43   | 23,5 |
| 49382-47 | 60x29x43   | 47,0 |



PP

**Storage container**

Carrello per derrate alimentari  
Fahrbares Nahrungsmittelbehälter  
Chariot mobile de stockage  
Contenedor para hortalizas

| art.     | cm.          | lt.  |
|----------|--------------|------|
| 49381-01 | 74x33,5x71   | 79,0 |
| 49381-02 | 75x39,5x71   | 97,5 |
| 49381-03 | 75,5x45,5x71 | 116  |



PE

**Container, round**

Contentore tondo  
Behälter, rund  
Conteneur, rond  
Contenedor redondo

| art.     | Ø cm. | h. cm. | lt.   |
|----------|-------|--------|-------|
| 49373-01 | 39,7  | 43,5   | 37,9  |
| 49373-02 | 49,5  | 58,1   | 75,7  |
| 49373-03 | 55,9  | 69,2   | 121,1 |
| 49373-04 | 67,3  | 83,8   | 208,2 |



PE

**Lid, round**

Coperchio tondo  
Deckel, rund  
Couvercle, rond  
Tapa redonda

| art.     | Ø cm. | h. cm. |
|----------|-------|--------|
| 49373-11 | 40,6  | 2,5    |
| 49373-12 | 50,5  | 3,2    |
| 49373-13 | 56,5  | 3,5    |
| 49373-14 | 67,9  | 5,1    |



PE

**Dolly**

Supporto mobile  
Wagen  
Chariot  
Soporte móvil

| art.     | Ø cm. | h. cm. |
|----------|-------|--------|
| 49373-90 | 46,4  | 17     |

**Load/Carico: 113,4 kg.**



SS

**Sink trolley**

Carrello vasca  
Obst/Gemüsewaschwagen  
Chariot à évier  
Carro-cuba lavado verduras

| art.     | cm.      | lt. |
|----------|----------|-----|
| 44028-19 | 80x60x75 | 190 |

**Tub with tap, brushed finish. Stamped bottom watertight, without edges.** – Vasca con rubinetto, finitura spazzolata. Fondo stampato a tenuta stagna, privo di spigoli.



**Bread basket**  
Cesta pane  
Brot-Korb  
Corbeille à pain  
Cesta pan

| art.     | cm.      | lt. |
|----------|----------|-----|
| 44982-04 | 57x36x34 | 40  |
| 44982-06 | 66x45x35 | 60  |
| 44982-10 | 78x52x40 | 100 |



**Space saving box with cover**  
Contentore con coperchio  
Behälter mit Deckel  
Récipient avec couvercle  
Contenedor con tapa

| art.     | cm.      |
|----------|----------|
| 44033-23 | 66x45x23 |
| 44033-38 | 67x46x38 |



**Gastronorm basket**  
Cesto gastronorm  
Gastronorm-Korb  
Panier gastronorme  
Cesta gastronorm

| art.     | cm.        |
|----------|------------|
| 44034-11 | 59x39x19,5 |

## STACKABLE CONTAINERS CONTENITORI SOVRAPPONIBILI



**Stackable containers, external dimensions 600x400 mm and 400x300 mm, they perfectly fit to 800x1200 mm EUR pallets and to 1000x1200 mm. Available in different heights and versions. High density polyethylene HDPE. A thermoplastic that offers excellent impact resistance at low temperatures (from -30°C to +70°C).**

Contenitori sovrapponibili con dimensioni esterne di mm 600x400 e 400x300 perfettamente pallettizzabili su pallet EUR mm 800x1200 e 1000x1200. Disponibili in diverse altezze e versioni. Polietilene alta densità HDPE. Uno dei materiali termoplastici più dotato di resistenza all'impatto con basse temperature (da -30°C a +70°C).



**Container**  
Contentitore  
Behälter  
Conteneur  
Contenedor

| art.     | cm.      | lt. |
|----------|----------|-----|
| 44511E21 | 60x40x10 | 21  |
| 44511E63 | 60x40x32 | 63  |
| 44511E90 | 60x40x45 | 90  |

**Solid bottom and sides. – Fondo e pareti chiuse.**



**Container**  
Contentitore  
Behälter  
Conteneur  
Contenedor

| art.     | cm.      | lt. |
|----------|----------|-----|
| 44512E12 | 60x40x7  | 12  |
| 44512E21 | 60x40x10 | 21  |

**Solid bottom and perforated sides.**  
Fondo chiuso e pareti forate.



**Container**  
Contentitore  
Behälter  
Conteneur  
Contenedor

| art.     | cm.      | lt. |
|----------|----------|-----|
| 44513E12 | 60x40x7  | 12  |
| 44513E21 | 60x40x10 | 21  |

**Perforated bottom and sides.**  
Fondo e pareti forate.





PP

**Lid**  
Coperchio  
Deckel  
Couvercle

**Tapa**

| art.     | cm.     |
|----------|---------|
| 41763-00 | 60x40x2 |



PP

**Lid**  
Coperchio  
Deckel  
Couvercle

**Tapa**

| art.     | cm.     |
|----------|---------|
| 41763-30 | 40x30x2 |



**Container**  
Contentitore  
Behälter  
Conteneur

**Contenedor**

| art.     | cm.      | lt. |
|----------|----------|-----|
| 44521E10 | 40x30x12 | 10  |

**Solid bottom and sides. – Fondo e pareti chiuse.**



**Container**  
Contentitore  
Behälter  
Conteneur  
Contenedor

| art.     | cm.      | lt. |
|----------|----------|-----|
| 44521-16 | 40x30x17 | 16  |
| 44521-21 | 40x30x22 | 21  |
| 44521-31 | 40x30x32 | 31  |

**Solid bottom and sides. – Fondo e pareti chiuse.**



**Container**  
Contentitore  
Behälter  
Conteneur  
Contenedor

| art.     | cm.      | lt. |
|----------|----------|-----|
| 44511-27 | 60x40x15 | 27  |
| 44511-34 | 60x40x17 | 34  |
| 44511-38 | 60x40x20 | 38  |
| 44511-42 | 60x40x22 | 42  |
| 44511-63 | 60x40x32 | 63  |
| 44511-90 | 60x40x45 | 90  |

**Solid bottom and sides. – Fondo e pareti chiuse.**



**Container**  
Contentitore  
Behälter  
Conteneur  
Contenedor

| art.     | cm.      | lt. |
|----------|----------|-----|
| 44522E10 | 40x30x12 | 10  |

**Solid bottom and perforated sides.  
Fondo chiuso e pareti forate.**



**Container**  
Contentitore  
Behälter  
Conteneur  
Contenedor

| art.     | cm.      | lt. |
|----------|----------|-----|
| 44522-16 | 40x30x17 | 16  |
| 44522-21 | 40x30x22 | 21  |
| 44522-31 | 40x30x32 | 31  |

**Solid bottom and perforated sides.  
Fondo chiuso e pareti forate.**



**Container**  
Contentitore  
Behälter  
Conteneur  
Contenedor

| art.     | cm.      | lt. |
|----------|----------|-----|
| 44512-34 | 60x40x17 | 34  |
| 44512-42 | 60x40x22 | 42  |
| 44512-63 | 60x40x32 | 63  |
| 44512-90 | 60x40x45 | 90  |

**Solid bottom and perforated sides.  
Fondo chiuso e pareti forate.**



**Container**  
Contentitore  
Behälter  
Conteneur  
Contenedor

| art.     | cm.      | lt. |
|----------|----------|-----|
| 44513-34 | 60x40x17 | 34  |
| 44513-38 | 60x40x20 | 38  |
| 44513-54 | 60x40x29 | 54  |
| 44513-63 | 60x40x32 | 63  |
| 44513-90 | 60x40x45 | 90  |

**Perforated bottom and sides.  
Fondo e pareti forate.**

## POLYPROPYLENE CONTAINERS CONTENITORI POLIPROPILENE



They do not hand over odours or flavours to foods. Easy to wash and disinfect after use. Light and free of protrusions and sharp edges. Resistant, hygienic, economic, 100% recyclable, suitable for industrial washing and disinfection with detergents and disinfectants, hot water, and wet vapour up to 110°C (HACCP System). Suitable to protect food thermal stresses.

Non cedono odori e sapori agli alimenti, facilmente lavabili e sanificabili. Leggeri e privi di sporgenze e spigoli vivi. Resistenti, igienici, ecologici e riciclabili al 100%. Compatibili al lavaggio e alla disinfezione industriale con detergenti e disinfectanti, acqua calda e vapore umido fino a 110°C (HAACCP System). Idonei a proteggere gli alimenti da sollecitazioni termiche.



### Insulated container POWERBOX

Contentitore isotermico  
Thermobehälter  
Conteneur isotherme  
Contenedor isotérmico

| art.     | cm.          | lt. |
|----------|--------------|-----|
| 44961-05 | 64,5x40x31,5 | 45  |



### Insulated container UNIVERSAL PN

Contentitore isotermico  
Thermobehälter  
Conteneur isotherme  
Contenedor isotérmico

| art.     | cm.        | lt.  |
|----------|------------|------|
| 44986-12 | 61x43x20   | 24,0 |
| 44986-17 | 61x43x25   | 33,8 |
| 44986-21 | 61x43x29,5 | 42,8 |
| 44986-28 | 61x43x36,5 | 56,7 |



### Insulated container GN 1/2

Contentitore isotermico  
Thermobehälter  
Conteneur isotherme  
Contenedor isotérmico

| art.     | cm.          | lt.  |
|----------|--------------|------|
| 44972-20 | 41,5x32x28,5 | 20,3 |
| 44972-25 | 41,5x32x32   | 21,6 |
| 44972-33 | 41,5x32x40   | 31,2 |



### Insulated container GN 1/1

Contentitore isotermico  
Thermobehälter  
Conteneur isotherme  
Contenedor isotérmico

| art.     | cm.        | lt.  |
|----------|------------|------|
| 44970-10 | 60x40x17   | 20,2 |
| 44970-15 | 60x40x23   | 31,2 |
| 44970-20 | 60x40x27   | 38,6 |
| 44970-34 | 60x40x34,5 | 52,3 |



### OPTIONAL 44970 - Sling & dolly

Imbragature e carrello  
Gurt und Wagen  
Sangle et chariot  
Correa y carro

| art.     | cm.   |
|----------|-------|
| 44987C62 | 62x42 |
| 44973-10 | sling |
| 44973-20 | sling |



### Insulated container PLUS GN 1/1

Contentitore isotermico  
Thermobehälter  
Conteneur isotherme  
Contenedor isotérmico

| art.     | cm.        | lt.  |
|----------|------------|------|
| 44978-10 | 68x44,5X20 | 24,9 |
| 44978-20 | 68x44,5X30 | 45,6 |



### Insulated pastry container

Contentitore isotermico pasticceria  
Konditorei-Thermobehälter  
Conteneur isotherme à pâtisserie  
Contenedor isotérmico para pastelería

| art.     | cm.          | lt.  |
|----------|--------------|------|
| 44974-21 | 68,5x48,5x27 | 55,8 |
| 44974-27 | 68,5x48,5x33 | 71,7 |
| 44974-31 | 68,5x48,5x37 | 82,3 |



### Insulated container HANDTOP

Contentitore isotermico  
Thermobehälter  
Conteneur isotherme  
Contenedor isotérmico

| art.     | cm.          | lt. |
|----------|--------------|-----|
| 44961-06 | 71,5x40x31,5 | 45  |

**Incorporated ergonomic handles. For Gastronorm 1/1 or submultiples. – Maniglie ergonomiche incorporate. Trasporta Gastronorm da 1/1 o sottomultipli.**



### Insulated container TROLLEYBOX

Contentitore isotermico  
Thermobehälter  
Conteneur isotherme  
Contenedor isotérmico

| art.     | cm.      | lt. |
|----------|----------|-----|
| 44961-04 | 42x42x60 | 60  |



**Insulated container BOXSHOP**

Contentitore isotermico  
Thermobehälter  
Conteneur isotherme  
Contenedor isotérmico

| art.     | cm.        | lt.  |
|----------|------------|------|
| 44961-02 | 41,5x32x40 | 31,2 |



**Insulated container PIZZABOX**

Contentitore isotermico  
Thermobehälter  
Conteneur isotherme  
Contenedor isotérmico

| art.     | cm.        | lt. |
|----------|------------|-----|
| 44961-03 | 42x42x34,5 | 36  |

**With steam release system.**  
Con sistema di rilascio del vapore.



**Insulated container POPTER GN 1/1**

Contentitore isotermico  
Thermobehälter  
Conteneur isotherme  
Contenedor isotérmico

| art.     | cm.      | lt. |
|----------|----------|-----|
| 44987-11 | 65x50x61 | 83  |

**For GN 1/1 or submultiples. 12 guides.**  
Per GN 1/1 o sottomultipli. 12 guide.



**Insulated container PORTER MAXI**

Contentitore isotermico  
Thermobehälter  
Conteneur isotherme  
Contenedor isotérmico

| art.     | cm.      | lt. |
|----------|----------|-----|
| 44987-60 | 72x60x63 | 128 |

**Guides/Guide: 9**



**Insulated container GN CRYSTAL**

Contentitore isotermico  
Thermobehälter  
Conteneur isotherme  
Contenedor isotérmico

| art.     | cm.      | lt.  |
|----------|----------|------|
| 44968-00 | 60x40x30 | 45,4 |

**Inside crystallized and therefore perfectly smooth, rigid and waterproof.**  
Interno cristallizzato perfettamente liscio, rigido e impermeabile.



**Dolly, aluminum/ABS**

Carrello, alluminio/ABS  
Fahrgestell, Aluminium/ABS  
Chariot, aluminium/ABS  
Carro, aluminio/ABS

| art.     | cm.       | for/per  |
|----------|-----------|----------|
| 44975C50 | 58,5x58,5 | 44975-50 |
| 44987C11 | 68x52     | 44987-11 |
| 44987C60 | 75x61     | 44987-60 |
| 44987C62 | 62x42     | 44968-00 |



**Eutectic pad**

Accumulatore di freddo  
Kühlakku  
Cartouche eutectique  
Placa eutéctica

| art.     | cm.         | GN  |
|----------|-------------|-----|
| 44979-04 | 32,5x26,5x3 | 1/2 |
| 44979-05 | 53x32,5x3   | 1/1 |
| 44979-06 | 60x40x3     | -   |

**0/-21°C.**



**Heat accumulator**

Accumulatore di caldo  
Wärmespeicher  
Accumulateur de chaleur  
Acumulador de calor

| art.     | cm.       | GN  |
|----------|-----------|-----|
| 44979-02 | 53x32,5x3 | 1/1 |

**0/+85°C.**



**Insulated box**

Box isotermico  
Thermobehälter  
Conteneur isotherme  
Contenedor individual isotérmico

| art.     | cm.      |
|----------|----------|
| 44976-04 | 44x38x12 |

**3 sections for dishes ø 12 h 6 cm or 16x16 cm.**  
3 vani per piatti ø 12 h 6 cm o 16x16 cm.





**Insulated box DOMUS**

Box isothermico  
Thermobehälter  
Conteneur isotherme  
Contenedor individual isotérmico

art. cm.  
44976-02 42,5x26,5x16,5

**2 sections for dishes 18x18 cm.**  
2 vani per piatti 18x18 cm.



**Insulated box MONOKING**

Box isothermico  
Thermobehälter  
Conteneur isotherme  
Contenedor individual isotérmico

art. cm.  
44976-01 42,5x35x16

**2 insulated sections for dishes size 18x18 cm.**  
2 vani coibentati per piatti 18x18 cm.



**Insulated box THERMOKING**

Box isothermico  
Thermobehälter  
Conteneur isotherme  
Contenedor individual isotérmico

art. cm.  
44976-03 47x37x18,5

**Release latch lid. Usefull height 11,5 cm.**  
Coperchio a incastro. Altezza utile 11,5 cm.

**MODULAR SYSTEM**  
SISTEMA MODULARE



**Modular system, the base and lid are the same element and due to the extender insert it is possible to increase capacity. Equipped with rotation system that allows steam to escape.**

**Sistema modulare, base e coperchio sono lo stesso elemento e grazie all'inserto estensore è possibile aumentare la capacità. Provvisto di sistema rotabile, per la fuoriuscita del vapore.**



**Base and lid**

Base e coperchio  
Basis und Abdeckung  
Base et couvercle  
Base y tapa

art. cm. ext.  
44975-35 41x41x7,5  
44975-50 57x57x9,5



**Extender**

Estensore  
Aufsatz  
Réhausse  
Extensión

art. cm. ext.  
44975H35 41x41x7,5  
44975H50 57x57x9,5





SS

**Insulated container**  
Contentitore isotermico  
Thermobehälter  
Conteneur isotherme  
Contenedor isotérmico

| art.     | Ø cm. | h. cm. | lt. |
|----------|-------|--------|-----|
| 44505-10 | 30    | 22,5   | 10  |
| 44505-15 | 36    | 21,5   | 15  |
| 44505-20 | 36    | 28,5   | 20  |
| 44505-25 | 36    | 35,0   | 25  |



SS

**Insulated container**  
Contentitore isotermico  
Thermobehälter  
Conteneur isotherme  
Contenedor isotérmico

| art.     | Ø cm. | h. cm. | lt. |
|----------|-------|--------|-----|
| 44506-09 | 30    | 34     | 9   |

**Incl. cleaning brush and labels Milk, Coffee and Tea in 5 languages.** – Incl. scovolino, etichette Latte, Caffè e Tè in 5 lingue.



SS

**Food container**  
Pietanziera  
Speisenbehälter  
Porte-manger  
Contenedor comida

| art.     | Ø cm. | h. cm. |
|----------|-------|--------|
| 44977-12 | 12    | 6      |



**Insulated container GN 1/1**  
Contentitore isotermico GN 1/1  
Thermobehälter GN 1/1  
Conteneur isotherme GN 1/1  
Contenedor isotérmico GN 1/1

| art.     | cm.      | lt.  |
|----------|----------|------|
| 44932-15 | 61x41x25 | 24,6 |
| 44932-20 | 61x41x30 | 31,1 |



**Insulated container GN 1/1**  
Contentitore isotermico GN 1/1  
Thermobehälter GN 1/1  
Conteneur isotherme GN 1/1  
Contenedor isotérmico GN 1/1

| art.     | cm.      | lt. |
|----------|----------|-----|
| 44934-30 | 44x64x48 | 63  |



**Insulated beverage dispenser**  
Distributore di bevande isotermico  
Isolierte Getränkebehälter  
Conteneur isotherme avec robinet  
Contenedor isotérmico con grifo

| art.     | cm.      | lt. |
|----------|----------|-----|
| 44930-10 | 24x43x43 | 10  |
| 44930-20 | 30x46x46 | 20  |



PP

**Ice cart**  
Carrello porta ghiaccio  
Eiswagen  
Chariot à glace  
Carro hielo

| art.     | cm.      |
|----------|----------|
| 44936-57 | 72x57x85 |

**Load/Carico: 57 kg.**



PC

**Ice scoop with holder**  
Pala ghiaccio con supporto  
Eisschaufel mit Träger  
Pelle à glace avec support  
Librador hielo con soporte

| art.     | cm.          | lt. |
|----------|--------------|-----|
| 44936-02 | 30,7x20,3x19 | 2   |



PC

**Ice bucket**  
Secchio ghiaccio  
Eiseimer  
Seau à glace  
Cubo hielo

| art.     | cm.      | lt.  |
|----------|----------|------|
| 44936-20 | 34x31x45 | 20,8 |

## JACKSTACK

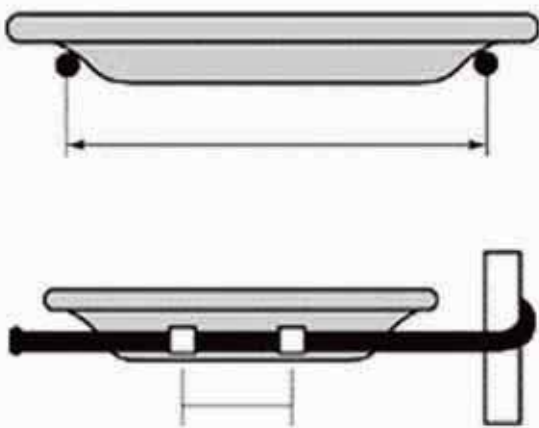

Welded steel construction. Black electrostatic powder coating. Quick set assembly in minutes. Quick-change to any plate size (max ø cm 30, kg 3 each). Length of plate support 17 cm, spacing 5 cm.

Struttura in acciaio saldato. Rivestimento nero elettrostatico. Assemblaggio veloce. Adattabile ad ogni misura di piatto (ø max cm 30, kg 3). Lunghezza bracci 17 cm, distanza 5 cm.



**Mobile plate rack**  
Carrello porta piatti  
Fahrbares Tellergerüst  
Chariot porte-assiettes mobile  
Carrito para almacenaje de platos

art. cm.  
44830-99 60x60X179

For pcs/Per pz 104

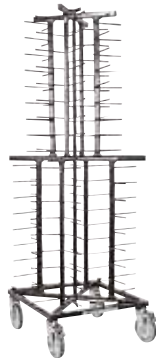

**Mobile plate rack**  
Carrello porta piatti  
Fahrbares Tellergerüst  
Chariot porte-assiettes mobile  
Carrito para almacenaje de platos

art. cm.  
44830-72 60x60X180

For pcs/Per pz 72



**Mobile plate rack**  
Carrello porta piatti  
Fahrbares Tellergerüst  
Chariot porte-assiettes mobile  
Carrito para almacenaje de platos

art. cm.  
44830-52 60x60x103

For pcs/Per pz 52



**Swivelling table top rack**  
Porta piatti rotante  
Drehbares Tischgerüst  
Porte-assiettes de table pivotant  
Soporte para almacenaje de platos

art. cm.  
44831-52 48x48x89

For pcs/Per pz 52



**Zippered plastic cover**  
Copertura in plastica  
Plastik Schutzhülle  
Housse en plastique  
Cubrecarrito, plástico

art. for/per  
44832-99 44830-72/44830-99



**Thermo cover**  
Copertura termica  
Thermo-Hülle  
Thermo-housse  
Cubrecarrito, térmico

art. for/per  
44833-99 44830-72/44830-99





**Thermic hot box**

Box termico  
Speisen-Kaste  
Caisson thermique  
Cajón térmico

art. cm. W  
44094-00 38x40,5x51,2 500

**Stainless steel box with double insulated wall. Analogic thermostat 30-90°C.**  
Box in acciaio inox a doppia parete coibentata. Termostato analogico 30-90°C.



**Refrigerated box**

Box refrigerato  
Speisen-Kaste  
Caisson réfrigéré  
Cajón refrigerado

art. cm.  
44094R00 38x40,5x51

**Stainless steel box with double insulated wall with chilling pack -32°C.**  
Box in acciaio inox a doppia parete coibentata. Refrigerazione a mezzo di una piastra eutettica -32°C.



**Table with hot box**

Tavolino con box termico  
Tisch mit Hot Box  
Table avec hot box  
Carrito con hot box

art. Ø cm. h. cm. W  
44094-02 90/54,6 77 500

**Table with fold down flaps. – Tavolo con flaps pieghevoli.**



**Table with hot box**

Tavolino con box termico  
Tisch mit Hot Box  
Table avec hot box  
Carrito con hot box

art. Ø cm. h. cm. W  
44094-04 90/54,6 78,6 500

**Table with fold down flaps. With capsizable top for stacking when not in use.**  
Tavolo con flaps pieghevoli. Ribaltabile e impilabile quando non in uso.



**Table with hot box**

Tavolino con box termico  
Tisch mit Hot Box  
Table avec hot box  
Carrito con hot box

art. Ø cm. h. cm. W  
44094-06 90/73 76 500

**Table with fold down flaps. Foldable for saving space when not in use. – Tavolo con flaps pieghevoli. Pieghevole per ridurre l'ingombro quando non in uso.**



**Fast food tray**

Vassoio fast food  
Servierplatte, Fast Food  
Plateau fast food  
Bandeja fast food

art. cm.  
41860-36 27x36,5  
41860-43 30,7x43,5  
41860-47 35,5x47



PP

**Fast food tray**  
Vassoio fast food  
Serviertablett, Fast Food  
Plateau fast food  
Bandeja fast food

| art.     | cm.     |
|----------|---------|
| 41861-44 | 30,7x44 |



NEW

PP

**Gastronorm tray**  
Vassoio Gastronorm  
Serviertablett, Gastronorm  
Plateau Gastronorm  
Bandeja Gastronorm

| art.     | cm.         | col. |
|----------|-------------|------|
| 41862B11 | 53x32,5x1,6 | ●    |
| 41862C11 | 53x32,5x1,6 | ●    |
| 41862G11 | 53x32,5x1,6 | ●    |



NEW

PP

**Euronorm tray**  
Vassoio Euronorm  
Serviertablett, Euronorm  
Plateau Euronorm  
Bandeja Euronorm

| art.     | cm.       | col. |
|----------|-----------|------|
| 41862B53 | 53x37x1,6 | ●    |
| 41862C53 | 53x37x1,6 | ●    |
| 41862G53 | 53x37x1,6 | ●    |



NEW

SS

**Universal tray collector trolley**  
Carrello ritiro vassoi universale  
Tablettabräumwagen Universal  
Chariot débarrassage plateaux universel  
Carro porta bandeja universal

| art.     | cm.       |
|----------|-----------|
| 44803-10 | 47x55x153 |
| 44803-20 | 88x55x153 |

**12 cm between shelves. 4 swivel wheels 100 mm. Chrome-plated steel thread supports 6 mm.**  
Distanza fra piani 12 cm. 4 ruote girevoli 100 mm. Supporti in filetto acciaio cromato 6 mm.



NEW

SS

**Universal tray collector trolley**  
Carrello ritiro vassoi universale  
Tablettwagen Universal  
Chariot débarrassage plateaux universel  
Carro porta bandeja universal

| art.     | cm.        |
|----------|------------|
| 44803-30 | 129x55x153 |

**They can hold trays in different sizes (width ranging from 300 to 370 mm) including Euronorm and Gastronorm.** – Possono accogliere vassoi di varia misura (larghezza tra 300 e 370 mm) inclusi Euronorm e Gastronorm.



PP

**Disposable covers, 200 pcs**  
Coperture monouso, 200 pezzi  
Einweg-Schutzhüllen, 200 Stk.  
Housses usage unique, 200 pcs  
Cubreacarritos desechables, 200 pz

| art.     | for/per | h. cm. |
|----------|---------|--------|
| 42512-91 | GN 1/1  | 180    |
| 42512-92 | GN 2/1  | 180    |
|          | 60x40   | 180    |



SS

**Roll holder**  
Porta rotolo  
Rollenhalter  
Dérouleur mural  
Portarollos

| art.     | cm.      |
|----------|----------|
| 42512-90 | 90x23x19 |



SS

**Utility rack GN 2/1**  
Carrello GN 2/1  
2/1 GN-Behälterwagen  
Chariot GN 2/1  
Carro GN 2/1

| art.     | cm.         |
|----------|-------------|
| 44807-28 | 60x70x153,5 |

**Welded structure, 28 rails, 4 wheels, 2 with brakes.** – Struttura saldata, 28 guide, 4 ruote girevoli di cui 2 con freno.



SS

**Utility rack GN 2/1**  
Carrello GN 2/1  
2/1 GN-Behälterwagen  
Chariot GN 2/1  
Carro GN 2/1

| art.     | cm.       |
|----------|-----------|
| 44807-36 | 73x62x171 |

**To be assembled, 18 rails, accomodates GN pans height 65 mm. Load max 300 kg.** – Fornito smontato, 18 guide, accoglie GN di h. 65 mm. Carico max 300 kg.



SS

**Utility rack GN 1/1**

Carrello GN 1/1  
1/1 GN-Behälterwagen  
Chariot GN 1/1  
Carro GN 1/1

art. cm.  
44807-18 38x62x164

**To be assembled, 18 rails, accomodates GN pans height 65 mm. Load max 150 kg.**

Fornito smontato, 18 guide, accoglie GN di h. 65 mm. Carico max 150 kg.



SS

**Utility rack GN 1/1**

Carrello GN 1/1  
1/1 GN-Behälterwagen  
Chariot GN 1/1  
Carro GN 1/1

art. cm.  
44801-09 38x62x94,5

**To be assembled, 9 rails, accomodates GN pans height 65 mm. Load max 75 kg.**

Fornito smontato, 9 guide, accoglie GN di h. 65 mm. Carico max 75 kg.



SS

**Baking sheet trolley**

Carrello porta teglie  
Backbleche-Wagen  
Chariot pour plaques  
Carro porta placas

art. cm.  
44826-00 52x72x85

**Pitch 7,5 cm. For 60x40 cm trays. S/steel top. Swivel castors ø 9.5 cm, 2 with brakes. – Passo 7,5 cm. Per teglie cm 60x40. Piano superiore inox. Ruote piroettanti ø cm 9,5 di cui 2 con freno.**



SS

**Serving trolley**

Carrello di servizio  
Mehrzweckwagen  
Chariot de service  
Carrito para desocupar

art. cm.  
44819-02 91x59x93

**To be assembled, 4 swivel castors, 2 with brakes. Load max 80 kg. – Fornito smontato, 4 ruote girevoli di cui 2 con freno. Carico max 80 kg.**



SS

**Serving trolley**

Carrello di servizio  
Mehrzweckwagen  
Chariot de service  
Carrito para desocupar

art. cm.  
44819-03 91x59x93

**To be assembled, 4 swivel castors, 2 with brakes. Load max 120 kg. – Fornito smontato, 4 ruote girevoli di cui 2 con freno. Carico max 120 kg.**



SS

**Serving trolley**

Carrello di servizio  
Mehrzweckwagen  
Chariot de service  
Carrito para desocupar

art. cm.  
44820-80 80x50x93,5  
44820-99 100x50x93,5

**To be assembled, 4 swivel castors, 2 with brakes. Max load per shelf kg 30. – Fornito smontato, 4 ruote girevoli di cui 2 con freno. Portata max. per ripiano kg 30.**



SS

**Serving trolley**

Carrello di servizio  
Mehrzweckwagen  
Chariot de service  
Carrito para desocupar

art. cm.  
44822-80 80x50x93,5  
44822-99 100x50x93,5

**To be assembled, 4 swivel castors, 2 with brakes. Max load per shelf kg 30. – Fornito smontato, 4 ruote girevoli di cui 2 con freno. Portata max. per ripiano kg 30.**



PP

**Serving trolley**

Carrello di servizio  
Mehrzweckwagen  
Chariot de service  
Carrito para desocupar

art. cm.  
44030-03 42x71x90



PP

**Bins and containers**

Cesti e contenitori  
Kasten und Körbe  
Récipients et containers  
Cubos y contenedores

art. cm.  
44031-04 52x39x12,7  
44031-05 52x39x17,7



PE

**Container**  
 Contenitore  
 Kaste  
 Réipient  
 Contenedor

|          |              |
|----------|--------------|
| art.     | cm.          |
| 44031-01 | 33,7x23x56   |
| 44031-02 | 33,7x23x18,7 |



PP

**Serving trolley**  
 Carrello di servizio  
 Mehrzweckwagen  
 Chariot de service  
 Carrito para desocupar

|          |          |
|----------|----------|
| art.     | cm.      |
| 49995-04 | 97x51x99 |

**Load max 135 kg (45 kg per shelf).**  
 Carico max 135 kg (45 kg per ripiano).



SS

**Minibar restocking cart**  
 Carrello rifornimento frigobar  
 Wagen für Minibar-Versorgung  
 Chariot mini-bar  
 Carro servicio minibar

|          |           |
|----------|-----------|
| art.     | cm.       |
| 44095-30 | 73x47x102 |

**3 PVC boxes with anti-tip cage for 40 bottles ø 6,5 cm max. Castor wheels ø 12,5 cm, 2 with brakes.** – Con 3 cassette in PVC, dotate di gabbia antiribaltamento per 40 bottiglie ø cm 6,5 max. Ruote piroettanti ø cm 12,5 di cui 2 con freno.



**Minibar restocking cart**  
 Carrello rifornimento frigobar  
 Wagen für Minibar-Versorgung  
 Chariot mini-bar  
 Carro servicio minibar

|          |            |
|----------|------------|
| art.     | cm.        |
| 44095-32 | 100x62x119 |

**Side handle. Key lock. 2 fixed and 2 swivel casters ø 16 cm 2 with brakes.** – Maniglia laterale di spinta. Chiusura con chiave. Ruote ø cm 16, di cui due fisse e due piroettanti con freno.



SS

**Utility rack GN 2/1**  
 Carrello GN 2/1  
 2/1 GN-Behälterwagen  
 Chariot GN 2/1  
 Carro GN 2/1

|          |            |
|----------|------------|
| art.     | cm.        |
| 44801-18 | 73x62x94,5 |

**To be assembled, 9 rails, accomodates GN pans height 65 mm. Load max 150 kg.**  
 Fornito smontato, 9 guide, accoglie GN di h. 65 mm. Carico max 150 kg.



SS

**Baking sheet trolley**  
 Carrello porta teglie  
 Backbleche-Wagen  
 Chariot pour plaques  
 Carro porta placas

|          |           |
|----------|-----------|
| art.     | cm.       |
| 44826-20 | 69x49x187 |

**20 rails for baking sheets cm 60x40, height clearance 8 cm. Load max 100 kg.**  
 20 guide per teglie cm 60x40, distanza guide 8 cm. Carico max 100 kg.



**Baking sheet trolley, galvanized steel**  
 Carrello porta teglie, zincato  
 Backbleche-Wagen, verzinkt  
 Chariot pour plaques, galvanisé  
 Carro porta placas, galvanizado

|          |           |
|----------|-----------|
| art.     | cm.       |
| 44825-20 | 51x50x170 |

**20 rails, height clearance 8 cm. Load max. 80 kg.**  
 20 guide, distanza guide 8 cm. Carico max 80 kg.



**Baking sheet trolley, galvanized steel**  
 Carrello porta teglie, zincato  
 Backbleche-Wagen, verzinkt  
 Chariot pour plaques, galvanisé  
 Carro porta placas, galvanizado

|          |           |
|----------|-----------|
| art.     | cm.       |
| 44825-40 | 51x75x170 |

**40 rails, height clearance 8 cm. Load max 160 kg.**  
 40 guide, distanza guide 8 cm. Carico max 160 kg.



**SS**

**Dolly for cases**

Carrello porta cassette  
Plattformwagen  
Chariot à caisses  
Carretilla de transporte

art. cm.  
44026-60 65x45x12

**Load max 50 kg. – Carico max 50 kg.**



**PE**

**Platform cart**

Carrello trasporto materiali  
Plattformwagen  
Chariot de transport  
Plataforma móvil

art. cm.  
49378-00 82,6x52x98,7

**Three position handle ensures optimum handling whatever the load. Non slip deck, 2 swivel and 2 rigid castors. Load 181 kg. – Maniglia regolabile in 3 posizioni. Superficie antiscivolo. 2 ruote fisse, 2 pivotanti. Carico 181 kg.**



**PP**

**Trolley, convertible**

Carrello convertibile  
Plattformwagen, umwandelbar  
Chariot convertible  
Carretilla convertible

art. cm.  
49379-00 56x53x43,5

**Four non-marking casters (two rear locking), 2 swivel and 2 rigid. – Ruote antiraccia di cui 2 fisse e 2 girevoli, ruote posteriori bloccabili.**





# CLEANING & SAFETY

## PULIZIA & SICUREZZA

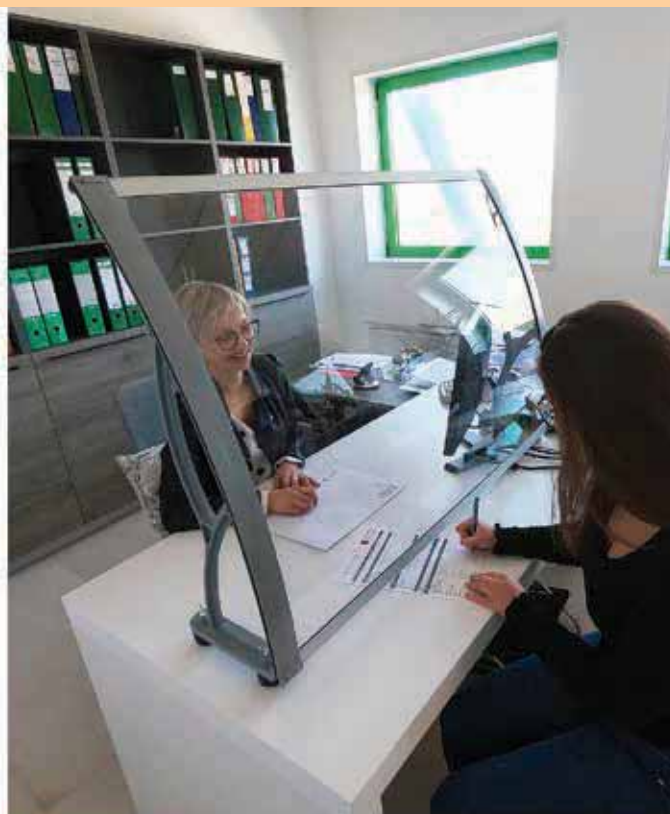



**PP**

**Changing table**

Fasciatoio da parete  
Windeln-Tisch  
Table à langer  
Mesa cambia-pañales

| art.     | cm.        |
|----------|------------|
| 49336-00 | 91x71x49,6 |
| 49336-02 | 60x88x48   |

**Rated for continuous use up to 23 kg. – Portata max in uso 23 kg.**



**PP**

**Sturdy chair**

Seggiolone  
Kinderstuhl  
Chaise d'enfant  
Silla niños

| art.     | cm.        |
|----------|------------|
| 49337-00 | 60x60x75,5 |
| 49337-01 | 29x47x8,3  |

**For children up to 3 years old or 18 kg weight. With Microban antimicrobial protection. – Adatto a bambini fino a 3 anni o 18 kg di peso. Con protezione antibatterica in Microban.**



**W**

**Sturdy chair**

Seggiolone  
Kinderstuhl  
Chaise d'enfant  
Silla niños

| art.     | cm.      | col. |
|----------|----------|------|
| 49335-01 | 50x50x75 | ●    |
| 49335-02 | 50x50x75 | ●    |

**Suitable for children from 6 months to 3 years. Max 20 kg. Adatto ai bambini da 6 mesi a 3 anni. Fino a 20 kg.**



**Trolley Quick Cart**

Carrello Quick Cart  
Quick Cart-Wagen  
Chariot Quick Cart  
Carretilla Quick Cart

| art.     | cm.      | Kg. | cap. m3 |
|----------|----------|-----|---------|
| 44178-01 | 42x36x43 | 6,5 | 0,05    |
| 44178-02 | 42x36x53 | 7,0 | 0,06    |

**Versatile compartments allow for multiple configurations and uses. Removable caddy. Adjustable dividers. Teflon fabric protector, repels water, oil and stains. Reinforced rubberised kick plate. – Scomparti versatili consentono molteplici configurazioni e usi. Cestello estraibile. Divisori removibili. Rivestimento in Teflon, respinge acqua, olio e macchie. Scocca rinforzata in gomma.**



**Collapsible frame, powder coated steel**

Telaio pieghevole, acciaio verniciato  
Klappbares Gestell, pulverbeschichtete Stahl  
Châssis repliable, acier peint  
Carre plegable, acero pintado

| art.     | cm.        | lt. |
|----------|------------|-----|
| 44178-15 | 51,5x61x84 | 150 |
| 44178-16 | 89x61x84   | 300 |

**Collapsible frame enables efficient storage. Compact, lightweight design for superior manoeuvrability. Remains collapsible with or without cover. – Telaio pieghevole consente uno stoccaggio efficiente. Design compatto e leggero per una maggiore manovrabilità. Rimane pieghevole con o senza copertura.**





**Vinyl bag, black**

Sacco vinile, nero  
Vinyl-Sack, schwarz  
Sac en vinyle, noir  
Bolsa de vinilo, negro

| art.     | cm.      | lt. |
|----------|----------|-----|
| 44178-17 | 39x57x69 | 150 |
| 44178-18 | 78x57x69 | 300 |

**Durable, high capacity (100 kg) vinyl bag accommodates large loads; easy-to-clean.** – Sacchi in vinile durevoli, ad alta capacità (100 kg); facili da pulire.



**Vinyl bag cover, black**

Copertura vinile, nero  
Vinyl-Sack-deckel, schwarz  
Couvercle à sac en vinyle, noir  
Tapa para bolsa de vinilo, negro

| art.     | cm.      |
|----------|----------|
| 44178-19 | 64x50x23 |
| 44178-20 | 89x66x23 |

**Multiple, built-in storage pockets on each side. Convenient, Quick-Access-Lid provides easy access to contents inside of cart without having to remove cover.** – Con tasche integrate su ogni lato. Comodo, accesso rapido all'interno del carrello, senza dover rimuovere il coperchio.



SS

**Service trolley**

Carrello servizio  
Servierwagen  
Chariot de service  
Carro de servicio

| art.     | cm.        |
|----------|------------|
| 44096-01 | 120x52x137 |

**Stainless steel structure. MDF cherry wood tops. 2 folding bag holders with linen laundry bag. Gray rubber bumpers. Castor wheels ø 12.5 cm.**  
Struttura inox. Piani in nobilitato color ciliegio. 2 reggisacchi pieghevoli con sacco in tela. Paracolpi in gomma grigia. Ruote piroettanti ø 12,5 cm.



SS

**Service trolley**

Carrello servizio  
Servierwagen  
Chariot de service  
Carro de servicio

| art.     | cm.        |
|----------|------------|
| 44096-02 | 119x52x134 |

**Stainless steel tube structure. MDF cherry tops and panels. Folding bag holder with linen laundry bag. Base with perimeter bumper in gray non-marking rubber. Castor wheels ø 15 cm.** – Struttura inox. Piani e pannelli in nobilitato color ciliegio. Reggisacchi pieghevoli con sacco in tela. Base con paracolpi perimetrale in gomma grigia antitraccia. Ruote piroettanti ø 15 cm.



SS

**Service trolley**

Carrello servizio  
Servierwagen  
Chariot de service  
Carro de servicio

| art.     | cm.        |
|----------|------------|
| 44096-03 | 139x52x134 |

**Stainless steel structure. MDF cherry tops and panels. Folding bag holder with linen laundry bag. Base with perimeter bumper in gray non-marking rubber. Castor wheels ø 15 cm.** – Struttura inox. Piani e pannelli in nobilitato color ciliegio. Reggisacchi pieghevoli con sacco in tela. Base con paracolpi perimetrale in gomma grigia antitraccia. Ruote piroettanti ø 15 cm.



PP

**Service trolley**

Carrello di servizio  
Servicewagen  
Chariot de service  
Carro de habitaciones

| art.     | cm.        | lt.     | Kg.  |
|----------|------------|---------|------|
| 44174-24 | 177x58x107 | 120+120 | 26,4 |

**Wheels ø 125 mm, 2 bag holders + 2 bags lt 120. Made in PP copolymer.**  
Ruote ø 125 mm, 2 portasacchi pieghevoli + 2 sacco lt 120. Prodotto in PP copolimero.





PP

**Service trolley**

Carrello di servizio  
Servicewagen  
Chariot de service  
Carro de habitaciones

| art.     | cm.        | lt. | Kg. |
|----------|------------|-----|-----|
| 44177-12 | 104x56x130 | 150 | 26  |

**Frame in tubular steel rilsan coated. Wheels ø 125 mm. 3 wooden shelves 50x46 cm. Bag holder + canvas bag polyester 55x55x94 cm.**  
Montanti in tubolare inox verniciato rilsan. Ruote ø 125 mm. 3 ripiani in legno 50x46 cm. Portasacco+sacco in tela poliestere 55x55x94 cm.



PP

**Housekeeping cart for linen collection**

Carrello portabiancheria  
Hotelwäschewagen  
Chariot d'étage à linge  
Carro de recogida de ropa

| art.     | cm.        | lt. | Kg.  |
|----------|------------|-----|------|
| 44176-30 | 105x55x105 | 300 | 12,5 |

**Frame in tubular steel rilsan coated. Wheels ø 125 mm. Nylon bag.** – Montanti in tubolare inox verniciato rilsan. Ruote ø 125 mm. Sacco in nylon plastificato.



**Housekeeping cart for linen collection**

Carrello portabiancheria  
Hotelwäschewagen  
Chariot d'étage à linge  
Carro de recogida de ropa

| art.     | cm.       | lt. | Kg.  |
|----------|-----------|-----|------|
| 44175-15 | 62x60x103 | 150 | 6,39 |

**Capacious canvas bag laminated washable at 30°C. Folding frame. Swivel casters ø 80 mm.**  
Capiente sacco in tela plasticata lavabile a 30°C. Telaio pieghevole. Ruote piroettanti ø 80 mm.



**Cleaning system, Pulse**

Sistema di pulizia, kit Pulse  
Reinigungssystem Pulse  
Système de nettoyage Pulse  
Sistema de limpieza Pulse

| art.     | cm.          |
|----------|--------------|
| 44151-00 | 12,4x9,5x142 |

**Aluminum frame 40 cm and 2 microfibre mops. On-board reservoir 700 ml that allows to clean up to 80 sqm.** – Telaio in alluminio con velcro da 40 cm, 2 mop in microfibra. Dotato di deposito integrato da 700 ml che permette di pulire fino a 80 mq.



**Microfibre mops**

Mop in microfibra  
Microfiber-Mops  
Franges en microfibre  
Fregadoras de microfibra

| art.     | cm.   | des.        | U. Pack |
|----------|-------|-------------|---------|
| 44151-AA | 40x14 | Wet         | 10      |
| 44151-AB | 40x14 | High absorb | 10      |
| 44151-AC | 40x14 | Scrubber    | 10      |

**Wet use, high absorbency, for 80 sqm. Launderable up to 500 times (200 with bleach) at high water temperature.** – Uso umido ad elevata assorbenza 80 mq. Ciclo di vita: 500 lavaggi (200 con candeggina) ad elevate temperature.



**Dust beater "V" sweeper complete**

Scopa a forbice completa  
Doppel-Wischmop  
Balai double mop  
Escoba doble

| art.     | h. cm. |
|----------|--------|
| 44160-03 | 135    |

**Opening angle 140° about. Cotton mops length 100 cm.** – Apertura 140° circa. Frange in cotone 100 cm.



**Mechanical sweeper**

Aspirapolvere meccanico  
Kehrer mit mechanischem Antrieb  
Balai mécanique  
Escoba mecánica

| art.     | cm.         | lt. |
|----------|-------------|-----|
| 44150-19 | 28,5x25x102 | 0,6 |

**ABS and galvanised steel construction. Ideal for hard floors and low pile carpets. Sweeping path 19 cm.** – ABS e acciaio galvanizzato. Ideale sia per tappeti/moquette a pelo corto che per pavimenti. Battuta 19 cm.



PP

**Broom + dust pan**

Scopa + alza immondizia  
Kehrset mit Stiel und Schmutzcontainer  
Balai + pelle  
Escoba + recogedor

| art.     | cm.          |
|----------|--------------|
| 44149-03 | 28,6x13x32,5 |

**Self opening and closing lid. Broom hanger bracket.** – Porta immondizia con coperchio. Staffa di supporto per scopa.



**Dustpan**

Paletta manico lungo  
Müllschaufel  
Pelle à poussière  
Pala

art. 44170-00



**Broom, aluminum rod**

Scopa, manico alluminio  
Besen mit Alustiel  
Balai, manche alu  
Escoba, mango alumimio

art. h. cm.  
44170-01 80



**Cleaning wand**

Scopa spingiacqua  
Abzieher  
Balai raclette  
Escoba

art. cm.  
44148-01 116,8x40

**Blade made of soft double mass squeegee foam supported by a galvanized metal frame.**

Testa della scopa realizzata in morbida gommaspugna a doppio strato sostenuta da telaio in metallo galvanizzato.



**Wet mop handles**

Manico per mop  
Nassmopp-Stiele  
Supports pour franges  
Mangos para fregonas

art. cm. col.  
44141-01 152,4 ●  
44141-03 152,4 ●

**Polypropylene/Glass fiber.**  
Polipropilene/fibra di vetro.



**Cotton-end string mop**

Mop a strisce in cotone  
Spaghetti-Mop mit Baumwollenen  
Frangé à ficelles en coton  
Mopa de algodón

art. gr.  
44142-40 400



**Cotton mop rod, screw fitting**

Manico per mop, attacco filettato  
Mop-Stange mit Schraubanschluss  
Manche pour mop avec attache à vis  
Mango para fregadora, conexión tornillo

art. Ø cm. cm.  
44167-13 2,2 130

**Red lacquered iron. Lightweight and rustproof.**  
Ferro verniciato rosso. Leggero ed inossidabile.



**Cotton mop, screw fitting**

Mop in cotone, attacco filettato  
Baumwollmop mit Schraubanschluss  
Mop en coton avec attache à vis  
Mopa de algodón

art. gr.  
44166-28 280



**Telescopic rod**

Manico telescopico  
Teleskopstange  
Manche telescopique  
Mango telescópico

art. Ø cm. cm.  
44161-00 2,3 97>184

**Two-piece anodized aluminum rod.**  
Alluminio anodizzato due pezzi.



**Mop holder**

Pinza per mop  
Wischmophalter  
Pince faubert  
Pinza

art. 44164-00

**Universal ring allows the use of any handle with from ø 20 to 24 mm. – Ghiera universale consente l'utilizzo di qualsiasi manico con ø 20>24 mm.**





**Cotton-end string mop**

Mop a strisce in cotone  
Spaghetti-Mop mit Baumwollend  
Frange à ficelles en coton  
Mopa de algodón

| art.     | gr. |
|----------|-----|
| 44165-35 | 350 |
| 44165-40 | 400 |
| 44165-50 | 500 |



**Microfibre cloth, 12 pcs**

Panno in microfibra, 12 pz  
Mikrofasertuch, 12 Stk  
Carré en microfibra, 12 pcs  
Paño de microfibra, 12 pz

| art.     | cm.       | col. |
|----------|-----------|------|
| 44147-00 | 40,6x40,6 | ●    |
| 44147-01 | 40,6x40,6 | ●    |
| 44147-02 | 40,6x40,6 | ●    |
| 44147-03 | 40,6x40,6 | ●    |

**Launderable up to 100 times with bleach and 250 without bleach. – Dura 100 lavaggi con candeggina e 250 senza.**



PP

**2-sided floor sign**

Cavalletto di segnalazione a 2 lati  
2-seitig, Warnschild  
Panneau d'avertissement 2 côtés  
Señal de suelo 2 lados

| art.     | h. cm. |
|----------|--------|
| 44077-00 | 57     |
| 44077-CC | 67     |



NEW

**Safety chain for floor signs**

Catenella di sicurezza per cavalletti  
Kunststoff-Kette für Warnschilder  
Chaîne de sécurité pour panneaux de sol  
Cadena plástica para señales de suelo

| art.     | cm. |
|----------|-----|
| 44077-06 | 600 |



NEW

**Telescopic door sign**

Segnalatore telescopico di sicurezza  
Teleskop-Sicherheitstürschild  
Panneau de sécurité télescopique  
Señal de seguridad telescópico

| art.     |
|----------|
| 44077-10 |



NEW

**Sanitizing detergent**

Detergente igienizzante  
Desinfektionsmittel  
Détergent désinfectant  
Detergente desinfectante

| art.     | lt. |
|----------|-----|
| 48610-50 | 5   |

**For hard surfaces. – Per superfici dure.**



PP

**Multi-purpose trolley**

Carrello multiuso  
Allzweckwagen  
Chariot multi-usage  
Carro de limpieza

| art.     | cm.       |
|----------|-----------|
| 44173-00 | 97x68x111 |

**Bag holder with cover, bag lt. 120, pan with hooks, 2 buckets 4 lt. and 2 buckets 15 lt., wringer. – Portasacco con cop., sacco lt. 120, vaschetta con ganci, 2 secchi 4 lt., 2 secchi 15 lt., strizzatore.**



PP

**Mopping trolley with press**

Carrello lavapavimenti con strizzatore  
Wringer Reinigungswagen mit Presse  
Chariot de ménage avec presse  
Carro con prensa escurridora

| art.     | cm.      |
|----------|----------|
| 44171-24 | 62x42x90 |

**Wringer and 25 lt. bucket. With storage compartment. PSV reinforced handle. Strizzatore e 1 secchio lt. 25. Vano portaoggetti. Impugnatura in PSV completa di rinforzi.**



PP

**Mopping trolley with press**

Carrello lavapavimenti con strizzatore  
Wringer Reinigungswagen mit Presse  
Chariot de ménage avec presse  
Carro con prensa escurridora

| art.     | cm.      |
|----------|----------|
| 44171-50 | 69x42x90 |

**Wringer and 2 buckets lt. 25 each. Painted handle, reversible. – Strizzatore e 2 secchi da lt. 25. Impugnatura verniciata, reversibile.**



PP

**Mopping trolley with press**  
 Carrello lavapavimenti con strizzatore  
 Wringer Reinigungswagen mit Presse  
 Chariot de ménage avec presse  
 Carro con prensa escurridora

| art.     | cm.      |
|----------|----------|
| 44172-30 | 47x40x93 |

**Single tank with wringer.**  
 Monovasca con strizzatore.



PP

**Graduated bucket**  
 Secchio graduato  
 Eimer mit Skala  
 Seau gradué  
 Cubo con medidas

| art.     | cm.        | lt. | col. |
|----------|------------|-----|------|
| 44169B06 | 24x19x21,5 | 6   | ●    |
| 44169R06 | 24x19x21,5 | 6   | ●    |



PP

**Graduated bucket**  
 Secchio graduato  
 Eimer mit Skala  
 Seau gradué  
 Cubo con medidas

| art.     | cm.        | lt. | col. |
|----------|------------|-----|------|
| 44169B14 | 34x33,5x28 | 15  | ●    |
| 44169R25 | 37x36,5x32 | 25  | ●    |



PP

**Bucket with wringer**  
 Secchio con strizzatore  
 Eimer mit Presse  
 Seau avec essoreur  
 Cubo con prensa

| art.     | cm.        | lt. |
|----------|------------|-----|
| 44168-12 | 35x27x29,5 | 12  |

**With graduated scale 0-12 lt.**  
 Scala graduata 0-12 lt.



PP

**Waste container**  
 Cestino  
 Abfallbehälter  
 Collecteur  
 Papelera

| art.     | Ø cm. | h. cm. |
|----------|-------|--------|
| 44097-00 | 30    | 32     |



PE

**Step on bin**  
 Pattumiera a pedale  
 Pedaleimer  
 Poubelle à pédale  
 Colector a pedal

| art.     | cm.        | lt. |
|----------|------------|-----|
| 49933-30 | 50x31x56,5 | 30  |
| 49933-50 | 53x34x72   | 50  |
| 49933-68 | 56x37x78   | 68  |



**Waste container SLIM JIM**  
 Contenitore rifiuti  
 Abfallbehälter  
 Collecteur  
 Colector

| art.     | cm.      | lt. |
|----------|----------|-----|
| 49931-60 | 59x28x63 | 60  |
| 49931-87 | 56x28x76 | 87  |



PP

**Hinged lid**  
 Coperchio ancorato  
 Klapp-Deckel  
 Couvercle à charnière  
 Tapa abatible

| art.     | cm.       |
|----------|-----------|
| 49931-00 | 55,6x34x3 |





PP

**Lid**  
Coperchio  
Deckel  
Couvercle  
**Tapa**

| art.     | cm.     | col. |
|----------|---------|------|
| 49931A00 | 52x29x7 | ●    |
| 49931C04 | 52x29x7 | ●    |
| 49931B05 | 52x29x7 | ●    |
| 49931B02 | 52x29x7 | ●    |
| 49931B03 | 52x29x7 | ●    |
| 49931B01 | 52x29x7 | ●    |



PP

**Dolly SLIM JIM**  
Carrello  
Transportwagen  
Chariot  
**Carrito**

| art.     | cm.          |
|----------|--------------|
| 49931-64 | 60,6x37,4X21 |

**Side clip allows to tow together more trolleysdal release fast and simple.** – Aggancio laterale a clip che permette di trainare insieme diversi carrelli. Rilascio a pedale semplice e veloce.



PE

**Mobile pedal bin**  
Pattumiera a pedale  
Pedaleimer  
Poubelle à pédale  
Colector a pedal

| art.     | cm.      | lt. |
|----------|----------|-----|
| 44095-12 | 48x55x93 | 120 |

**Certified UNI EN 840. Withstanding chemical, can be washed and sterilized.**  
Certificata UNI EN 840. Resistente agli agenti chimici, lavabile e sterilizzabile.



PP

**Mobile pedal bin**  
Pattumiera a pedale  
Pedaleimer  
Poubelle à pédale  
Colector a pedal

| art.     | cm.      | lt. |
|----------|----------|-----|
| 44095-18 | 40x65x81 | 80  |



PP

**Mobile pedal bin**  
Pattumiera a pedale  
Pedaleimer  
Poubelle à pédale  
Colector a pedal

| art.     | cm.      | lt. | col. |
|----------|----------|-----|------|
| 44096-80 | 48x50x78 | 80  | ○    |
| 44096B80 | 48x50x78 | 80  | ●    |
| 44096Y80 | 48x50x78 | 80  | ●    |
| 44096R80 | 48x50x78 | 80  | ●    |
| 44096G80 | 48x50x78 | 80  | ●    |



NEW

PP

**Mobile pedal bin**  
Bidone a pedale  
Pedaleimer  
Poubelle à pédale  
Colector a pedal

| art.     | cm.       | lt. |
|----------|-----------|-----|
| 44098-08 | 48x50x78  | 80  |
| 44098-12 | 48x55x93  | 120 |
| 44098-24 | 58x73x107 | 240 |



NEW

**Label Covid-19**  
Etichetta COVID-19  
Etikett Covid-19  
Étiquette Covid-19  
Etiqueta Covid-19

| art.     | dim. cm. |
|----------|----------|
| 44098-03 | 15x21    |



**Refuse bag holder trolley**  
Carrello portasacco  
Sackhalterwagen  
Chariot porte-sac  
Colector móvil

| art.     | cm.       | lt. |
|----------|-----------|-----|
| 44089-12 | 58x56x102 | 120 |





PP

**Mobile pedal bin, fire-proof**

Pattumiera a pedale, ignifuga  
Pedaleimer, feuersicher  
Poubelle à pédale, ignifugée  
Colector a pedal, ignifugo

| art.     | cm.      | lt. | col. |
|----------|----------|-----|------|
| 49899-01 | 46x32x80 | 70  | ●    |

**Mechanical parts in stainless steel. The lid can be removed.** – Parti meccaniche in acciaio inox. Coperchio staccabile.



**Pedal bin lids**

Coperchi pattumiera  
Pedaleimer-Deckel  
Couvercles poubelle  
Tapas para colector

| art.     | cm.   | col. |
|----------|-------|------|
| 49899-91 | 46x32 | ●    |
| 49899-92 | 46x32 | ●    |
| 49899-93 | 46x32 | ●    |
| 49899-94 | 46x32 | ●    |
| 49899-95 | 46x32 | ●    |



PE

**Tilt truck**

Benna ribaltabile  
Falten Eimerwagen  
Benne  
Carrito plegable

| art.     | cm.        | lt. | Kg. |
|----------|------------|-----|-----|
| 49934-04 | 145x68x86  | 400 | 205 |
| 49934-06 | 164x77x97  | 600 | 272 |
| 49934-08 | 180x85x107 | 800 | 570 |



PE

**Domed linged lid**

Coperchio a doppia apertura  
Doppel-Deckel  
Couvercle double  
Tapa doble

| art.     | cm.       |
|----------|-----------|
| 49934-14 | 132x71x23 |
| 49934-16 | 155x81x23 |
| 49934-18 | 169x87x23 |



PP

**Folding ladder**

Scaletta pieghevole  
Klappleiter  
Marche-pied pliable  
Escalera plegable

| art.     | cm.        |
|----------|------------|
| 49378-48 | 48,6x17x63 |

**Load 150 kg. Resists from 0 to 50 °C.**  
Carico 150 kg. Resiste da 0 a 50°C.



PE

**Pallet**

Pallet  
Pallet  
Palette  
Racks para suelos

| art.     | cm.       | Kg. |
|----------|-----------|-----|
| 49373-05 | 80x120x14 | 4,6 |

**Static load 1000 kg. Appropriate for food.**  
Carico statico 1000 kg. Per uso alimentare.



**Dunnage rack**

Pedana  
Lageruntersätze  
Palettes  
Bancada

| art.     | cm.          | load kg |
|----------|--------------|---------|
| 49371-09 | 91,4x56x30,5 | 68      |
| 49371-12 | 122x56x30,5  | 136     |

**Rust and corrosion-proof polymer material.**  
Materiale polimerico resistente alla ruggine e alla corrosione.





SS

**Floor standing ashtray**  
Posacenere a colonna  
Standascher/Abfalleimer  
Cendrier sur pied  
Contenedor con cenicero

| art.     | Ø cm. | h. cm. |
|----------|-------|--------|
| 49897-09 | 9     | 86     |



SS

**Standing ashtray/bin**  
Posacenere/pattumiera  
Standascher/Abfalleimer  
Cendrier/poubelle  
Cenicero/papelera

| art.     | Ø cm. | h. cm. |
|----------|-------|--------|
| 49898-30 | 30    | 60     |



PP

**Standing ashtray**  
Posacenere/fioriera  
Standascher  
Cendrier sur pied  
Cenicero

| art.     | Ø cm. | h. cm. |
|----------|-------|--------|
| 49892-40 | 40    | 60     |

**Included bag of sand 1,5 kg.**  
Incl. sacchetto sabbia kg 1,5.

## HYGIENE ACCESSORIES ACCESSORI PER L'IGIENE



NEW

**Hand hygiene station**  
Stazione igiene mani  
Händehygenestation  
Station de désinfection des mains  
Estación de higiene de manos

| art.     | cm.          |
|----------|--------------|
| 44178-69 | 93x38,5x19,5 |

**Dispenser not included.** – Erogatore non incluso.



NEW

**Automatic dispenser**  
Erogatore automatico  
Automatischer Spender  
Distributeur automatique  
Dispensador automático

| art.     | cm.            |
|----------|----------------|
| 44178-66 | 14,2x14,2x28x4 |

**Dose: 0,4 ml.**



NEW

**Cleansing foam**  
Schiuma detergente  
Reinigungsschaum  
Mousse nettoyante  
Espuma limpiadora

| art.     | cm.       | ml.  |
|----------|-----------|------|
| 44178-67 | 26,5x16x7 | 1100 |

**Dye-free and fragrance-free.**  
Priva di coloranti e senza profumo.



NEW

**Sanitizing gel**  
Gel igienizzante  
Desinfektionsgel  
Gel désinfectant  
Gel desinfectante

|          |     |
|----------|-----|
| art.     | ml. |
| 48601-05 | 500 |

**With alcohol for a sanitizing action. Enriched with glycerin and chamomile to moisturize the skin.**  
Con alcol ad azione igienizzante. Arricchito con glicerina e camomilla per idratare.



NEW

**Forehead infrared thermometer**  
Termometro infrarossi frontale  
Infrarot-Stirnthermometer  
Thermomètre infrarouge frontal  
Termómetro infrarrojo delantero

|          |              |         |
|----------|--------------|---------|
| art.     | cm.          | range   |
| 49726-00 | 2,5x5,6x12,8 | 32+42°C |

**With Biomaster anti-bacterial additive. Resolution: 0,1°C/°F. Accuracy: ± 0,3°C. No medical device.** – Con additivo antibatterico Biomaster. Risoluzione: 0,1°C/°F. Precisione: ± 0,3°C. Non è dispositivo medico.



NEW

**Face masks**  
Mascherine monouso  
Einwegmasken  
Masques jetables  
Mascarillas desechables

|          |         |
|----------|---------|
| art.     | U. Pack |
| 48551-00 | 50      |

**No medical device.** – Non è un presidio medico.



NEW

PC

**Face shield**  
Visiera facciale  
Gesichtsschutz  
Écran facial  
Visera

|          |     |           |
|----------|-----|-----------|
| art.     | my  | cm.       |
| 48550-00 | 375 | 29,4x20,5 |

**Hypoallergenic sponge, plasticized band, adjustable velcro closing, washable with alcohol. No medical device.** – Spugna anallergica, fascia plasticata, velcro di chiusura regolabile, lavabile con alcool. Non è un presidio medico.



**Gloves, nitrile**  
Guanti nitrile  
Handschuhe, Nitril  
Gants en nitrile  
Guantes de nitrilo

|          |        |         |
|----------|--------|---------|
| art.     | pcs/pz | size/T. |
| 48519-01 | 100    | S       |
| 48519-02 | 100    | M       |
| 48519-03 | 100    | L       |
| 48519-04 | 100    | XL      |

**Treatment Powder free. Latex-free. Finish microgrip.** – Trattamento Powder free. Latex free. Finitura Microgrip.



HDPE

**Gloves**  
Guanti  
Handschuhe  
Gants  
Guantes

|          |        |        |          |
|----------|--------|--------|----------|
| art.     | l. cm. | pcs/pz | size/T.  |
| 48522-24 | 24     | 500    | one size |

**Palm and fingers microgrip finishing.**  
Finitura palmo e dita microgrip.



**Apron, LDPE**  
Grembiule LDPE  
Schurz, LDPE  
Tablier, LDPE  
Delantal, LDPE

|          |          |        |
|----------|----------|--------|
| art.     | dim. cm. | pcs/pz |
| 48524-75 | 75x120   | 50     |

**Waterproof and resistant, length 120 cm from the chest, total length 140 cm.**  
Impermeabile e resistente, lunghezza 120 cm dal petto, totale 140 cm.



**Paper cap**  
Bustina carta  
Papier Mütze  
Calot papier  
Gorro barco papel

|          |        |
|----------|--------|
| art.     | pcs/pz |
| 48528-00 | 100    |

**Double paper processing, absorbent, adjustable size, ventilated.** – Carta doppia lavorazione, fascia assorbi sudore, adesivo regolabile, aerata.



**Cap, TNT**

Cuffia, TNT  
Einweghauben, TNT  
Charlotte, TNT  
Cubrecabezas, TNT

| art.     | pcs/pz |
|----------|--------|
| 48527-00 | 100    |

**Pleated cap, TNT 16gr/m2, very light, soft elastic, ø 50 cm.** – Cuffia plissettata TNT 16gr/m2, molto leggera, morbido elastico, ø 50 cm.



**Visitor kit, TNT**

Kit visitatore, TNT  
Besucher-Kits, TNT  
Kit visiteur, TNT  
Conjunto visitador, TNT

| art.     |
|----------|
| 48525-03 |

**1 TNT overall and cap, 1 CPE overshoes.**  
1 camice e cuffia in TNT e 1 set copriscarpe CPE.



**PE**

**Overshoes**

Copriscarpe  
Überschuhe  
Sur-chaussures  
Cubrezapatos

| art.     | l. cm. | pcs/pz |
|----------|--------|--------|
| 48526-44 | 44     | 110    |

**PE double-thickness, waterproof, elastic ankle, embossed bottom.** – PE doppio spessore, impermeabili, elastico alla caviglia, fondo gofrato.



**NEW**

**Gel/gloves dispenser stand + gel wall support**

Stand gel/guanti + supporto murale gel  
Gel-/Hanschuhständer + Gel-Wandhalterung  
Support gel/gants + support mural gel  
Soporte gel/guantes + soporte gel de pared

| art.     | Ø cm. | h. cm.   |
|----------|-------|----------|
| 49961-10 | 28    | 105+24,5 |

**Painted steel.** – Acciaio verniciato.



**NEW**

**Gloves wall box dispenser**

Dispenser guanti murale  
Wand-Handschuhspender  
Distributeur de gants mural  
Dispensador de guantes de pared

| art.     | cm.        |
|----------|------------|
| 49961-01 | 25x13,5x10 |

**Painted steel.** – Acciaio verniciato.



**NEW**

**Gel dispenser wall support**

Supporto murale per gel  
Wandhalterung für Gel  
Support mural pour gel  
Soporte de pared para gel

| art.     | Ø cm. | cm.        |
|----------|-------|------------|
| 49961-02 | 9     | 19x12,5x10 |

**Painted steel.** – Acciaio verniciato.



**NEW**

**SS**

**Foot pedal gel dispenser**

Dispenser a pedale per gel  
Pedalspender für Gel  
Distributeur à pédales pour gel  
Dispensador a pedal para gel

| art.     | cm.       | Kg. |
|----------|-----------|-----|
| 49963-01 | 28x15x100 | 8   |

**Mobile or screw-on. Adapted to all pump bottles up to Ø 11 cm and from 7 to 30 cm height. Anti-theft: reduced opening 6 cm, screwed (allen key supplied).** – Mobile o avvitabile. Adattabile a tutti i dispenser fino a Ø 11 cm e H da 7 a 30 cm. Antifurto: apertura ridotta 6 cm, avvitata (chiave a brugola fornita).





NEW  
SS

**Gloves dispenser box**  
Dispenser guanti  
Handschuhspender  
Distributeur de gants  
Dispensador de guantes

| art.     | cm.       |
|----------|-----------|
| 49963-03 | 25x14x9   |
| 49963-04 | 26x8x13,5 |



NEW  
SS

**Gloves dispenser box**  
Dispenser guanti  
Handschuhspender  
Distributeur de gants  
Dispensador de guantes

| art.     | cm.           |
|----------|---------------|
| 49963-15 | 25,3x8,2x13,2 |



NEW  
SS

**Visitor's kit dispenser box**  
Dispenser kit visitatore  
Besucher-Kit-Spender  
Distributeur kit visiteur  
Dispensador conjunto visitador

| art.     | cm.            |
|----------|----------------|
| 49963-13 | 12,3x10,4x43,5 |



NEW  
SS

**Masks dispenser box**  
Dispenser mascherine  
Maskenspender  
Distributeur masques  
Dispensador de mascarillas

| art.     | cm.        |
|----------|------------|
| 49963-06 | 8,7x4,7x26 |



NEW  
SS

**Masks dispenser box**  
Dispenser mascherine  
Maskenspender  
Distributeur masques  
Dispensador de mascarillas

| art.     | cm.          |
|----------|--------------|
| 49963-17 | 8,7x4,7x25,8 |



NEW  
SS

**Caps dispenser box**  
Dispenser cuffie  
Haubenspender  
Distributeur de charlottes  
Dispensador redecillas

| art.     | cm.          |
|----------|--------------|
| 49963-08 | 26x10,5x28   |
| 49963-09 | 31x27,7x19,5 |



NEW  
SS

**Caps dispenser box**  
Dispenser cuffie  
Haubenspender  
Distributeur de charlottes  
Dispensador redecillas

| art.     | cm.            |
|----------|----------------|
| 49963-11 | 29,5x10,5x14,5 |



NEW  
SS

**Caps dispenser box**  
Dispenser cuffie  
Haubenspender  
Distributeur de charlottes  
Dispensador redecillas

| art.     | cm.            |
|----------|----------------|
| 49963-19 | 25,3x10,2x27,3 |



NEW  
SS

**Caps dispenser box**  
Dispenser cuffie  
Haubenspender  
Distributeur de charlottes  
Dispensador redecillas

| art.     | cm.         |
|----------|-------------|
| 49963-21 | 29,7x9,6x13 |



**BARRIER SHIELDS PLEXIGLASS**  
PANNELLI PROTETTIVI PLEXIGLASS

NEW



An appealing, practical and quick solution for urgent social distancing requirements. Can be used in almost any location, such as supermarkets, petrol stations, bakeries, pharmacies, medical practices, meeting places, restaurants, sales counters, schools, cash points, office tables, conference rooms, receptions, counselling centres and many more. Can be placed on existing countertops as an added layer of protection. Available in a variety of sizes, with or without pass-through windows. A safe communication solution that offers excellent protection against infections spread by droplets of all kinds when talking to people during daily work and everyday life during and after a viral epidemic. Transparent plex material 5 mm thick. Interlocking feet. Available in standard or customized sizes on request. Packaging: transparent nylon + havana cardboard.

Una soluzione accattivante, pratica e rapida per le attuali esigenze di allontanamento sociale. Possono essere utilizzate in quasi tutti i luoghi, come supermercati, distributori di benzina, panetterie, farmacie, studi medici, luoghi di incontro, ristoranti, sportelli, scuole, scrivanie, tavoli d'ufficio, sale conferenze, ricevimenti, centri di consulenza e molti altri. Possono essere posizionati su tutte le superfici esistenti come ulteriore livello di protezione. Disponibili in varie dimensioni, con o senza finestre passanti. Una soluzione di comunicazione sicura che offre un'eccellente protezione contro le infezioni diffuse da goccioline di ogni tipo quando si parla alle persone durante il lavoro e la vita quotidiana e dopo un'epidemia virale. Materiale plex trasparente spessore 5 mm. Piedini ad incastro. Disponibili in misure standard o personalizzate su richiesta. Imballo: nylon trasparente+cartone avana.



**Sneeze guard with pass-through window**

Barriera protettiva con passacarte  
Hygieneschutz mit Durchreiche  
Panneau avec ouvertures passe-documents  
Mampara de protección con ventanilla abierta

| art.     | dim. cm. | h. cm. | window cm. |
|----------|----------|--------|------------|
| 48710-02 | 60x27,5  | 70     | 25x15      |
| 48710-03 | 80x27,5  | 70     | 25x15      |
| 48710-01 | 100x27,5 | 70     | 25x15      |

**Interlocking base supports 27,5x28 cm. – Basi supporto ad incastro 27,5x28 cm.**



**Sneeze guard with pass-through window**

Barriera protettiva con passacarte  
Hygieneschutz mit Durchreiche  
Panneau avec ouvertures passe-documents  
Mampara de protección con ventanilla abierta

| art.     | dim. cm. | h. cm. | window cm. |
|----------|----------|--------|------------|
| 48710-05 | 60x23    | 70     | 25x15      |
| 48710-06 | 80x23    | 70     | 25x15      |
| 48710-04 | 100x23   | 70     | 25x15      |
| 48710-08 | 60x23    | 90     | 25x15      |
| 48710-09 | 80x23    | 90     | 25x15      |
| 48710-07 | 100x23   | 90     | 25x15      |

**Interlocking base supports 23x40 cm. – Basi supporto a incastro 23x40 cm.**





**Sneeze guard**  
 Barriera protettiva  
 Hygieneschutz  
 Panneau de protection  
 Mampara de protección

| art.     | dim. cm. | h. cm. |
|----------|----------|--------|
| 48711-02 | 60x23    | 70     |
| 48711-03 | 80x23    | 70     |
| 48711-01 | 100x23   | 70     |

**Interlocking base supports 27,5x28 cm. –** Basi supporto a incastro 27,5x28 cm.



**Sneeze guard**  
 Barriera protettiva  
 Hygieneschutz  
 Panneau de protection  
 Mampara de protección

| art.     | dim. cm. | h. cm. |
|----------|----------|--------|
| 48711-05 | 60x23    | 70     |
| 48711-06 | 80x23    | 70     |
| 48711-04 | 100x23   | 70     |
| 48711-08 | 60x23    | 90     |
| 48711-09 | 80x23    | 90     |
| 48711-07 | 100x23   | 90     |

**Interlocking base supports 23x40 cm. –** Basi supporto a incastro 23x40 cm.



**Sneeze guard - BAR PROTECTION**

Barriera protettiva  
 Hygieneschutz  
 Panneau de protection  
 Mampara de protección

| art.     | dim. cm. | h. cm. | window cm. |
|----------|----------|--------|------------|
| 48712-08 | 80x20    | 70     | 60x20      |
| 48712-10 | 100x20   | 70     | 79x20      |

**Interlocking base supports 20x55 cm. –** Basi supporto a incastro 20x55 cm.



**Sneeze guard - COUNTER BARRIER**

Barriera protettiva  
 Hygieneschutz  
 Panneau de protection  
 Mampara de protección

| art.     | dim. cm. | h. cm. |
|----------|----------|--------|
| 48713-08 | 80x20    | 50     |
| 48713-10 | 100x20   | 50     |
| 48713-15 | 150x20   | 50     |

**Interlocking base supports 20x32 cm. –** Basi supporto a incastro 20x32 cm.



**Self-standing guard**  
 Barriera autoportante  
 Hygieneschutz, freistehend  
 Panneau de protection autoportante  
 Mampara de protección de suelo

| art.     | dim. cm. | h. cm. |
|----------|----------|--------|
| 48714-19 | 150x100  | 190    |





**Table sneeze guard**

Barriera da tavolo  
Tisch-Hygienschutz  
Panneau de protection de table  
Mampara de protección de mesa

| art.     | dim. cm. | h. cm. |
|----------|----------|--------|
| 48715-07 | 70x30    | 65     |



**Table sneeze guard - OUTDOOR**

Barriera da tavolo  
Tisch-Hygienschutz  
Panneau de protection de table  
Mampara de protección de mesa

| art.     | dim. cm. | h. cm. |
|----------|----------|--------|
| 48716-07 | 70x8     | 65     |

**Adjustable wind-stop system.** – Sistema di fissaggio antivento adattabile alla misura del tavolo.

**BARRIER SHIELD**  
BARRIERA PROTETTIVA

NEW

**Solid self-supporting structure in aluminum and PP resin. Ultra-clear screen. Attractive design. Rubber feet. Opening for pass-through of documents height 3,5 cm. If desired can be fixed to the surface with double-sided tape or screws. Made of 3 mm thick transparent compact polycarbonate. Washable and sanitizable with non aggressive detergent solutions. Components easily assembled without need of special tools. Equipped with handles to easily be move elsewhere. Adaptable to most sales counters thanks to the possibility of placing modules side by side. Packaging with instruction sheet and screws/bolts kit.**

Solida struttura autoportante in alluminio e resina PP. Schermo ultratrasparente. Design accattivante. Piedini di sostegno. Apertura per passaggio documenti altezza 3,5 cm. Possibilità di fissaggio sulla superficie di appoggio tramite biadesivo o viti. Realizzata in policarbonato compatto trasparente di spessore 3 mm. Lavabile ed igienizzabile con soluzioni detergenti non aggressive. Componenti facilmente assemblabili senza l'utilizzo di attrezzi particolari. Dotata di maniglie per facilitarne lo spostamento. Adattabile a gran parte dei banchi vendita grazie alla possibilità di affiancare i moduli. Confezione con foglio d'istruzioni e kit viti/bulloni.



**Sneeze guard**

Barriera protettiva  
Hygienschutz  
Panneau de protection  
Mampara de protección

| art.     | l. cm. | h. cm. |
|----------|--------|--------|
| 48701-08 | 80     | 80     |
| 48701-12 | 120    | 80     |

**Thickness 3 mm.** – Spessore 3 mm.

PC





**Tubular structure in stainless steel matte finish or black lacquered ø 63 mm, thickness 0,8 mm. 4-way retractable polyester black belt length 2,13 meters, width 4,8 cm. Ballasted base ø cm 31 with rubber under the base. Weight 10 kg. Overall height 1 mt. Possibility to apply landscape display.**

Struttura tubolare in acciaio inossidabile finitura satinata o laccata nera ø 63 mm, spessore 0,8 mm. Nastro retrattile 4-vie in poliestere nero lunghezza 2,13 metri, larghezza 4,8 cm. Base zavorrata ø 31 cm con gomma sotto la base. Peso 10 kg. Altezza totale 1 mt. Possibilità di applicare tabella segnaletica.



**Retractable belt stanchion, set 2 posts**

Aste delimita corsie nastro estensibile, set 2 pz

Absperrpfost mit einziehbarer Gurt, 2 Stk

Poteau avec ceinture rétractable, set 2 pcs

Poste con cinturón retráctil, 2 piezas

| art.     | Ø cm. | base Ø cm. | belt/nastro | h. cm. | Kg. |
|----------|-------|------------|-------------|--------|-----|
| 44183-01 | 6,3   | 36         | cm 213x4,8  | 100    | 10  |

**Black laquered.** – Laccato nero.



**Retractable belt stanchion, set 2 posts**

Aste delimita corsie nastro estensibile, set 2 pz

Absperrpfost mit einziehbarer Gurt, 2 Stk

Poteau avec ceinture rétractable, set 2 pcs

Poste con cinturón retráctil, 2 piezas

| art.     | Ø cm. | base Ø cm. | belt/nastro | h. cm. | Kg. |
|----------|-------|------------|-------------|--------|-----|
| 44184-01 | 6,3   | 36         | cm 213x4,8  | 100    | 10  |

**Stainless steel matt finish.** – Inox finitura satinata.



**Stanchion sign holder**

Tabella

Posterhalter

Porte-enseigne

Porta etiquetas

| art.     | dim. cm. |
|----------|----------|
| 44183-A4 | A4       |
| 44183-A3 | A3       |

**Black laquered.** – Laccato nero.



**Stanchion sign holder**

Tabella

Posterhalter

Porte-enseigne

Porta etiquetas

| art.     | dim. cm. |
|----------|----------|
| 44184-A4 | A4       |
| 44184-A3 | A3       |

**Stainless steel matt finish.** – Inox finitura satinata.



ROPE BARRIERS  
ASTE DELIMITA CORSIE

NEW



Tubular structure in polished or brass-plated stainless steel  $\varnothing$  6 cm. Eyelets for the attachment of the spring-hooks without direction constraint. Spring closure hooks in polished or brass-plated stainless steel. Twisted rope in synthetic material available in 4 colors, length 1 meter. Ballasted base  $\varnothing$  31 cm.

Struttura in tubolare di acciaio inox lucido o ottonato  $\varnothing$  6 cm. Anello per l'aggancio dei puntali senza vincolo di direzione. Puntali in acciaio inox lucido o ottonato. Treccia in materiale sintetico in 4 colori da 1 mt. Base zavorrata  $\varnothing$  31 cm.



**Stanchion**

Aste delimita corsie  
Kordel-Pfost  
Poteau de guidage  
Poste para cordón

| art.     | $\varnothing$ cm. | base $\varnothing$ cm. | h. cm. | Kg. | col. |
|----------|-------------------|------------------------|--------|-----|------|
| 44180-01 | 6                 | 31                     | 94     | 10  | ●    |
| 44181-01 | 6                 | 31                     | 94     | 10  | ●    |



**Spring closure hook**

Puntale con moschettone  
Karabiner mit Schnabberschluss  
Mousqueton pour cordon  
Terminación en gancho

| art.     | col. |
|----------|------|
| 44180-02 | ●    |
| 44181-02 | ●    |



**Twisted rope**

Cordone  
Kordel  
Corde tressé  
Cordón trenzado

| art.     | $\varnothing$ cm. | l. cm. | col. |
|----------|-------------------|--------|------|
| 44182-01 | 3                 | 100    | ●    |
| 44182-02 | 3                 | 100    | ●    |
| 44182-03 | 3                 | 100    | ●    |
| 44182-04 | 3                 | 100    | ●    |

Spring hook not included. – Puntale escluso.

# ELECTRIC APPLIANCES APPARECCHI ELETTRICI





**Dualit.**

**4 slot toaster**

Tostapane 4 fette  
Brotröster  
Grille pain  
Tostadora

| art.     | cm.      | Kg.  | kW  |
|----------|----------|------|-----|
| 49801-04 | 36x21x22 | 4,25 | 2,2 |



**Dualit.**

**6 slot toaster**

Tostapane 6 fette  
Brotröster  
Grille pain  
Tostadora

| art.     | cm.      | Kg. | kW |
|----------|----------|-----|----|
| 49801-06 | 46x21x22 | 5,1 | 3  |



**Dualit.**

**4 slice bun toaster**

Tostapane 4 fette  
Brotröster  
Grille pain  
Tostadora

| art.     | cm.      | Kg.  | kW |
|----------|----------|------|----|
| 49802-04 | 36x21x22 | 4,52 | 1  |



**Dualit.**

**6 slice bun toaster**

Tostapane 6 fette  
Brotröster  
Grille pain  
Tostadora

| art.     | cm.      | Kg.  | kW  |
|----------|----------|------|-----|
| 49802-06 | 46x21x22 | 5,52 | 1,5 |



**Conveyor Toaster**

Tostapane a nastro  
Durchlauf-Toaster  
Toaster convoyeur  
Tostador a túnel

| art.     | cm.      | Kg. | kW  |
|----------|----------|-----|-----|
| 49803-02 | 37x64x40 | 20  | 2,8 |



**Conveyor toaster, CT540 B**

Tostapane a nastro doppia uscita  
Durchlauf toaster  
Toaster convoyeur  
Tostador a túnel

| art.     | cm.        | Kg. | kW   |
|----------|------------|-----|------|
| 49850-20 | 50x68x34,5 | 20  | 2,65 |



**Toaster, BAR 1000**

Tostapane  
Toast-/Überbackgerät  
Toaster  
Tostador de pan

| art.     | cm.          | Kg. | kW |
|----------|--------------|-----|----|
| 49850-65 | 45x28,5x30,5 | 10  | 2  |



**Toaster, BAR 2000**

Tostapane  
Toast-/Überbackgerät  
Toaster  
Tostador de pan

| art.     | cm.        | Kg. | kW |
|----------|------------|-----|----|
| 49850-66 | 45x28,5x42 | 12  | 3  |



**Contact grill, SAVOYE**

Grill a contatto

Kontaktgrill

Grill à contact

Grill de contacto

| art.     | cm.        | Kg. | kW |
|----------|------------|-----|----|
| 49850-22 | 33x38,5x22 | 18  | 2  |

**Contact grill, PANINI**

Grill a contatto

Kontaktgrill

Grill à contact

Grill de contacto

| art.     | cm.        | Kg.  | kW |
|----------|------------|------|----|
| 49850-21 | 43x38,5x22 | 22,5 | 3  |

**Contact grill double plate, MAJESTIC**

Grill a contatto doppia piastra

Kontaktgrill, 2 Platten

Grill à contact, 2 plaques

Grill de contacto doble

| art.     | cm.        | Kg.  | kW  |
|----------|------------|------|-----|
| 49850-23 | 60x38,5x22 | 33,5 | 2x2 |

**Contact sandwich toaster**

Grill a contatto

Sandwich-Toaster

Appareil croque monsieur

Grill de contacto

| art.     | cm.      | Kg. | kW  |
|----------|----------|-----|-----|
| 49806-00 | 40x22x19 | 6   | 1,6 |

**Dualit.****Contact grill, PANINI XL**

Grill a contatto

Kontaktgrill

Grill à contact

Grill de contacto

| art.     | cm.      | Kg. | kW  |
|----------|----------|-----|-----|
| 49850-19 | 41x62x34 | 32  | 3,6 |

**Glas ceramic contact grill, GVS 335**

Grill a contatto vetroceramica

Kontaktgrill, Glaskeramik-Platte

Grill à contact vitroc ramique

Grill de contacto vitrocer mica

| art.     | cm.      | Kg. | kW |
|----------|----------|-----|----|
| 49850-18 | 39x60x26 | 14  | 3  |





**Salamander, SEM 600 PDS**

Salamandra  
Salamanders mit PDS  
Salamandre avec détection de plat  
Salamandra con PDS

| art.     | cm.      | Kg. | kW |
|----------|----------|-----|----|
| 49850-71 | 60x64x59 | 56  | 3  |



**Hot dog heater, CS 3 E**

Scalda würstel  
Würstchenwärmer  
Chauffe-saucisses  
Calentador de salchichas

| art.     | cm.      | Kg. | kW   |
|----------|----------|-----|------|
| 49850-61 | 44x30x40 | 9   | 0,65 |



**Kebab/Gyros grill, GR 40 E**

Griglia kebab/gyros  
Elektro-Dönergrill  
Gril à kebab/gyros  
Asador de kebab/gyros

| art.     | cm.        | Kg. | kW  |
|----------|------------|-----|-----|
| 49850-13 | 58x66x69,5 | 15  | 3,6 |



**Kebab/Gyros grill, GR 60 E**

Griglia kebab/gyros  
Elektro-Dönergrill  
Gril à kebab/gyros  
Asador de kebab/gyros

| art.     | cm.      | Kg. | kW  |
|----------|----------|-----|-----|
| 49850-14 | 58x66x87 | 25  | 5,8 |



**Crepe machine, high-capacity, CFE 400**

Creperia tonda, ad alto rendimento  
Crêpegerät  
Crêpière à haut rendement  
Crepera

| art.     | Ø cm. | h. cm. | Kg. | kW  |
|----------|-------|--------|-----|-----|
| 49850-33 | 40    | 20     | 18  | 3,6 |



**Double crepe machine, CDE 400**

Creperia doppia  
Crêpegerät, 2 Platten  
Crêpière double  
Crepera 2 placas

| art.     | Ø cm. | cm.      | Kg. | kW  |
|----------|-------|----------|-----|-----|
| 49850-11 | 40    | 45x50x24 | 23  | 3,6 |





**Single crepe machine, CSE 400**

Crepiera singola  
Crêpegerät  
Crêpière simple  
Crepera

| art.     | Ø cm. | cm.      | Kg. | kW    |
|----------|-------|----------|-----|-------|
| 49850-12 | 40    | 86x50x24 | 44  | 3,6x2 |



**Eggs boiler, CO 60**

Bollitore uova  
Eierkocher  
Cuisseur à oeuf  
Caldera para huevos

| art.     | cm.          | Kg. | kW  |
|----------|--------------|-----|-----|
| 49850-36 | 21,5x43x25,5 | 4,5 | 1,2 |



**Multifunction oven, FC 280**

Forno multifunzione  
Multifunktionsofen  
Four multifonctions  
Horno multifunción

| art.     | cm.        | Kg. | kW  |
|----------|------------|-----|-----|
| 49850-73 | 46x55x35,5 | 20  | 1,5 |



**Multifunction oven, FC 380 TQ**

Forno multifunzione  
Multifunktionsofen  
Four multifonctions  
Horno multifunción

| art.     | cm.        | Kg. | kW  |
|----------|------------|-----|-----|
| 49850-75 | 55x55x35,5 | 22  | 2,4 |



**Multifunction oven, FC 60 TQ**

Forno multifunzione  
Multifunktionsofen  
Four multifonctions  
Horno multifunción

| art.     | cm.        | Kg. | kW |
|----------|------------|-----|----|
| 49850-76 | 59,5x61x59 | 38  | 3  |



**Fryer, FD 80 R**

Friggitrice  
Fritteuse  
Friteuse  
Freidora

| art.     | cm.        | kg./H | Kg. | kW  |
|----------|------------|-------|-----|-----|
| 49850-41 | 26,5x45x36 | 15    | 8   | 3,6 |





**Fryer, FD 80 DR**

Friggitrice  
Fritteuse  
Friteuse  
Freidora

| art.     | cm.      | kg./H | Kg. | kW    |
|----------|----------|-------|-----|-------|
| 49850-42 | 59x45x37 | 30    | 15  | 2x3,6 |



**Fryer, FD 50**

Friggitrice  
Fritteuse  
Friteuse  
Freidora

| art.     | cm.          | kg./H | Kg. | kW  |
|----------|--------------|-------|-----|-----|
| 49850-37 | 21,5x42,5x32 | 10    | 5   | 3,2 |



**Fryer, FD 50 D**

Friggitrice  
Fritteuse  
Friteuse  
Freidora

| art.     | cm.        | kg./H | Kg. | kW    |
|----------|------------|-------|-----|-------|
| 49850-39 | 39x42,5x32 | 20    | 10  | 2x3,2 |



**Dish-warmer, DW106 / 110**

Scaldapiatti  
Rechaud  
Chauffe plats  
Calentador de platos

| art.     | cm.          | Kg. | kW   |
|----------|--------------|-----|------|
| 49850-06 | 40x21,5x33,5 | 14  | 0,65 |
| 49850-10 | 40x21,5x47,5 | 25  | 1,3  |



**Ventilated warming display, WD 780 SI**

Espositore caldo ventilato  
Konvektion-Warme Theke  
Présentoir chaud à convection  
Expositor caliente con convección

| art.     | cm.      | Kg. | kW  |
|----------|----------|-----|-----|
| 49850-69 | 78x49x48 | 30  | 1,2 |



**Ventilated warming display, WD 780 DI**

Espositore caldo ventilato  
Konvektion-Warme Theke  
Présentoir chaud à convection  
Expositor caliente con convección

| art.     | cm.      | Kg. | kW  |
|----------|----------|-----|-----|
| 49850-70 | 78x49x64 | 35  | 1,8 |



**Warming display**

Vetrina riscaldata  
Warmhalte-Vitrine  
Vitrine chauffante  
Vitrina caliente

| art.     | GN  | cm.        | Kg. | kW   | range     |
|----------|-----|------------|-----|------|-----------|
| 49850-43 | 1/1 | 59x35x28,5 | 12  | 0,65 | +20 +95°C |



**Warming display**

Vetrina riscaldata  
Warmhalte-Vitrine  
Vitrine chauffante  
Vitrina caliente

| art.     | GN     | cm.      | Kg. | kW   | range     |
|----------|--------|----------|-----|------|-----------|
| 49850-44 | 2x 1/1 | 59x35x39 | 15  | 0,65 | +20 +95°C |





**Tapas display**

Vetrina antipasti  
Vorspeisen-Schaufenster  
Vitrine tapas  
Vitrina para tapas

| art.     | cm.       | Kg. | W   | range   |
|----------|-----------|-----|-----|---------|
| 49630-06 | 145x40x26 | 33  | 160 | +2/+5°C |
| 49630-08 | 180x40x26 | 40  | 160 | +2/+5°C |

**Ice cream maker**

Macchina per gelato  
Eismaschine  
Machine à glace  
Maquinas helado

| art.     | cm.      | lt. | kg./H | Kg. | kW  |
|----------|----------|-----|-------|-----|-----|
| 49949-19 | 51x31x35 | 1,5 | 3     | 30  | 0,4 |

**Dehydrator for fruits and vegetables**

Disidratatore per frutta e verdura  
Dehydratisierapparat  
Déshydrateur fruits et légumes  
Deshidratador de frutas y verduras

| art.     | cm.        | Kg. | kW   | range     |
|----------|------------|-----|------|-----------|
| 49953-02 | 43,5x29x21 | 3,6 | 0,53 | +30 +80°C |

**Supplied with 6 reversible trays. Timer up to 72 hours.**  
6 vassoi reversibili. Timer fino a 72 ore.

**Smoker, 2 levels**

Affumicatoio a 2 piani  
Räucherofen  
Fumoir  
Ahumador

| art.     | cm.      | Kg. | kW  |
|----------|----------|-----|-----|
| 49850-63 | 45x45x35 | 25  | 1,5 |

**Table-top cutter**

Cutter da tavolo  
Gemüseschneidmaschine  
Cutter à légumes  
Cortador verduras

| art.     | cm.      | lt. | Kg. |
|----------|----------|-----|-----|
| 49979-03 | 32x52x62 | 3   | 12  |

**Electric peeler**

Pelatrice elettrica  
Elektr. Schälmachine  
Eplucheur électrique  
Pelador eléctrico

| art.     | cm.        | Kg. |
|----------|------------|-----|
| 49750-00 | 25x16x21,5 | 2   |





**Dualit.**

**Waffle iron**

Macchina per cialde  
Waffeleisen  
Gufrier  
Gofrera

| art.     | cm.      | Kg. | kW  |
|----------|----------|-----|-----|
| 49809-00 | 40x22x19 | 5,5 | 1,6 |



**Single waffle iron, GESIMPLE**

Macchina per cialde  
Waffeleisen mit 1 Platte  
Gaufrier simple  
Gofrera singular

| art.     | cm.        | Kg. | kW  |
|----------|------------|-----|-----|
| 49850-24 | 30,5x44x23 | 22  | 1,6 |
| 49850-25 | 30,5x44x23 | 22  | 1,6 |
| 49850-26 | 30,5x44x23 | 22  | 1,6 |
| 49850-27 | 30,5x44x23 | 22  | 1,6 |



**Double waffle iron, GESDOUBLE**

Macchina per cialde doppia  
Waffeleisen mit 2 Platten  
Gaufrier double  
Gofrera doble

| art.     | cm.      | Kg. | kW  |
|----------|----------|-----|-----|
| 49850-28 | 55x44x23 | 38  | 3,2 |
| 49850-29 | 55x44x23 | 38  | 3,2 |
| 49850-30 | 55x44x23 | 38  | 3,2 |
| 49850-31 | 55x44x23 | 38  | 3,2 |



-24 / -28



-25 / -29



-26 / -30



-27 / -31



**Single waffle iron, GES23**

Macchina per cialde  
Waffeleisen mit 1 Platte  
Gaufrier simple  
Gofrera singular

| art.     | cm.        | Kg. | kW  |
|----------|------------|-----|-----|
| 49850-03 | 30,5x44x23 | 22  | 1,6 |



SS

**Infrared lamp with warming plate**

Lampada ad infrarossi con piano caldo  
Infrarot Wärmebrücke mit Wärmeplatte  
Lampe infrarouge avec plaque chauffante  
Lámpara infrarrojos y placa caliente

| art.     | GN  | cm.       | kW  |
|----------|-----|-----------|-----|
| 49993-21 | 1/1 | 38x53x70  | 0,5 |
| 49993-22 | 2/1 | 70x53x71  | 1,0 |
| 49993-23 | 3/1 | 103x53x70 | 1,5 |

**Curved plexiglass fender. Separate switches for plate and lamps. Adjustable thermostat +30°C +90°C.** – Parafiato in plexiglass curvo. Interruttori di accensione separati per piano caldo e lampade. Termostato regolabile +30°C +90°C.



SS

**Infrared lamp**

Lampada ad infrarossi  
Infrarot Wärmebrücke  
Lampe infrarouge  
Lámpara infrarrojos

| art.     | GN  | cm.       | kW   |
|----------|-----|-----------|------|
| 49993-01 | 1/1 | 38x53x70  | 0,25 |
| 49993-02 | 2/1 | 70x53x71  | 0,50 |
| 49993-03 | 3/1 | 103x53x70 | 0,75 |

**Curved plexiglass fender.** – Parafiato in plexiglass curvo.



SS

**Warming plate**

Piano caldo  
Wärmeplatte  
Plaque chauffante  
Placa caliente

| art.     | GN  | cm.      | kW   |
|----------|-----|----------|------|
| 49993-11 | 1/1 | 33x53x6  | 0,25 |
| 49993-12 | 2/1 | 66x53x6  | 0,50 |
| 49993-13 | 3/1 | 132x53x6 | 0,75 |

**Adjustable thermostat +30°C +90°C.** – Termostato regolabile +30°C +90°C.



SS

**Table with hot box**

Tavolino con box termico  
Tisch mit Hot Box  
Table avec hot box  
Carrito con hot box

| art.     | Ø cm.   | h. cm. | W   |
|----------|---------|--------|-----|
| 44094-02 | 90/54,6 | 77     | 500 |

**Table with fold down flaps.** – Tavolo con flaps pieghevoli.





SS

**Table with hot box**

Tavolino con box termico  
Tisch mit Hot Box  
Table avec hot box  
Carrito con hot box

| art.     | Ø cm.   | h. cm. | W   |
|----------|---------|--------|-----|
| 44094-04 | 90/54,6 | 78,6   | 500 |

**Table with fold down flaps. With capsizable top for stacking when not in use.**  
Tavolo con flaps pieghevoli. Ribaltabile e impilabile quando non in uso.



SS

**Table with hot box**

Tavolino con box termico  
Tisch mit Hot Box  
Table avec hot box  
Carrito con hot box

| art.     | Ø cm. | h. cm. | W   |
|----------|-------|--------|-----|
| 44094-06 | 90/73 | 76     | 500 |

**Table with fold down flaps. Foldable for saving space when not in use. – Tavolo con flaps pieghevoli. Pieghevole per ridurre l'ingombro quando non in uso.**



**Mixer/liquidiser combi unit**

Combi mixer/frusta  
Kombigerät  
Combiné mixeur-fouet  
Brazo triturador/batidor, unidad combinada

| art.     | h. cm. | Kg.  | kW   | rpm   |
|----------|--------|------|------|-------|
| 49907-01 | 79     | 4,95 | 0,35 | 15000 |

**For containers up to 100 liters. – Per contenitori fino a 100 litri.**



**Liquidiser**

Mixer  
Stabmixer  
Mixeur  
Brazo triturador

| art.     | h. cm. | Kg.  | kW   | rpm   |
|----------|--------|------|------|-------|
| 49907-06 | 55,5   | 1,45 | 0,25 | 15000 |

**For containers up to 30 liters. – Per contenitori fino a 30 litri.**



**Wall rack**

Supporto murale  
Wandständer  
Support mural  
Soporte mural

| art.     |
|----------|
| 49907-AA |



**Liquidiser**

Mixer  
Stabmixer  
Mixeur  
Brazo triturador

| art.     | Kg. | kW  | rpm     |
|----------|-----|-----|---------|
| 49807-00 | 1   | 0,2 | 0-13000 |





**Mini mixer**  
Mini mixer  
Mini-Stabmixer  
Mini mixeur  
Mini batidora

| art.     | h. cm. | Kg.  | kW   | rpm         |
|----------|--------|------|------|-------------|
| 49808-00 | 40     | 0,78 | 0,45 | 12500:14000 |



**Liquidiser**  
Mixer  
Stabmixer  
Mixeur  
Brazo triturador

| art.     | h. cm. | Kg. | kW   | rpm        |
|----------|--------|-----|------|------------|
| 49911-24 | 24     | 1,4 | 0,27 | 2000:12500 |
| 49916-25 | 25     | 3,0 | 0,27 | 2300:9600  |
| 49916-35 | 35     | 3,3 | 0,35 | 2300:9600  |
| 49916-45 | 45     | 4,9 | 0,44 | 1500:9000  |
| 49916-55 | 55     | 5,2 | 0,75 | 9000       |



**Mixer/liquidiser combi unit**  
Combi mixer/frusta  
Kombigerät  
Combiné mixeur-fouet  
Brazo triturador/batidor, unidad combinada

| art.     | h. cm. | Kg. | kW   | rpm        |
|----------|--------|-----|------|------------|
| 49911-19 | 19     | 1,9 | 0,25 | 2000:12500 |
| 49911-30 | 30     | 3,1 | 0,30 | 2300:9600  |
| 49911-35 | 35     | 5,9 | 0,44 | 1500:9000  |
| 49911-45 | 45     | 6,1 | 0,50 | 1500:9000  |



**Juice extractor J80 Ultra**  
Centrifuga  
Fruchtpresse  
Centrifugeur-presse agrumes  
Centrifugadora/exprimidor jugos

| art.     | cm.          | kg./H | Kg. | kW  | rpm  |
|----------|--------------|-------|-----|-----|------|
| 49949-20 | 23,5x42x50,5 | 60    | 11  | 0,7 | 3000 |



**Vegetable preparation machine CL 50 Ultra**  
Tagliaverdure  
Gemüseschneidmaschine  
Coupe-légumes  
Cortador verduras

| art.     | cm.        | Kg. | kW   | rpm |
|----------|------------|-----|------|-----|
| 49940-01 | 30x36x55,5 | 15  | 0,55 | 375 |

**Suitable also for cutting mozzarella. For cutting discs contact our customer service.** – Ideale anche per tagliare mozzarella. Per i dischi di taglio contatta il ns customer service.



**Cutter & vegetable slicer R301 Ultra**  
Combinato cutter/tagliaverdure  
Gemüseschneid/- u. Schälmachine  
Cutter/Coupe-légumes  
Cortador verduras

| art.     | cm.        | lt. | Kg. | kW   | rpm  |
|----------|------------|-----|-----|------|------|
| 49942-01 | 28,5x36x40 | 3,7 | 14  | 0,65 | 1500 |

**For cutting discs contact our customer service.** Per i dischi di taglio contatta il ns customer service.





**Cutter & vegetable slicer R502 VV**

Combinato cutter/tagliaverdure  
Gemüseschneid/- u. Schälmaschine  
Cutter/Coupe-légumes  
Cortador verduras

| art.     | cm.          | lt. | Kg. | kW  | rpm      |
|----------|--------------|-----|-----|-----|----------|
| 49942-03 | 35,5x30x65,5 | 5,5 | 30  | 1,3 | 300-3500 |

**For cutting discs contact our customer service.**  
Per i dischi di taglio contatta il ns customer service.



**Table-top cutter R4**

Cutter da tavolo  
Gemüseschneidmaschine  
Cutter à légumes  
Cortador verduras

| art.     | cm.      | lt. | Kg. | kW  | rpm       |
|----------|----------|-----|-----|-----|-----------|
| 49943-01 | 21x32x43 | 4,5 | 17  | 0,9 | 1500/3000 |



**Table-top cutter R5 plus**

Cutter da tavolo  
Gemüseschneidmaschine  
Cutter à légumes  
Cortador verduras

| art.     | cm.      | lt. | Kg. | kW  | rpm       |
|----------|----------|-----|-----|-----|-----------|
| 49943-02 | 28x34x48 | 5,5 | 24  | 1,2 | 1500/3000 |



**Emulsifier-mixer Blixer 4**

Omogeneizzatore  
Mixergerät  
Emulsionneur-mixer  
Omogenizador/emulsificador

| art.     | cm.          | lt. | Kg. | kW | rpm       |
|----------|--------------|-----|-----|----|-----------|
| 49944-01 | 46x22,5x30,5 | 4,5 | 18  | 1  | 1500/3000 |



**Emulsifier-mixer Blixer 4 VV**

Omogeneizzatore  
Mixergerät  
Emulsionneur-mixer  
Omogenizador/emulsificador

| art.     | cm.          | lt. | Kg. | kW  | rpm      |
|----------|--------------|-----|-----|-----|----------|
| 49944-02 | 46x22,5x30,5 | 4,5 | 18  | 1,1 | 300-3500 |



**Sieving juicer C80**

Centrifuga  
Passiermaschine  
Centrifugeuse  
Centrifugadora

| art.     | cm.      | kg./H | Kg. | kW   | rpm  |
|----------|----------|-------|-----|------|------|
| 49946-01 | 61x36x54 | 50    | 21  | 0,65 | 1500 |



**Citrus fruit squeezer**

Spremiagrumi  
Zitruspresse  
Presse agrumes  
Exprimidor cítricos

| art.     | cm.      | Kg. | kW   | rpm  |
|----------|----------|-----|------|------|
| 49922-01 | 20x30x35 | 5   | 0,13 | 1500 |

**Citrus fruit squeezer**

Spremiagrumi  
Zitruspresse  
Presse agrumes  
Exprimidor cítricos

| art.     | cm.          | Kg. | kW   | rpm       |
|----------|--------------|-----|------|-----------|
| 49922-02 | 20,5x30,5x49 | 10  | 0,23 | 1500-1800 |

**Citrus fruit squeezer**

Spremiagrumi  
Zitruspresse  
Presse agrumes  
Exprimidor cítricos

| art.     | cm.      | Kg. | kW   | rpm       |
|----------|----------|-----|------|-----------|
| 49922-03 | 20x30x38 | 10  | 0,23 | 1500-1800 |

**Citrus fruit squeezer**

Spremiagrumi  
Zitruspresse  
Presse agrumes  
Exprimidor cítricos

| art.     | cm.      | Kg. | kW    | rpm       |
|----------|----------|-----|-------|-----------|
| 49922-04 | 24x40x49 | 10  | 0,275 | 1500-1800 |

**Juice extractor**

Centrifuga, spremisucchi  
Fruchtpresse  
Centrifugeur-presse agrumes  
Centrifugadora/exprimidor jugos

| art.     | cm.      | Kg. | kW  | rpm       |
|----------|----------|-----|-----|-----------|
| 49922-06 | 26x47x45 | 16  | 0,8 | 3000-3300 |





**Ice crusher**

Spaccaggiaccio  
Eiszerstosser  
Broyeur à glace  
Triturador de hielo

| art.     | cm.      | Kg. | kW   | rpm   |
|----------|----------|-----|------|-------|
| 49922-08 | 24x35x47 | 10  | 0,13 | 73-89 |



**Drink Mixer**

Frullino  
Getränkemixer  
Shaker électrique  
Batidora para batidos

| art.     | cm.      | Kg. | kW   | rpm        |
|----------|----------|-----|------|------------|
| 49949-09 | 18x18x53 | 6   | 0,12 | 8000-16000 |



**Blender**

Frullatore  
Getränkemixer  
Mixeur  
Batidora de vaso

| art.     | cm.        | lt. | Kg. | kW  | rpm       |
|----------|------------|-----|-----|-----|-----------|
| 49922-22 | 30x22x56,6 | 2   | 11  | 1,2 | 500-15000 |
| 49922-23 | 30x22x56,6 | 4   | 11  | 1,2 | 500-15000 |

**Stainless steel bowl. – Bicchiere inox.**



**Blender**

Frullatore  
Getränkemixer  
Mixeur  
Batidora de vaso

| art.     | cm.        | lt. | Kg. | kW  | rpm       |
|----------|------------|-----|-----|-----|-----------|
| 49922-20 | 30x22x56,6 | 2   | 11  | 1,2 | 500-15000 |
| 49922-21 | 30x22x56,6 | 4   | 11  | 1,2 | 500-15000 |

**Clear bowl BPA Free. – Bicchiere trasparente BPA Free.**



**Blender**

Frullatore  
Getränkemixer  
Mixeur  
Batidora de vaso

| art.     | cm.      | Kg. | kW |
|----------|----------|-----|----|
| 49922-09 | 20x47x44 | 9   | 3  |

**Clear bowl BPA Free. – Bicchiere trasparente BPA Free.**



**Citrus fruit squeezer**

Spremiagrumi  
Zitruspresse mit Spritzschutz  
Presse agrumes  
Exprimidora

| art.     | cm.      | Kg. | kW  | rpm  |
|----------|----------|-----|-----|------|
| 49958-00 | 31x22x34 | 8   | 0,3 | 1400 |





**Lever citrus fruit squeezer**

Spremiagrumi a leva  
Zitruspresse mit Pressarm  
Presse agrumes à levier  
Exprimidora

| art.     | cm.      | Kg. | kW   | rpm  |
|----------|----------|-----|------|------|
| 49959-00 | 31x22x35 | 9   | 0,34 | 1400 |

**Blender**

Frullatore  
Getränkemixer  
Mixeur

Batidora de vaso

| art.     | cm.      | lt. | Kg. | kW  | rpm         |
|----------|----------|-----|-----|-----|-------------|
| 49956-01 | 20x20x46 | 1,7 | 4   | 0,4 | 10000;15000 |

**Plastic bowl. – Bicchieri plastica.****Blender**

Frullatore  
Getränkemixer  
Mixeur

Batidora de vaso

| art.     | cm.      | lt. | Kg. | kW | rpm         |
|----------|----------|-----|-----|----|-------------|
| 49957-00 | 23x23x52 | 3   | 5,5 | 1  | 12000;22000 |

**Stainless steel bowl. – Bicchieri inox.****Automatic ice crusher**

Tritagiaccio automatico  
Eiszerstosser  
Broyeur à glace

Triturador de hielo automatico

| art.     | cm.      | Kg. | kW   | rpm  |
|----------|----------|-----|------|------|
| 49960-00 | 42x21x29 | 11  | 0,34 | 1400 |

**Drink mixer**

Frullino  
Getränkemixer  
Shaker électrique  
Batidora para batidos

| art.     | cm.      | lt. | Kg. | kW   | rpm   |
|----------|----------|-----|-----|------|-------|
| 49955-01 | 20x22x50 | 0,8 | 2,8 | 0,12 | 15000 |

**Plastic bowl. – Bicchieri plastica.****Rice steamer**

Cuoci riso a vapore  
Reiskocher  
Cuit riz

Hervidor de arroz

| art.     | Ø cm. | h. cm. | lt. | kW |
|----------|-------|--------|-----|----|
| 49954-21 | 5,0   | 35     | 21  | 3  |





SS

**Steamer**

Vaporiera  
Dampfer  
Cuit vapeur  
Olla para cocinar al vapor

| art.     | Ø cm. | h. cm. | lt. | kW |
|----------|-------|--------|-----|----|
| 49954-18 | 3,8   | 46     | 15  | 2  |



SS

**Water boiler**

Bollitore per acqua  
Wasser-Kessel  
Chauffe-eau  
Caldera

| art.     | Ø cm. | h. cm. | lt. | Kg. | kW  |
|----------|-------|--------|-----|-----|-----|
| 49954-20 | 4,7   | 48     | 20  | 5,7 | 2,1 |



**Planetary mixer**

Impastatrice planetaria  
Knet- u. Schlagmaschine  
Batteur-mélangeur  
Batodira planetaria

| art.     | cm.      | lt. | Kg. | kW   | rpm  |
|----------|----------|-----|-----|------|------|
| 49947-08 | 30x40x58 | 7,6 | 27  | 0,18 | 1420 |

**3 speeds. Timer 0-15 min. – 3 velocità. Timer 0-15 min.**



**Planetary mixer**

Impastatrice planetaria  
Knet- u. Schlagmaschine  
Batteur-mélangeur  
Batodira planetaria

| art.     | cm.        | lt. | Kg. | kW   | rpm    |
|----------|------------|-----|-----|------|--------|
| 49945-05 | 38x31x45,5 | 5   | 15  | 0,75 | 40>260 |

**10 speeds. – 10 velocità.**



SS

**Microwave oven - PROG**

Forno microonde  
Mikrowelle  
Four à micro-ondes  
Microonda

| art.     | cm.            | lt. | Kg. | kW  |
|----------|----------------|-----|-----|-----|
| 49997-12 | 54,2x46,1x32,9 | 30  | 18  | 1,6 |

**5 power levels. Time key X2. Digital timer. 3 cooking stages, 5 power levels. 10 programmable keys. 20 programs. – 5 livelli di potenza, da 200 a 1000W. Tasto tempo X2. Timer digitale. 3 stadi cottura e 5 livelli di potenza. 10 tasti programmabili. 20 programmi.**



SS

**Microwave oven - SELF**

Forno microonde  
Mikrowelle  
Four à micro-ondes  
Microonda

| art.     | cm.            | lt. | Kg. | kW  |
|----------|----------------|-----|-----|-----|
| 49997-13 | 54,2x46,1x32,9 | 30  | 18  | 1,6 |

**Time key X2. Digital timer. "START" button preprogrammed "1 minute" at full power. Parameters customizable. – Tasto tempo X2. Timer digitale. Tasto "START" pre-programmato "1 minuto" a piena potenza. Parametri pre-impostati personalizzabili.**



**Sous-vide cooking device**

Apparecchio per cottura sottovuoto

Sous-Vide Garer

Cuiseur bain marie - sous vide

Equipo para cocinar al vacío

| art.     | cm.        | lt. | Kg. | kW   |
|----------|------------|-----|-----|------|
| 49954-22 | 36x29,2x29 | 11  | 5,9 | 0,85 |

**Cooks food in vacuum-sealed pouches submerged in a water bath held at a precisely-controlled temperature from 30°C to 100°C.** – Per cuocere a bagnomaria in buste sottovuoto. La temperatura è mantenuta precisamente costante e può essere regolata da 30°C a 100°C.

**Sous-vide water bath**

Apparecchio per cottura sottovuoto

Sous-Vide Garer

Cuiseur bain marie - sous vide

Equipo para cocinar al vacío

| art.     | cm.      | lt. | Kg. | kW  |
|----------|----------|-----|-----|-----|
| 49952-08 | 22x25x38 | 8   | 4   | 0,8 |

**LED touch screen controls. The temperature can be set between 30 and 90°C and time between 0 and 99 hours. Stainless steel lid and wire rack included.** Controlli touchscreen a LED. La temperatura può essere impostata tra 30 e 90°C, tempo tra 0 e 99 ore. Coperchio e griglia in acciaio inossidabile inclusi.

**Soft cooker**

Apparecchio per cottura sottovuoto

Sous-Vide-Garer

Thermoplongeur

Máquina para cocinar al vacío

| art.     | cm.          | Kg. | kW  |
|----------|--------------|-----|-----|
| 49851-10 | 16,4x22x41,5 | 8   | 0,2 |

**Stainless steel structure. Suitable for containers up to 60 liters. Min. height of the tank 180 mm, electronic temperature control with 1/10°C precision, adjustable temperature 0>95°C. Pump for water circulation. Acoustic timer. Possibility to memorize up to 20 programs. Level sensor for lack of water.**

Struttura in acciaio inox. Per recipienti fino a 60 litri. Altezza minima del recipiente 180 mm, controllo elettronico della temperatura con precisione al 1/10°C, temperatura regolabile 0>95°C. Pompa per la circolazione dell'acqua. Timer acustico. Possibilità di memorizzare fino a 20 programmi. Sensore di livello per mancanza acqua.





**Induction cooker TC 3500**

Piastra ad induzione  
Induktionsplatte  
Plaque à induction  
Placa de inducción

| art.     | cm.        | Kg. | kW  |
|----------|------------|-----|-----|
| 49998-35 | 35,5x46x11 | 5,5 | 3,5 |

**Stainless steel body, Schott Ceran surface. Thermocontrol. 12 power levels. Temperature preselection 60-240°C. Timer 23 hours 59 min.**  
Corpo in acciaio inox, piano Schott Ceran. Thermocontrol. 12 livelli di potenza. Preselezione temperatura 60-240°C. Timer 23 ore 59'.



**Induction cooker**

Piastra ad induzione  
Induktionsplatte  
Plaque à induction  
Placa de inducción

| art.     | cm.      | Kg. | kW  |
|----------|----------|-----|-----|
| 18162-RA | 30x37x10 | 6   | 2,7 |

**Stainless steel body, Schott ceran surface. Timer 0-180 min. 10 power levels. Temperature range 60-240°C.** – Corpo inox, piano Schott ceran. Timer 0-180 min. 10 livelli di potenza. Temperatura 60-240°C.



**Induction cooker, to be built into counter**

Piastra ad induzione, da incasso  
Induktionsplatte, thekereinbau  
Plaque à induction, montage an comptoir  
Placa de inducción para emportar

| art.     | cm.        | Kg. | kW  |
|----------|------------|-----|-----|
| 18162-RB | 36X38x12,5 | 5,7 | 3,5 |

**Schott ceran surface. Timer 0-180 min. 10 power levels. Temperature range 60-240°C.** – Piano Schott ceran. Timer 0-180 min. 10 livelli di potenza. Temperatura 60-240°C.



**Induction cooker, to be built into counter**

Piastra ad induzione, da incasso  
Induktionsplatte, thekereinbau  
Plaque à induction, montage an comptoir  
Placa de inducción para emportar

| art.     | cm.         | Kg. | kW |
|----------|-------------|-----|----|
| 49998-20 | 35,5x35,5x6 | 3,4 | 2  |

**Schott ceran surface. 5 power levels. Temperature range 60-240°C.**  
Piano Schott ceran. 5 livelli di potenza. Temperatura 60-240°C.



SS

**Coffee percolator**

Percolatore per caffè  
Kaffee-Perkolator  
Percolateur à café  
Percolator de café

| art.     | Ø cm. | h. cm. | lt.  | W    |
|----------|-------|--------|------|------|
| 49846-05 | 28    | 38,5   | 4,5  | 950  |
| 49846-09 | 28    | 38,5   | 9,2  | 950  |
| 49846-15 | 33    | 54,0   | 15,0 | 1650 |



NEW

SS

**Samovar PYRAMID**

Samovar  
Samovar  
Samovar  
Samovar

| art.     | cm.          | lt.   | W    |
|----------|--------------|-------|------|
| 49856-04 | 35,5x30x45,2 | 4+1,2 | 2500 |

**Teapot with strainer. Cable length approx. 130 cm. With 2 heating elements 2000W and 500W.** – Teiera con colino. Lunghezza cavo circa 130 cm. Con 2 resistenze 2000W e 500W.





NEW

SS

**Samovar 2017**

Samovar  
Samovar  
Samovar  
Samovar

| art.     | cm.          | lt.   | W    |
|----------|--------------|-------|------|
| 49854-03 | 31x27,5x48,5 | 3+1,2 | 1500 |

**Teapot with strainer, cable length approx. 130 cm.**  
Teiera con colino. Lunghezza cavo circa 130 cm.



NEW

SS

**Samovar ROMANOV**

Samovar  
Samovar  
Samovar  
Samovar

| art.     | cm.      | lt.   | W    |
|----------|----------|-------|------|
| 49855-05 | 34x27x59 | 5+1,3 | 1800 |

**Teapot with strainer. Cable length approx. 100 cm. With 2 heating elements 1300W and 500W.** – Teiera con colino. Lunghezza cavo circa 100 cm. Con 2 resistenze 1300W e 500W.



NEW

SS

**Samovar 3006C**

Samovar  
Samovar  
Samovar  
Samovar

| art.     | cm.          | lt.   | W    |
|----------|--------------|-------|------|
| 49854-06 | 35,5x30x45,2 | 6+1,5 | 2500 |

**Teapot with strainer. With 2 heating elements 2000W and 500W.**  
Teiera con colino. Con 2 resistenze 2000W e 500W.



NEW

SS

**Samovar SORAYA**

Samovar  
Samovar  
Samovar  
Samovar

| art.     | cm.          | lt.    | W    |
|----------|--------------|--------|------|
| 49855-10 | 35,2x44,5x69 | 10+1,6 | 3000 |

**Teapot with strainer. Cable length approx. 130 cm. With 2 heating elements 2300W and 700W.** – Teiera con colino. Lunghezza cavo circa 130 cm. Con 2 resistenze 2300W e 700W.



NEW

SS

**Samovar KATHARINA**

Samovar  
Samovar  
Samovar  
Samovar

| art.     | cm.            | lt.  | W    |
|----------|----------------|------|------|
| 49855-15 | 39,5x44,5x74,5 | 15+2 | 3000 |

**Teapot with strainer. Cable length approx. 130 cm. With 2 heating elements 2300W and 700W.** – Teiera con colino. Lunghezza cavo circa 130 cm. Con 2 resistenze 2300W e 700W.



NEW

SS

**Chocolate fountain**

Fontana cioccolato  
Schokoladenbrunnen  
Fontaine à chocolat  
Fuente para chocolate

| art.     | Ø cm. | h. cm. | lt. | W   |
|----------|-------|--------|-----|-----|
| 42982-08 | 38    | 80     | 3,5 | 370 |

**230V-50Hz-Amps 1,6A. Minimum quantity of chocolate necessary for operation is about 3.5 kg, the maximum is 8 kg.** – Quantità minima di cioccolata richiesta per funzionare è di circa 3,5 kg e può contenerne fino a 8 kg.





**Soup kettle**

Zuppiera  
Suppenwärmer  
Marmite à soupe  
Olla de sopa

| art.     | Ø cm. | h. cm. | lt. | W       |
|----------|-------|--------|-----|---------|
| 49847-38 | 38    | 36,5   | 10  | 450-550 |



**Soup kettle**

Zuppiera  
Suppenwärmer  
Marmite à soupe  
Olla de sopa

| art.     | Ø cm. | h. cm. | lt. | W   |
|----------|-------|--------|-----|-----|
| 49847-08 | 33    | 37     | 10  | 400 |



**Raclette maker**

Macchina per raclette  
Raclette Tischgerät  
Appareil à raclette  
Máquina raclette

| art.     | cm.          | W   |
|----------|--------------|-----|
| 42420-06 | 44,5x21,5x30 | 850 |

**Foldable model with transport hook. 2 heating ramps, adjustable height. Suitable for cheese size 1/6 to 1/3 of a wheel. In stainless steel and painted steel. – Modello pieghevole con gancio di trasporto. 2 rampe di riscaldamento, altezza regolabile. Adatto per formaggi da 1/6 a 1/3 di una forma. In acciaio inossidabile e acciaio verniciato.**



**Raclette maker**

Macchina per raclette  
Raclette Tischgerät  
Appareil à raclette  
Máquina raclette

| art.     | cm.          | W   |
|----------|--------------|-----|
| 42420-08 | 44,5x21,5x30 | 850 |

**Tiltable and easily removable cheese holder. Heating block adjustable height. Ideal for 6-8 people, 1/2 shape. Cheese holder in stainless steel and epoxy painted steel structure. – Porta formaggio inclinabile e facilmente rimovibile. Blocco riscaldante regolabile in altezza. Ideale per 6-8 persone, 1/2 forma. Porta formaggio in acciaio inossidabile e struttura in acciaio verniciato epossidico.**



**Raclette maker, 4 pans**

Macchina per raclette, 4 padelle  
Raclette Tischgerät, 4 Pfannen  
Appareil à raclette, 4 poêlons  
Máquina raclette

| art.     | cm.      | W   |
|----------|----------|-----|
| 41318-00 | 51x10x12 | 600 |

**Non-stick upper plate for all cooking (vegetables, meats, etc.). Piastra superiore antiaderente per tutte le cotture (verdure, carne, ecc.).**



**Sugar lamp**

Lampada per zucchero  
Zuckerlampe  
Lampe à sucre  
Lámpara para azúcar

| art.     | cm.      | Kg. |
|----------|----------|-----|
| 47840-11 | 61x41x50 | 6,4 |

**Stainless steel. Infrared lamp, 3 selection powers 500-1000-1500W. Cable included. – Acciaio inox. Lampada infrarossi con 3 potenze selezionabili, 500-1000-1500W. Incl. cavo di alimentazione.**



**Spray gun**

Pistola  
Sprühpistole  
Pistolet  
Pistola

| art.     | ml. | Kg. | W  | rpm |
|----------|-----|-----|----|-----|
| 47848-07 | 700 | 1,1 | 60 | 280 |

**Usable for hot liquids max. 65 °C. Equipped with nozzle 0,6 mm.**  
Per liquidi caldi max. 65°C. Bocchetta in dotazione da 0,6 mm.

**Tempering unit**

Temperatrice  
Temperiergerät  
Tempereuse  
Templadora

| art.     | Ø cm. | h. cm. | lt. |
|----------|-------|--------|-----|
| 47698-01 | 20,5  | 21,2   | 1,7 |

**For ice cream parlours, ideal for chocolate coatings of ice creams on sticks. Can be used straight on the counter. Removable anodized aluminum tank.**  
Per gelaterie, ideale per coperture in cioccolato di gelati e semifreddi su stecco. Può essere utilizzato direttamente sul banco. Vasca estraibile in alluminio anodizzato.

**NEW**  
**ABS**

**Tempering unit**

Temperatrice  
Temperiergerät  
Tempereuse  
Templadora

| art.     | Ø cm. | h. cm. | lt. |
|----------|-------|--------|-----|
| 47698-02 | 26    | 16     | 1,8 |

**Mini dry melter, allows to process tiny chocolate quantities without any waste. Practical removable tank.** – Mini scioglitore a secco, adatto per piccole produzioni senza sprechi. Pratica vasca estraibile.

**NEW**  
**ABS**

**Tempering unit**

Temperatrice  
Temperiergerät  
Tempereuse  
Templadora

| art.     | cm.        | lt. |
|----------|------------|-----|
| 47698-03 | 40x24x13,5 | 3,6 |
| 47698-06 | 40x33x13,5 | 6,0 |

**Analog tempering units. Housing made with heat-resistant plastic. Removable stainless steel tank. UK/US/JAPAN/AUSTRALIA/CHINA wirings upon request.**  
Temperatrici analogiche. In materiale plastico termoresistente. Vasca inox removibile. Su richiesta cablaggio GB/USA/GIAPPONE/AUSTRALIA/CINA.

**SS**  
**ABS**

**Tempering unit, digital**

Temperatrice digitale  
Temperiergerät, digital  
Tempereuse digitale  
Templadora digital

| art.     | cm.        | lt. |
|----------|------------|-----|
| 47698-07 | 40x33x13,5 | 6,0 |

**Made of heat-resistant plastic material, stainless steel tank and lid, thermal probe for chocolate temperature control. Tempering manually adjustable or following the 3 programs depending on the type of chocolate: white, milk and dark.** – In materiale plastico termoresistente, vasca e coperchio in acciaio inox, sonda termica per la regolazione della temperatura del cioccolato. Temperaggio regolabile manualmente o seguendo i 3 programmi in base al tipo di cioccolato: bianco, al latte e fondente.

**NEW**  
**SS**  
**ABS**

**Airbrush compressor**

Compressore per penna aerografa  
Airbrush Kompressor  
Compresseur  
Compresor

| art.     | cm.      | W   |
|----------|----------|-----|
| 47844-06 | 16x30x23 | 200 |

**Cap. 4 bar.**





**Caramelizer**

Caramellizzatore  
Caramelisateur  
Carameliser-Eisen  
Carameliseur  
Quemador

| art.     | Ø cm. | W    |
|----------|-------|------|
| 47847-10 | 10    | 0,65 |
| 47847-12 | 12    | 1,00 |



**Caramelizer**

Caramellizzatore  
Caramelisateur  
Carameliser-Eisen  
Carameliseur  
Quemador

| art.     | l. cm. | W   |
|----------|--------|-----|
| 47847-23 | 23     | 1,5 |



**Meat mincer**

Tritacarne  
Fleischwolf  
Hachoir  
Tritador de carne

| art.     | cm.      | Kg. | kW   |
|----------|----------|-----|------|
| 49921-00 | 18x42x43 | 6   | 0,35 |



**Slicer**

Affettatrice  
Aufschnitt-Maschine  
Trancheur  
Cortadora

| art.      | Ø cm. | cm.        | Kg. | rpm |
|-----------|-------|------------|-----|-----|
| 49975-19  | 19,5  | 52x36x31,5 | 10  | 300 |
| 49975U19* | 19,5  | 52x36x31,5 | 10  | 300 |

\*Extra CE. Built-in blade sharpener. – Extra CE. Affilatoio fisso.



**Slicer**

Affettatrice  
Aufschnitt-Maschine  
Trancheur  
Cortadora

| art.      | Ø cm. | cm.        | Kg.  | rpm |
|-----------|-------|------------|------|-----|
| 49975-25  | 25    | 62x42,5x37 | 15,5 | 300 |
| 49975U25* | 25    | 62x42,5x37 | 15,5 | 300 |

\*Extra CE. Built-in blade sharpener. – Extra CE. Affilatoio fisso.



**Slicer**

Affettatrice  
Aufschnitt-Maschine  
Trancheur  
Cortadora

| art.      | Ø cm. | cm.        | Kg. | rpm |
|-----------|-------|------------|-----|-----|
| 49975-22  | 22    | 58x40,5x34 | 10  | 300 |
| 49975U22* | 22    | 58x40,5x34 | 10  | 300 |

\*Extra CE. Built-in blade sharpener. – Extra CE. Affilatoio fisso.







**Slicer**  
Affettatrice  
Aufschnitt-Maschine  
Trancheur  
Cortadora

| art.      | Ø cm. | cm.        | Kg. | rpm |
|-----------|-------|------------|-----|-----|
| 49975-30  | 30    | 65x49,5x44 | 23  | 300 |
| 49975U30* | 30    | 65x49,5x44 | 23  | 300 |

\*Extra CE. Built-in blade sharpener. – Extra CE. Affilatoio fisso.



**Slicer**  
Affettatrice  
Aufschnitt-Maschine  
Trancheur  
Cortadora

| art.      | Ø cm. | cm.        | Kg. | rpm |
|-----------|-------|------------|-----|-----|
| 49975-35  | 35    | 89x58,5x48 | 36  | 260 |
| 49975U35* | 35    | 89x58,5x48 | 36  | 260 |

\*Extra CE. Built-in blade sharpener. – Extra CE. Affilatoio fisso.



**Slicer**  
Affettatrice  
Aufschnitt-Maschine  
Trancheur  
Cortadora

| art.      | Ø cm. | cm.      | Kg. | rpm |
|-----------|-------|----------|-----|-----|
| 49974-25  | 25    | 53x52x50 | 24  | 300 |
| 49974U25* | 25    | 53x52x50 | 24  | 300 |

\*Extra CE. – Extra CE.



**Slicer**  
Affettatrice  
Aufschnitt-Maschine  
Trancheur  
Cortadora

| art.      | Ø cm. | cm.      | Kg. | rpm |
|-----------|-------|----------|-----|-----|
| 49974-30  | 30    | 53x52x50 | 27  | 300 |
| 49974U30* | 30    | 53x52x50 | 27  | 300 |

\*Extra CE. – Extra CE.





SS

**Sieve**

Passaverdura  
Passiergerät  
Moulin  
Molino

| art.     | Ø cm. | h. cm. | kg./H | Kg.  | W   |
|----------|-------|--------|-------|------|-----|
| 49879-37 | 37    | 108    | 300   | 23,5 | 600 |

**Threephase motor 380V. Disc 3 mm. – Motore trifase 380V. Griglia 3 mm.**



SS

**Can opener**

Apriscatole  
Dosenöffner  
Ouvre-boîte  
Abrelatas

| art.     | cm.      | Kg. |
|----------|----------|-----|
| 49814-00 | 44x25x75 | 13  |

**Dual speed motor. Opens all can shapes from 50 to 270 mm height. Motore a 2 velocità. Per formati scatola da 50 a 270 mm di altezza.**



SS

**Knife sterilizer**

Sterilizzatore per coltelli  
Messerentkeimer  
Armoire de sterilisation  
Esterilizador para cuchillos

| art.     | cm.        | W  |
|----------|------------|----|
| 49871-10 | 57,5x17x60 | 15 |

**Plexiglas door, magnetic lock. Timer setting from 0 up to 2 hours. Door with stop device when opening. Protection IP 24.**

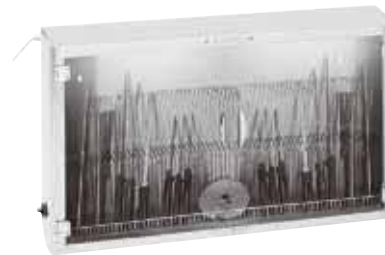

SS

**Knife sterilizer**

Sterilizzatore per coltelli  
Messerentkeimer  
Armoire de sterilisation  
Esterilizador para cuchillos

| art.     | cm.       | W  |
|----------|-----------|----|
| 49871-20 | 103x17x60 | 30 |

**Porta in plexiglas, chiusura magnetica. Programmabile da 0 a 2 ore. Dispositivo d'arresto all'apertura porta. Indice di protezione IP 24.**



**E**dlund

**Knife sharpener**

Affilacoltelli  
Messerschleifapparat  
Aiguiseur  
Afilador

| art.     | cm.      | Kg. | W   | rpm  |
|----------|----------|-----|-----|------|
| 49872-00 | 25x10x12 | 4   | 172 | 1550 |

**ABS knife guide. Pressure sensitive motor shuts down automatically. Guida in ABS estraibile. Motore con dispositivo autobloccante.**



**Knife sharpener**

Affilacoltelli  
Messerschleifapparat  
Aiguiseur  
Afilador

| art.     | cm.      | Kg. |
|----------|----------|-----|
| 49741-15 | 23x33x16 | 6,4 |
| 49741-07 | 23x16x16 | 4,6 |



# CUCINA SENZA GLUTINE

FOR GLUTEN-FREE COOKING



UNA LINEA COMPLETA DI ARTICOLI E STRUMENTI  
PROFESSIONALI FACILMENTE IDENTIFICABILI PER:

- diminuire il rischio di accidentali contaminazioni crociate degli alimenti;
- facilitare il professionista nell'operare e nell'offrire un servizio a favore del cliente con intolleranza al glutine;
- sensibilizzare il settore sul tema "gluten free" di fronte alle nuove esigenze dei consumatori.

A FULL LINE OF HORECA TOOLS AND ITEMS,  
EASY TO IDENTIFY, AIMED AT:

- reducing the risk of accidental food cross-contamination;
- making it easier for professionals to work and to provide services to clients with gluten intolerance;
- raising awareness on the gluten-free diet issue in the industry so as to respond to the new needs of consumers.



**Frypan**  
Padella

| art.     | Ø cm. |
|----------|-------|
| 11014F20 | 20    |
| 11014F24 | 24    |
| 11014F28 | 28    |
| 11014F32 | 32    |



**Cover**  
Coperchio

| art.     | Ø cm. |
|----------|-------|
| 11161F16 | 16    |
| 11161F20 | 20    |
| 11161F24 | 24    |
| 11161F28 | 28    |



**Baking sheet alusteel**  
Teglia forno, acciaio alluminato

| art.     | Ø cm. |
|----------|-------|
| 11739F20 | 20    |
| 11739F24 | 24    |
| 11739F28 | 28    |
| 11739F32 | 32    |



**Strainer with hook**  
Colapasta con manico e gancio

| art.     | Ø cm. |
|----------|-------|
| 11924F20 | 20    |



**Conical colander**  
Colapasta tronco conico

| art.     | Ø cm. |
|----------|-------|
| 11930F24 | 24    |





**One piece ladle**  
Mestolo unipezzo

| art.     | Ø cm. |
|----------|-------|
| 11970F06 | 6,5   |
| 11970F08 | 8,0   |
| 11970F10 | 10    |



**One piece skimmer**  
Schiumarola unipezzo

| art.     | Ø cm. |
|----------|-------|
| 11971F10 | 10    |
| 11971F12 | 12    |



**One piece perforated spatula**  
Paletta forata unipezzo

| art.     | Ø cm. |
|----------|-------|
| 11973F10 | 10    |
| 11973F12 | 12    |



**One piece basting spoon**  
Cucchiaione unipezzo

| art.     |
|----------|
| 11982F38 |



**Stock pot**  
Pentola alta

| art.     | Ø cm. |
|----------|-------|
| 12001F20 | 20    |
| 12001F24 | 24    |
| 12001F28 | 28    |



**Saucepot 2 handles**  
Casseruola alta 2 maniglie

| art.     | Ø cm. |
|----------|-------|
| 12007F16 | 16    |
| 12007F24 | 24    |
| 12007F28 | 28    |



**Colander for low stock pot**  
Colapasta per pentola bassa

| art.     | Ø cm. |
|----------|-------|
| 12123F20 | 20    |
| 12123F24 | 24    |
| 12123F28 | 28    |



**Wire whip, 8 wires**  
Frusta 8 fili

| art.     | l. cm. |
|----------|--------|
| 12928F30 | 30     |
| 12928F35 | 35     |



**Egg whisk, 11 wires**  
Frusta 11 fili



| art.     | l. cm. |
|----------|--------|
| 12929F30 | 30     |
| 12929F35 | 35     |



**Gastronorm Container**  
Bacinella gastronorm



| art.     | GN  | dim. cm.    |
|----------|-----|-------------|
| 14102F02 | 1/1 | 53x32,5x2   |
| 14102F04 | 1/1 | 53x32,5x4   |
| 14102F06 | 1/1 | 53x32,5x6,5 |
| 14102F10 | 1/1 | 53x32,5x10  |
| 14102F15 | 1/1 | 53x32,5x15  |
| 14102F20 | 1/1 | 53x32,5x20  |
| 14103F02 | 2/3 | 35,3x32x2   |
| 14103F04 | 2/3 | 35,3x32x4   |
| 14103F06 | 2/3 | 35,3x32x6,5 |
| 14103F10 | 2/3 | 35,3x32x10  |
| 14103F15 | 2/3 | 35,3x32x15  |
| 14103F20 | 2/3 | 35,3x32x20  |
| 14104F06 | 2/4 | 53x16,2x6,5 |
| 14104F10 | 2/4 | 53x16,2x10  |
| 14104F15 | 2/4 | 53x16,2x15  |
| 14105F02 | 1/2 | 32x26,5x2   |
| 14105F04 | 1/2 | 32x26,5x4   |
| 14105F06 | 1/2 | 32x26,5x6,5 |
| 14105F10 | 1/2 | 32x26,5x10  |
| 14105F15 | 1/2 | 32x26,5x15  |
| 14105F20 | 1/2 | 32x26,5x20  |
| 14107F06 | 1/3 | 32,5x18x6,5 |
| 14107F10 | 1/3 | 32,5x18x10  |
| 14107F15 | 1/3 | 32,5x18x15  |
| 14107F20 | 1/3 | 32,5x18x20  |
| 14108F06 | 1/4 | 26,5x16x6,5 |
| 14108F10 | 1/4 | 26,5x16x10  |
| 14108F15 | 1/4 | 26,5x16x15  |
| 14108F20 | 1/4 | 26,5x16x20  |
| 14109F06 | 1/6 | 17,6x16x6,5 |
| 14109F10 | 1/6 | 17,6x16x10  |
| 14109F15 | 1/6 | 17,6x16x15  |
| 14109F20 | 1/6 | 17,6x16x20  |
| 14110F06 | 1/9 | 17,6x11x6,5 |
| 14110F10 | 1/9 | 17,6x11x10  |



**Gastronorm cover**  
Coperchio gastronorm



| art.     | GN  |
|----------|-----|
| 14502F00 | 1/1 |
| 14503F00 | 2/3 |
| 14504F00 | 2/4 |
| 14505F00 | 1/2 |
| 14507F00 | 1/3 |
| 14508F00 | 1/4 |
| 14509F00 | 1/6 |
| 14510F00 | 1/9 |



**Bread knife**  
Coltello pane



| art.     | l. cm. |
|----------|--------|
| 18028F21 | 21     |
| 18028F25 | 25     |
| 18028F30 | 30     |
| 18028F36 | 36     |



**Pizza wheel**  
Rotella tagliapizza



art. 18324F10      Ø cm. 10



**Spatula perforated**  
Spatola pasticcio e pizza forata



art. 18510F07



**Pizza turner**  
Spatola per pasticcio e pizza



art. 18511F15



**Pastry spatula**  
Spatola per dolci



art. 18513F14



**Baking sheet alusteel**  
Teglia rettangolare, alluminata



|          |          |
|----------|----------|
| art.     | dim. cm. |
| 41751F30 | 30x23x3  |
| 41751F40 | 40x30x3  |
| 41751F60 | 60x40x3  |



**Cutting board**  
Tagliere



|          |     |           |      |
|----------|-----|-----------|------|
| art.     | GN  | dim. cm.  | col. |
| 42522F09 | 1/2 | 32x26,5x2 | ●    |



**Cutting board**  
Tagliere



|          |     |           |      |
|----------|-----|-----------|------|
| art.     | GN  | dim. cm.  | col. |
| 42538F09 | 1/1 | 53x32,5x2 | ●    |



**Cutting board**  
Tagliere



|          |          |      |
|----------|----------|------|
| art.     | dim. cm. | col. |
| 42539F09 | 60x40x2  | ●    |



**Bread tongs**  
Molla pane



art. 52550F63      l. cm. 23



**Spaghetti tongs**  
Molla spaghetti



art. l. cm.  
52550F73 21



**Toast-pastry tongs**  
Molla toast-dolci



art. l. cm.  
52550F78 24



**Cake pliers**  
Pinza torta



art. l. cm.  
52550F80 28



**Pastry pliers**  
Pinza dolci



art. l. cm.  
52550F88 18

**SPARE PARTS**  
RICAMBI



**Tap/Rubinetto : For/Per # 11102**

art.  
11102-99



**Roasting pan grid/Griglia brasiera : For/Per # 11965**

art. dim. cm.  
11966-50 50x30  
11966-60 60x35  
11966-61 61x43



**Clutch left, Asia rectangular/Frizione sx Asia rettangolare**

art.  
18132-KP



**Clutch right, Asia rectangular/Frizione dx Asia rettangolare**

art.  
18132-KQ



**Clutch right Asia /Frizione dx Asia**

art. Ø cm.  
18136-KQ 33-40



**Clutch left, Asia/Frizione sx Asia**

| art.     | Ø cm. |
|----------|-------|
| 18136-KP | 33    |
| 18136-KR | 40    |



**Clutch spring for rect. ABS, long side opening/Frizione molla ABS rett., apertura lato lungo**

| art.     |
|----------|
| 18162-AF |



**Clutch spring for rect. ABS, short side opening/Frizione molla ABS rett., apertura lato corto**

| art.     |
|----------|
| 18162-AG |



**Spare parts/Ricambi : For/Per # 58166A**

| art.     | des             | Ø cm. |
|----------|-----------------|-------|
| 18166-AD | Clutch/Frizione | 24    |
| 18166-AE | Clutch/Frizione | 36    |
| 18166-AF | Clutch/Frizione | 40    |
| 18166-AH | Clutch/Frizione | 30    |



**Spare parts/Ricambi : For/Per # 58172A54**

| art.     | des                          |
|----------|------------------------------|
| 18172-AF | Clutch spring/Frizione molla |



**Spare parts/Ricambi : For/Per # 58172A56**

| art.     | des                          |
|----------|------------------------------|
| 18172-AG | Clutch spring/Frizione molla |



**Spare parts/Ricambi : For/Per # 58176A**

| art.     | des   |
|----------|---|
| 18176-AE | Clutch for ABS Ø cm 36/Frizione ABS Ø cm 36 |
| 18176-AF | Clutch for ABS Ø cm 40/Frizione ABS Ø cm 40 |
| 18176-AH | Clutch for ABS Ø cm 30/Frizione ABS Ø cm 30 |



**Cutlery bag**  
Borsa porta coltelli

| art.     |
|----------|
| 18190-AA |





**Spare parts/Ricambi : For/Per # 18353-17**

| art.     | des                                |
|----------|------------------------------------|
| 18353-AA | Juice container/Contenitore succhi |
| 18353-BB | Tap/Rubinetto                      |
| 18353-CA | Lid/Coperchio                      |
| 18353-DB | Drip bowl/Ciotola raccogli gocce   |
| 18353-VA | Eutectic pad/Contenitore eutettico |



**Spare parts/Ricambi : For/Per # 19810-00**

| art.     | des                |
|----------|--------------------|
| 19810-AA | Blade/Lama         |
| 19810-AB | Gear/Ruota dentata |



**Spare porcelain/Ricambio porcellana : For/Per # 41311-00**

| art.     |
|----------|
| 41311-AA |



**Spare stand/Ricambio supporto : For/Per # 41311-00**

| art.     |
|----------|
| 41311-AB |



**Non slip feet/Piedini antiscivolo : For/Per # 41323**

| art.     | Pcs/Pz |
|----------|--------|
| 41323-AA | 6      |



**Folding lid/Coperchio a ribalta**

| art.     | Ø cm. |
|----------|-------|
| 41400-AB | 23,5  |
| 41405-AB | 13,5  |



**Cereal-bar glass/Barattolo cereali, vetro : For/Per # 42460-43; 42470-43**

| art.     | lt. |
|----------|-----|
| 41402-AA | 2   |



**Eutectic pad/Eutettico : For/Per # 41488**

| art.     | Ø cm. | h. cm. |
|----------|-------|--------|
| 41443-AE | 10,5  | 2      |



**Tray/Vassoio : For/Per # 41447-05**

art.  
41447-39



**Stoppers/Tappi pompa : For/Per # 41500-00**

art. Pcs/Pz  
41500-AA 2



**China cup/Porcellana : For/Per # 41563-07**

art.  
41563-AA



**China cup/Porcellana : For/Per # 41564-07,**

art.  
41564-AA



**Cheese jar/Vetro formaggiara : For/Per # 41638-01**

art.  
41638-91



**Spare parts/Ricambi : For/Per # 41638-02-04-12-13**

|          |   |
|----------|---|
| art.     | des                                     |
| 41638-92 | Oil/Winegar bottle/Ampolla olio/acetato |
| 41638-93 | Salt shaker/Vetro spargi sale           |
| 41638-94 | Pepper shaker/Vetro spargi pepe         |
| 41638-95 | Toothpick glass/Vetro porta stecchi     |



**Brush/Spazzola : For/Per # 41767-20**

art.  
41767-AA



**Euthetic pad/Eutettico tondo**

|          |       |        |
|----------|-------|--------|
| art.     | Ø cm. | h. cm. |
| 41910-AL | 15    | 2,5    |

**Spare parts/Ricambi : For/Per # 41911**



| art.     | des                   |
|----------|-----------------------|
| 41911-AA | Canister/Contentitore |
| 41911-AE | Slide SAN/Scivolo SAN |

**Cover/Tappo : For/Per # 42401**



| art.     |
|----------|
| 42401-AA |

**Cover/Tappo : For/Per # 42505**



| art.     |
|----------|
| 42405-AA |

**Set 10 blades/Set 10 lame : For/Per # 42520-00**



| art.     |
|----------|
| 42520-AA |

**Spare parts/Ricambi : For/Per # 42570-32**



| art.     | des              | mm. |
|----------|------------------|-----|
| 42570-91 | Disc/Griglia     | 1,5 |
| 42570-92 | Disc/Griglia     | 2,5 |
| 42570-94 | Disc/Griglia     | 4,0 |
| 42570-99 | Cranck/Manovella |     |

**Spare parts/Ricambi : For/Per # 42573-31**



| art.     | des              | mm. |
|----------|------------------|-----|
| 42573-91 | Disc/Griglia     | 1,5 |
| 42573-92 | Disc/Griglia     | 2,5 |
| 42573-94 | Disc/Griglia     | 4,0 |
| 42573-99 | Cranck/Manovella |     |

**Spare parts/Ricambi : For/Per # 42574-37**



| art.     | des              | mm. |
|----------|------------------|-----|
| 42574-90 | Disc/Griglia     | 1,0 |
| 42574-91 | Disc/Griglia     | 1,5 |
| 42574-92 | Disc/Griglia     | 2,0 |
| 42574-93 | Disc/Griglia     | 3,0 |
| 42574-94 | Disc/Griglia     | 4,0 |
| 42574-99 | Cranck/Manovella |     |

**Spare parts/Ricambi : For/Per # 42575-37**



| art.     | des              | mm. |
|----------|------------------|-----|
| 42575-90 | Disc/Griglia     | 1,0 |
| 42575-91 | Disc/Griglia     | 1,5 |
| 42575-92 | Disc/Griglia     | 2,0 |
| 42575-93 | Disc/Griglia     | 3,0 |
| 42575-94 | Disc/Griglia     | 4,0 |
| 42575-99 | Cranck/Manovella |     |



**Spare parts/Ricambi : For/Per # 42577-39**

| art.     | des              | mm. |
|----------|------------------|-----|
| 42577-90 | Disc/Griglia     | 1,0 |
| 42577-91 | Disc/Griglia     | 1,5 |
| 42577-92 | Disc/Griglia     | 2,0 |
| 42577-93 | Disc/Griglia     | 3,0 |
| 42577-94 | Disc/Griglia     | 4,0 |
| 42577-99 | Cranck/Manovella |     |



**Spare parts/Ricambi : For/Per # 42929-03**

| art.     | des                                   |
|----------|---------------------------------------|
| 42929-AA | Salt shaker/Vetro spargisale          |
| 42929-AB | Pepper shaker/Vetro spargipepe        |
| 42929-AC | Oil/Winegar bottle/Ampolla olio/aceto |



**Glass/Vetro : For/Per # 42939-15**

| art.     |
|----------|
| 42939-AA |



**Glass/Vetro lampada : For/Per # 42941-22**

| art.     |
|----------|
| 42941-AA |



**Wheel/Ruota : For/Per # 44023-00 # 44024-00**

| art.     |
|----------|
| 44023-AA |



**Dish separation grid /Griglia divisoria : For/Per # 44027-00**

| art.     |
|----------|
| 44027-AA |



**Eutectic pad/Piastra eutettica : For/Per # 44094R00**

| art.     | des         | dim. cm.  |
|----------|-------------|-----------|
| 44094-RE | Temp. -32°C | 13X23X3,5 |

**Sponge/Spugna : For/Per # 44101-03**



art.  
44101-AA

**Container/Contenitore : For/Per # 44103**



|          |         |
|----------|---------|
| art.     | des     |
| 44103-AA | 3 comp. |
| 44103-AB | 4 comp. |
| 44103-AC | 6 comp. |

**Flat mop/Frangia mop : For/Per # 44160-03**



art.  
44160-AA

**Trolley bags/Sacchi carrello : For/Per # 44174-24**



art.  
44174-AA

**Burner/Portacombustibile : For/Per # 44225-22; 44227-30**



art.  
44220-AA

**Cream puff nozzle/Beccuccio riempi bigne' : For/Per # 47612-01**



art.  
47612-AA

**Bone-saw blade/Lama per sega : For/Per # 48231**



|          |     |
|----------|-----|
| art.     | mm. |
| 48232-40 | 400 |
| 48232-45 | 450 |
| 48232-50 | 500 |

**Spare parts/Ricambi : For/Per # 49811-00**



|          |                            |
|----------|----------------------------|
| art.     | des                        |
| 49811-01 | Cutting knife kit/Kit lama |
| 49811-02 | Blade/Lama                 |

**Spare parts/Ricambi : For/Per # 49812-00**



|          |                                      |
|----------|--------------------------------------|
| art.     | des                                  |
| 49812-01 | Blade and wheel/Lama e ruota dentata |
| 49811-02 | Blade/Lama                           |

**Spare parts/Ricambi : For/Per # 49814-00**



|          |                                      |
|----------|--------------------------------------|
| art.     | des                                  |
| 49811-02 | Blade/Lama                           |
| 49814-01 | Blade and wheel/Lama e ruota dentata |



**Set 7 blades/Set 7 lame : For/Per # 49829-11**

art.  
49829-BA



**Spare parts/Ricambi : For/Per # 49830-60**

|          |                              |
|----------|------------------------------|
| art.     | des                          |
| 49830-00 | Slicer/Mandolino             |
| 49830-02 | Protective carriage/Carrello |
| 49830-AA | 38 Blades/Pettine 38 lame    |
| 49830-AB | 44 Blades/Pettine 44 lame    |
| 49830-AC | 60 Blades/Pettine 60 lame    |



**Spare parts/Ricambi : For/Per # 49832-10**

|          |                               |     |
|----------|-------------------------------|-----|
| art.     | des                           | mm. |
| 49832-80 | Pusher/Pressatore             | 10  |
| 49832-86 | Pusher/Pressatore             | 6   |
| 49832-88 | Pusher/Pressatore             | 8   |
| 49832-90 | Blade/Lama                    | 10  |
| 49832-96 | Blade/Lama                    | 6   |
| 49832-98 | Blade/Lama                    | 8   |
| 49832-99 | Carriage/Guida di scorrimento |     |



**Spare parts/Ricambi : For/Per # 49834-00**

|          |                              |
|----------|------------------------------|
| art.     | des                          |
| 49834-01 | Peeling blade/Lama a pelare  |
| 49834-02 | Slicing blade/Lama affettare |



**Spare parts/Ricambi : For/Per # 49835-00**

|          |                              |
|----------|------------------------------|
| art.     | des                          |
| 49835-01 | Peeling blade/Lama a pelare  |
| 49835-02 | Slicing blade/Lama affettare |



**Blade assembly/Set lame : For/Per # 49837-05**

art.  
49837-AA



**Blade assembly/Set lame : For/Per # 49838-08**

art.  
49838-AB



**Corkscrew worm/Verme cavatappi : For/Per # 49858-00**

art.  
49858-AA

**Grinding wheel assembly/Set ruota molatrice : For/Per # 49872-00**

art.  
49870-AA

**Disc/Griglia : For/Per # 49879-37**

| art.     | mm. |
|----------|-----|
| 49879-90 | 1,0 |
| 49879-91 | 1,5 |
| 49879-92 | 2,0 |
| 49879-93 | 3,0 |
| 49879-94 | 4,0 |

**Pedal & opening assembly/Pedaliera e movimento : For/Per # 49899-01**

art.  
49899-AA

**Glass/Bicchiere : For/Per # 49956-01**

art.  
49956-AA

**Display for fry pans/Espositore per padelle ferro**

art.  
XO1046

# **ALPHABETICAL INDEX**

## **INDICE ALFABETICO**



**A**

|                          |             |
|--------------------------|-------------|
| Absinthe spoon           | 310         |
| Acetate sheets           | 206         |
| Adaptor bar              | 60          |
| Agemono pot and stand    | 266         |
| Air pot                  | 432         |
| Airbrush                 | 196         |
| Airbrush compressor      | 196, 517    |
| Airtight cover for bowls | 424         |
| Almont past knife        | 181         |
| Angular spatula          | 79, 96      |
| Apple corer/wedger       | 88, 91, 115 |
| Apple peeler             | 115         |
| Apron, LDPE              | 169, 489    |
| Artichoke corer          | 116         |
| Ash shovel               | 272         |
| Ashtray                  | 372         |
| Asparagus peeler         | 87          |
| Asparagus tong           | 390         |
| Atomizer dash bottle     | 321         |
| Automatic dispenser      | 488         |
| Avocado peeler/slicer    | 117         |

**B**

|                                    |              |
|------------------------------------|--------------|
| Bag clip                           | 112, 192     |
| Baguette bread basket              | 416          |
| Bain-marie pot                     | 26, 31, 38   |
| Baking beans                       | 205          |
| Baking mat, silicone               | 204          |
| Baking paper                       | 204          |
| Baking sheet trolley               | 476-477      |
| Baking tray, aluminum              | 194, 282     |
| Baking tray, alusteel              | 194, 280-282 |
| Baking tray, non stick coated      | 195, 282     |
| Baking tray, perforated, aluminum  | 194, 282     |
| Baking tray, perforated, non stick | 282          |
| Baking tray, perforated, silicone  | 195, 205     |
| Baking tray, silicone coated       | 195, 205     |
| Balti pan                          | 266          |
| Bar items                          | 302-331      |
| Bar liner                          | 324          |
| Bar organizer                      | 320          |
| Bar runner                         | 324          |
| Barbecue brush                     | 103          |
| Barman apron                       | 325          |
| Barman's set                       | 325          |
| Base for ganache & frames          | 199          |
| Basket with wire stand             | 419          |
| Baster tube                        | 102          |
| Basting spoon                      | 100          |
| Basting spoon, one piece           | 98           |
| Beer glass                         | 313          |
| Bento box                          | 259          |
| Bento tray                         | 259          |
| Bike basket rack                   | 277          |
| Bird nest fryer                    | 100          |
| Biscuit spatula                    | 198          |
| Blender                            | 510-511      |
| Block brush                        | 165          |
| Board scraper                      | 167          |
| Bone-saw                           | 163          |
| Bordelais moulds                   | 38           |
| Boston shaker                      | 313          |

|  |                   |
|--|-------------------|
| Bottle cooler  | 367-368           |
| Bottle opener  | 86, 90, 330       |
| Bottle pourer  | 327-328           |
| Bottle rack wall mounting                            | 326               |
| Bottles/cans press                                   | 125               |
| Bouillon cloth                                       | 112               |
| Bourguignonne fondue set                             | 363               |
| Bowl double wall                                     | 434-435           |
| Bowl holder  | 424-426           |
| Bowl, BPA Free                                       | 296-298           |
| Bowl, glass  | 424               |
| Bowl, MF257-258, 350-351, 394-396, 399-402, 424, 426 |                   |
| Bowl, wood   | 337-338           |
| Box with lid   | 286, 294          |
| Bread basket   | 358, 414-420, 467 |
| Bread basket cover                                   | 418               |
| Bread basket stand                                   | 419               |
| Bread box  | 414               |
| Bread brush  | 255               |
| Bread canvas bag                                     | 358-359, 420      |
| Bread cutting board                                  | 414               |
| Bread mould  | 195, 254          |
| Bread proofing basket                                | 255               |
| Bread roll-dispenser                                 | 415               |
| Bread slicer   | 415               |
| Bread tong   | 80, 390           |
| Breadstick basket                                    | 361               |
| Breakfast tray with legs                             | 455               |
| Broom  | 483               |
| Broom & dust pan                                     | 482               |
| Brush for grill cleaning                             | 273               |
| Brussel sprout cutter                                | 116               |
| Bucket graduated                                     | 109, 485          |
| Buffet box   | 413-414           |
| Buffet display                                       | 405-406           |
| Buffet display items                                 | 393-449           |
| Buffet ladder  | 427-429           |
| Buffet stand   | 425-426, 429-430  |
| Butchers table                                       | 166               |
| Butter churn   | 122               |
| Butter cup   | 356               |
| Butter curler  | 87, 92            |
| Butter mould   | 122               |
| Butter spreader                                      | 85, 90, 391       |

**C**

|                            |                |
|----------------------------|----------------|
| Cake cooling tray          | 194            |
| Cake frames                | 207-209        |
| Cake marker                | 201            |
| Cake mould, non-stick      | 212-217        |
| Cake peel                  | 193            |
| Cake plate, swivel base    | 193            |
| Cake platter               | 289            |
| Cake ring, microperforated | 209            |
| Cake server                | 390            |
| Cake setting ring          | 207            |
| Cake slicer                | 198            |
| Cake stand                 | 288-289        |
| Cake tray                  | 288            |
| Can opener                 | 86, 90-91, 124 |
| Can opener electric        | 520            |
| Candelabra                 | 370            |
| Candleholder               | 370-371        |
| Candles led                | 411, 371       |

|                           |            |
|---------------------------|------------|
| Candlestick               | 369-370    |
| Canister                  | 26         |
| Canning jar set           | 333        |
| Cap, TNT                  | 169, 490   |
| Cappuccino milk pot       | 286        |
| Caps dispenser box        | 491        |
| Caramelising rod          | 196        |
| Caramelizer               | 518        |
| Card holder               | 371        |
| Cash tray                 | 287        |
| Caviar cooler             | 366        |
| Caviar flatware           | 366        |
| Ceddar/cheese grater      | 86         |
| Cereal bar                | 430        |
| Cereal dispenser          | 430-431    |
| Cereal pitcher            | 430        |
| Chafing dish stand        | 447        |
| Chafing dishes            | 436-443    |
| Chainmail apron           | 167        |
| Chainmail glove           | 167        |
| Chalkmarker               | 292, 420   |
| Champagne glass           | 303, 314   |
| Champagne saber           | 369        |
| Champagne stopper         | 328        |
| Champagne tong            | 369        |
| Champagne waterfall       | 408        |
| Changing table            | 480        |
| Charlotte comb            | 217        |
| Cheese cleaver            | 85, 89     |
| Cheese fondue set         | 363        |
| Cheese jar                | 361        |
| Cheese knife              | 84, 85, 89 |
| Cheese rotary grater      | 118        |
| Cheese shaker             | 361        |
| Cheese slicer             | 85, 89     |
| Chef's hat, TNT           | 169        |
| Chef's suitcase           | 158        |
| Chef's torch              | 197        |
| Cherry core stripper      | 119        |
| Chestnut knife            | 84         |
| Chinese colander          | 111        |
| Chinese hot pot           | 267        |
| Chinese kitchen scissors  | 268        |
| Chinese spoon             | 261        |
| Chocolate fountain        | 407, 515   |
| Chocolate mould, PC       | 222-229    |
| Chocolate mould, silicone | 221        |
| Chopstick rest            | 262        |
| Chopsticks                | 262, 269   |
| Christmas moulds          | 231        |
| Cigar ashtray             | 373        |
| Cigar humidor             | 373        |
| Cigar scissors            | 373        |
| Cinnamon shaker/mill      | 386        |
| Citrus fruit squeezer     | 509-511    |
| Citrus knife              | 87         |
| Clay pot                  | 267        |
| Cleaning & safety items   | 479-496    |
| Cleaning system, Pulse    | 482        |
| Cleaning wand             | 483        |
| Cleansing foam            | 488        |
| Clips for lids            | 71         |
| Cocktail fountain         | 407        |
| Cocktail glass            | 316        |
| Cocktail measuring cup    | 311        |

|                                 |              |                             |                    |                                |                         |
|---------------------------------|--------------|-----------------------------|--------------------|--------------------------------|-------------------------|
| Cocktail picks                  | 331          |                             |                    | Ethnic cuisine items           | 256-269                 |
| Cocktail spoon                  | 92, 309      | <b>D</b>                    |                    | Euronorm tray                  | 475                     |
| Cocktail strainer               | 310          | Dash bottle                 | 321-322            | Eutectic pad                   | 423, 470                |
| Cocoa dredger                   | 285          | Decorating combs            | 203                | Expanding pastry cutter        | 200                     |
| Cocoa stencils                  | 284          | Decorating knife            | 88, 92             | Extensible frame               | 207                     |
| Coffee measuring spoon          | 91           | Decorating spoons           | 106, 181           | External piping tip adapter    | 190                     |
| Coffee percolator               | 445, 514     | Decorating tips, ISI        | 300                |                                |                         |
| Coffee set                      | 287, 338     | Decoration tools            | 121                | <b>F</b>                       |                         |
| Coffee urn                      | 443          | Decorative scrapers         | 292                | Face masks                     | 489                     |
| Cognac warmer                   | 369          | Deep plate                  | 260                | Face shield                    | 489                     |
| Cola cup                        | 305          | Dehydrator                  | 503                | Farinata knife                 | 96                      |
| Colander                        | 108-109      | Dim Sum steam rack          | 265                | Fast food tray                 | 474                     |
| Collapsible frame               | 480          | Dipping forks               | 181, 364           | Finger-food, PR                | 343-344                 |
| Condiment holder                | 324          | Dish                        | 258                | Fish bone remover              | 102                     |
| Condiment set                   | 360-361      | Dish dolly                  | 463                | Fish kettle                    | 25, 31, 38              |
| Cone holder                     | 294-295      | Dish warmer                 | 502                | Fish scaler                    | 84-85, 89, 269          |
| Confectionery funnel            | 195          | Dispenser                   | 105-106            | Fish spatula, one piece        | 99                      |
| Conical colander                | 108          | Display for ice cream cones | 299                | Fish/chips spatula             | 80                      |
| Conical strainer                | 82, 89       | Display tray                | 163, 204           | Flair bottle                   | 320                     |
| Contact grill                   | 499          | Disposable baker's blades   | 255                | Flat plate                     | 260, 351                |
| Cookie cutter frame             | 219          | Disposable trolley covers   | 475                | Flavour marker                 | 293                     |
| Cookie press                    | 192          | Doilies                     | 193                | Flax seeds mill                | 386                     |
| Cooking tongs                   | 102-103      | Dolly                       | 466                | Floor sign 2-sided             | 484                     |
| Cookware, pots & pans 3-Ply     | 21-23, 434   | Dolly for cases             | 478                | Floor standing ashtray         | 488                     |
| Cookware, pots & pans aluminum  | 27-31, 39    | Dolly for insulated ctns    | 470                | Flour scoop                    | 107                     |
| Cookware, pots & pans cast iron | 41-48        | Dome cover                  | 288-289, 362       | Flour sifter                   | 203                     |
| Cookware, pots & pans copper    | 34-38        | Double sided tray           | 259                | Flower vase                    | 369                     |
| Cookware, pots & pans s/steel   | 44105        | Dough box                   | 279                | Foil cutter                    | 329                     |
| Cool bowl                       | 425          | Dough plunger cutters       | 180-181            | Folding ladder                 | 487                     |
| Cool showcase                   | 423          | Dough scrapers              | 278-279, 202-203   | Fondue set                     | 38                      |
| Cooler, PC                      | 315          | Drain tray                  | 466                | Food container                 | 465-466                 |
| Cotton mop                      | 483-484      | Drainer                     | 237                | Food pans for chafing dishes   | 447-448                 |
| Counter ice cream cone holder   | 293          | Drainer plate               | 60, 62, 64, 66, 69 | Foodloops                      | 113                     |
| Couscous pan                    | 28           | Draining rack               | 194, 463           | Foot pedal gel dispenser       | 490                     |
| Cover for bowls                 | 424, 426     | Dressing spoon              | 392                | Forehead infrared thermometer  | 489                     |
| Cream chargers, ISI             | 301          | Drink mixer                 | 510-511            | Fork                           | 93                      |
| Cream chargers, Kayser          | 300          | Duck fur pincer             | 268                | Forks, disposable              | 331                     |
| Cream dispenser                 | 195          | Dumplin maker               | 124                | Four-ways grater               | 123                     |
| Cream horn moulds               | 191          | Dunnage rack                | 487                | Frames pastry, plastic         | 218-219                 |
| Cream injector                  | 195          | Dust beater V sweeper       | 482                | Frames pastry, stainless steel | 218                     |
| Cream roll moulds               | 191          | Dust cover                  | 463                | French fry cutter              | 117                     |
| Cream whipper thermo, ISI       | 300          | Dustpan                     | 483                | French fry scoop               | 101                     |
| Cream whipper, ISI              | 300          |                             |                    | French press                   | 354                     |
| Cream whipper, Kayser           | 300          | <b>E</b>                    |                    | Fruit basket                   | 317, 357                |
| Crème brûlée bowl               | 50           | Easter moulds               | 231                | Fruit cutter                   | 114                     |
| Crème caramel mould             | 209          | Egg basket                  | 420                | Fruit decorating knife         | 88                      |
| Crepe machine                   | 500-501      | Egg boiler                  | 501                | Fruit scoop                    | 87                      |
| Crepe spreaders                 | 101          | Egg container               | 116                | Fruit stand                    | 407, 427                |
| Crockery transport box          | 464          | Egg cup                     | 356                | Fruit tong                     | 389                     |
| Croissant cutter                | 201          | Egg dish                    | 50                 | Fry basket                     | 60, 269                 |
| Cube cutter                     | 114          | Egg knocker                 | 116                | Fry dripping tray              | 25                      |
| Cup                             | 296-298      | Egg mould                   | 230                | Fry pan, non stick             | 12, 22, 29, 30, 40, 266 |
| Cut resistant glove             | 168          | Egg rings                   | 116                | Fry pan, steel                 | 33, 265-267             |
| Cutlery dispenser               | 361-362, 424 | Egg separator               | 92                 | Fry wire basket                | 33, 266                 |
| Cutlery holder                  | 461-462      | Egg slicer                  | 116                | Fryer                          | 501-502                 |
| Cutter turn'up                  | 119          | Egg wedger                  | 115                | Frying oil test strips         | 133                     |
| Cutter/corer                    | 119          | Electric appliances         | 497-520            | Fuel Holder                    | 448                     |
| Cutter/vegetable slicer         | 507-508      | Electric heating units      | 449                | Funnel                         | 104-105                 |
| Cutting board                   | 165-167      | Electric peeler             | 115, 503           | Funnel, ISI                    | 301                     |
| Cutting board rack              | 167          | Electric sieve              | 124                |                                |                         |
| Cutting roller                  | 200          | Emulsifier-mixer            | 508                | <b>G</b>                       |                         |
|                                 |              | Escargot dish               | 366                | Ganache frames                 | 199                     |
|                                 |              | Escargot fork               | 392                | Garlic press                   | 90, 118                 |
|                                 |              | Escargot picks              | 366                | Gastronorm basket              | 467                     |

|                               |                  |                               |                              |                             |                   |
|-------------------------------|------------------|-------------------------------|------------------------------|-----------------------------|-------------------|
| Gastronorm tray               | 475              | Ice cream server              | 291                          | Lanterns                    | 410               |
| Gel dispenser                 | 490              | Ice crusher                   | 510-511                      | Larding needled             | 161               |
| Glass cleaning brush          | 326              | Ice crusher                   | 318                          | Lasagne spatula             | 93, 96            |
| Glass clip holder             | 330              | Ice knife                     | 121                          | Lemon squeezer              | 317               |
| Glass rack                    | 326              | Ice pick                      | 318                          | Lemon striper               | 88, 92            |
| Glass rimmer                  | 324              | Ice scoop                     | 318                          | Lever corkscrew             | 329               |
| Glasses                       | 296-298          | Ice spoon                     | 318, 392                     | Lid for ice cream container | 291               |
| Glasses, Weck                 | 352-353          | Ice tea spoon                 | 310, 392                     | Lightning column            | 407               |
| Gloves                        | 169              | Ice tong                      | 320, 390                     | Liquidiser                  | 506-507           |
| Gloves dispenser box          | 490-491          | Ice tube mould                | 298                          | Lobster cracker             | 365               |
| Gloves disposable             | 489              | Ice-box                       | 422                          | Lobster fork                | 366               |
| GN food pans aluminum         | 59               | Ice-cream items               | 290-301                      | Lobster pick                | 365               |
| GN food pans enamelled        | 60               | Ice-dipper                    | 291                          | Log mold                    | 217               |
| GN food pans melamine         | 72-73            | Icing bag holder              | 193                          | <b>M</b>                    |                   |
| GN food pans non stick coated | 55               | Icing bags                    | 191-192                      | Magic spoon whisks          | 310               |
| GN food pans polycarbonate    | 61-62            | Icing bags/nozzles wall rack  | 193                          | Magnetic chocolate mould    | 228               |
| GN food pans polypropylene    | 65-71            | Induction adapter             | 110                          | Maki roll mould             | 263               |
| GN food pans porcelain        | 74-77            | Induction cooker              | 438, 514                     | Mandoline                   | 119               |
| GN food pans stainless steel  | 52-60            | Infrared lamp                 | 505                          | Manual sharpener            | 160               |
| GN food pans Tritan           | 63-64            | Injector needles, ISI         | 301                          | Margarita cup               | 303               |
| Gourmet bowl                  | 296              | Insulated beverage dispenser  | 472                          | Margarita glass             | 314, 317          |
| Gourmet tray                  | 296              | Insulated beverage server     | 354                          | Marinating syringe          | 102               |
| Grape scissor                 | 389              | Insulated containers          | 276, 469-472                 | Markers                     | 71                |
| Grapefruit knife              | 87, 91           | Insulated dispenser           | 432                          | Martini cup                 | 303               |
| Grater                        | 90, 118, 122-123 | Insulated sauce boat          | 356                          | Martini glass               | 314, 316          |
| Gravy boat                    | 357              | <b>J</b>                      |                              | Marzipan tools              | 181               |
| Grid enamelled                | 60               | Jam bar                       | 430                          | Masks dispenser box         | 491               |
| Grill stone table barbecue    | 364              | Japanese chopsticks           | 262                          | Measuring jug               | 105               |
| Guitar                        | 199              | Japanese jigger               | 311                          | Measuring pourer            | 327-328           |
| <b>H</b>                      |                  | Japanese omelettes pan        | 266                          | Measuring spoons/cups       | 105               |
| Ham stand                     | 163-164          | Jelly fuel                    | 449                          | Meat ball plier             | 81                |
| Ham tong                      | 162              | Juice dispenser               | 431-432                      | Meat cleaver                | 150-151           |
| Hamburger press               | 164              | Juice extractor               | 507-509                      | Meat fork                   | 94, 100, 153, 391 |
| Hamburger turner              | 96               | Juice glass                   | 313                          | Meat fork, one piece        | 98-99             |
| Hand hygiene station          | 488              | Juice pitcher                 | 354-355                      | Meat hook                   | 161               |
| Hand roll stand               | 260              | Julep mug                     | 306                          | Meat mincer                 | 518               |
| Hangiri/sushi rice tub        | 264              | Julep strainer                | 310                          | Meat pan                    | 163               |
| Hat pin for tickets           | 103              | <b>K</b>                      |                              | Meat tenderizer             | 162               |
| Heat accumulator              | 470              | Kaiser bread marker           | 255                          | Mechanical sweeper          | 482               |
| Heated showcase               | 502              | Kebab/Gyros grill             | 500                          | Melon baller                | 86, 91            |
| Herb mill                     | 124              | Kettle for mixing machines    | 110                          | Melon peeler                | 87                |
| Herb scissors                 | 117              | Kitchen bowl                  | 108                          | Menu stand                  | 371               |
| Herb/chili mill               | 384-385          | Kitchen scissors              | 154-155                      | Mesh skimmer                | 100               |
| Holder for blast chiller      | 298              | Kitchen tools wall rack       | 100                          | Microfibre cloths           | 484               |
| Honey/cream dispenser         | 285              | Kitchen utensils              | 78-136                       | Microfibre mops             | 482               |
| Hors-d'oeuvres plier          | 389              | Knife block                   | 159-160                      | Microwave oven              | 512               |
| Hot dog heater                | 500              | Knife rack                    | 160                          | Milk dispenser              | 431-432           |
| Housekeeping cart             | 481-482          | Knife roll-bag                | 159                          | Milk frothing thermometers  | 285               |
| Hydrometer for brine/salt     | 132              | Knife sanitizing system       | 160                          | Milk pot with lid           | 286               |
| Hygienic cover                | 414-415          | Knife sharpener electric      | 520                          | Mincing knife               | 152-153           |
| <b>I</b>                      |                  | Knife sterilizer              | 520                          | Mini push up pops           | 299               |
| Ice bucket                    | 320, 472         | Knives forged                 | 137-139                      | Minibar restocking cart     | 477               |
| Ice cart                      | 472              | Knives Japanese               | 156-157                      | Mini-guitar                 | 113               |
| Ice chisel                    | 121              | Knives stamped                | 140-153                      | Mint julep cup              | 305               |
| Ice cream basin               | 291              | <b>L</b>                      |                              | Mirror                      | 409-410           |
| Ice cream cake ring           | 206              | Labels solvable               | 133-134                      | Mixer/liquidiser combi unit | 506               |
| Ice cream container           | 291              | Ladle                         | 80-81, 92, 94, 100, 269, 391 | Mixing bowl                 | 38, 108, 110      |
| Ice cream counter display     | 298-299          | Ladle perforated, one piece   | 98                           | Mixing glass                | 313               |
| Ice cream cup                 | 295              | Ladle perforated, tube handle | 98                           | Mixing spoon                | 101               |
| Ice cream maker               | 503              | Ladle, one piece              | 98-99                        | Mobile pedal bin            | 486-487           |
| Ice cream mould               | 299              | Ladle, tube handle            | 98                           | Mobile plate rack           | 473               |
| Ice cream scoop               | 91, 292          |                               |                              | Moisture bottle             | 203               |
|                               |                  |                               |                              | Monoportion fork /spoon     | 392               |

|                            |               |                                  |                |                              |                   |
|----------------------------|---------------|----------------------------------|----------------|------------------------------|-------------------|
| Monoportion tray           | 220           | Pastry brush                     | 85, 90, 202    | Pumpkin mug                  | 303               |
| Mooncake mould             | 263           | Pastry cutters, PA+              | 180            | Punch bowl                   | 408               |
| Mop handles                | apr-01        | Pastry cutters, stainless steel  | 171-179        | PVC ribbon                   | 206               |
| Mop holder                 | 483           | Pastry moulds, silicone          | 232-253        | <b>QR</b>                    |                   |
| Mopping trolley w/press    | 484-485       | Pastry plier                     | 389            | Quenelle plier               | 81                |
| Mortar and pestle          | 268           | Pastry spatula                   | 96             | Raclette maker               | 363, 516          |
| Moscow mule mug            | 303-305       | Pastry stand                     | 287            | Rake                         | 272               |
| Mould for ice-balls        | 318-319       | Pastry tong                      | 80             | Ramekin                      | 50                |
| Mould for ice-cubes        | 319           | Pastry tube brush                | 190            | Rapid infusion kit, ISI      | 301               |
| Mould for ice-diamonds     | 319           | Pastry utensils                  | 170-255        | Reception bell               | 372               |
| Mould for ice-skulls       | 319           | Pastry wheel                     | 84, 88, 200    | Refrigerated box             | 457, 474          |
| Mousse ring                | 206           | Peel with handle                 | 274            | Refuse bag holder trolley    | 486               |
| Mozzarella/tomato cutter   | 113           | Peeler on stand                  | 114            | Resin spatula                | 103               |
| Muddler                    | 318           | Peeling heads                    | 114            | Retractable belt stanchion   | 495               |
| Multi rack                 | 428-429       | Pepper/salt mill                 | 377-387        | Revolving bottle rack        | 326               |
| Multifunction oven         | 501           | Perforated ladle                 | 81             | Revolving platter, AR        | 349               |
| Multipurpose box           | 463           | Perforated slice                 | 99             | Rice bowl, MF                | 257, 259          |
| Multipurpose tong          | 389           | Perforated spatula               | 81, 93-95      | Rice ladle                   | 391               |
| Mushroom cutter            | 117           | Perforated spoon                 | 80, 93-94, 100 | Rice scoop                   | 112               |
| Mussel pot                 | 365           | Petite marmite                   | 440            | Rice spoon                   | 93-94, 263        |
| Mustard cup                | 356           | Peugeot mills                    | 374-387        | Rice steamer                 | 511               |
| <b>N</b>                   |               | Pie knife                        | 85, 96         | Rice steamer shelf           | 265               |
| Napkin holder              | 287, 293, 362 | Pie plier                        | 389            | Roast beef knife             | 391               |
| Newspaper stick            | 372           | Pie server                       | 93             | Roasting pan                 | 25, 30-31, 38, 44 |
| Nigiri mould               | 263           | Piepens, aluminum                | 210            | Roasting pan with lid        | 434               |
| Nitro Whip, ISI            | 284           | Pineapple cup                    | 303            | Roll holder                  | 104, 475          |
| Noshikushi skewers         | 262, 330      | Pineapple peeler/corer           | 86, 114-115    | Rolling dough cutter         | 202               |
| Nozzles, PC                | 188-190       | Pinneapple slicer                | 115            | Rolling pin                  | 201               |
| Nozzles, PP                | 188           | Pizza cutter                     | 274            | Roll-top cover               | 288, 421-423      |
| Nozzles, s/steel one piece | 182-189       | Pizza delivery bag               | 277-278        | Room service table           | 457-458           |
| Nut cracker                | 365           | Pizza items                      | 270-282        | Room service tray            | 455               |
| Nutmeg grater              | 123           | Pizza knife                      | 84, 274        | Room-service trolleys        | 455-458           |
| Nutmeg mill                | 385-386       | Pizza ladle, flat bottom         | 81, 279        | Rubber comb wood effect      | 217               |
| <b>O</b>                   |               | Pizza oven brush                 | 272-273        | Ruler                        | 198               |
| Octopus-press              | 113           | Pizza pan rack                   | 280            | Runner                       | 347               |
| Oil pourer                 | 268, 271      | Pizza pan, blue steel            | 280-281        | <b>S</b>                     |                   |
| Oil/vinegar sprayer        | 360           | Pizza pan, non stick             | 280            | Safety chain for floor signs | 484               |
| Oil/winegar stand          | 361           | Pizza pan, perforated, non stick | 280            | Sake cup                     | 261               |
| Olive seed remover         | 118           | Pizza peel                       | 271-273        | Sake jug                     | 261               |
| Orange juicer              | 317           | Pizza peel rack                  | 273            | Sake warmer                  | 261               |
| Orange peeler              | 87, 91, 115   | Pizza plate w/wooden platter     | 275            | Salad bowl                   | 357, 398          |
| Oval dish                  | 397           | Pizza scissors                   | 274            | Salad fork                   | 92                |
| Oven mitts                 | 167-168       | Pizza screen                     | 280            | Salad spinner                | 111               |
| Overshoes                  | 169, 490      | Pizza screen rack                | 280            | Salad spoon                  | 93                |
| Oyster fork                | 392           | Pizza turner                     | 96             | Salad tong                   | 80                |
| Oyster knife               | 84, 90        | Pizza wheel                      | 84, 88, 274    | Salamanca                    | 500               |
| Oyster plate               | 366-367, 407  | Planetary mixer                  | 512            | Salami pricker               | 160               |
| Oyster/fruit stand         | 366           | Plate                            | 398, 401       | Salt spoon                   | 391               |
| <b>P</b>                   |               | Plate cover                      | 104            | Salt tester                  | 133               |
| Pallet                     | 487           | Plate spacer ring                | 104            | Salt/pepper mills            | 374-387           |
| Pan gripper                | 274           | Plate warmer                     | 364-365        | Salt/pepper shaker           | 360-361           |
| Panettone knife            | 390           | Platform cart                    | 478            | Samovar                      | 444-445           |
| Paper cap                  | 169, 489      | Platter                          | 400            | Sanitizing detergent, floor  | 484               |
| Paper Chef hat             | 169           | Platter with porcelain surface   | 339            | Sanitizing gel, hands        | 489               |
| Paring knife               | 89            | Pocket crumber                   | 363            | Sauce ladle                  | 92, 391           |
| Parmesan knife             | 85            | Portioning ring                  | 112            | Sauce pot wooden platter     | 340               |
| Parmesan spoon             | 391           | Potato fork                      | 91             | Sauce pourer                 | 260               |
| Parsley knife              | 84            | Potato masher                    | 89-90          | Sauce spoon                  | 100               |
| Party plate                | 395           | Potato peeler                    | 87, 91, 117    | Sausage filler               | 164               |
| Party spoon                | 397           | Potato ricer                     | 117            | Sausage tongs                | 102               |
| Party tub                  | 408           | Potato twist cutter              | 115            | Scales                       | 135-136           |
|                            |               | Poultry shears                   | 154            | Scoop                        | 267               |
|                            |               | Presse canard                    | 113            |                              |                   |
|                            |               | Pretzel stand                    | 414            |                              |                   |
|                            |               | Product list Gluten Free #       | 521-525        |                              |                   |

|                               |                        |                               |                             |                               |                   |
|-------------------------------|------------------------|-------------------------------|-----------------------------|-------------------------------|-------------------|
| Scrubbing gloves              | 168                    | Spatula                       | 79-81, 90, 93, 96, 101, 269 | Sweet box                     | 288               |
| Sea urchin cutter             | 365                    | Spatula perforated, one piece | 99                          | Swing table top waste bin     | 365               |
| Seafood display rack          | 366                    | Spatula, one piece            | 99                          | Swivel cake stand             | 288               |
| Segment colander              | 26                     | Spatzle sieve                 | 123                         | Swivel peeler                 | 91                |
| Self-standing guard           | 493                    | Speed rack                    | 103, 326                    | Swords                        | 161               |
| Serving basket sticky rice    | 264                    | Spiked roller                 | 200                         | Syrup density meter           | 132, 198          |
| Serving board, MF             | 400                    | Spiral vegetable slicer       | 120-121                     | Syrup density meter test tube | 198               |
| Serving board, wood           | 337-339                | Spits, disposable             | 331                         | <b>T</b>                      |                   |
| Serving fork                  | 390                    | Spoon                         | 79-81                       | Table bag holder              | 367               |
| Serving platter, MF           | 336-337                | Spoon and cup holder          | 294                         | Table barbecue                | 46, 364           |
| Serving platter, PL           | 335                    | Spoon case                    | 294                         | Table caddy                   | 362               |
| Serving plier                 | 389                    | Spoon crosswise, one piece    | 98                          | Table cigar cutter            | 373               |
| Serving spoon                 | 390-391                | Spoon holder                  | 286                         | Table crumbler                | 363               |
| Serving stand                 | 353, 394               | Spoon perforated, one piece   | 98                          | Table mat                     | 347               |
| Serving stand 2-tier          | 339, 349, 429          | Spoon, one piece              | 99                          | Table number stand            | 371               |
| Serving stand 3-tier          | 339, 429               | Spoons, disposable            | 331                         | Table sign                    | 371               |
| Serving tong                  | 80, 102-103, 389       | Spray gun                     | 196, 517                    | Table top can opener          | 126               |
| Serving trolley               | 476-477                | Spraying bottle               | 203                         | Table top service items       | 345-387           |
| Shaker                        | 311                    | Spring closure hook           | 496                         | Table with hot box            | 474               |
| Sharpening steel              | 153                    | Squeeze bottle                | 106                         | Table-cloth clips             | 362               |
| Sharpening stone              | 153                    | Stackable containers          | 467-468                     | Table-top cutter              | 503, 508          |
| Showcase                      | 287, 421-422           | Stanchion                     | 496                         | Tamagoyaki pan                | 266               |
| Side basting spoon            | 99                     | Stanchion sign holder         | 495                         | Tapas display                 | 503               |
| Side basting spoon, one piece | 98                     | Stand                         | 403                         | Tart ring                     | 206               |
| Sieve                         | 107, 203               | Stand/basket                  | 405                         | Tasting bowl                  | 341-342           |
| Sieve electric                | 520                    | Steam rack                    | 265                         | Tasting dish                  | 341-342           |
| Sieve on tripod               | 124                    | Steamer                       | 264, 267, 512               | Tasting glass                 | 341-342           |
| Sign holders                  | 420                    | Stencil for grating pastry    | 201                         | Tasting/dessert set           | 333-334           |
| Silicone sleeve               | 33, 44                 | Stencils                      | 221                         | Tawa pan                      | 267               |
| Silicone spoon                | 94                     | Step on bin                   | 485                         | Tea light led                 | 371               |
| Silicone turner               | 94                     | Stew pan with lid             | 434                         | Tea strainer                  | 356               |
| Sink trolley                  | 466                    | Sticky rice cooking set       | 264                         | Tea-box                       | 286               |
| Sizzler platter               | 267                    | Sticky rice lao basket        | 264                         | Telescopic door sign          | 484               |
| Skewers                       | 161                    | Sticky rice lao pot           | 264                         | Telescopic rod                | 483               |
| Skimmer                       | 80-81, 93-94, 100, 269 | Stirrers                      | 308-309                     | Tempering unit                | 197, 299-300, 517 |
| Skimmer, one piece            | 99-100                 | Stirring ladle                | 79                          | Tempura rack                  | 265               |
| Skull dash bottle             | 321                    | Stoneware                     | 40                          | Tepokushi skewers             | 262, 331          |
| Slicer                        | 164, 518-519           | Storage & transport           | 459-478                     | Thai knife                    | 121               |
| Slotted turner                | 100                    | Storage canister              | 323                         | Thermic hot box               | 457, 474          |
| Small bowl, PR                | 260-261                | Storage container             | 466                         | Thermo cover for plate rack   | 473               |
| Small dish, PR                | 260                    | Store & pour container        | 322-323                     | Thermohygrometer              | 132               |
| Smell-remover soap            | 92                     | Strainer                      | 82, 111-112                 | Thermometers                  | 127-133           |
| Smoker                        | 503                    | Strainer, giant               | 111                         | Thermoregulator               | 449               |
| Smoking gun                   | 321                    | Straw brush                   | 307                         | Tickets-holder                | 103-104           |
| Smoother                      | 198                    | Straw holder                  | 286                         | Tiki mug ceramic              | 307               |
| Snack holder                  | 332-333                | Straws                        | 307-308                     | Tiki skull glass              | 306               |
| Snail tong                    | 390                    | Straws case                   | 294                         | Tilt truck                    | 487               |
| Sneeze guard                  | 492-494                | String holder                 | 163                         | Timer                         | 132               |
| Soba choko cup                | 259                    | Sturdy chair                  | 480                         | Toast rack                    | 356               |
| Soda chargers, ISI            | 318                    | Sugar bulb                    | 197                         | Toast tong                    | 389               |
| Soda siphon, ISI              | 317                    | Sugar dredger                 | 203                         | Toaster                       | 498               |
| Soufflé pot                   | 47                     | Sugar gloves                  | 168                         | Toban skillet                 | 266               |
| Soup bowl                     | 357                    | Sugar lamp                    | 196, 516                    | Tomato cutter                 | 113               |
| Soup kettle                   | 445-446, 516           | Sugar packet holder           | 286                         | Tomato juicer sieve           | 124               |
| Soup plate                    | 351                    | Sugar pourer                  | 285                         | Tomato peeler                 | 87                |
| Soup spoon                    | 260                    | Sugar saucepan                | 38                          | Toothpicks                    | 331               |
| Soup strainer                 | 82, 89                 | Sugar thermometer holder      | 198                         | Tortillas cup                 | 47                |
| Sous vide foam tape           | 131                    | Sugar tong                    | 390                         | Tortillas wedger              | 118               |
| Sous-vide cooking device      | 513                    | Sugar/jam thermometer         | 197                         | Towel tray                    | 259               |
| Soy pot                       | 261                    | Sushi geta board              | 259                         | Tray stand                    | 411               |
| Space saving box              | 467                    | Sushi mat                     | 263                         | Tray with cover               | 299               |
| Spaghetti server              | 93-94, 391             | Sushi serving dish            | 259                         | Tray with dome cover          | 349               |
| Spaghetti spoon               | 100                    | Sushi tray                    | 396                         | Tray, AR                      | 348-349           |
| Spaghetti tong                | 80, 389                | Sushi-sashimi boat            | 260                         |                               |                   |
| Spare parts                   | 525-533                | Sushi-sashimi bridge          | 259                         |                               |                   |

|                        |   |                        |                     |
|------------------------|---|------------------------|---------------------|
| Tray, MF               | 257-258, 350-351, 395-396, 399, 402-404 | Wire cheese cutter     | 118                 |
| Tray, stainless steel  | 411-412                                 | Wire dish rack         | 463                 |
| Trivet                 | 44, 365                                 | Wire grid              | 60                  |
| Trolley Quick Cart     | 480                                     | Wire skimmer           | 101                 |
| Trolley, convertible   | 478                                     | Wire stand             | 419-420             |
| Trolleys, dining room  | 450-458                                 | Wok                    | 22, 33, 43, 264-265 |
| Trolleys, room-service | 455-458                                 | Wok brush              | 269                 |
| Truffle jar            | 359                                     | Wonton noodle skimmer  | 268                 |
| Truffle server         | 359                                     | Wooden service platter | 339-340             |
| Truffle-slicer         | 359                                     | Worktop                | 167                 |
| Tumbler                | 314-315                                 |                        |                     |
| Tweezer                | 309                                     |                        |                     |
| Twisted rope           | 496                                     |                        |                     |

## U

|                                  |         |
|----------------------------------|---------|
| Uncorking machine                | 329     |
| Universal box                    | 293     |
| Universal tray collector trolley | 475     |
| Utility rack GN pans             | 475-477 |

## V

|                               |          |
|-------------------------------|----------|
| Vacuum pump wine preserver    | 330      |
| Vegetable cutter              | 88, 114  |
| Vegetable preparation machine | 507      |
| Vegetable sharpener           | 85       |
| Vegetable sieve               | 111, 125 |
| Vegetable slicer              | 117      |
| Vegetables knife              | 84, 89   |
| Vegetables serving plier      | 389      |
| Vinyl bag                     | 481      |
| Visitor kit, TNT              | 169, 490 |
| Visitor's kit dispenser box   | 491      |

## W

|                             |                      |
|-----------------------------|----------------------|
| Waffle case                 | 294                  |
| Waffle iron                 | 504-505              |
| Waiter's corkscrew          | 329                  |
| Wall clock                  | 134                  |
| Wall film box               | 104                  |
| Warming plate               | 505                  |
| Wasabi grater               | 268                  |
| Wash racks                  | 460-461              |
| Wash racks dolly            | 462                  |
| Washable kraft paper bag    | 357                  |
| Waste container             | 485                  |
| Water boiler                | 512                  |
| Water jug                   | 316, 354-355         |
| Wedding cake stand          | 407                  |
| Wet sea salt mill           | 383-384              |
| Whipper heat protector, ISI | 301                  |
| Whisk                       | 100, 103, 82, 88, 94 |
| Whiskey glass               | 313-314              |
| Whistling kettle            | 25                   |
| Wine bucket                 | 367                  |
| Wine bucket table clip      | 367                  |
| Wine collar                 | 369                  |
| Wine cooler stand           | 367                  |
| Wine glass                  | 314                  |
| Wine holder                 | 369                  |
| Wine pourer                 | 369                  |
| Wine stopper                | 328                  |
| Wine taster                 | 369                  |
| Winged corkscrew            | 329                  |
| Wire basket, cotton linen   | 358                  |

## YZ

|                        |        |
|------------------------|--------|
| Y-shaped swivel peeler | 87, 91 |
| Zabaione bowl          | 38     |
| Zaru soba tray         | 259    |
| Zucchini corer         | 86, 91 |

**A**

|                                |                       |                                  |                  |   |                   |
|--------------------------------|-----------------------|----------------------------------|------------------|---|-------------------|
| Acciaino                       | 153                   | Benna ribaltabile                | 487              | Carrello ritiro vassoi universale                       | 475               |
| Accumulatore di caldo          | 470                   | Bicchiere acqua                  | 314-315          | Carrello teglie GN                                      | 475-477           |
| Accumulatore di freddo         | 423, 470              | Bicchiere cocktail               | 316              | Carrello trasporto materiali                            | 478               |
| Acetato in fogli               | 206                   | Bicchiere margarita              | 314, 317         | Carrello vasca  | 466               |
| Adattatore bocchette           | 190                   | Bicchiere martini                | 314, 316         | Carta da forno  | 204               |
| Adattatore induzione           | 110                   | Bicchiere miscelatore            | 313              | Cascata champagne                                       | 408               |
| Affetta formaggio              | 85, 89                | Bicchiere succo                  | 313              | Casseruola Agemono                                      | 266               |
| Affetta mozzarella/pomodori    | 113                   | Bicchiere vino                   | 314              | Casseruola terracotta                                   | 267               |
| Affettatrice                   | 164, 518-519          | Bicchiere whiskey                | 313-314          | Casseruola zabaione                                     | 38                |
| Affilacoltelli elettrico       | 520                   | Bicchierini                      | 296-298, 341-342 | Casseruola zucchero                                     | 38                |
| Affilacoltelli manuale         | 160                   | Bilance                          | 135-136          | Catenella sicurezza x cavalletti                        | 484               |
| Affumicatoio                   | 503                   | Boccale birra                    | 313              | Cavalletto di segnalazione                              | 484               |
| Affumicatore                   | 321                   | Bocchette, inox unipezzo         | 182-189          | Cavatappi cameriere                                     | 329               |
| Ago da cucina                  | 161                   | Bocchette, ISI                   | 300              | Cavatappi da parete                                     | 329               |
| Alzata 2 piani                 | 339, 349, 429         | Bocchette, PC                    | 188-190          | Cavatappi doppia leva                                   | 329               |
| Alzata 3 piani                 | 339, 429              | Bocchette, PP                    | 188              | Centrifuga manuale                                      | 111               |
| Alzata buffet                  | 403, 425-426, 429-430 | Bollitore                        | 25, 512          | Centrifuga succhi                                       | 507-509           |
| Alzata ceste pane              | 419                   | Bollitore uova                   | 501              | Ceppa   | 166               |
| Alzata dolci                   | 287                   | Bordatore bicchieri              | 324              | Ceppo   | 167               |
| Alzata frutta                  | 407                   | Borsa isoterma per pizza         | 277-278          | Ceppo porta coltelli                                    | 159-160           |
| Alzata frutti di mare          | 366                   | Bottiglia angostura              | 321-322          | Cesta baguettes   | 358, 416          |
| Alzata torta                   | 288-289, 407          | Box buffet                       | 413-414          | Cestelli lava bicchieri                                 | 460-461           |
| Alzata torta girevole          | 288                   | Box isoterma                     | 470-471          | Cestello per friggere                                   | 33, 60, 266       |
| Alzata/cesto                   | 405                   | Box portaghiaccio                | 422              | Cestello porta posate                                   | 461-462           |
| Anelli per uova                | 116                   | Box refrigerato                  | 457, 474         | Cestello portapacco bike                                | 277               |
| Anello distanziatore           | 104                   | Box termico                      | 474, 457         | Cestino agrumi  | 317               |
| Anello mousse                  | 206                   | Brasiera                         | 25, 31           | Cestino impasto   | 255               |
| Anello per impiattare          | 112                   | Bruschino per bocchette          | 190              | Cesto c/supporto in filo                                | 419               |
| Anello regolabile              | 207                   | Buffet e presentazione, articoli | 393-449          | Cesto frutta  | 357               |
| Anello torte                   | 206                   | Bustina carta                    | 169, 489         | Cesto gastronom   | 467               |
| Apparecchi elettrici           | 497-520               | <b>C</b>                         |                  | Cesto in filo, fodera cotone                            | 358               |
| Apparecchio cottura sottovuoto | 513                   | Caffettiera pressa filtro        | 354              | Cesto pane  | 358, 414-420, 467 |
| Apribottiglie                  | 86, 90                | Campanella reception             | 372              | Cesto pane carta kraft                                  | 357               |
| Apriscatole                    | 86, 90-91, 124        | Candelabro                       | 370              | Cesto pane cotone                                       | 420, 358-359      |
| Apriscatole da banco           | 126                   | Candele led                      | 371, 411         | Cesto per riso dolce                                    | 264               |
| Apriscatole elettrico          | 520                   | Candeliere                       | 369-370          | Cesto uova  | 420               |
| Apriuova                       | 116                   | Cannello                         | 197              | Chitarra  | 113, 199          |
| Arricciaburro                  | 87, 92                | Cannoli                          | 191              | Ciotola doppia parete                                   | 434-435           |
| Aspirapolvere meccanico        | 482                   | Cannucce                         | 307-308          | Ciotola refrigerata                                     | 425               |
| Asta appendi mestoli           | 100                   | Cappello Chef                    | 169              | Ciotola tortillas                                       | 47                |
| Asta porta scontrini           | 103-104               | Caraffa                          | 316, 354-355     | Ciotola, legno  | 337-338           |
| Aste delimita corsie           | 496                   | Caraffa cereali                  | 430              | Ciotola, MF257-258, 350-351, 394-396, 399-402, 424, 426 | 424               |
| <b>B</b>                       |                       | Caraffa graduata                 | 105              | Ciotolina   | 296-298           |
| Bacchette cinesi               | 262, 269              | Caraffa sake                     | 261              | Ciotolina degustazione                                  | 260-261, 341-342  |
| Bacchette giapponesi           | 262                   | Caraffa termica                  | 354, 432         | Ciotolina gourmet                                       | 296               |
| Bacinella carré                | 195                   | Caramellizzatore                 | 196, 518         | Clip chiudi sacco                                       | 112, 192          |
| Bacinella conica               | 108                   | Carapina                         | 291              | Clip porta targhetta                                    | 420               |
| Bacinella gelato               | 291                   | Carrelli room-service            | 455-458          | Clip reggibicchiere                                     | 330               |
| Bacinella planetaria           | 110                   | Carrelli sala                    | 450-458          | Clips per coperchi                                      | 71                |
| Bacinella semisferica          | 108, 110              | Carrello convertibile            | 478              | Cloche  | 288-289, 362      |
| Bagnomaria                     | 26, 31, 38            | Carrello di servizio             | 476-477          | Cocotte per molluschi                                   | 365               |
| Bar, articoli                  | 302-331               | Carrello ghiaccio                | 472              | Colafritto  | 25, 100           |
| Barattoli degustazione         | 333                   | Carrello lavapavimenti           | 484-485          | Colapasta   | 108-109           |
| Barbecue da tavola             | 46, 364               | Carrello per ctn isoterma        | 470              | Colapasta a spicchi                                     | 26                |
| Barca sushi/sashimi            | 260                   | Carrello per derrate             | 466              | Colapasta conico  | 108               |
| Barra porta coltelli magnetica | 160                   | Carrello porta biancheria        | 481-482          | Colatutto gigante                                       | 111               |
| Barriera autoportante          | 493                   | Carrello porta cassette          | 478              | Colino  | 82, 89, 111-112   |
| Barriera protettiva            | 492-494               | Carrello porta cestelli          | 462              | Colino cocktail   | 310               |
| Base per ganache & telai       | 199                   | Carrello porta piatti            | 463, 473         | Colino conico   | 82, 89            |
| Bastardella semisferica        | 38                    | Carrello porta sacco             | 486              | Colino Julep  | 310               |
| Batticarne                     | 162                   | Carrello porta teglie            | 476-477          | Collare salvagoccia                                     | 369               |
|                                |                       | Carrello Quick Cart              | 480              | Colonna luminosa  | 407               |
|                                |                       | Carrello rifornimento frigobar   | 477              | Colonna portasecchiello                                 | 367               |
|                                |                       |                                  |                  | Coltelleria forgiata                                    | 137-139           |

|                                |                   |                              |                                  |                       |                                |                       |                    |
|--------------------------------|-------------------|------------------------------|----------------------------------|-----------------------|--------------------------------|-----------------------|--------------------|
| Coltelleria stampata           | 140-153           | Coppino salsa                | 391                              | <b>E</b>              | Elenco prodotti Gluten Free    | 521-525               |                    |
| Coltelli Giapponesi            | 156-157           | Coprimanico silicone         | 33, 44                           |                       | Erogatore automatico           | 488                   |                    |
| Coltello agrumi                | 87                | Copripiatto                  | 104                              |                       | Espositore buffet              | 427-429               |                    |
| Coltello apriostriche/cozze    | 84, 90            | Copriscarpe                  | 169, 490                         |                       | Espositore cereali             | 430                   |                    |
| Coltello arrosto               | 391               | Cordone                      | 496                              |                       | Espositore marmellate          | 430                   |                    |
| Coltello castagne              | 84                | Cornetti                     | 191                              |                       | Espositore mini cornetti       | 299                   |                    |
| Coltello decoratore            | 88, 92            | Cornetto cinese              | 111                              |                       | Espositore per vetrina gelato  | 298-299               |                    |
| Coltello farinata              | 96                | Couscoussiera                | 28                               |                       | Espositore porta frutta        | 427                   |                    |
| Coltello formaggio             | 84, 85, 89        | Crème caramel                | 209                              |                       | Espositore sacchetti/bocchette | 193                   |                    |
| Coltello ghiaccio              | 121               | Crepiera                     | 500-501                          |                       | Etichette dissolvibili         | 133-134               |                    |
| Coltello grana                 | 85                | Cucchiari decoratori         | 106, 181                         |                       | <b>F</b>                       | Falcetta macellaio    | 150-151            |
| Coltello marzapane             | 181               | Cucchiaini monouso           | 331                              |                       |                                | Falcetta prezzemolo   | 84                 |
| Coltello panettone             | 390               | Cucchiaino sale              | 391                              |                       |                                | Falso fondo forato    | 60, 62, 64, 66, 69 |
| Coltello pizza                 | 84                | Cucchiaio a servire          | 390-391                          |                       |                                | Fascia microforata    | 209                |
| Coltello pizzaiolo             | 274               | Cucchiaio assenzio           | 310                              |                       |                                | Fasciatoio            | 480                |
| Coltello pompelmo              | 87, 91            | Cucchiaio bibita             | 310, 392                         |                       |                                | Ferma prosciutto      | 163-164            |
| Coltello torta                 | 85, 96            | Cucchiaio brodo              | 260                              |                       |                                | Fermatovaglia         | 362                |
| Coltello verdure               | 84, 89            | Cucchiaio cinese             | 261                              |                       |                                | Finger-food           | 343-344            |
| Combi mixer/frusta             | 506               | Cucchiaio cocktail           | 92                               |                       |                                | Flacone dosatore      | 106                |
| Combinato cutter/tagliaverdure | 507-508           | Cucchiaio finger-food        | 397                              |                       |                                | Flacone nebulizzatore | 203                |
| Compressore x penna aerografa  | 196, 517          | Cucchiaio ghiaccio           | 318, 392                         |                       |                                | Flacone per bagne     | 203                |
| Cono boston                    | 313               | Cucchiaio insalata           | 93                               |                       |                                | Flair bottle          | 320                |
| Contenitore cilindrico         | 26                | Cucchiaio magico             | 310                              |                       |                                | Fonduta bourguignonne | 38, 363            |
| Contenitore con coperchio      | 286, 294          | Cucchiaio miscelatore        | 309                              | Fonduta formaggio     |                                | 363                   |                    |
| Contenitore isoteramico        | 276               | Cucchiaio monoporzione       | 392                              | Fontana cioccolato    |                                | 407, 515              |                    |
| Contenitore per alimenti       | 465-466           | Cucchiaio parmigiano         | 391                              | Fontana cocktails     |                                | 407                   |                    |
| Contenitore per cannucce       | 294               | Cucchiaio riso               | 93-94, 263, 391                  | Forbice antipasti     |                                | 389                   |                    |
| Contenitore per cialde         | 294               | Cucchiaio salsa              | 392                              | Forbice dolci         |                                | 389                   |                    |
| Contenitore per impasti        | 279               | Cucchiaio silicone           | 94                               | Forbice erbe          |                                | 117                   |                    |
| Contenitore per palette        | 294               | Cucchiaio spaghetti          | 100                              | Forbice pizza         |                                | 274                   |                    |
| Contenitore per riso dolce     | 264               | Cucchiaione                  | 79-81, 100-101                   | Forbice polpette      |                                | 81                    |                    |
| Contenitore per uova           | 116               | Cucchiaione forato           | 80, 93-94, 100                   | Forbice quenelle      |                                | 81                    |                    |
| Contenitore rifiuti            | 485               | Cucchiaione forato unipezzo  | 98                               | Forbice sigari        |                                | 373                   |                    |
| Contenitore riserva            | 323               | Cucchiaione forato unipezzo  | 98                               | Forbice torta         | 389                            |                       |                    |
| Contenitore salvaspazio        | 467               | Cucchiaione obliquo unipezzo | 98                               | Forbice tutto servire | 389                            |                       |                    |
| Contenitore universale         | 288, 293          | Cucchiaione salse            | 100                              | Forbice uva           | 389                            |                       |                    |
| Contenitore versatore          | 322-323           | Cucchiaione unipezzo         | 98-99                            | Forbice verdure       | 389                            |                       |                    |
| Contenitore x trasp stoviglie  | 464               | Cucina etnica, articoli      | 256-269                          | Forbici cucina        | 154-155                        |                       |                    |
| Contenitori isotermitici       | 469-470, 472      | Cuffia, TNT                  | 169, 490                         | Forbici cucina cinesi | 268                            |                       |                    |
| Contenitori sovrapponibili     | 467-468           | Cuoci riso a vapore          | 511                              | Forchetta a servire   | 390                            |                       |                    |
| Coperchio bacinella gelato     | 291               | Cuocivapore                  | 264, 267                         | Forchetta insalata    | 92                             |                       |                    |
| Coperchio cesto pane           | 418               | Cutter da tavolo             | 503, 508                         | Forchetta lumache     | 392                            |                       |                    |
| Coperchio ciotole              | 424, 426          | <b>D</b>                     | Densimetro x salamoia/sale       | 132                   | Forchetta monoporzione         | 392                   |                    |
| Coperchio ermetico x ciotole   | 424               |                              | Detergente igienizzante          | 484                   | Forchette fonduta              | 364                   |                    |
| Coperchio roll-top             | 288, 418, 421-423 |                              | Disidratatore                    | 503                   | Forchettina 3 punte            | 91                    |                    |
| Copertura igienica             | 414-415           |                              | Dispenser cuffie                 | 491                   | Forchettina ostriche           | 392                   |                    |
| Copertura protettiva           | 463               |                              | Dispenser gel a pedale           | 490                   | Forchettine aragosta           | 366                   |                    |
| Copertura termica              | 473               |                              | Dispenser guanti                 | 490-491               | Forchettine lumache            | 366                   |                    |
| Coperture monouso x carrelli   | 475               |                              | Dispenser kit visitatore         | 491                   | Forchettine monouso            | 331                   |                    |
| Coppa ananas                   | 303               |                              | Dispenser mascherine             | 491                   | Forchettine pralineria         | 181                   |                    |
| Coppa burro                    | 356               |                              | Display per buffet               | 405-406               | Forchettone                    | 93-94, 100, 153, 391  |                    |
| Coppa caviale                  | 366               |                              | Distributore bevande isoteramico | 472                   | Forchettone spaghetti          | 391                   |                    |
| Coppa champagne                | 303               |                              | Distributore cereali             | 430-431               | Forchettone unipezzo           | 98-99                 |                    |
| Coppa crème brûlée             | 50                |                              | Distributore latte               | 431-432               | Formaggiaria                   | 361                   |                    |
| Coppa gelato                   | 295               |                              | Distributore panini              | 415                   | Forno microonde                | 512                   |                    |
| Coppa margarita                | 303               |                              | Distributore panini              | 415                   | Forno multifunzione            | 501                   |                    |
| Coppa martini                  | 303               |                              | Distributore succhi              | 431-432               | Friggitrice                    | 501-502               |                    |
| Coppa mint julep               | 305               |                              | Distributore termico             | 432                   | Frullatore                     | 510-511               |                    |
| Coppa punch                    | 408               |                              | Dosa caffè                       | 91                    | Frullino                       | 510-511               |                    |
| Coppa riso                     | 257, 259          |                              | Dosa creme                       | 195                   | Frusta                         | 100, 103, 82, 88, 94  |                    |
| Coppa soufflé                  | 47                |                              | Dosatore                         | 105-106               |                                |                       |                    |
| Coppa spumante                 | 314               |                              | Dosatore miele/cremiera          | 285                   |                                |                       |                    |
| Coppa zucca                    | 303               |                              | Dosatrice per creme              | 195                   |                                |                       |                    |
| Coppetta                       | 296-298           |                              |                                  |                       |                                |                       |                    |
| Coppetta sake                  | 261               |                              |                                  |                       |                                |                       |                    |



**G**

Ganci macellaio 161  
 Gancio appendi borsa 367  
 Gastronorm acciaio inox 52-60  
 Gastronorm alluminio 59  
 Gastronorm antiaderenti 55  
 Gastronorm melamina 72-73  
 Gastronorm policarbonato 61-62  
 Gastronorm polipropilene 65-71  
 Gastronorm porcellana 74-77  
 Gastronorm smaltate 60  
 Gastronorm Tritan 63-64  
 Gel combustibile 449  
 Gel igienizzante 489  
 Gelateria, articoli 290-301  
 Girello 193  
 Glacette termica 367-368  
 Grattugia 90, 122-123  
 Grattugia 4 tagli 123  
 Grattugia automatica 118  
 Grattugia formaggio 86, 118  
 Grattugia noce moscata 123  
 Grattugia spatzie 123  
 Grattugia wasabi 268  
 Grembiule barman 325  
 Grembiule cotta di maglia 167  
 Grembiule LDPE 169, 489  
 Griglia di colaggio 194  
 Griglia di raffreddamento 194  
 Griglia Dim Sum 265  
 Griglia in filo 60  
 Griglia kebab/gyros 500  
 Griglia per cottura a vapore 265  
 Griglia per tempura 265  
 Griglia smaltata 60  
 Griglie pasticceria, inox 218  
 Griglie pasticceria, plastica 218-219  
 Grill a contatto 499  
 Guaina silicone, ISI 301  
 Guanti da forno 167-168  
 Guanti in lattice 168  
 Guanti monouso 489  
 Guanti scrub 168  
 Guanto anti taglio 168  
 Guanto in cotta di maglia 167

**I**

Imbuto 104-105  
 Imbuto colatore 195  
 Imbuto, ISI 301  
 Impastatrice planetaria 512  
 Iniettori/siringhe, ISI 301  
 Insacatrice 164  
 Insalatiera 357, 398  
 Inserti scaldavivande 447-448  
 Intaglia verdure 119

**JK**

Japanese jigger 311  
 Kit infusione rapida, ISI 301  
 Kit visitatore, TNT 169, 490

**L**

Laccetti da cucina 113  
 Lame panettiere 255  
 Lampada infrarossi 505  
 Lampada zucchero 196, 516  
 Lanterne 410  
 Lattiera cappuccino 286  
 Lattiera con coperchio 286  
 Legatovagliolo 362  
 Levacapsule 330  
 Levatorsoli 88, 91  
 Lira per formaggi 118  
 Lira per pan di Spagna 198

**M**

Macchina per cialde 504-505  
 Macchina per gelato 503  
 Macchina per raclette 363, 516  
 Macina erbe/peperoncino 384-385  
 Macina noce moscata 385-386  
 Macina pepe/sale 377-387  
 Macina per sale umido 383-384  
 Macina semi lino/sesamo 386  
 Macina/spargi cannella 386  
 Macinaerbe 124  
 Mandolino 119  
 Manico mop 483  
 Manico telescopico 483  
 Mannaietta formaggio 85, 89  
 Mantecatore burro 122  
 Marcatore pane Kaiser 255  
 Mascherine cacao 284  
 Mascherine monouso 489  
 Mestolino salsa 92  
 Mestolo 80-81, 92, 94, 100, 269, 391  
 Mestolo c/becco 99  
 Mestolo c/becco, unipezzo 98  
 Mestolo forato 81  
 Mestolo forato manico tubo 98  
 Mestolo forato unipezzo 98  
 Mestolo manico tubo 98  
 Mestolo pizza, fondo piatto 81, 279  
 Mestolo unipezzo 98-99  
 Mezzaluna 152-153  
 Miscelatori cocktail 308-309  
 Misurini 105  
 Misurino cocktail 311  
 Mixer 506-507  
 Molla asparagi 390  
 Molla frutta 389  
 Molla ghiaccio 320, 390  
 Molla insalata 80  
 Molla lumache 390  
 Molla pane 80, 390  
 Molla pasticceria 80  
 Molla spaghetti 80, 389  
 Molla toast 389  
 Molla tutto servire 389  
 Molla universale 389  
 Molla zucchero 390  
 Mop cotone 483-484  
 Mop microfibra 482  
 Mortaio c/pestello 268

Multi-distributore 428-429

**NO**

Nastro adesivo x sottovuoto 131  
 Nastro PVC 206  
 Nebulizzatore olio/acetato 360  
 Noccioli ceramica 205  
 Oliera 268, 271  
 Omogeneizzatore 508  
 Orologio da parete 134

**P**

Padella antiaderente 12, 22, 29, 30, 40, 266  
 Padella balti/karahi 266  
 Padella ferro 33, 265, -267  
 Padella giapponese 266  
 Padella Tamagoyaki 266  
 Padella Tawa 267  
 Padella Toban 266  
 Pala a ridurre 99  
 Pala manicata 274  
 Pala pasticcio 93, 96  
 Pala per patate fritte 101  
 Pala pizza 271-273  
 Pala torta 93, 193, 390  
 Paletta 269  
 Paletta angolare 79, 96  
 Paletta cenere 272  
 Paletta dolci 96  
 Paletta forata 81, 93-95, 100  
 Paletta forata unipezzo 99  
 Paletta fritti 80  
 Paletta liscia unipezzo 99  
 Paletta manico lungo 483  
 Paletta pesce unipezzo, forata 99  
 Paletta silicone 94  
 Pallet 487  
 Panni microfibra 484  
 Panno passabrodo 112  
 Passapomodoro 124  
 Passathé 356  
 Passaverdura 111, 125  
 Passaverdura elettrico 124, 520  
 Passaverdura su supporto 124  
 Pasticceria, articoli 170-255  
 Pattumiera a pedale 485-487  
 Pedana 487  
 Pela arance 115  
 Pela mele 115  
 Pela verdure su supporto 114  
 Pela/svuota ananas 114  
 Pela/taglia avocado 117  
 Pelapatate 87, 91, 117  
 Pelapomodori 87  
 Pelarance 87, 91  
 Pelasparagi 87  
 Pelatrice elettrica 115, 503  
 Pelaverdure 117  
 Penna aerografa 196  
 Penna gesso liquido 292, 420  
 Pennarelli 71  
 Pennello 85, 90, 202  
 Pennello per wok 269  
 Pentola cinese 267

|                               |               |                                |                  |                            |                        |
|-------------------------------|---------------|--------------------------------|------------------|----------------------------|------------------------|
| Pentola per riso dolce        | 264           | Porta piatti                   | 463              | Runner                     | 347                    |
| Pentolame 3-Ply               | 21-23, 434    | Porta rotolo                   | 104, 475         | <b>S</b>                   |                        |
| Pentolame acciaio inox        | ott-20        | Porta snack                    | 332-333          | Sacchetto per decorare     | 191-192                |
| Pentolame alluminio           | 27-31, 39     | Porta tovaglioli               | 293              | Sacco vinile               | 481                    |
| Pentolame ghisa smaltata      | 41-48         | Portacandela                   | 370-371          | Salamandra                 | 500                    |
| Pentolame rame                | 34-38         | Portaciotole                   | 424-426          | Salinometro/termometro     | 133                    |
| Percolatore per caffè         | 445, 514      | Portacombustibile              | 448              | Salsiera                   | 260, 356-357           |
| Pesa sciropo/densimetro       | 132, 198      | Portacondimenti                | 324, 362         | Samovar                    | 444-445, 514-515       |
| Pesciera                      | 25, 31, 38    | Portagiornale                  | 372              | Saponetta togli odori      | 92                     |
| Pestaghiaccio                 | 318           | Portagrissini                  | 361              | Sbuccia melone             | 87                     |
| Petite marmite                | 440           | Portaposate                    | 361-362, 424     | Sbucciato a Y              | 87, 91                 |
| Pettine Charlotte             | 217           | Portarifiuti da tavola         | 365              | Sbucciato lama mobile      | 91                     |
| Pettini decoratori            | 203           | Portasigaro con piattino       | 373              | Scalda wüstel              | 500                    |
| Peugeot                       | 374-387       | Portaspago                     | 163              | Scaldacaffè                | 443                    |
| Piano caldo                   | 505           | Portataglieri                  | 167              | Scaldacognac               | 369                    |
| Piastra induzione             | 438, 514      | Portatoast                     | 356              | Scaldapiatti               | 502                    |
| Piastrer elettriche           | 449           | Portatovaglioli                | 287              | Scaldavivande              | 436-443                |
| Piattino degustazione         | 341-342       | Portauovo                      | 356              | Scaletta pieghevole        | 487                    |
| Piattino fingerfood           | 395           | Porzionatore                   | 87, 91, 267, 292 | Scalpellino ghiaccio       | 121                    |
| Piattino fondo                | 260, 351      | Porzionatore riso              | 112              | Scatola bento              | 259                    |
| Piattino piano                | 260, 366      | Posacenero                     | 372              | Scatola portabustine thè   | 286                    |
| Piatto                        | 258, 398, 401 | Posacenero a colonna           | 488              | Scavazucchine              | 86, 91                 |
| Piatto con campana            | 349           | Posate caviale                 | 366              | Scavino                    | 86, 91                 |
| Piatto frittura ghisa         | 267           | Pressa bottiglie/lattine       | 125              | Schiaccianoci              | 365                    |
| Piatto frutti di mare         | 366-367, 407  | Pressa hamburger               | 164              | Schiacciapate              | 117                    |
| Piatto lumache                | 366           | Pressapotate                   | 89-90            | Schiuma detergente         | 488                    |
| Piatto pizza c/tagliere legno | 275           | Pressapolipo                   | 113              | Schiumarola                | 80-81, 93-94, 100, 269 |
| Piatto servire sushi          | 259           | Presse canard                  | 113              | Schiumarola a filo         | 101                    |
| Piatto torta                  | 288-289       | Provetta alimentare            | 198              | Schiumarola a rete         | 100                    |
| Pietra per affilare           | 153           | Pulizia & sicurezza, articoli  | 479-496          | Schiumarola fritto         | 269                    |
| Pinza affettati               | 162           | Pungisalame                    | 160              | Schiumarola unipezzo       | 99-100                 |
| Pinza aragosta                | 365           | Puntale c/moschettone          | 496              | Schiumarola Wonton         | 268                    |
| Pinza bar                     | 309           | <b>QR</b>                      |                  | Sciabola per Sommelier     | 369                    |
| Pinza champagne               | 369           | Quadri per ganache             | 199              | Scolapiatti a muro         | 463                    |
| Pinza cucina                  | 102-103       | Raccoglibriciole               | 363              | Scopa                      | 483                    |
| Pinza grill                   | 102           | Raschia/tagliapasta            | 278-279          | Scopa + alza immondizia    | 482                    |
| Pinza per anatra              | 268           | Raschiotti                     | 202-203          | Scopa a forbice            | 482                    |
| Pinza per mop                 | 483           | Raschiotti decorativi          | 292              | Scopa spingiacqua          | 483                    |
| Pinza servire                 | 80, 102-103   | Raschietto ceppa               | 167              | Scovolini per cannuce      | 307                    |
| Pinza teglie                  | 274           | Rastelliera teglie pizza       | 280              | Secchio ghiaccio           | 320, 472               |
| Pinza togli lische            | 102           | Rastrelliera                   | 103, 326         | Secchio graduato           | 109, 485               |
| Pirofila ovale                | 397           | Rastrelliera porta bicchieri   | 326              | Secchio portabottiglie     | 408                    |
| Pistola elettrica             | 196, 517      | Rastrelliera retine pizza      | 280              | Secchio vino               | 367                    |
| Pizza, articoli               | 270-282       | Rastrello                      | 272              | Sega per ossa              | 163                    |
| Pizzi sottotorta              | 193           | Rechaud                        | 364-365          | Seggiolone                 | 480                    |
| Placca biscotti               | 219           | Recipiente multiuso            | 463              | Segnagusto                 | 293                    |
| Plancia                       | 348-349, 400  | Reggi caramellometro           | 198              | Segnalatore telescopico    | 484                    |
| Plancia a servire             | 335-337       | Retina pizza                   | 280              | Segnaporzioni              | 201                    |
| Pompa sottovuoto per vino     | 330           | Ricambi                        | 525-533          | Senapiera                  | 356                    |
| Pompetta per sugo             | 102           | Ricariche sifone panna, ISI    | 301              | Separatore GN              | 60                     |
| Pompetta terminale in rame    | 197           | Ricariche sifone panna, Kayser | 300              | Separauova                 | 92                     |
| Ponte sushi/sashimi           | 259           | Ricariche sifone soda, ISI     | 318              | Servispaghetti             | 93-94                  |
| Porta Brezel                  | 414           | Riga                           | 198              | Servitartufi               | 359                    |
| Porta bustine zucchero        | 286           | Rigalimoni                     | 88, 92           | Servizio caffè             | 287, 338               |
| Porta cannuce                 | 286           | Riscalda sake                  | 261              | Servizio oliera            | 360-361                |
| Porta coltelli                | 160           | Rompighiaccio                  | 318              | Sessola                    | 107                    |
| Porta coni                    | 294-295       | Rotella taglia pasta           | 84, 88, 200      | Sessola ghiaccio           | 318                    |
| Porta coni da banco           | 293           | Rotella taglia pizza           | 84, 88, 274      | Set aperitivo/degustazione | 333-334                |
| Porta coppette                | 340           | Rotolo portacoltelli           | 159              | Set cottura riso dolce     | 264                    |
| Porta cucchiaini              | 286           | Rullo                          | 201              | Setaccio                   | 107, 203               |
| Porta menù                    | 371           | Rullo bucasfoglia              | 200              | Sgocciolatore              | 237                    |
| Porta oggetti bar             | 320           | Rullo losanghe                 | 200              | Shaker                     | 311                    |
| Porta olio/acetato            | 361           | Rullo tagliapasta              | 200, 202         | Sifone nitro, ISI          | 284                    |
| Porta pale                    | 273           |                                |                  |                            |                        |
| Porta palette/coppette        | 294           |                                |                  |                            |                        |

|                               |                        |                                  |         |                                |                   |
|-------------------------------|------------------------|----------------------------------|---------|--------------------------------|-------------------|
| Sifone panna, ISI             | 300                    | Stiletto aragosta                | 365     | Targhetta tavola               | 371               |
| Sifone panna, Kayser          | 300                    | Stiletto thailandese             | 121     | Tastevin                       | 369               |
| Sifone soda, ISI              | 317                    | Stoccaggio & trasporto, articoli | 459-478 | Tavola, articoli               | 345-387           |
| Sifone termico, ISI           | 300                    | Stoneware                        | 40      | Tavolino con box termico       | 474               |
| Siringa per marinata          | 102                    | Stuoietta sushi                  | 263     | Tavolino room service          | 457-458           |
| Siringa per pasticceria       | 192                    | Stuzzicadenti                    | 331     | Tazza Cola                     | 305               |
| Sistema di pulizia, kit Pulse | 482                    | Supporto bacchette cinesi        | 262     | Tazza julep                    | 306               |
| Sottopentola                  | 44, 365                | Supporto bottiglie a parete      | 326     | Tazza moscow mule              | 303-305           |
| Soufflè                       | 50                     | Supporto bottiglie rotante       | 326     | Tazza soba choko               | 259               |
| Spade                         | 161                    | Supporto buffet                  | 394     | Tea light led                  | 371               |
| Spalmaburro                   | 85, 90                 | Supporto chafing dish            | 447     | Tegame rettangolare            | 25, 30-31, 38, 44 |
| Spargicacao                   | 285                    | Supporto girevole                | 349     | Tegamino uova                  | 50                |
| Spargiformaggio               | 361                    | Supporto in filo                 | 419-420 | Teglia forata, alluminio       | 194, 282          |
| Spargisale/pepe               | 360-361                | Supporto mobile                  | 466     | Teglia forata, antiaderente    | 280, 282          |
| Spargizucchero                | 203, 285               | Supporto murale pellicola        | 104     | Teglia forata, siliconata      | 195               |
| Spatola                       | 79-81, 90, 93, 96, 101 | Supporto murale per gel          | 490     | Teglia monoporzioni            | 220               |
| Spatola gelato                | 291                    | Supporto numero tavola           | 371     | Teglia pizza, antiaderente     | 280               |
| Spatola hamburger             | 96                     | Supporto per abbattitore         | 298     | Teglia pizza, ferro blu        | 280-281           |
| Spatola pasticcio e pizza     | 96                     | Supporto per cottura a vapore    | 265     | Teglia, all siliconato         | 205               |
| Spatola per biscuit           | 198                    | Supporto per temaki              | 260     | Teglia, all siliconato, forato | 205               |
| Spatola per stemperare        | 79                     | Supporto piatto frutti mare      | 366     | Teglia, alluminio              | 194, 280-282      |
| Spatola resina                | 103                    | Supporto porta vasetti           | 353     | Teglia, alluminio              | 194, 282          |
| Spatole crêpes                | 101                    | Supporto secchio da tavola       | 367     | Teglia, antiaderente           | 195, 282          |
| Spatolina burro               | 391                    | Supporto targhetta               | 371     | Teglia, siliconata             | 195               |
| Spazzola forno pizza          | 272-273                | Svuota ananas                    | 86, 115 | Telai torte                    | 207-209           |
| Spazzola grill                | 103                    | Svuota carciofi                  | 116     | Telaio pieghevole              | 480               |
| Spazzola pane                 | 255                    |                                  |         | Telaio regolabile              | 207               |
| Spazzola per ceppa            | 165                    | <b>T</b>                         |         | Temperatrice                   | 197, 299-300, 517 |
| Spazzola per griglia          | 273                    | Tabella x aste separa corsie     | 495     | Temperino verdure              | 85                |
| Spazzola per wok              | 269                    | Taglia ananas                    | 115     | Termoigrometro                 | 132               |
| Spazzole lavabicchieri        | 326                    | Taglia capsula                   | 329     | Termometri                     | 127-133, 285      |
| Specchio buffet               | 409-410                | Taglia cavolini di Bruxelles     | 116     | Termometro IR frontale         | 489               |
| Spelucchino                   | 89                     | Taglia croissants                | 201     | Termometro zucchero            | 197               |
| Spiedini                      | 161, 262, 330          | Taglia cubi                      | 114     | Termoregolatore                | 449               |
| Spiedini cocktail             | 331                    | Taglia funghi                    | 117     | Testate pela verdure           | 114               |
| Spillone portascontrini       | 103                    | Taglia pane                      | 415     | Tester oli di frittura         | 133               |
| Spremiaglio                   | 90, 118                | Taglia patate                    | 117     | Tiki mug in ceramica           | 307               |
| Spremiagrumi elettrico        | 509-511                | Taglia ricci di mare             | 365     | Tiki mug teschio in vetro      | 306               |
| Spremiagrumi manuale          | 317                    | Taglia tortillas                 | 118     | Timer                          | 132               |
| Spremilimone                  | 317                    | Taglia uova                      | 115-116 | Tortiere, alluminio            | 210               |
| Squamapesce                   | 84-85, 89, 269         | Tagliapasta con espulsore        | 180-181 | Tortiere, antiaderenti         | 212-217           |
| Stampi mini push up pops      | 299                    | Tagliapasta estensibile          | 200     | Tostapane                      | 498               |
| Stampi natalizi               | 231                    | Tagliapasta, inox                | 171-179 | Tovaglietta                    | 347               |
| Stampi pasquali               | 231                    | Tagliapasta, PA+                 | 180     | Trancia spicchi                | 114-115           |
| Stampi, silicone              | 232-253                | Tagliasigari da tavola           | 373     | Trincipollo                    | 154               |
| Stampo Bordelais              | 38                     | Tagliatartufi                    | 359     | Tritacarne                     | 518               |
| Stampo burro                  | 122                    | Tagliaverdura turn'up            | 119     | Tritaghiaccio                  | 318               |
| Stampo cioccolato magnetico   | 228                    | Tagliaverdure                    | 88, 114 | Tritaghiaccio automatico       | 510-511           |
| Stampo cioccolato, PC         | 222-229                | Tagliaverdure elettrico          | 507     | Tronchetto tagliapizza         | 274               |
| Stampo cioccolato, silicone   | 221                    | Tagliaverdure ghirlanda          | 115     |                                |                   |
| Stampo decora crostate        | 201                    | Tagliaverdure spiralizzatore     | 120-121 | <b>UV</b>                      |                   |
| Stampo gelato                 | 298-299                | Tagliere a servire               | 400     | Utensili da cucina             | 78-136            |
| Stampo ghiaccio               | 318-319                | Tagliere con vasca               | 165-167 | Utensili decoro                | 121               |
| Stampo mooncake               | 263                    | Tagliere pane                    | 414     | Utensili marzapane             | 181               |
| Stampo nigiri/maki            | 263                    | Tagliere servizio, legno         | 337-340 | Valigia barman                 | 325               |
| Stampo pane                   | 254                    | Tagliere sup porcellanata        | 339     | Valigia cuoco                  | 158               |
| Stampo panzerotti             | 124                    | Tagliere sushi                   | 259     | Vaporiera                      | 512               |
| Stampo per tronco             | 217                    | Tampone finto legno              | 217     | Vasca di drenaggio             | 466               |
| Stampo uovo                   | 230                    | Tappetino bar                    | 324     | Vasca riso hangiri             | 264               |
| Stand per vassoio             | 411                    | Tappeto silicone                 | 204     | Vasetti con coperchio          | 352-353           |
| Stand porta gel/guanti        | 490                    | Tappeto sottobicchieri           | 324     | Vaso conserva tartufo          | 359               |
| Stazione igiene mani          | 488                    | Tappo spumante                   | 328     | Vaso fiori                     | 369               |
| Stencils                      | 221                    | Tappo versatore dosatore         | 327-328 | Vaso porta sacchetto           | 193               |
| Stendipasta                   | 198                    | Tappo vino                       | 328     | Vaso soia                      | 261               |
| Sterilizzatore                | 160, 520               |                                  |         |                                |                   |

|                         |   |
|-------------------------|---|
| Vassoio bento           | 259                                     |
| Vassoio con coperchio   | 299                                     |
| Vassoio con gambe       | 455                                     |
| Vassoio conto           | 287                                     |
| Vassoio espositore      | 163, 204                                |
| Vassoio Euronorm        | 475                                     |
| Vassoio fast food       | 474                                     |
| Vassoio Gastronorm      | 475                                     |
| Vassoio Gourmet         | 296                                     |
| Vassoio macelleria      | 163                                     |
| Vassoio portatovagliolo | 259                                     |
| Vassoio rettangolare    | 163                                     |
| Vassoio reversibile     | 259                                     |
| Vassoio room service    | 455                                     |
| Vassoio sushi           | 396                                     |
| Vassoio zarusoba        | 259                                     |
| Vassoio, inox           | 411-412                                 |
| Vassoio, MF             | 257-258, 350-351, 395-396, 399, 402-404 |
| Versatore vino          | 369                                     |
| Versavino               | 369                                     |
| Vetrina                 | 421-422                                 |
| Vetrina antipasti       | 503                                     |
| Vetrina brioches        | 287                                     |
| Vetrina refrigerata     | 423                                     |
| Vetrina riscaldata      | 502                                     |
| Vetrina sigari          | 373                                     |
| Visiera facciale        | 489                                     |

## WZ

|                         |                     |
|-------------------------|---------------------|
| Wok                     | 22, 33, 43, 264-265 |
| Zuppiera                | 445-446, 516        |
| Zuppiera testa di leone | 357                 |

**NUMERICAL INDEX**

INDICE NUMERICO

NUMERISCH INDEX

INDEX NUMERIQUE

INDICE NUMERICO

| Cod.     | pag. | Cod.     | pag. | Cod.     | pag. | Cod.     | pag. | Cod.     | pag. | Cod.     | pag. | Cod.     | pag. |
|----------|------|----------|------|----------|------|----------|------|----------|------|----------|------|----------|------|
| 11001-16 | 15   | 11009-45 | 15   | 11101-50 | 11   | 11112-24 | 12   | 11161-50 | 12   | 11716-36 | 33   | 11742-60 | 281  |
| 11001-18 | 15   | 11009-50 | 15   | 11102-28 | 11   | 11113-18 | 12   | 11161-60 | 12   | 11716-40 | 33   | 11744-20 | 280  |
| 11001-20 | 15   | 11009-60 | 15   | 11102-32 | 11   | 11113-20 | 12   | 11617-20 | 29   | 11716-45 | 33   | 11744-24 | 280  |
| 11001-22 | 15   | 11010-16 | 15   | 11102-36 | 11   | 11113-24 | 12   | 11617-24 | 29   | 11717-34 | 33   | 11744-28 | 280  |
| 11001-24 | 15   | 11010-18 | 15   | 11102-40 | 11   | 11113-26 | 12   | 11617-28 | 29   | 11717-37 | 33   | 11744-32 | 280  |
| 11001-28 | 15   | 11010-20 | 15   | 11102-45 | 11   | 11114-20 | 12   | 11617-32 | 29   | 11717-42 | 33   | 11750-11 | 60   |
| 11001-32 | 15   | 11010-24 | 15   | 11102-50 | 11   | 11114-24 | 12   | 11701-02 | 271  | 11717-47 | 33   | 11760-11 | 60   |
| 11001-36 | 15   | 11011-16 | 16   | 11102-99 | 525  | 11114-28 | 12   | 11701-06 | 271  | 11718-20 | 33   | 11910-12 | 26   |
| 11001-40 | 15   | 11011-18 | 16   | 11105-16 | 11   | 11114-32 | 12   | 11701-10 | 271  | 11718-22 | 33   | 11910-14 | 26   |
| 11001-45 | 15   | 11011-20 | 16   | 11105-20 | 11   | 11114-36 | 12   | 11701-13 | 271  | 11718-24 | 33   | 11910-16 | 26   |
| 11001-50 | 15   | 11011-24 | 16   | 11105-24 | 11   | 11114-40 | 12   | 11701-16 | 271  | 11721-28 | 33   | 11910-18 | 26   |
| 11001-60 | 15   | 11012-16 | 15   | 11105-28 | 11   | 11114-45 | 12   | 11702-02 | 271  | 11739-20 | 280  | 11910-20 | 26   |
| 11006-12 | 16   | 11012-18 | 15   | 11105-32 | 11   | 11115-20 | 12   | 11702-06 | 271  | 11739F20 | 521  | 11911-12 | 26   |
| 11006-14 | 16   | 11012-20 | 15   | 11105-36 | 11   | 11115-24 | 12   | 11702-10 | 271  | 11739-24 | 280  | 11911-14 | 26   |
| 11006-16 | 16   | 11012-24 | 15   | 11105-40 | 11   | 11115-28 | 12   | 11702-16 | 271  | 11739F24 | 521  | 11911-16 | 26   |
| 11006-18 | 16   | 11013-18 | 15   | 11106-14 | 11   | 11115-32 | 12   | 11704-02 | 271  | 11739-28 | 280  | 11911-18 | 26   |
| 11006-20 | 16   | 11013-20 | 15   | 11106-16 | 11   | 11115-36 | 12   | 11704-06 | 271  | 11739F28 | 521  | 11911-20 | 26   |
| 11006-22 | 16   | 11013-24 | 15   | 11106-20 | 11   | 11115-40 | 12   | 11704-13 | 271  | 11739-32 | 280  | 11913-16 | 26   |
| 11006-24 | 16   | 11013-26 | 15   | 11106-24 | 11   | 11115-45 | 12   | 11704-16 | 271  | 11739F32 | 521  | 11913-20 | 26   |
| 11006-28 | 16   | 11014-20 | 16   | 11106-28 | 11   | 11115-50 | 12   | 11705-02 | 271  | 11740-14 | 281  | 11913-24 | 26   |
| 11006-32 | 16   | 11014F20 | 521  | 11106-32 | 11   | 11117-20 | 12   | 11705-06 | 271  | 11740-16 | 281  | 11913-28 | 26   |
| 11006-36 | 16   | 11014-24 | 16   | 11106-36 | 11   | 11117-24 | 12   | 11705-10 | 271  | 11740-18 | 281  | 11922-36 | 26   |
| 11007-16 | 15   | 11014F24 | 521  | 11107-16 | 11   | 11117-28 | 12   | 11705-14 | 271  | 11740-20 | 281  | 11922-40 | 26   |
| 11007-18 | 15   | 11014-28 | 16   | 11107-20 | 11   | 11117-32 | 12   | 11706-02 | 271  | 11740-22 | 281  | 11924-18 | 109  |
| 11007-20 | 15   | 11014F28 | 521  | 11107-24 | 11   | 11117-36 | 12   | 11706-06 | 271  | 11740-24 | 281  | 11924-20 | 109  |
| 11007-22 | 15   | 11014-32 | 16   | 11107-28 | 11   | 11117-40 | 12   | 11706-10 | 271  | 11740-26 | 281  | 11924F20 | 521  |
| 11007-24 | 15   | 11014F32 | 521  | 11107-32 | 11   | 11119-20 | 11   | 11706-14 | 271  | 11740-28 | 281  | 11924-22 | 109  |
| 11007-28 | 15   | 11014-36 | 16   | 11107-36 | 11   | 11119-24 | 11   | 11710-AA | 33   | 11740-30 | 281  | 11924-24 | 109  |
| 11007-32 | 15   | 11014-40 | 16   | 11107-40 | 11   | 11119-28 | 11   | 11710-AB | 33   | 11740-32 | 281  | 11924-28 | 109  |
| 11007-36 | 15   | 11061-12 | 16   | 11107-45 | 11   | 11119-32 | 11   | 11713-32 | 33   | 11740-36 | 281  | 11926-22 | 109  |
| 11007-40 | 15   | 11061-16 | 16   | 11107-50 | 11   | 11123-20 | 11   | 11713-40 | 33   | 11740-40 | 281  | 11926-26 | 109  |
| 11007-45 | 15   | 11061-18 | 16   | 11108-16 | 12   | 11123-24 | 11   | 11714-20 | 33   | 11741-20 | 280  | 11927-24 | 108  |
| 11007-50 | 15   | 11061-20 | 16   | 11108-20 | 12   | 11123-28 | 11   | 11714-22 | 33   | 11741-24 | 280  | 11927-28 | 108  |
| 11007-60 | 15   | 11061-22 | 16   | 11108-24 | 12   | 11161-12 | 12   | 11714-24 | 33   | 11741-26 | 280  | 11927-32 | 108  |
| 11008-16 | 16   | 11061-24 | 16   | 11108-28 | 12   | 11161-14 | 12   | 11714-26 | 33   | 11741-28 | 280  | 11927-36 | 108  |
| 11008-18 | 16   | 11061-28 | 16   | 11108-32 | 12   | 11161-16 | 12   | 11714-28 | 33   | 11741-32 | 280  | 11927-40 | 108  |
| 11008-20 | 16   | 11061-32 | 16   | 11108-36 | 12   | 11161F16 | 521  | 11714-32 | 33   | 11742-16 | 281  | 11927-45 | 108  |
| 11008-24 | 16   | 11061-36 | 16   | 11109-16 | 11   | 11161-18 | 12   | 11714-36 | 33   | 11742-18 | 281  | 11927-50 | 108  |
| 11008-28 | 16   | 11061-40 | 16   | 11109-20 | 11   | 11161-20 | 12   | 11714-40 | 33   | 11742-20 | 281  | 11928-32 | 108  |
| 11008-32 | 16   | 11061-45 | 16   | 11109-24 | 11   | 11161F20 | 521  | 11714-45 | 33   | 11742-22 | 281  | 11928-36 | 108  |
| 11008-36 | 16   | 11061-50 | 16   | 11109-28 | 11   | 11161-22 | 12   | 11714-50 | 33   | 11742-24 | 281  | 11928-40 | 108  |
| 11009-16 | 15   | 11101-16 | 11   | 11109-32 | 11   | 11161-24 | 12   | 11715-12 | 33   | 11742-26 | 281  | 11929-20 | 112  |
| 11009-18 | 15   | 11101-20 | 11   | 11109-36 | 11   | 11161F24 | 521  | 11716-16 | 33   | 11742-28 | 281  | 11929-24 | 112  |
| 11009-20 | 15   | 11101-24 | 11   | 11109-40 | 11   | 11161-28 | 12   | 11716-20 | 33   | 11742-30 | 281  | 11930-24 | 108  |
| 11009-24 | 15   | 11101-28 | 11   | 11109-45 | 11   | 11161F28 | 521  | 11716-22 | 33   | 11742-32 | 281  | 11930F24 | 521  |
| 11009-28 | 15   | 11101-32 | 11   | 11109-50 | 11   | 11161-32 | 12   | 11716-24 | 33   | 11742-36 | 281  | 11930-28 | 108  |
| 11009-32 | 15   | 11101-36 | 11   | 11112-16 | 12   | 11161-36 | 12   | 11716-26 | 33   | 11742-40 | 281  | 11930-32 | 108  |
| 11009-36 | 15   | 11101-40 | 11   | 11112-18 | 12   | 11161-40 | 12   | 11716-28 | 33   | 11742-45 | 281  | 11930-36 | 108  |
| 11009-40 | 15   | 11101-45 | 11   | 11112-20 | 12   | 11161-45 | 12   | 11716-32 | 33   | 11742-50 | 281  | 11930-40 | 108  |

**NUMERICAL INDEX INDICE NUMERICO NUMERISCH INDEX INDEX NUMERIQUE INDICE NUMERICO**

| Cod.     | pag. | Cod.     | pag. | Cod.     | pag. | Cod.     | pag. | Cod.     | pag. | Cod.     | pag. | Cod.     | pag. |
|----------|------|----------|------|----------|------|----------|------|----------|------|----------|------|----------|------|
| 11930-45 | 108  | 11957-20 | 108  | 11971-20 | 99   | 12007-32 | 18   | 12123F20 | 522  | 12511-24 | 22   | 12550-54 | 390  |
| 11930-50 | 108  | 11957-25 | 108  | 11971-25 | 99   | 12007-36 | 18   | 12123F24 | 522  | 12513-16 | 22   | 12550-55 | 325  |
| 11932-20 | 112  | 11957-30 | 108  | 11972-10 | 99   | 12007-40 | 18   | 12123F28 | 522  | 12513-18 | 22   | 12550-56 | 390  |
| 11932-24 | 112  | 11957-35 | 108  | 11972-12 | 99   | 12007-45 | 18   | 12300-18 | 434  | 12513-20 | 22   | 12550-58 | 389  |
| 11941-35 | 25   | 11957-40 | 108  | 11973-01 | 99   | 12007-50 | 18   | 12300B18 | 435  | 12513-24 | 22   | 12550-60 | 390  |
| 11941-40 | 25   | 11963-99 | 25   | 11973-10 | 99   | 12007-60 | 18   | 12300G18 | 435  | 12514-20 | 23   | 12550-62 | 390  |
| 11941-45 | 25   | 11965-50 | 25   | 11973F10 | 522  | 12009-16 | 18   | 12300O18 | 435  | 12514-24 | 22   | 12550-63 | 390  |
| 11941-50 | 25   | 11965-60 | 25   | 11973-12 | 99   | 12009-18 | 18   | 12300W18 | 434  | 12514-26 | 22   | 12550-64 | 390  |
| 11941-60 | 25   | 11965-61 | 25   | 11973F12 | 522  | 12009-20 | 18   | 12300Y18 | 435  | 12514-28 | 22   | 12550-66 | 390  |
| 11943-40 | 25   | 11966-50 | 525  | 11974-50 | 98   | 12009-24 | 18   | 12300-24 | 434  | 12514-32 | 22   | 12550-68 | 389  |
| 11943-45 | 25   | 11966-60 | 525  | 11974-70 | 98   | 12009-28 | 18   | 12300B24 | 435  | 12514-36 | 22   | 12550-69 | 389  |
| 11943-50 | 25   | 11966-61 | 525  | 11975-01 | 99   | 12009-32 | 18   | 12300G24 | 435  | 12517-24 | 22   | 12550-70 | 389  |
| 11943-60 | 25   | 11967-06 | 98   | 11975-50 | 99   | 12009-36 | 18   | 12300O24 | 435  | 12517-26 | 22   | 12550-73 | 389  |
| 11943-61 | 25   | 11967-08 | 98   | 11975-99 | 99   | 12009-40 | 18   | 12300W24 | 434  | 12517-28 | 22   | 12550-74 | 389  |
| 11944-40 | 25   | 11967-09 | 98   | 11976-50 | 99   | 12009-45 | 18   | 12300Y24 | 435  | 12517-32 | 22   | 12550-77 | 389  |
| 11944-45 | 25   | 11967-10 | 98   | 11976-99 | 99   | 12009-50 | 18   | 12303B16 | 434  | 12517-36 | 22   | 12550-78 | 389  |
| 11944-50 | 25   | 11967-12 | 98   | 11982-01 | 99   | 12009-60 | 18   | 12303G16 | 434  | 12529-32 | 22   | 12550-79 | 389  |
| 11944-60 | 25   | 11967-14 | 98   | 11982-38 | 98   | 12037-16 | 18   | 12303O16 | 434  | 12550-01 | 391  | 12550-80 | 389  |
| 11944-61 | 25   | 11967-16 | 98   | 11982F38 | 522  | 12101-16 | 13   | 12303W16 | 434  | 12550-02 | 390  | 12550-81 | 389  |
| 11948-40 | 25   | 11967-18 | 98   | 11983-37 | 98   | 12101-20 | 13   | 12303Y16 | 434  | 12550-03 | 392  | 12550-83 | 389  |
| 11948-45 | 25   | 11967-20 | 98   | 11983-38 | 98   | 12101-24 | 13   | 12303B20 | 434  | 12550-04 | 318  | 12550-84 | 389  |
| 11948-50 | 25   | 11967-24 | 98   | 11984-38 | 98   | 12101-28 | 13   | 12303G20 | 434  | 12550-05 | 392  | 12550-85 | 389  |
| 11948-60 | 25   | 11968-18 | 98   | 11985-34 | 99   | 12101-32 | 13   | 12303O20 | 434  | 12550-06 | 392  | 12550-87 | 389  |
| 11948-61 | 25   | 11968-20 | 98   | 11990-16 | 100  | 12101-36 | 13   | 12303W20 | 434  | 12550-07 | 392  | 12550-88 | 389  |
| 11951-22 | 110  | 11968-24 | 98   | 11991-16 | 100  | 12101-40 | 13   | 12303Y20 | 434  | 12550-09 | 392  | 12550-89 | 389  |
| 11951-26 | 110  | 11969-02 | 99   | 12001-16 | 18   | 12101-45 | 13   | 12303B24 | 434  | 12550-11 | 390  | 12550-91 | 389  |
| 11951-32 | 110  | 11969-06 | 98   | 12001-18 | 18   | 12101-50 | 13   | 12303G24 | 434  | 12550-12 | 390  | 12561-12 | 23   |
| 11951-36 | 110  | 11969-37 | 98   | 12001-20 | 18   | 12107-16 | 13   | 12303O24 | 434  | 12550-13 | 390  | 12561-16 | 23   |
| 11951-40 | 110  | 11970-01 | 99   | 12001F20 | 522  | 12107-20 | 13   | 12303W24 | 434  | 12550-14 | 390  | 12561-18 | 23   |
| 11952-22 | 110  | 11970-06 | 98   | 12001-22 | 18   | 12107-24 | 13   | 12303Y24 | 434  | 12550-15 | 391  | 12561-20 | 23   |
| 11952-26 | 110  | 11970F06 | 522  | 12001-24 | 18   | 12107-28 | 13   | 12304B26 | 434  | 12550-16 | 391  | 12561-24 | 23   |
| 11952-32 | 110  | 11970-08 | 98   | 12001F24 | 522  | 12107-32 | 13   | 12304G26 | 434  | 12550-17 | 391  | 12561-26 | 23   |
| 11952-36 | 110  | 11970F08 | 522  | 12001-28 | 18   | 12107-36 | 13   | 12304O26 | 434  | 12550-18 | 391  | 12561-28 | 23   |
| 11952-40 | 110  | 11970-09 | 98   | 12001F28 | 522  | 12107-40 | 13   | 12304W26 | 434  | 12550-19 | 392  | 12580-11 | 108  |
| 11953-16 | 110  | 11970-10 | 98   | 12001-32 | 18   | 12107-45 | 13   | 12304Y26 | 434  | 12550-20 | 391  | 12580-17 | 108  |
| 11953-22 | 110  | 11970F10 | 522  | 12001-36 | 18   | 12107-50 | 13   | 12504-20 | 103  | 12550-21 | 391  | 12580-21 | 108  |
| 11954-26 | 110  | 11970-11 | 98   | 12001-40 | 18   | 12109-16 | 13   | 12507-24 | 22   | 12550-22 | 390  | 12580-24 | 108  |
| 11954-30 | 110  | 11970-12 | 98   | 12001-45 | 18   | 12109-20 | 13   | 12507-28 | 22   | 12550-23 | 390  | 12580-29 | 108  |
| 11954-32 | 110  | 11970-14 | 98   | 12001-50 | 18   | 12109-24 | 13   | 12508-24 | 22   | 12550-24 | 391  | 12580-30 | 108  |
| 11954-36 | 110  | 11970-16 | 98   | 12001-60 | 18   | 12109-28 | 13   | 12509-12 | 23   | 12550-25 | 391  | 12580-31 | 108  |
| 11954-37 | 110  | 11971-01 | 100  | 12007-16 | 18   | 12109-32 | 13   | 12509-20 | 22   | 12550-26 | 391  | 12580-36 | 108  |
| 11954-40 | 110  | 11971-08 | 99   | 12007F16 | 522  | 12109-36 | 13   | 12509-24 | 22   | 12550-30 | 391  | 12580-40 | 108  |
| 11955-32 | 108  | 11971-10 | 99   | 12007-18 | 18   | 12109-40 | 13   | 12509-28 | 22   | 12550-33 | 391  | 12580-45 | 108  |
| 11955-36 | 108  | 11971F10 | 522  | 12007-20 | 18   | 12109-45 | 13   | 12511-10 | 23   | 12550-34 | 390  | 12580-50 | 108  |
| 11955-40 | 108  | 11971-12 | 99   | 12007-22 | 18   | 12109-50 | 13   | 12511-12 | 23   | 12550-36 | 325  | 12582-13 | 108  |
| 11955-45 | 108  | 11971F12 | 522  | 12007-24 | 18   | 12119-20 | 18   | 12511-14 | 23   | 12550-37 | 391  | 12582-17 | 108  |
| 11955-50 | 108  | 11971-14 | 99   | 12007F24 | 522  | 12119-24 | 18   | 12511-16 | 22   | 12550-43 | 392  | 12582-22 | 108  |
| 11956-37 | 408  | 11971-16 | 99   | 12007-28 | 18   | 12119-28 | 18   | 12511-18 | 22   | 12550-50 | 389  | 12582-24 | 108  |
| 11956-42 | 408  | 11971-18 | 99   | 12007F28 | 522  | 12119-32 | 18   | 12511-20 | 22   | 12550-53 | 390  | 12582-32 | 108  |

| Cod.     | pag. | Cod.     | pag. | Cod.     | pag. | Cod.     | pag. | Cod.     | pag. | Cod.     | pag. | Cod.     | pag. |
|----------|------|----------|------|----------|------|----------|------|----------|------|----------|------|----------|------|
| 12582-34 | 108  | 12642-28 | 101  | 12929-30 | 82   | 12947-04 | 180  | 14101-20 | 52   | 14107-20 | 53   | 14151-15 | 55   |
| 12582-38 | 108  | 12903-30 | 79   | 12929F30 | 523  | 12947-05 | 180  | 14102-02 | 52   | 14107F20 | 523  | 14151-20 | 55   |
| 12582-40 | 108  | 12903-40 | 79   | 12929-35 | 82   | 12947-06 | 180  | 14102F02 | 523  | 14108-06 | 53   | 14152-06 | 55   |
| 12604-22 | 107  | 12903-45 | 79   | 12929F35 | 523  | 12947-07 | 180  | 14102-04 | 52   | 14108F06 | 523  | 14152-10 | 55   |
| 12604-30 | 107  | 12905-25 | 79   | 12929-40 | 82   | 12947-13 | 180  | 14102F04 | 523  | 14108-10 | 53   | 14152-15 | 55   |
| 12604-34 | 107  | 12905-30 | 79   | 12929-45 | 82   | 12950-32 | 82   | 14102-06 | 52   | 14108F10 | 523  | 14152-20 | 55   |
| 12604-40 | 107  | 12905-35 | 79   | 12930-51 | 80   | 12950-40 | 82   | 14102F06 | 523  | 14108-15 | 53   | 14155-10 | 55   |
| 12605-22 | 107  | 12905-40 | 79   | 12930-52 | 80   | 12967-06 | 81   | 14102-10 | 52   | 14108F15 | 523  | 14155-15 | 55   |
| 12605-30 | 107  | 12905-45 | 79   | 12930-62 | 80   | 12967-10 | 81   | 14102F10 | 523  | 14108-20 | 53   | 14155-20 | 55   |
| 12605-34 | 107  | 12905-50 | 79   | 12930-63 | 80   | 12968-10 | 81   | 14102-15 | 52   | 14108F20 | 523  | 14157-10 | 55   |
| 12605-40 | 107  | 12906-35 | 79   | 12930-68 | 80   | 12969-06 | 81   | 14102F15 | 523  | 14109-06 | 53   | 14157-15 | 55   |
| 12606-30 | 107  | 12907-07 | 79   | 12930-69 | 80   | 12969-10 | 81   | 14102-20 | 52   | 14109F06 | 523  | 14157-20 | 55   |
| 12606-34 | 107  | 12907-08 | 79   | 12930-74 | 80   | 12970-06 | 81   | 14102F20 | 523  | 14109-10 | 53   | 14158-10 | 55   |
| 12607-22 | 107  | 12908-30 | 79   | 12930-77 | 80   | 12970-08 | 81   | 14103-02 | 53   | 14109F10 | 523  | 14158-15 | 55   |
| 12607-30 | 107  | 12908-35 | 79   | 12930-78 | 80   | 12970-10 | 81   | 14103F02 | 523  | 14109-15 | 53   | 14158-20 | 55   |
| 12607-34 | 107  | 12908-40 | 79   | 12931-51 | 81   | 12970-12 | 81   | 14103-04 | 53   | 14109F15 | 523  | 14159-10 | 55   |
| 12622-07 | 111  | 12909-12 | 79   | 12931-53 | 81   | 12971-10 | 81   | 14103F04 | 523  | 14109-20 | 53   | 14159-15 | 55   |
| 12622-10 | 111  | 12909-23 | 79   | 12932-22 | 82   | 12971-12 | 81   | 14103-06 | 53   | 14109F20 | 523  | 14159-20 | 55   |
| 12622-12 | 111  | 12915-25 | 79   | 12932-26 | 82   | 12972-10 | 81   | 14103F06 | 523  | 14110-06 | 53   | 14162-02 | 55   |
| 12622-14 | 111  | 12915-26 | 79   | 12940-02 | 107  | 12972-12 | 81   | 14103-10 | 53   | 14110F06 | 523  | 14162-04 | 55   |
| 12622-16 | 111  | 12915-35 | 79   | 12940-05 | 107  | 12973-10 | 81   | 14103F10 | 523  | 14110-10 | 53   | 14162-06 | 55   |
| 12622-18 | 111  | 12915-45 | 79   | 12940-10 | 107  | 12973-12 | 81   | 14103-15 | 53   | 14110F10 | 523  | 14165-02 | 55   |
| 12622-20 | 111  | 12916-25 | 79   | 12940-20 | 107  | 12986-01 | 81   | 14103F15 | 523  | 14112-10 | 53   | 14165-04 | 55   |
| 12622-23 | 111  | 12916-33 | 79   | 12940-25 | 107  | 12986-38 | 81   | 14103-20 | 53   | 14112-15 | 53   | 14165-06 | 55   |
| 12622-26 | 111  | 12917-25 | 79   | 12941-07 | 82   | 12992-36 | 26   | 14103F20 | 523  | 14112-20 | 53   | 14201-02 | 56   |
| 12630-22 | 111  | 12920-01 | 80   | 12941-10 | 82   | 12992-40 | 26   | 14104-06 | 53   | 14115-10 | 54   | 14201-04 | 56   |
| 12633-16 | 111  | 12920-05 | 80   | 12941-12 | 82   | 14001-09 | 460  | 14104F06 | 523  | 14115-15 | 54   | 14201-06 | 56   |
| 12633-18 | 111  | 12920-10 | 80   | 12941-14 | 82   | 14001-16 | 460  | 14104-10 | 53   | 14115-20 | 54   | 14201-10 | 56   |
| 12633-20 | 111  | 12920-11 | 80   | 12941-16 | 82   | 14001-25 | 460  | 14104F10 | 523  | 14117-10 | 54   | 14201-15 | 56   |
| 12633-23 | 111  | 12920-15 | 80   | 12941-18 | 82   | 14001-36 | 460  | 14104-15 | 53   | 14117-15 | 54   | 14201-20 | 56   |
| 12633-26 | 111  | 12920-16 | 80   | 12941-20 | 82   | 14001-49 | 460  | 14104F15 | 523  | 14117-20 | 54   | 14202-02 | 56   |
| 12635-23 | 111  | 12921-01 | 79   | 12941-23 | 82   | 14003-09 | 460  | 14105-02 | 53   | 14118-10 | 54   | 14202-04 | 56   |
| 12635-26 | 111  | 12921-05 | 79   | 12941-26 | 82   | 14003-16 | 460  | 14105F02 | 523  | 14118-15 | 54   | 14202-06 | 56   |
| 12635-30 | 111  | 12921-10 | 79   | 12943-03 | 112  | 14003-25 | 460  | 14105-04 | 53   | 14118-20 | 54   | 14202-10 | 56   |
| 12635-35 | 111  | 12921-15 | 80   | 12943-05 | 112  | 14003-36 | 460  | 14105F04 | 523  | 14119-10 | 54   | 14202-15 | 56   |
| 12636-32 | 111  | 12926-35 | 82   | 12943-07 | 112  | 14003-49 | 461  | 14105-06 | 53   | 14119-15 | 54   | 14202-20 | 56   |
| 12638-20 | 111  | 12927-35 | 82   | 12943-08 | 112  | 14004-00 | 461  | 14105F06 | 523  | 14142-10 | 54   | 14203-06 | 56   |
| 12640-14 | 101  | 12927-45 | 82   | 12943-10 | 112  | 14006-00 | 461  | 14105-10 | 53   | 14142-15 | 54   | 14203-10 | 56   |
| 12640-16 | 101  | 12928-25 | 82   | 12943-12 | 112  | 14007-00 | 461  | 14105F10 | 523  | 14142-20 | 54   | 14203-15 | 56   |
| 12640-18 | 101  | 12928-30 | 82   | 12943-13 | 180  | 14008-00 | 461  | 14105-15 | 53   | 14145-10 | 54   | 14203-20 | 56   |
| 12640-20 | 101  | 12928F30 | 522  | 12944-03 | 112  | 14010-00 | 461  | 14105F15 | 523  | 14145-15 | 54   | 14205-02 | 56   |
| 12640-24 | 101  | 12928-35 | 82   | 12944-05 | 112  | 14011-00 | 461  | 14105-20 | 53   | 14145-20 | 54   | 14205-04 | 56   |
| 12640-28 | 101  | 12928F35 | 522  | 12944-07 | 112  | 14013-00 | 461  | 14105F20 | 523  | 14147-10 | 54   | 14205-06 | 56   |
| 12641-14 | 101  | 12928-40 | 82   | 12944-08 | 112  | 14015-08 | 461  | 14107-06 | 53   | 14147-15 | 54   | 14205-10 | 56   |
| 12641-16 | 101  | 12928-45 | 82   | 12944-10 | 112  | 14101-02 | 52   | 14107F06 | 523  | 14147-20 | 54   | 14205-15 | 56   |
| 12641-18 | 101  | 12928-50 | 82   | 12944-12 | 112  | 14101-04 | 52   | 14107-10 | 53   | 14148-10 | 54   | 14205-20 | 56   |
| 12641-20 | 101  | 12928-55 | 82   | 12944-13 | 180  | 14101-06 | 52   | 14107F10 | 523  | 14148-15 | 54   | 14252-06 | 56   |
| 12641-24 | 101  | 12928-60 | 82   | 12947-02 | 180  | 14101-10 | 52   | 14107-15 | 53   | 14148-20 | 54   | 14252-10 | 56   |
| 12641-28 | 101  | 12929-25 | 82   | 12947-03 | 180  | 14101-15 | 52   | 14107F15 | 523  | 14151-10 | 55   | 14252-15 | 56   |



**NUMERICAL INDEX INDICE NUMERICO NUMERISCH INDEX INDEX NUMERIQUE INDICE NUMERICO**

| Cod.     | pag. | Cod.     | pag. | Cod.     | pag. | Cod.     | pag. | Cod.     | pag. | Cod.     | pag. | Cod.     | pag. |
|----------|------|----------|------|----------|------|----------|------|----------|------|----------|------|----------|------|
| 14252-20 | 56   | 14519-00 | 57   | 14579-00 | 62   | 14702-10 | 66   | 14729-33 | 67   | 14958-02 | 318  | 15343-36 | 38   |
| 14255-06 | 56   | 14522-00 | 57   | 14580-00 | 62   | 14702-15 | 66   | 14729-99 | 67   | 15100-01 | 71   | 15401-51 | 38   |
| 14255-10 | 56   | 14523-00 | 57   | 14585-00 | 62   | 14702-20 | 66   | 14730-00 | 67   | 15100-02 | 71   | 15403-16 | 38   |
| 14255-15 | 56   | 14525-00 | 57   | 14591-00 | 62   | 14705-06 | 66   | 14730-11 | 67   | 15100-03 | 71   | 15406-16 | 38   |
| 14255-20 | 56   | 14527-00 | 57   | 14592-00 | 62   | 14705-10 | 66   | 14730-22 | 67   | 15100-04 | 71   | 15406-20 | 38   |
| 14301-02 | 58   | 14528-00 | 57   | 14595-00 | 62   | 14705-15 | 66   | 14730-33 | 67   | 15100-07 | 71   | 15407-16 | 38   |
| 14301-04 | 58   | 14529-00 | 57   | 14597-00 | 62   | 14705-20 | 66   | 14730-99 | 67   | 15100-AA | 71   | 15407-20 | 38   |
| 14301-06 | 58   | 14532-00 | 57   | 14598-00 | 62   | 14707-06 | 66   | 14912-00 | 69   | 15101-06 | 69   | 15409-26 | 38   |
| 14302-02 | 58   | 14535-00 | 57   | 14599-00 | 62   | 14707-10 | 66   | 14915-00 | 69   | 15101-10 | 69   | 15409-30 | 38   |
| 14302-04 | 58   | 14537-00 | 57   | 14661-20 | 63   | 14707-15 | 66   | 14922-00 | 70   | 15101-15 | 69   | 15409-36 | 38   |
| 14302-06 | 58   | 14538-00 | 57   | 14662-06 | 63   | 14707-20 | 66   | 14922-11 | 70   | 15101-20 | 69   | 15415-03 | 38   |
| 14303-02 | 58   | 14539-00 | 57   | 14662-10 | 63   | 14708-06 | 66   | 14922-22 | 70   | 15105-06 | 69   | 15428-06 | 364  |
| 14303-04 | 58   | 14542-00 | 57   | 14662-15 | 63   | 14708-10 | 66   | 14922-33 | 70   | 15105-10 | 69   | 15430-11 | 38   |
| 14303-06 | 58   | 14543-00 | 57   | 14662-20 | 63   | 14708-15 | 66   | 14922-77 | 70   | 15105-15 | 69   | 15438-50 | 38   |
| 14305-02 | 58   | 14545-00 | 57   | 14665-06 | 63   | 14708-20 | 66   | 14922-99 | 70   | 15105-20 | 69   | 15506-16 | 35   |
| 14305-04 | 58   | 14547-00 | 57   | 14665-10 | 63   | 14709-06 | 66   | 14925-00 | 70   | 15107-06 | 69   | 15506-20 | 35   |
| 14305-06 | 58   | 14548-00 | 57   | 14665-15 | 63   | 14709-10 | 66   | 14925-11 | 70   | 15107-10 | 69   | 15506-24 | 35   |
| 14362-02 | 58   | 14549-00 | 57   | 14665-20 | 63   | 14709-15 | 66   | 14925-22 | 70   | 15107-15 | 69   | 15506-28 | 35   |
| 14362-04 | 58   | 14552-00 | 58   | 14667-06 | 64   | 14709-20 | 66   | 14925-33 | 70   | 15107-20 | 69   | 15507-16 | 35   |
| 14362-06 | 58   | 14555-00 | 58   | 14667-10 | 64   | 14710-06 | 66   | 14925-77 | 70   | 15108-06 | 69   | 15507-20 | 35   |
| 14365-02 | 58   | 14561-15 | 61   | 14667-15 | 64   | 14710-10 | 66   | 14925-99 | 70   | 15108-10 | 69   | 15507-24 | 35   |
| 14365-04 | 58   | 14561-20 | 61   | 14667-20 | 64   | 14712-00 | 66   | 14927-00 | 70   | 15108-15 | 69   | 15507-28 | 35   |
| 14365-06 | 58   | 14562-06 | 61   | 14668-06 | 64   | 14715-00 | 66   | 14927-11 | 70   | 15108-20 | 69   | 15508-20 | 35   |
| 14402-00 | 60   | 14562-10 | 61   | 14668-10 | 64   | 14717-00 | 66   | 14927-22 | 70   | 15109-06 | 69   | 15508-24 | 35   |
| 14405-00 | 60   | 14562-15 | 61   | 14668-15 | 64   | 14718-00 | 66   | 14927-33 | 70   | 15109-10 | 69   | 15508-28 | 35   |
| 14407-00 | 60   | 14562-20 | 61   | 14668-20 | 64   | 14719-00 | 66   | 14927-77 | 70   | 15109-15 | 69   | 15509-20 | 35   |
| 14409-01 | 60   | 14565-06 | 61   | 14669-06 | 64   | 14722-00 | 67   | 14927-99 | 70   | 15109-20 | 69   | 15509-24 | 35   |
| 14409-02 | 60   | 14565-10 | 61   | 14669-10 | 64   | 14722-11 | 67   | 14928-00 | 70   | 15110-06 | 69   | 15509-28 | 35   |
| 14480-20 | 325  | 14565-15 | 61   | 14669-15 | 64   | 14722-22 | 67   | 14928-11 | 70   | 15110-10 | 69   | 15514-20 | 35   |
| 14502-00 | 57   | 14565-20 | 61   | 14669-20 | 64   | 14722-33 | 67   | 14928-22 | 70   | 15224-10 | 36   | 15514-24 | 35   |
| 14502F00 | 523  | 14567-06 | 62   | 14670-06 | 64   | 14722-99 | 67   | 14928-33 | 70   | 15224-12 | 36   | 15514-28 | 35   |
| 14503-00 | 57   | 14567-10 | 62   | 14670-10 | 64   | 14725-00 | 67   | 14928-77 | 70   | 15224-14 | 36   | 15514-32 | 35   |
| 14503F00 | 523  | 14567-15 | 62   | 14671-00 | 64   | 14725-11 | 67   | 14928-99 | 70   | 15225-10 | 36   | 15515-20 | 35   |
| 14504-00 | 57   | 14567-20 | 62   | 14672-00 | 64   | 14725-22 | 67   | 14929-00 | 70   | 15225-12 | 36   | 15515-24 | 35   |
| 14504F00 | 523  | 14568-06 | 62   | 14675-00 | 64   | 14725-33 | 67   | 14929-11 | 70   | 15225-14 | 36   | 15515-28 | 35   |
| 14505-00 | 57   | 14568-10 | 62   | 14677-00 | 64   | 14725-99 | 67   | 14929-22 | 70   | 15226-07 | 36   | 15515-32 | 35   |
| 14505F00 | 523  | 14568-15 | 62   | 14678-00 | 64   | 14727-00 | 67   | 14929-33 | 70   | 15226-10 | 36   | 15561-20 | 35   |
| 14507-00 | 57   | 14568-20 | 62   | 14679-00 | 64   | 14727-11 | 67   | 14929-77 | 70   | 15226-12 | 36   | 15561-24 | 35   |
| 14507F00 | 523  | 14569-06 | 62   | 14680-00 | 64   | 14727-22 | 67   | 14929-99 | 70   | 15226-14 | 36   | 15561-28 | 35   |
| 14508-00 | 57   | 14569-10 | 62   | 14682-00 | 64   | 14727-33 | 67   | 14930-00 | 70   | 15227-10 | 36   | 16101-16 | 28   |
| 14508F00 | 523  | 14569-15 | 62   | 14685-00 | 64   | 14727-99 | 67   | 14930-11 | 70   | 15227-12 | 36   | 16101-20 | 28   |
| 14509-00 | 57   | 14569-20 | 62   | 14687-00 | 64   | 14728-00 | 67   | 14930-22 | 70   | 15227-14 | 36   | 16101-24 | 28   |
| 14509F00 | 523  | 14570-06 | 62   | 14688-00 | 64   | 14728-11 | 67   | 14930-33 | 70   | 15228-10 | 36   | 16101-28 | 28   |
| 14510-00 | 57   | 14570-10 | 62   | 14689-00 | 64   | 14728-22 | 67   | 14930-77 | 70   | 15229-10 | 36   | 16101-32 | 28   |
| 14510F00 | 523  | 14571-00 | 62   | 14690-00 | 64   | 14728-33 | 67   | 14930-99 | 70   | 15261-10 | 36   | 16101-36 | 28   |
| 14512-00 | 57   | 14572-00 | 62   | 14691-00 | 64   | 14728-99 | 67   | 14942-99 | 69   | 15261-12 | 36   | 16101-40 | 28   |
| 14515-00 | 57   | 14575-00 | 62   | 14692-00 | 64   | 14729-00 | 67   | 14945-99 | 69   | 15261-14 | 36   | 16101-45 | 28   |
| 14517-00 | 57   | 14577-00 | 62   | 14695-00 | 64   | 14729-11 | 67   | 14947-99 | 69   | 15338-38 | 38   | 16101-50 | 28   |
| 14518-00 | 57   | 14578-00 | 62   | 14702-06 | 66   | 14729-22 | 67   | 14958-01 | 318  | 15339-36 | 38   | 16106-16 | 28   |

| Cod.     | pag. | Cod.     | pag. | Cod.     | pag. | Cod.     | pag. | Cod.     | pag. | Cod.     | pag. | Cod.     | pag. |
|----------|------|----------|------|----------|------|----------|------|----------|------|----------|------|----------|------|
| 16106-20 | 28   | 16117-36 | 29   | 16910-14 | 31   | 16948-40 | 30   | 18000B30 | 141  | 18006R30 | 143  | 18015-27 | 145  |
| 16106-24 | 28   | 16117-40 | 29   | 16910-16 | 31   | 16948-45 | 30   | 18000G30 | 141  | 18006Y30 | 143  | 18015Y27 | 145  |
| 16106-28 | 28   | 16118-24 | 30   | 16910-18 | 31   | 16948-50 | 30   | 18000R30 | 141  | 18006-36 | 143  | 18016-14 | 145  |
| 16107-16 | 28   | 16120-24 | 29   | 16910-20 | 31   | 16948-60 | 30   | 18000W30 | 141  | 18007-25 | 143  | 18016B14 | 145  |
| 16107-20 | 28   | 16120-28 | 29   | 16923-32 | 28   | 16948-61 | 30   | 18000-36 | 141  | 18007-30 | 143  | 18016R14 | 145  |
| 16107-24 | 28   | 16120-32 | 29   | 16923-36 | 28   | 16961-16 | 29   | 18002-18 | 142  | 18007G30 | 143  | 18016Y14 | 146  |
| 16107-28 | 28   | 16120-36 | 29   | 16923-40 | 28   | 16961-20 | 29   | 18002R18 | 142  | 18007-36 | 143  | 18016-16 | 145  |
| 16107-32 | 28   | 16120-40 | 29   | 16924-20 | 109  | 16961-24 | 29   | 18002Y18 | 142  | 18008-20 | 143  | 18016B16 | 145  |
| 16107-36 | 28   | 16127-16 | 29   | 16924-24 | 109  | 16961-28 | 29   | 18002-20 | 142  | 18008-26 | 143  | 18016R16 | 145  |
| 16107-40 | 28   | 16127-20 | 29   | 16924-28 | 109  | 16961-32 | 29   | 18002R20 | 142  | 18008R26 | 143  | 18016W16 | 146  |
| 16107-45 | 28   | 16127-24 | 29   | 16926-32 | 28   | 16961-36 | 29   | 18002-22 | 142  | 18008-30 | 143  | 18016Y16 | 146  |
| 16107-50 | 28   | 16127-28 | 29   | 16926-36 | 28   | 16961-40 | 29   | 18002R22 | 142  | 18008B30 | 143  | 18017-14 | 146  |
| 16108-20 | 28   | 16127-32 | 29   | 16926-40 | 28   | 16961-45 | 29   | 18002-26 | 142  | 18008R30 | 143  | 18017-16 | 146  |
| 16108-24 | 28   | 16127-36 | 29   | 16927-32 | 108  | 16961-50 | 29   | 18002B26 | 142  | 18008Y30 | 144  | 18017B16 | 146  |
| 16108-28 | 28   | 16127-40 | 29   | 16927-36 | 108  | 16961-60 | 29   | 18002R26 | 142  | 18008-36 | 143  | 18017R16 | 146  |
| 16109-24 | 28   | 16134-12 | 39   | 16927-40 | 108  | 16965-40 | 31   | 18002Y26 | 142  | 18008R36 | 143  | 18017Y16 | 146  |
| 16109-28 | 28   | 16135-12 | 39   | 16927-45 | 108  | 16965-50 | 31   | 18002-30 | 142  | 18009-25 | 144  | 18017-18 | 146  |
| 16109-32 | 28   | 16136-10 | 39   | 16927-50 | 108  | 16965-60 | 31   | 18002R30 | 142  | 18009B25 | 144  | 18018-11 | 146  |
| 16109-36 | 28   | 16137-10 | 39   | 16929-36 | 31   | 17610-01 | 107  | 18002Y30 | 142  | 18009G25 | 144  | 18018R11 | 146  |
| 16109-40 | 28   | 16138-10 | 39   | 16929-40 | 31   | 17610-02 | 107  | 18002-36 | 142  | 18009M25 | 144  | 18018Y11 | 146  |
| 16109-45 | 28   | 16139-10 | 39   | 16938-36 | 28   | 17610-05 | 107  | 18002R36 | 142  | 18009R25 | 144  | 18019-12 | 146  |
| 16109-50 | 28   | 16302-02 | 59   | 16938-40 | 28   | 17610-10 | 107  | 18002Y36 | 142  | 18009W25 | 144  | 18019R12 | 146  |
| 16109-60 | 28   | 16302-04 | 59   | 16938-45 | 28   | 18000-16 | 141  | 18005-22 | 141  | 18009Y25 | 144  | 18019-14 | 146  |
| 16113-20 | 30   | 16302-06 | 59   | 16939-50 | 31   | 18000B16 | 141  | 18005B22 | 142  | 18009-30 | 144  | 18019-16 | 146  |
| 16113-24 | 30   | 16303-02 | 59   | 16939-60 | 31   | 18000G16 | 141  | 18005G22 | 142  | 18009B30 | 144  | 18019R16 | 146  |
| 16113-28 | 30   | 16303-04 | 59   | 16939-70 | 31   | 18000M16 | 141  | 18005R22 | 142  | 18009G30 | 144  | 18019-18 | 146  |
| 16113-32 | 30   | 16303-06 | 59   | 16939-80 | 31   | 18000R16 | 141  | 18005Y22 | 142  | 18009R30 | 144  | 18019R18 | 146  |
| 16113-36 | 30   | 16305-02 | 59   | 16940-28 | 210  | 18000Y16 | 141  | 18005-27 | 141  | 18009W30 | 144  | 18019-20 | 146  |
| 16113-40 | 30   | 16305-04 | 59   | 16940-32 | 210  | 18000-20 | 141  | 18005B27 | 142  | 18009Y30 | 144  | 18019R20 | 146  |
| 16114-20 | 29   | 16305-06 | 59   | 16940-36 | 210  | 18000B20 | 141  | 18005G27 | 142  | 18009-36 | 144  | 18020-23 | 146  |
| 16114-24 | 29   | 16362-02 | 59   | 16940-40 | 210  | 18000G20 | 141  | 18005R27 | 142  | 18010-25 | 144  | 18020B23 | 146  |
| 16114-28 | 29   | 16362-04 | 59   | 16941-40 | 30   | 18000M20 | 141  | 18005Y27 | 142  | 18010-30 | 144  | 18020R23 | 146  |
| 16114-32 | 29   | 16362-06 | 59   | 16941-45 | 30   | 18000R20 | 141  | 18005-32 | 141  | 18010Y30 | 145  | 18021-18 | 146  |
| 16114-36 | 29   | 16363-02 | 59   | 16941-50 | 30   | 18000W20 | 141  | 18005B32 | 142  | 18010-36 | 144  | 18021B18 | 146  |
| 16114-40 | 29   | 16363-04 | 59   | 16941-60 | 30   | 18000Y20 | 141  | 18005G32 | 142  | 18011-32 | 144  | 18021R18 | 146  |
| 16115-24 | 29   | 16363-06 | 59   | 16941-61 | 30   | 18000-23 | 141  | 18005R32 | 142  | 18012-32 | 145  | 18022-12 | 146  |
| 16115-28 | 29   | 16365-02 | 59   | 16943-40 | 30   | 18000B23 | 141  | 18005Y32 | 142  | 18012B32 | 145  | 18023-11 | 147  |
| 16115-32 | 29   | 16365-04 | 59   | 16943-45 | 30   | 18000G23 | 141  | 18006-20 | 143  | 18013-30 | 145  | 18024-08 | 147  |
| 16115-36 | 29   | 16365-06 | 59   | 16943-50 | 30   | 18000M23 | 141  | 18006B20 | 143  | 18013W30 | 145  | 18024B08 | 147  |
| 16115-40 | 29   | 16712-22 | 30   | 16943-60 | 30   | 18000R23 | 141  | 18006G20 | 143  | 18013-36 | 145  | 18024G08 | 147  |
| 16115-45 | 29   | 16712-26 | 30   | 16943-61 | 30   | 18000Y23 | 141  | 18006R20 | 143  | 18013G36 | 145  | 18024M08 | 147  |
| 16116-28 | 29   | 16712-30 | 30   | 16944-45 | 31   | 18000-26 | 141  | 18006Y20 | 143  | 18013W36 | 145  | 18024R08 | 147  |
| 16116-32 | 29   | 16717-20 | 30   | 16944-50 | 31   | 18000B26 | 141  | 18006-25 | 143  | 18015-18 | 145  | 18024W08 | 147  |
| 16116-36 | 29   | 16717-24 | 30   | 16944-60 | 31   | 18000G26 | 141  | 18006B25 | 143  | 18015B18 | 145  | 18024Y08 | 147  |
| 16116-40 | 29   | 16717-28 | 30   | 16947-40 | 30   | 18000M26 | 141  | 18006G25 | 143  | 18015R18 | 145  | 18024-11 | 147  |
| 16117-20 | 29   | 16717-32 | 30   | 16947-45 | 30   | 18000R26 | 141  | 18006R25 | 143  | 18015Y18 | 145  | 18024B11 | 147  |
| 16117-24 | 29   | 16717-36 | 30   | 16947-50 | 30   | 18000W26 | 141  | 18006Y25 | 143  | 18015-22 | 145  | 18024G11 | 147  |
| 16117-28 | 29   | 16717-40 | 30   | 16947-60 | 30   | 18000Y26 | 141  | 18006-30 | 143  | 18015B22 | 145  | 18024M11 | 147  |
| 16117-32 | 29   | 16719-12 | 30   | 16947-61 | 30   | 18000-30 | 141  | 18006B30 | 143  | 18015R22 | 145  | 18024R11 | 147  |

**NUMERICAL INDEX INDICE NUMERICO NUMERISCH INDEX INDEX NUMERIQUE INDICE NUMERICO**

| Cod.     | pag. | Cod.     | pag. | Cod.     | pag. | Cod.     | pag. | Cod.     | pag. | Cod.     | pag. | Cod.     | pag. |
|----------|------|----------|------|----------|------|----------|------|----------|------|----------|------|----------|------|
| 18024W11 | 147  | 18109-26 | 138  | 18136-EB | 447  | 18166U36 | 440  | 18176I30 | 437  | 18221R17 | 150  | 18275-00 | 154  |
| 18026-07 | 147  | 18109-30 | 138  | 18136-KA | 448  | 18166-40 | 437  | 18176-36 | 437  | 18221Y17 | 150  | 18276-00 | 155  |
| 18026B07 | 147  | 18109-36 | 138  | 18136-KE | 449  | 18166A40 | 440  | 18176A36 | 440  | 18221-19 | 150  | 18277-00 | 117  |
| 18026G07 | 147  | 18110-26 | 138  | 18136-KP | 526  | 18166E40 | 440  | 18176E36 | 440  | 18221B19 | 150  | 18278-00 | 154  |
| 18026M07 | 147  | 18110-30 | 138  | 18136-KQ | 525  | 18166I40 | 437  | 18176I36 | 437  | 18221G19 | 150  | 18279-14 | 154  |
| 18028-21 | 148  | 18110-36 | 138  | 18136-KR | 526  | 18166U40 | 440  | 18176U36 | 440  | 18221M19 | 150  | 18280-10 | 157  |
| 18028F21 | 523  | 18111-30 | 138  | 18136-KU | 449  | 18166-AA | 447  | 18176-40 | 437  | 18221R19 | 150  | 18280-16 | 157  |
| 18028W21 | 148  | 18112-30 | 138  | 18152A54 | 443  | 18166-AB | 447  | 18176A40 | 440  | 18221Y19 | 150  | 18280-22 | 157  |
| 18028-25 | 148  | 18114-20 | 138  | 18152E54 | 443  | 18166-AC | 447  | 18176E40 | 440  | 18221-21 | 150  | 18281-24 | 157  |
| 18028F25 | 523  | 18115-20 | 139  | 18152U54 | 443  | 18166-AD | 526  | 18176I40 | 437  | 18221B21 | 150  | 18282-18 | 157  |
| 18028M25 | 148  | 18115-25 | 139  | 18156A33 | 443  | 18166-AE | 526  | 18176U40 | 440  | 18221G21 | 150  | 18282-19 | 157  |
| 18028W25 | 148  | 18116-14 | 139  | 18156E33 | 443  | 18166-AF | 526  | 18176-AE | 526  | 18221M21 | 150  | 18282-22 | 157  |
| 18028Y25 | 148  | 18116-18 | 139  | 18156U33 | 443  | 18166-AH | 526  | 18176-AF | 526  | 18221R21 | 150  | 18283-27 | 157  |
| 18028-30 | 148  | 18122-12 | 139  | 18156A40 | 443  | 18166-AM | 447  | 18176-AH | 526  | 18221Y21 | 150  | 18283-33 | 157  |
| 18028B30 | 148  | 18123-11 | 139  | 18156E40 | 443  | 18166-EB | 448  | 18190-09 | 159  | 18222-18 | 152  | 18284-21 | 157  |
| 18028F30 | 523  | 18124-09 | 139  | 18156U40 | 443  | 18166-EC | 448  | 18190-AA | 526  | 18224-28 | 151  | 18284-27 | 157  |
| 18028W30 | 148  | 18125-07 | 139  | 18162-54 | 438  | 18166-ED | 448  | 18191-22 | 159  | 18224B28 | 151  | 18284-30 | 157  |
| 18028Y30 | 148  | 18125-10 | 139  | 18162A54 | 441  | 18166-EG | 447  | 18192-09 | 159  | 18224R28 | 151  | 18284-33 | 157  |
| 18028-36 | 148  | 18126-07 | 139  | 18162E54 | 441  | 18166-EH | 447  | 18199-19 | 158  | 18224Y28 | 151  | 18301-01 | 274  |
| 18028F36 | 523  | 18128-20 | 139  | 18162U54 | 441  | 18166-EI | 447  | 18201-36 | 151  | 18225-28 | 151  | 18301-02 | 274  |
| 18028W36 | 148  | 18128-24 | 139  | 18162A55 | 439  | 18166-EJ | 448  | 18203-26 | 152  | 18225R28 | 151  | 18302-01 | 274  |
| 18029-25 | 148  | 18128-30 | 139  | 18162E55 | 439  | 18166-EL | 448  | 18205-10 | 151  | 18226-17 | 153  | 18302-02 | 275  |
| 18029W25 | 148  | 18132A54 | 442  | 18162U55 | 439  | 18166-EM | 447  | 18205-12 | 151  | 18226B17 | 153  | 18323-00 | 274  |
| 18029-30 | 147  | 18132E54 | 442  | 18162-56 | 438  | 18166-KE | 449  | 18206-09 | 151  | 18226G17 | 153  | 18324-00 | 274  |
| 18029W30 | 148  | 18132U54 | 442  | 18162A56 | 441  | 18166-KP | 449  | 18207-15 | 151  | 18226R17 | 153  | 18324-10 | 84   |
| 18029-36 | 147  | 18132A55 | 442  | 18162E56 | 441  | 18166-KU | 449  | 18209-06 | 151  | 18226W17 | 153  | 18324F10 | 524  |
| 18029W36 | 148  | 18132E55 | 442  | 18162U56 | 441  | 18168A24 | 440  | 18215-13 | 152  | 18226Y17 | 153  | 18325-01 | 200  |
| 18030-26 | 148  | 18132U55 | 442  | 18162A57 | 439  | 18168E24 | 440  | 18215-21 | 152  | 18230-13 | 139  | 18325-02 | 200  |
| 18030W26 | 148  | 18132-AE | 449  | 18162E57 | 439  | 18168U24 | 440  | 18217-12 | 147  | 18230-17 | 139  | 18325-03 | 200  |
| 18030-31 | 148  | 18132-AU | 449  | 18162U57 | 439  | 18168-GA | 449  | 18220-18 | 150  | 18231-13 | 139  | 18341-KE | 449  |
| 18030W31 | 148  | 18132-FB | 448  | 18162-AA | 447  | 18172-54 | 437  | 18220B18 | 150  | 18235-26 | 153  | 18341-KU | 449  |
| 18030-36 | 148  | 18132-KA | 448  | 18162-AF | 526  | 18172A54 | 441  | 18220R18 | 151  | 18235-30 | 153  | 18353-17 | 431  |
| 18030W36 | 148  | 18132-KE | 449  | 18162-AG | 526  | 18172E54 | 441  | 18220Y18 | 151  | 18235B30 | 153  | 18353-AA | 527  |
| 18099-15 | 158  | 18132-KP | 525  | 18162-KE | 449  | 18172U54 | 441  | 18220-20 | 150  | 18235G30 | 153  | 18353-BB | 527  |
| 18100-16 | 138  | 18132-KQ | 525  | 18162-KU | 449  | 18172A55 | 439  | 18220B20 | 150  | 18235R30 | 153  | 18353-CA | 527  |
| 18100-20 | 138  | 18132-KU | 449  | 18162-RA | 438  | 18172E55 | 439  | 18220R20 | 151  | 18235W30 | 153  | 18353-DB | 527  |
| 18100-24 | 138  | 18136A33 | 442  | 18162-RB | 438  | 18172U55 | 439  | 18220Y20 | 151  | 18235Y30 | 153  | 18353-VA | 527  |
| 18100-30 | 138  | 18136E33 | 442  | 18166-24 | 437  | 18172-56 | 437  | 18220-22 | 150  | 18236-30 | 153  | 18501-01 | 278  |
| 18100-36 | 138  | 18136U33 | 442  | 18166A24 | 440  | 18172A56 | 441  | 18220B22 | 150  | 18237-26 | 153  | 18501-02 | 278  |
| 18102-16 | 138  | 18136A34 | 442  | 18166E24 | 440  | 18172E56 | 441  | 18220R22 | 151  | 18251-01 | 153  | 18501-03 | 278  |
| 18102-20 | 138  | 18136E34 | 442  | 18166U24 | 440  | 18172U56 | 441  | 18220Y22 | 151  | 18251-02 | 153  | 18501-04 | 278  |
| 18102-26 | 138  | 18136U34 | 442  | 18166-30 | 437  | 18172A57 | 439  | 18220-26 | 150  | 18255-00 | 158  | 18501-05 | 278  |
| 18102-30 | 138  | 18136A40 | 442  | 18166A30 | 440  | 18172E57 | 439  | 18220B26 | 150  | 18261-00 | 154  | 18502-18 | 279  |
| 18103-18 | 138  | 18136E40 | 442  | 18166E30 | 440  | 18172U57 | 439  | 18220R26 | 151  | 18263-00 | 154  | 18503-12 | 279  |
| 18104-18 | 138  | 18136U40 | 442  | 18166I30 | 437  | 18172-AF | 526  | 18220Y26 | 151  | 18270-22 | 154  | 18504-15 | 279  |
| 18106-15 | 138  | 18136A41 | 442  | 18166-36 | 437  | 18172-AG | 526  | 18221-17 | 150  | 18271-00 | 155  | 18509-01 | 95   |
| 18106-20 | 138  | 18136E41 | 442  | 18166A36 | 440  | 18176-30 | 437  | 18221B17 | 150  | 18272-00 | 155  | 18509-02 | 95   |
| 18106-25 | 138  | 18136U41 | 442  | 18166E36 | 440  | 18176A30 | 440  | 18221G17 | 150  | 18273-00 | 155  | 18509-03 | 95   |
| 18106-30 | 138  | 18136-EA | 447  | 18166I36 | 437  | 18176E30 | 440  | 18221M17 | 150  | 18274-00 | 155  | 18510-07 | 95   |

| Cod.     | pag. | Cod.     | pag. | Cod.     | pag. | Cod.     | pag. | Cod.     | pag. | Cod.     | pag. | Cod.     | pag. |
|----------|------|----------|------|----------|------|----------|------|----------|------|----------|------|----------|------|
| 18510F07 | 524  | 18878-00 | 452  | 18897M00 | 454  | 41200-48 | 344  | 41220-07 | 420  | 41327-02 | 337  | 41442-23 | 426  |
| 18511-15 | 96   | 18878M00 | 452  | 18897N00 | 454  | 41200-49 | 344  | 41311-00 | 363  | 41327-03 | 337  | 41443-AE | 527  |
| 18511F15 | 524  | 18878N00 | 452  | 18897R00 | 454  | 41200-50 | 344  | 41311-AA | 527  | 41327-04 | 337  | 41445-01 | 430  |
| 18512-15 | 96   | 18878R00 | 452  | 19701-00 | 129  | 41200-51 | 344  | 41311-AB | 527  | 41327-05 | 337  | 41445-02 | 430  |
| 18513-14 | 96   | 18879-00 | 453  | 19702-00 | 129  | 41200-52 | 344  | 41312-00 | 363  | 41327-06 | 338  | 41445-22 | 402  |
| 18513F14 | 524  | 18879M00 | 453  | 19705-00 | 128  | 41200-53 | 344  | 41313-00 | 364  | 41327-07 | 338  | 41445-26 | 402  |
| 18514-17 | 96   | 18879N00 | 453  | 19706-00 | 128  | 41200-54 | 344  | 41314-00 | 364  | 41327-08 | 338  | 41445-30 | 402  |
| 18514-18 | 96   | 18879R00 | 453  | 19709-00 | 128  | 41200-55 | 344  | 41315-02 | 364  | 41327-09 | 338  | 41446-18 | 402  |
| 18515-16 | 96   | 18880-00 | 453  | 19810-00 | 126  | 41200-56 | 344  | 41315-04 | 364  | 41327-10 | 338  | 41446-23 | 402  |
| 18516-24 | 96   | 18880M00 | 453  | 19810-AA | 527  | 41200-57 | 344  | 41317-20 | 364  | 41380-01 | 134  | 41447-02 | 421  |
| 18517-24 | 96   | 18880N00 | 453  | 19810-AB | 527  | 41200-58 | 344  | 41318-00 | 363  | 41380-02 | 134  | 41447-05 | 421  |
| 18518-22 | 96   | 18880R00 | 453  | 19901-35 | 455  | 41200-59 | 344  | 41320-25 | 338  | 41390-00 | 372  | 41447-38 | 288  |
| 18518-26 | 96   | 18882-00 | 453  | 19901-40 | 455  | 41200-60 | 344  | 41320-30 | 338  | 41394-02 | 420  | 41447-39 | 528  |
| 18518-30 | 96   | 18882M00 | 453  | 19901-47 | 455  | 41200-61 | 344  | 41320-35 | 338  | 41400-AA | 424  | 41448-06 | 425  |
| 18519-15 | 96   | 18882N00 | 453  | 19902-38 | 455  | 41200-62 | 344  | 41321-40 | 338  | 41400-AB | 527  | 41448-10 | 425  |
| 18519-22 | 96   | 18882R00 | 453  | 32931-02 | 369  | 41200-63 | 344  | 41321-44 | 338  | 41402-AA | 527  | 41448-25 | 425  |
| 18519-26 | 96   | 18884-00 | 453  | 32931-03 | 370  | 41200-64 | 344  | 41322-19 | 338  | 41403-01 | 427  | 41448-40 | 425  |
| 18519-30 | 96   | 18884M00 | 453  | 32931-05 | 370  | 41205-01 | 334  | 41322-25 | 338  | 41403-02 | 428  | 41449-27 | 427  |
| 18519-35 | 96   | 18884N00 | 453  | 32935-03 | 370  | 41205-02 | 334  | 41322-31 | 338  | 41403-03 | 428  | 41449-32 | 427  |
| 18520-04 | 96   | 18884R00 | 453  | 32935-05 | 370  | 41205-03 | 334  | 41323-01 | 335  | 41403-04 | 428  | 41450-AA | 300  |
| 18520-06 | 96   | 18886-00 | 451  | 32935-10 | 370  | 41205-04 | 334  | 41323-02 | 335  | 41405-AA | 424  | 41451-05 | 300  |
| 18520-08 | 96   | 18886M00 | 451  | 32935-22 | 370  | 41205-05 | 334  | 41323-03 | 335  | 41405-AB | 527  | 41451-10 | 300  |
| 18520-10 | 96   | 18886N00 | 451  | 32936-03 | 370  | 41205-06 | 334  | 41323-04 | 335  | 41412-11 | 422  | 41452N10 | 284  |
| 18520-12 | 96   | 18886R00 | 451  | 32936-05 | 370  | 41205-07 | 333  | 41323-06 | 335  | 41414-30 | 288  | 41452N16 | 284  |
| 18520-15 | 279  | 18887-00 | 451  | 41200-01 | 343  | 41205-08 | 333  | 41323-07 | 335  | 41414-31 | 289  | 41453-11 | 317  |
| 18874-11 | 451  | 18887M00 | 451  | 41200-02 | 343  | 41205-09 | 333  | 41323-08 | 335  | 41415-10 | 422  | 41453-AA | 318  |
| 18874M11 | 451  | 18887N00 | 451  | 41200-03 | 343  | 41205-10 | 334  | 41323-11 | 335  | 41415-11 | 418  | 41454-01 | 317  |
| 18874N11 | 451  | 18887R00 | 451  | 41200-04 | 343  | 41206-01 | 338  | 41323-12 | 335  | 41418-11 | 418  | 41454-99 | 318  |
| 18874R11 | 451  | 18888-00 | 455  | 41200-05 | 343  | 41206-02 | 338  | 41323-13 | 335  | 41418-12 | 418  | 41455T55 | 300  |
| 18874-22 | 451  | 18888M00 | 455  | 41200-06 | 343  | 41206-03 | 287  | 41323-14 | 335  | 41419-12 | 418  | 41455-BC | 300  |
| 18874M22 | 451  | 18888N00 | 455  | 41200-07 | 343  | 41206-04 | 334  | 41323-16 | 335  | 41425-AA | 424  | 41455-CA | 301  |
| 18874N22 | 451  | 18888R00 | 455  | 41200-08 | 343  | 41206-05 | 430  | 41323-17 | 335  | 41427-40 | 424  | 41455-CB | 301  |
| 18874R22 | 451  | 18889-00 | 454  | 41200-09 | 343  | 41207-02 | 339  | 41323-18 | 335  | 41428-03 | 422  | 41456-02 | 317  |
| 18875-00 | 452  | 18889M00 | 454  | 41200-10 | 343  | 41207-03 | 339  | 41323-21 | 335  | 41429-04 | 421  | 41457-00 | 318  |
| 18875M00 | 452  | 18889N00 | 454  | 41200-11 | 343  | 41210-01 | 40   | 41323-22 | 335  | 41430-11 | 411  | 41458-02 | 300  |
| 18875N00 | 452  | 18889R00 | 454  | 41200-13 | 343  | 41210-03 | 40   | 41323-23 | 335  | 41431-08 | 291  | 41458-05 | 300  |
| 18875R00 | 452  | 18891-00 | 454  | 41200-14 | 343  | 41210-05 | 40   | 41323-24 | 335  | 41431-12 | 291  | 41458-10 | 300  |
| 18876-00 | 451  | 18891M00 | 454  | 41200-15 | 343  | 41210-07 | 40   | 41323-26 | 335  | 41436-11 | 411  | 41458-11 | 301  |
| 18876M00 | 451  | 18891N00 | 454  | 41200-16 | 343  | 41210-08 | 40   | 41323-27 | 335  | 41436-12 | 411  | 41458-21 | 301  |
| 18876N00 | 451  | 18891R00 | 454  | 41200-17 | 343  | 41210-10 | 40   | 41323-28 | 335  | 41437-11 | 411  | 41458-23 | 300  |
| 18876R00 | 451  | 18893-00 | 455  | 41200-18 | 344  | 41210-12 | 40   | 41323-99 | 336  | 41437-12 | 411  | 41458-24 | 301  |
| 18876-01 | 452  | 18893M00 | 455  | 41200-32 | 344  | 41210-13 | 40   | 41323-AA | 527  | 41438-50 | 412  | 41458-25 | 301  |
| 18876M01 | 452  | 18893N00 | 455  | 41200-33 | 344  | 41210-14 | 40   | 41325-20 | 338  | 41438-60 | 412  | 41458-50 | 301  |
| 18876N01 | 452  | 18893R00 | 455  | 41200-34 | 344  | 41220-01 | 420  | 41325-30 | 338  | 41438-70 | 412  | 41458-51 | 301  |
| 18876R01 | 452  | 18895-00 | 454  | 41200-36 | 344  | 41220-02 | 419  | 41325-40 | 338  | 41439-32 | 411  | 41459-10 | 300  |
| 18877-00 | 452  | 18895M00 | 454  | 41200-40 | 344  | 41220-03 | 419  | 41326-30 | 339  | 41439-38 | 411  | 41460-05 | 300  |
| 18877M00 | 452  | 18895N00 | 454  | 41200-41 | 344  | 41220-04 | 420  | 41326-36 | 339  | 41439-48 | 411  | 41460-10 | 300  |
| 18877N00 | 452  | 18895R00 | 454  | 41200-46 | 344  | 41220-05 | 420  | 41326-42 | 339  | 41442-03 | 425  | 41461-07 | 312  |
| 18877R00 | 452  | 18897-00 | 454  | 41200-47 | 344  | 41220-06 | 419  | 41327-01 | 337  | 41442-14 | 426  | 41461B07 | 312  |

**NUMERICAL INDEX INDICE NUMERICO NUMERISCH INDEX INDEX NUMERIQUE INDICE NUMERICO**

| Cod.     | pag. | Cod.     | pag. | Cod.     | pag. | Cod.     | pag. | Cod.     | pag. | Cod.     | pag. | Cod.     | pag. |
|----------|------|----------|------|----------|------|----------|------|----------|------|----------|------|----------|------|
| 41461C07 | 312  | 41472-23 | 295  | 41479-15 | 313  | 41491G05 | 309  | 41512-50 | 320  | 41526-G2 | 106  | 41585-37 | 348  |
| 41461G07 | 312  | 41472-24 | 294  | 41479-AA | 313  | 41491C06 | 309  | 41513-13 | 320  | 41526-G3 | 106  | 41585-45 | 349  |
| 41463A00 | 305  | 41472-25 | 286  | 41480-03 | 312  | 41491G06 | 309  | 41513B20 | 320  | 41526-R1 | 106  | 41585-51 | 349  |
| 41463C00 | 305  | 41472-26 | 294  | 41480-05 | 312  | 41492-00 | 331  | 41513C20 | 320  | 41526-R2 | 106  | 41585-52 | 349  |
| 41463-01 | 303  | 41472-27 | 294  | 41480B05 | 312  | 41492B00 | 331  | 41513G20 | 320  | 41526-R3 | 106  | 41585-53 | 349  |
| 41463-02 | 304  | 41472-28 | 294  | 41480C05 | 312  | 41492C00 | 331  | 41514-05 | 313  | 41527-10 | 332  | 41585-54 | 349  |
| 41463A05 | 304  | 41472-29 | 294  | 41480G05 | 312  | 41492G00 | 331  | 41514-10 | 313  | 41527G10 | 333  | 41586-22 | 349  |
| 41463B05 | 304  | 41472-32 | 287  | 41480-07 | 312  | 41493B00 | 303  | 41515-03 | 318  | 41527-11 | 332  | 41586-28 | 349  |
| 41463G05 | 304  | 41472-33 | 298  | 41481-02 | 312  | 41493C00 | 303  | 41515-05 | 319  | 41527G11 | 333  | 41586-33 | 349  |
| 41463M05 | 304  | 41472-34 | 298  | 41481-03 | 312  | 41493G00 | 303  | 41515-07 | 319  | 41527-12 | 332  | 41586-38 | 349  |
| 41463A30 | 304  | 41472-35 | 298  | 41483-04 | 312  | 41494B00 | 303  | 41515-08 | 318  | 41527G12 | 333  | 41587-25 | 349  |
| 41463C30 | 304  | 41472-36 | 298  | 41483-06 | 312  | 41494C00 | 303  | 41515-09 | 319  | 41527-13 | 332  | 41587-32 | 349  |
| 41463A50 | 304  | 41472-37 | 299  | 41484-05 | 311  | 41494G00 | 303  | 41515-10 | 318  | 41527G13 | 333  | 41589-08 | 352  |
| 41463C50 | 304  | 41472-38 | 299  | 41484B05 | 311  | 41495-08 | 308  | 41515-20 | 319  | 41528-21 | 105  | 41589C08 | 353  |
| 41464-09 | 312  | 41472-39 | 299  | 41484C05 | 311  | 41495-10 | 308  | 41515-21 | 319  | 41528-22 | 105  | 41589-14 | 352  |
| 41464B09 | 312  | 41472-40 | 299  | 41484G05 | 311  | 41496-40 | 369  | 41515-22 | 319  | 41529-05 | 356  | 41589-16 | 352  |
| 41464C09 | 312  | 41472-41 | 299  | 41486-00 | 291  | 41497-05 | 305  | 41518-00 | 366  | 41530-05 | 356  | 41589C16 | 353  |
| 41464G09 | 312  | 41472-42 | 299  | 41486-01 | 291  | 41497B05 | 305  | 41518-01 | 366  | 41530-07 | 356  | 41589-20 | 353  |
| 41465-10 | 317  | 41472-43 | 292  | 41486-08 | 291  | 41497C05 | 305  | 41518-02 | 366  | 41530-11 | 356  | 41589-22 | 352  |
| 41467B08 | 312  | 41472-44 | 292  | 41486-12 | 291  | 41497G05 | 305  | 41518B12 | 320  | 41538-30 | 288  | 41589-25 | 353  |
| 41467C08 | 312  | 41472-45 | 293  | 41486-15 | 291  | 41498B00 | 303  | 41518C12 | 320  | 41541-44 | 408  | 41589-37 | 353  |
| 41467G08 | 312  | 41472-46 | 292  | 41487-12 | 291  | 41498C00 | 303  | 41518G12 | 320  | 41558-00 | 367  | 41589-50 | 353  |
| 41468-20 | 291  | 41472-47 | 299  | 41487-15 | 291  | 41498G00 | 303  | 41520-08 | 106  | 41559-04 | 367  | 41589-58 | 353  |
| 41468-24 | 291  | 41472-48 | 299  | 41487-17 | 291  | 41499-08 | 369  | 41520-12 | 106  | 41560-28 | 362  | 41589-99 | 353  |
| 41469-20 | 291  | 41472-50 | 299  | 41488-45 | 292  | 41500-00 | 330  | 41520-16 | 106  | 41561-09 | 356  | 41589-AA | 353  |
| 41469-24 | 291  | 41473-31 | 292  | 41488-47 | 292  | 41500-AA | 330  | 41520-24 | 106  | 41562-18 | 366  | 41589-AB | 353  |
| 41470A00 | 306  | 41473-39 | 292  | 41488-50 | 292  | 41501-20 | 367  | 41522-14 | 332  | 41563-07 | 356  | 41589-AC | 353  |
| 41470C00 | 306  | 41473-44 | 292  | 41488-53 | 292  | 41502-20 | 367  | 41523-08 | 332  | 41563-AA | 528  | 41589-BB | 353  |
| 41470A03 | 306  | 41473-50 | 292  | 41489-20 | 291  | 41503-00 | 318  | 41523G08 | 333  | 41564-07 | 356  | 41589-CC | 353  |
| 41470C03 | 306  | 41473-56 | 292  | 41490-00 | 307  | 41503-21 | 318  | 41523-09 | 332  | 41564-AA | 528  | 41591-32 | 367  |
| 41471-00 | 291  | 41473-62 | 292  | 41490B00 | 307  | 41503-22 | 318  | 41523G09 | 333  | 41569-33 | 364  | 41591-36 | 367  |
| 41471-12 | 291  | 41473-66 | 292  | 41490C00 | 307  | 41504-09 | 368  | 41524-04 | 332  | 41570-10 | 111  | 41591-40 | 367  |
| 41471-15 | 291  | 41474-00 | 292  | 41490G00 | 307  | 41504-10 | 368  | 41524-09 | 332  | 41570B10 | 310  | 41591-45 | 367  |
| 41471-17 | 291  | 41474-02 | 292  | 41490-01 | 307  | 41504-11 | 368  | 41524-10 | 333  | 41570C10 | 310  | 41591-90 | 366  |
| 41472-01 | 293  | 41475-00 | 291  | 41490B01 | 307  | 41504-12 | 368  | 41524C10 | 333  | 41570G10 | 310  | 41592-36 | 367  |
| 41472-04 | 293  | 41475-01 | 291  | 41490C01 | 307  | 41504-19 | 368  | 41524-11 | 333  | 41582-00 | 163  | 41592-45 | 367  |
| 41472-07 | 293  | 41475-03 | 291  | 41490G01 | 307  | 41505-17 | 368  | 41524C11 | 333  | 41583-00 | 164  | 41593-20 | 366  |
| 41472-08 | 293  | 41475-04 | 291  | 41490-AA | 307  | 41505-19 | 368  | 41524-12 | 333  | 41585-00 | 349  | 41594-12 | 366  |
| 41472-12 | 287  | 41475-05 | 291  | 41491C00 | 308  | 41505-20 | 367  | 41524C12 | 333  | 41585-01 | 349  | 41594-18 | 366  |
| 41472-13 | 287  | 41475-20 | 291  | 41491G00 | 308  | 41507-01 | 368  | 41525-00 | 285  | 41585-02 | 349  | 41595-20 | 310  |
| 41472-14 | 295  | 41476-50 | 292  | 41491C01 | 308  | 41508-10 | 368  | 41525-01 | 285  | 41585-03 | 349  | 41595B44 | 113  |
| 41472-15 | 295  | 41477-50 | 313  | 41491G01 | 308  | 41508C12 | 368  | 41526-01 | 106  | 41585-10 | 349  | 41595B45 | 113  |
| 41472-16 | 294  | 41478-35 | 313  | 41491C02 | 308  | 41510-05 | 320  | 41526-02 | 106  | 41585-11 | 348  | 41597-04 | 356  |
| 41472-17 | 294  | 41478-50 | 313  | 41491G02 | 308  | 41510-08 | 369  | 41526-05 | 106  | 41585-12 | 348  | 41598-00 | 356  |
| 41472-18 | 294  | 41479-05 | 313  | 41491C03 | 309  | 41511-00 | 369  | 41526-06 | 106  | 41585-13 | 348  | 41599-08 | 356  |
| 41472-19 | 295  | 41479-11 | 313  | 41491G03 | 309  | 41511-20 | 369  | 41526-B1 | 106  | 41585-23 | 348  | 41600-00 | 310  |
| 41472-20 | 294  | 41479-12 | 313  | 41491C04 | 309  | 41511-30 | 369  | 41526-B2 | 106  | 41585-24 | 348  | 41600C00 | 310  |
| 41472-21 | 294  | 41479-13 | 313  | 41491G04 | 309  | 41512-15 | 320  | 41526-B3 | 106  | 41585-25 | 348  | 41600G00 | 310  |
| 41472-22 | 294  | 41479-14 | 313  | 41491C05 | 309  | 41512-30 | 320  | 41526-G1 | 106  | 41585-30 | 348  | 41601-17 | 287  |

| Cod.     | pag. | Cod.     | pag. | Cod.     | pag. | Cod.     | pag. | Cod.     | pag. | Cod.     | pag. | Cod.     | pag. |
|----------|------|----------|------|----------|------|----------|------|----------|------|----------|------|----------|------|
| 41602-00 | 287  | 41615-05 | 357  | 41659-06 | 210  | 41699-03 | 330  | 41735-29 | 271  | 41752-12 | 282  | 41766-16 | 272  |
| 41603-00 | 310  | 41617-05 | 287  | 41659-07 | 210  | 41699-04 | 330  | 41736-32 | 272  | 41752-24 | 282  | 41766-27 | 272  |
| 41603B00 | 310  | 41617-15 | 287  | 41659-08 | 210  | 41699-06 | 325  | 41737-17 | 272  | 41753-30 | 195  | 41767-20 | 272  |
| 41603C00 | 310  | 41618-14 | 287  | 41660-10 | 209  | 41699-10 | 329  | 41737-20 | 272  | 41753D30 | 205  | 41767G20 | 273  |
| 41603G00 | 310  | 41620-04 | 356  | 41660-15 | 209  | 41699-11 | 329  | 41737G20 | 274  | 41753-32 | 195  | 41767-AA | 528  |
| 41603-07 | 310  | 41628-15 | 369  | 41670-06 | 100  | 41699-12 | 330  | 41737-23 | 272  | 41753D32 | 205  | 41768-21 | 272  |
| 41603B07 | 310  | 41629-17 | 357  | 41670-09 | 100  | 41699-13 | 330  | 41737G23 | 274  | 41753-53 | 195  | 41768-22 | 272  |
| 41603C07 | 310  | 41629-20 | 357  | 41670-AA | 100  | 41699-18 | 330  | 41738-17 | 272  | 41753D53 | 205  | 41769-00 | 273  |
| 41603G07 | 310  | 41629-25 | 357  | 41670-AB | 100  | 41699B18 | 330  | 41738-20 | 272  | 41753-60 | 195  | 41769G00 | 273  |
| 41604-00 | 311  | 41635-02 | 360  | 41671-11 | 100  | 41699C18 | 330  | 41738-23 | 272  | 41753D60 | 205  | 41769-01 | 273  |
| 41604B00 | 311  | 41636-25 | 361  | 41672-00 | 100  | 41699G18 | 330  | 41739-20 | 272  | 41755-11 | 282  | 41769-02 | 273  |
| 41604C00 | 311  | 41638-01 | 361  | 41673-00 | 100  | 41699-20 | 329  | 41740-00 | 273  | 41756-30 | 194  | 41769-36 | 273  |
| 41604G00 | 311  | 41638-02 | 361  | 41674-00 | 100  | 41703-38 | 33   | 41743-32 | 195  | 41756-32 | 194  | 41769-50 | 273  |
| 41604-01 | 311  | 41638-04 | 361  | 41675-00 | 100  | 41704G33 | 273  | 41743D32 | 205  | 41756-53 | 194  | 41770-15 | 280  |
| 41604B01 | 311  | 41638-12 | 361  | 41676-00 | 100  | 41704G36 | 273  | 41743-53 | 195  | 41756-60 | 194  | 41771-96 | 280  |
| 41604C01 | 311  | 41638-13 | 361  | 41677-00 | 100  | 41707-32 | 33   | 41743D53 | 205  | 41758-53 | 254  | 41773-00 | 103  |
| 41604G01 | 311  | 41638-91 | 528  | 41678-00 | 100  | 41707-36 | 33   | 41743-60 | 195  | 41758-60 | 254  | 41774-33 | 275  |
| 41605-00 | 309  | 41638-92 | 528  | 41678-14 | 369  | 41707-40 | 33   | 41743D60 | 205  | 41758-65 | 254  | 41775-34 | 275  |
| 41605-01 | 309  | 41638-93 | 528  | 41679-23 | 363  | 41707-45 | 33   | 41744-32 | 194  | 41758-85 | 254  | 41780-05 | 268  |
| 41605-03 | 309  | 41638-94 | 528  | 41680-03 | 321  | 41707-50 | 33   | 41744-53 | 194  | 41759-01 | 252  | 41780-07 | 268  |
| 41605B03 | 309  | 41638-95 | 528  | 41680-06 | 321  | 41708-32 | 33   | 41744-60 | 194  | 41759-02 | 253  | 41780-09 | 268  |
| 41605C03 | 309  | 41639-11 | 362  | 41680-12 | 321  | 41708-36 | 33   | 41745-30 | 281  | 41759-03 | 253  | 41781-05 | 271  |
| 41605G03 | 309  | 41639-17 | 362  | 41681-01 | 322  | 41708-40 | 33   | 41745-35 | 281  | 41759-05 | 253  | 41781-10 | 271  |
| 41605-25 | 310  | 41639-30 | 362  | 41681-02 | 322  | 41708-45 | 33   | 41745-40 | 281  | 41759-09 | 253  | 41781-15 | 271  |
| 41605B27 | 309  | 41639-31 | 362  | 41681-03 | 322  | 41708-50 | 33   | 41745-50 | 281  | 41760-02 | 253  | 41782-04 | 324  |
| 41605G27 | 309  | 41639-32 | 362  | 41681-04 | 322  | 41717-60 | 33   | 41745-60 | 281  | 41760-05 | 253  | 41782-05 | 324  |
| 41606-00 | 317  | 41639-40 | 362  | 41681-06 | 321  | 41717-80 | 33   | 41745-65 | 281  | 41760-06 | 253  | 41782-06 | 324  |
| 41606-01 | 317  | 41639-41 | 362  | 41681-10 | 321  | 41719-32 | 33   | 41746-60 | 194  | 41760-08 | 253  | 41800-05 | 431  |
| 41606-02 | 317  | 41639-42 | 362  | 41681-11 | 321  | 41719-36 | 33   | 41747-60 | 195  | 41760-09 | 253  | 41800-10 | 431  |
| 41606-22 | 317  | 41645-00 | 285  | 41681-12 | 321  | 41719-40 | 33   | 41748-20 | 195  | 41760-20 | 252  | 41801-05 | 431  |
| 41607-00 | 285  | 41646-06 | 354  | 41681-99 | 322  | 41720-18 | 29   | 41748-30 | 195  | 41760-21 | 252  | 41806-00 | 430  |
| 41608-00 | 328  | 41646-10 | 354  | 41683-26 | 104  | 41720-20 | 29   | 41748-35 | 195  | 41760-22 | 252  | 41806-03 | 430  |
| 41608-03 | 328  | 41646-15 | 354  | 41686-12 | 366  | 41720-24 | 29   | 41748-40 | 195  | 41760-26 | 252  | 41807-12 | 431  |
| 41608-04 | 325  | 41646-20 | 354  | 41687-06 | 366  | 41720-28 | 29   | 41748-50 | 195  | 41760-27 | 252  | 41808-04 | 431  |
| 41608-08 | 328  | 41650-06 | 354  | 41687-12 | 366  | 41720-30 | 29   | 41750-20 | 195  | 41761-02 | 273  | 41809-09 | 448  |
| 41608-20 | 328  | 41650-10 | 354  | 41690A11 | 443  | 41720-32 | 29   | 41750-30 | 195  | 41762-07 | 279  | 41810-04 | 430  |
| 41609-36 | 311  | 41650-13 | 354  | 41690E11 | 443  | 41727-28 | 280  | 41750-40 | 195  | 41762-09 | 279  | 41810-09 | 430  |
| 41609B36 | 311  | 41651-20 | 412  | 41690U11 | 443  | 41727-30 | 280  | 41750-41 | 195  | 41762-13 | 279  | 41820-03 | 366  |
| 41609C36 | 311  | 41651-25 | 412  | 41691A11 | 443  | 41727-33 | 280  | 41750-50 | 195  | 41763-00 | 279  | 41860-36 | 474  |
| 41609G36 | 311  | 41651-30 | 412  | 41691E11 | 443  | 41727-36 | 280  | 41751-30 | 194  | 41763-30 | 468  | 41860-43 | 474  |
| 41609-75 | 311  | 41651-35 | 412  | 41691U11 | 443  | 41727-40 | 280  | 41751F30 | 524  | 41764-28 | 272  | 41860-47 | 474  |
| 41611-20 | 317  | 41651-40 | 412  | 41695-10 | 449  | 41727-45 | 280  | 41751-35 | 194  | 41764-33 | 272  | 41861-44 | 475  |
| 41614-22 | 286  | 41651-45 | 412  | 41695-15 | 449  | 41727-50 | 280  | 41751-40 | 194  | 41764-40 | 272  | 41862B11 | 475  |
| 41614-33 | 286  | 41651-50 | 412  | 41695-50 | 449  | 41727-55 | 280  | 41751F40 | 524  | 41765-32 | 271  | 41862C11 | 475  |
| 41614-34 | 286  | 41651-55 | 412  | 41695-90 | 449  | 41727-60 | 280  | 41751-50 | 194  | 41765-37 | 271  | 41862G11 | 475  |
| 41614-35 | 286  | 41651-60 | 412  | 41697-00 | 102  | 41729-30 | 212  | 41751-60 | 194  | 41765-41 | 271  | 41862B53 | 475  |
| 41614-36 | 286  | 41651-65 | 412  | 41698-22 | 102  | 41729-34 | 212  | 41751F60 | 524  | 41765-45 | 271  | 41862C53 | 475  |
| 41615-01 | 357  | 41654-80 | 412  | 41698-30 | 102  | 41734-60 | 280  | 41751-65 | 194  | 41765-50 | 271  | 41862G53 | 475  |
| 41615-03 | 357  | 41654-99 | 412  | 41698-40 | 102  | 41735-20 | 272  | 41752-08 | 282  | 41766-14 | 272  | 41870-01 | 406  |

**NUMERICAL INDEX INDICE NUMERICO NUMERISCH INDEX INDEX NUMERIQUE INDICE NUMERICO**

| Cod.     | pag. | Cod.     | pag. | Cod.     | pag. | Cod.     | pag. | Cod.     | pag. | Cod.     | pag. | Cod.     | pag. |
|----------|------|----------|------|----------|------|----------|------|----------|------|----------|------|----------|------|
| 41870-02 | 406  | 41908-00 | 428  | 41961-10 | 109  | 42452-53 | 418  | 42501-15 | 162  | 42521-16 | 165  | 42537-80 | 165  |
| 41870-03 | 406  | 41908-01 | 428  | 41961-12 | 109  | 42453-23 | 424  | 42501-20 | 162  | 42521-24 | 165  | 42538-00 | 165  |
| 41870-04 | 406  | 41909-08 | 430  | 41961-15 | 109  | 42460-00 | 423  | 42502-11 | 162  | 42522-00 | 165  | 42538-01 | 165  |
| 41875-40 | 410  | 41910-AL | 528  | 41962-10 | 109  | 42460-06 | 423  | 42503-10 | 162  | 42522-01 | 165  | 42538-02 | 165  |
| 41875-61 | 410  | 41911-02 | 428  | 41962-12 | 109  | 42460-26 | 425  | 42504-09 | 103  | 42522-02 | 165  | 42538-03 | 165  |
| 41876-30 | 410  | 41911-03 | 429  | 41962-15 | 109  | 42460-27 | 425  | 42505-21 | 162  | 42522-03 | 165  | 42538-04 | 165  |
| 41876-38 | 410  | 41911-04 | 429  | 41964-45 | 25   | 42460-43 | 430  | 42505-24 | 162  | 42522-04 | 165  | 42538-05 | 165  |
| 41876-45 | 410  | 41911-AA | 529  | 41964-60 | 25   | 42460-45 | 431  | 42505-27 | 162  | 42522-05 | 165  | 42538-07 | 165  |
| 41876-58 | 410  | 41911-AE | 529  | 41980-99 | 103  | 42460-53 | 429  | 42505-50 | 162  | 42522-07 | 165  | 42538-09 | 165  |
| 41877-45 | 409  | 41912-03 | 427  | 42400-19 | 432  | 42460-63 | 423  | 42506-08 | 162  | 42522-09 | 165  | 42538F09 | 524  |
| 41877-61 | 409  | 41912-04 | 427  | 42400-25 | 432  | 42460-64 | 424  | 42506-10 | 162  | 42522F09 | 524  | 42539-00 | 165  |
| 41877-81 | 409  | 41913-03 | 427  | 42400-30 | 432  | 42460-74 | 432  | 42506-12 | 162  | 42523-00 | 160  | 42539-01 | 165  |
| 41877-99 | 409  | 41913-04 | 427  | 42401-10 | 354  | 42460-76 | 432  | 42506-14 | 162  | 42524-06 | 162  | 42539-02 | 165  |
| 41878-45 | 409  | 41914-03 | 25   | 42401-15 | 354  | 42461-11 | 418  | 42506-16 | 162  | 42524-08 | 162  | 42539-03 | 165  |
| 41878-61 | 409  | 41916-10 | 110  | 42401-20 | 354  | 42461-35 | 418  | 42506-18 | 162  | 42524-10 | 162  | 42539-04 | 165  |
| 41878-81 | 409  | 41916-15 | 110  | 42401-AA | 529  | 42462-11 | 415  | 42507-12 | 161  | 42524-12 | 162  | 42539-05 | 165  |
| 41878-99 | 409  | 41916-20 | 110  | 42403-01 | 354  | 42462-12 | 415  | 42508-00 | 163  | 42524-14 | 162  | 42539-07 | 165  |
| 41879-30 | 410  | 41919-03 | 405  | 42403B01 | 354  | 42462-13 | 415  | 42508-01 | 163  | 42524-16 | 162  | 42539-09 | 165  |
| 41879-40 | 410  | 41920-03 | 432  | 42405-10 | 354  | 42462-14 | 415  | 42509-25 | 103  | 42524-18 | 162  | 42539F09 | 524  |
| 41879-50 | 410  | 41920-05 | 432  | 42405-20 | 354  | 42462-16 | 415  | 42509-50 | 103  | 42524-20 | 162  | 42540-40 | 166  |
| 41879-61 | 410  | 41922-16 | 110  | 42405-AA | 529  | 42462-23 | 415  | 42509-60 | 104  | 42524-22 | 162  | 42540-50 | 166  |
| 41880-38 | 410  | 41922-22 | 110  | 42406-35 | 432  | 42463A00 | 429  | 42509-99 | 104  | 42524-30 | 162  | 42540-80 | 166  |
| 41880-61 | 410  | 41925-14 | 111  | 42406-40 | 432  | 42463B00 | 429  | 42510-00 | 162  | 42525-27 | 162  | 42541-06 | 166  |
| 41881-30 | 410  | 41925-16 | 111  | 42407-03 | 354  | 42463A02 | 413  | 42511-20 | 161  | 42526-12 | 162  | 42542-00 | 167  |
| 41881-40 | 410  | 41925-18 | 111  | 42407-06 | 354  | 42463B02 | 413  | 42511-25 | 161  | 42526-14 | 162  | 42543-00 | 166  |
| 41882-15 | 410  | 41925-20 | 111  | 42413-24 | 365  | 42463A04 | 413  | 42511-30 | 161  | 42529-06 | 161  | 42543-01 | 166  |
| 41882-20 | 410  | 41925-22 | 111  | 42414-05 | 365  | 42463B04 | 413  | 42511-35 | 161  | 42530-26 | 163  | 42543-02 | 166  |
| 41882-25 | 410  | 41925-24 | 111  | 42414-10 | 365  | 42463A05 | 413  | 42511-40 | 161  | 42530-32 | 163  | 42543-03 | 166  |
| 41882-30 | 410  | 41925-26 | 111  | 42414-15 | 365  | 42463B05 | 414  | 42511-56 | 161  | 42530-41 | 163  | 42543-04 | 166  |
| 41885-30 | 409  | 41929-00 | 101  | 42414-20 | 365  | 42463A08 | 413  | 42511-60 | 161  | 42530-50 | 163  | 42543-05 | 166  |
| 41885-40 | 409  | 41929-02 | 101  | 42417-22 | 365  | 42463B08 | 414  | 42511-70 | 161  | 42531-26 | 163  | 42544-00 | 166  |
| 41885-45 | 409  | 41930-39 | 25   | 42420-06 | 363  | 42463-11 | 415  | 42512-35 | 104  | 42531-32 | 163  | 42544-01 | 166  |
| 41885-50 | 409  | 41931-08 | 112  | 42420-08 | 363  | 42463-12 | 415  | 42512-90 | 475  | 42531-41 | 163  | 42544-02 | 166  |
| 41885-60 | 409  | 41931-14 | 112  | 42440-30 | 410  | 42463-13 | 415  | 42512-91 | 475  | 42531-50 | 163  | 42544-03 | 166  |
| 41900-04 | 432  | 41931-16 | 112  | 42441-25 | 410  | 42463-14 | 415  | 42512-92 | 475  | 42532-29 | 163  | 42544-04 | 166  |
| 41900-10 | 432  | 41931-18 | 112  | 42442-24 | 410  | 42463-16 | 415  | 42512-93 | 475  | 42532-58 | 163  | 42544-05 | 166  |
| 41901-08 | 431  | 41932-05 | 112  | 42443-06 | 370  | 42463-23 | 415  | 42513-30 | 104  | 42533-23 | 204  | 42546-00 | 165  |
| 41901-16 | 431  | 41933-18 | 112  | 42443-08 | 370  | 42470-00 | 423  | 42513-45 | 104  | 42533-26 | 204  | 42546-01 | 165  |
| 41903A10 | 443  | 41940-06 | 422  | 42445-03 | 371  | 42470-06 | 423  | 42514-20 | 161  | 42533-31 | 204  | 42546-02 | 165  |
| 41903E10 | 443  | 41940B06 | 422  | 42445-04 | 371  | 42470-07 | 423  | 42515-18 | 161  | 42533-36 | 204  | 42546-03 | 165  |
| 41903U10 | 443  | 41941-43 | 423  | 42445-05 | 371  | 42470-26 | 425  | 42515-20 | 161  | 42533-40 | 204  | 42546-04 | 165  |
| 41904-10 | 432  | 41941-44 | 422  | 42446-04 | 371  | 42470-27 | 425  | 42516-18 | 161  | 42534-26 | 163  | 42546-05 | 165  |
| 41905-03 | 421  | 41944-06 | 421  | 42450-00 | 423  | 42470-43 | 430  | 42516-20 | 161  | 42534-32 | 163  | 42555-11 | 268  |
| 41905-38 | 421  | 41944B06 | 421  | 42450-AD | 423  | 42470-45 | 431  | 42517-06 | 161  | 42534-41 | 163  | 42556-00 | 123  |
| 41906-60 | 422  | 41945-38 | 422  | 42451-11 | 423  | 42470-53 | 429  | 42518-01 | 165  | 42535-24 | 166  | 42558-00 | 124  |
| 41907-02 | 432  | 41960-08 | 109  | 42451-12 | 423  | 42470-63 | 423  | 42518-50 | 166  | 42535-32 | 166  | 42560-01 | 122  |
| 41907-04 | 432  | 41960-10 | 109  | 42452-14 | 424  | 42470-64 | 424  | 42519-01 | 167  | 42535-49 | 166  | 42560-02 | 122  |
| 41907-06 | 432  | 41960-12 | 109  | 42452-23 | 424  | 42470-74 | 432  | 42520-00 | 167  | 42537-40 | 165  | 42560-03 | 122  |
| 41907-56 | 422  | 41960-15 | 109  | 42452-35 | 418  | 42470-76 | 432  | 42520-AA | 529  | 42537-50 | 165  | 42560-04 | 123  |

| Cod.     | pag. | Cod.     | pag. | Cod.     | pag. | Cod.     | pag. | Cod.     | pag. | Cod.     | pag. | Cod.     | pag. |
|----------|------|----------|------|----------|------|----------|------|----------|------|----------|------|----------|------|
| 42560-05 | 123  | 42577-94 | 530  | 42616-04 | 105  | 42666S22 | 378  | 42683P18 | 380  | 42727-18 | 383  | 42798S11 | 383  |
| 42560-06 | 123  | 42577-99 | 530  | 42617-04 | 356  | 42666P27 | 378  | 42683S18 | 380  | 42727-22 | 383  | 42800P20 | 387  |
| 42560-07 | 123  | 42579-00 | 163  | 42617-05 | 356  | 42666S27 | 378  | 42684P08 | 382  | 42727-30 | 383  | 42800S20 | 387  |
| 42560-08 | 123  | 42581-01 | 105  | 42617-06 | 356  | 42666P30 | 378  | 42684S08 | 382  | 42727-38 | 383  | 42801P14 | 387  |
| 42560-09 | 123  | 42581-03 | 105  | 42617-07 | 356  | 42666S30 | 378  | 42685P14 | 381  | 42728-09 | 383  | 42801S14 | 387  |
| 42562-12 | 104  | 42581-05 | 105  | 42620P01 | 382  | 42666P40 | 378  | 42685S14 | 381  | 42728-12 | 383  | 42822-00 | 274  |
| 42562-14 | 104  | 42581-10 | 105  | 42620P02 | 382  | 42666S40 | 378  | 42685-22 | 386  | 42728-18 | 383  | 42826-32 | 274  |
| 42562-16 | 104  | 42581-15 | 105  | 42620P03 | 382  | 42667P12 | 379  | 42686P21 | 377  | 42728S18 | 383  | 42826-37 | 274  |
| 42562-18 | 104  | 42581-20 | 105  | 42620P04 | 382  | 42667S12 | 379  | 42686S21 | 377  | 42728-22 | 383  | 42830-08 | 96   |
| 42562-20 | 104  | 42584-01 | 361  | 42623-10 | 100  | 42667P18 | 379  | 42687P18 | 377  | 42728-30 | 383  | 42854B25 | 102  |
| 42562-25 | 104  | 42584-02 | 361  | 42624P10 | 379  | 42667S18 | 379  | 42687S18 | 377  | 42728-38 | 383  | 42854C25 | 102  |
| 42562-30 | 104  | 42584-04 | 361  | 42624S10 | 379  | 42667P22 | 379  | 42687P22 | 377  | 42741-22 | 380  | 42854G25 | 103  |
| 42563-00 | 118  | 42584-05 | 361  | 42650-10 | 116  | 42667S22 | 379  | 42687S22 | 377  | 42742-22 | 380  | 42854K25 | 103  |
| 42563-44 | 119  | 42584-06 | 362  | 42650-11 | 116  | 42667P30 | 379  | 42687P30 | 377  | 42746P12 | 378  | 42854R25 | 103  |
| 42565-00 | 118  | 42584-07 | 362  | 42653-04 | 112  | 42667S30 | 379  | 42687S30 | 377  | 42746P18 | 378  | 42854Y25 | 103  |
| 42566-03 | 117  | 42585-00 | 462  | 42660-02 | 387  | 42668P12 | 378  | 42688P18 | 377  | 42746S18 | 378  | 42854B30 | 102  |
| 42569-04 | 123  | 42585-04 | 462  | 42661-02 | 382  | 42668S12 | 378  | 42688S18 | 377  | 42746P22 | 378  | 42854C30 | 102  |
| 42570-32 | 125  | 42585-06 | 462  | 42661-03 | 382  | 42668P18 | 378  | 42688P22 | 377  | 42746S22 | 378  | 42854G30 | 103  |
| 42570-91 | 529  | 42586-09 | 462  | 42661-06 | 382  | 42668S18 | 378  | 42688S22 | 377  | 42746P30 | 378  | 42854K30 | 103  |
| 42570-92 | 529  | 42586-10 | 462  | 42662C14 | 384  | 42668P22 | 378  | 42688P30 | 377  | 42746S30 | 378  | 42854R30 | 103  |
| 42570-94 | 529  | 42587-04 | 462  | 42662P14 | 384  | 42668S22 | 378  | 42688S30 | 377  | 42746P40 | 378  | 42854Y30 | 103  |
| 42570-99 | 529  | 42588-00 | 116  | 42662S14 | 384  | 42668P30 | 378  | 42692B14 | 387  | 42746P50 | 378  | 42862-00 | 102  |
| 42571-20 | 125  | 42588-01 | 116  | 42663C14 | 385  | 42668S30 | 378  | 42693B14 | 387  | 42746P80 | 378  | 42863-00 | 102  |
| 42572-24 | 125  | 42589-00 | 117  | 42663P14 | 385  | 42668P40 | 378  | 42701-10 | 379  | 42747P12 | 378  | 42864-10 | 164  |
| 42573-31 | 125  | 42590-02 | 107  | 42663S14 | 385  | 42669C14 | 385  | 42701P10 | 379  | 42747S12 | 378  | 42870-50 | 414  |
| 42573-91 | 529  | 42590R02 | 107  | 42664P12 | 379  | 42669P14 | 385  | 42702-10 | 380  | 42747P18 | 378  | 42870-51 | 414  |
| 42573-92 | 529  | 42590-03 | 107  | 42664S12 | 379  | 42669S14 | 385  | 42702P10 | 380  | 42747S18 | 378  | 42870-59 | 419  |
| 42573-94 | 529  | 42590R03 | 107  | 42664P18 | 379  | 42670B14 | 384  | 42703-10 | 379  | 42749P18 | 377  | 42872-02 | 419  |
| 42573-99 | 529  | 42592-01 | 102  | 42664S18 | 379  | 42670N14 | 384  | 42703S10 | 379  | 42749S18 | 377  | 42873-01 | 359  |
| 42574-37 | 125  | 42592-02 | 102  | 42664P22 | 379  | 42670W14 | 384  | 42704-10 | 380  | 42749P22 | 377  | 42873-02 | 420  |
| 42574-90 | 529  | 42593-00 | 363  | 42664S22 | 379  | 42674P18 | 379  | 42704S10 | 380  | 42749S22 | 377  | 42873-65 | 415  |
| 42574-91 | 529  | 42595-01 | 116  | 42664P30 | 379  | 42674S18 | 379  | 42705P10 | 377  | 42764M15 | 385  | 42874-01 | 414  |
| 42574-92 | 529  | 42596-02 | 116  | 42664S30 | 379  | 42674P22 | 379  | 42705S10 | 377  | 42764P16 | 383  | 42874-02 | 414  |
| 42574-93 | 529  | 42597-00 | 115  | 42664P40 | 379  | 42674S22 | 379  | 42705M15 | 385  | 42764S16 | 383  | 42874-03 | 414  |
| 42574-94 | 529  | 42598-00 | 117  | 42665P12 | 378  | 42674P30 | 379  | 42705P16 | 383  | 42764P21 | 383  | 42874-04 | 414  |
| 42574-99 | 529  | 42599-06 | 118  | 42665S12 | 378  | 42674S30 | 379  | 42705S16 | 383  | 42764S21 | 383  | 42875-17 | 358  |
| 42575-37 | 125  | 42599-08 | 118  | 42665P18 | 378  | 42676P15 | 381  | 42705P21 | 383  | 42767P12 | 381  | 42875B17 | 358  |
| 42575-90 | 529  | 42607-05 | 203  | 42665S18 | 378  | 42676S15 | 381  | 42705S21 | 383  | 42767S12 | 381  | 42875-20 | 358  |
| 42575-91 | 529  | 42609-10 | 107  | 42665P22 | 378  | 42676P20 | 381  | 42707P21 | 380  | 42767P15 | 381  | 42875B20 | 358  |
| 42575-92 | 529  | 42609-15 | 107  | 42665S22 | 378  | 42676S20 | 381  | 42707S21 | 380  | 42767S15 | 381  | 42876-20 | 359  |
| 42575-93 | 529  | 42609-20 | 107  | 42665P30 | 378  | 42677P14 | 381  | 42710-11 | 381  | 42767P20 | 381  | 42876B20 | 359  |
| 42575-94 | 529  | 42609-23 | 107  | 42665S30 | 378  | 42677S14 | 381  | 42720-00 | 385  | 42767S20 | 381  | 42876-25 | 359  |
| 42575-99 | 529  | 42609-25 | 107  | 42665P40 | 378  | 42678P14 | 384  | 42720-01 | 386  | 42785S20 | 387  | 42876B25 | 359  |
| 42576-00 | 124  | 42614-04 | 255  | 42665S40 | 378  | 42678S14 | 384  | 42723P10 | 386  | 42786S20 | 387  | 42877-17 | 358  |
| 42577-39 | 124  | 42614-05 | 255  | 42666P12 | 378  | 42678W14 | 384  | 42723S10 | 386  | 42796P16 | 383  | 42877-25 | 358  |
| 42577-90 | 530  | 42614-06 | 255  | 42666S12 | 378  | 42680-13 | 386  | 42725P10 | 386  | 42796S16 | 383  | 42878-17 | 358  |
| 42577-91 | 530  | 42614-07 | 255  | 42666P18 | 378  | 42681-16 | 387  | 42725S10 | 386  | 42796P23 | 383  | 42878-25 | 358  |
| 42577-92 | 530  | 42614-21 | 203  | 42666S18 | 378  | 42682P18 | 380  | 42727-09 | 383  | 42796S23 | 383  | 42879K12 | 358  |
| 42577-93 | 530  | 42615-04 | 105  | 42666P22 | 378  | 42682S18 | 380  | 42727-12 | 383  | 42798P11 | 383  | 42879M12 | 357  |



**NUMERICAL INDEX INDICE NUMERICO NUMERISCH INDEX INDEX NUMERIQUE INDICE NUMERICO**

| Cod.     | pag. | Cod.     | pag. | Cod.     | pag. | Cod.     | pag. | Cod.     | pag. | Cod.     | pag. | Cod.     | pag. |
|----------|------|----------|------|----------|------|----------|------|----------|------|----------|------|----------|------|
| 42879K15 | 358  | 42935-19 | 358  | 42956-28 | 357  | 42972-04 | 417  | 44030-03 | 476  | 44060-50 | 103  | 44103-04 | 324  |
| 42879M15 | 357  | 42935-26 | 358  | 42959-12 | 365  | 42972-28 | 416  | 44031-01 | 477  | 44060-51 | 326  | 44103-06 | 324  |
| 42879K22 | 358  | 42936-23 | 417  | 42959-13 | 365  | 42973-30 | 416  | 44031-02 | 477  | 44060-80 | 103  | 44103-AA | 531  |
| 42879M22 | 357  | 42936-24 | 417  | 42962-04 | 426  | 42973-45 | 416  | 44031-04 | 463  | 44060-99 | 326  | 44103-AB | 531  |
| 42879K25 | 358  | 42936-28 | 417  | 42962-26 | 426  | 42973-60 | 416  | 44031-05 | 463  | 44061-08 | 103  | 44103-AC | 531  |
| 42879M25 | 357  | 42939-15 | 370  | 42962C26 | 426  | 42973-61 | 416  | 44033-23 | 467  | 44061-09 | 103  | 44104-01 | 286  |
| 42900-15 | 101  | 42939-AA | 530  | 42962-30 | 426  | 42974B13 | 358  | 44033-38 | 467  | 44061-12 | 103  | 44104-02 | 286  |
| 42900-24 | 101  | 42940-03 | 407  | 42962-44 | 426  | 42974C13 | 358  | 44034-11 | 467  | 44061-14 | 103  | 44104-15 | 286  |
| 42901-20 | 101  | 42941-22 | 371  | 42962C44 | 426  | 42974M13 | 358  | 44040-40 | 464  | 44077-00 | 484  | 44105-00 | 318  |
| 42901-25 | 101  | 42941-AA | 530  | 42963-55 | 415  | 42974N13 | 358  | 44041-00 | 464  | 44077-06 | 484  | 44106B05 | 323  |
| 42901-30 | 101  | 42942-16 | 369  | 42964-53 | 167  | 42979-00 | 407  | 44041-01 | 464  | 44077-10 | 484  | 44106G05 | 322  |
| 42901-35 | 101  | 42944-23 | 358  | 42964-60 | 167  | 42979-36 | 407  | 44041-03 | 464  | 44077-CC | 484  | 44106O05 | 323  |
| 42901-40 | 101  | 42945-18 | 358  | 42965-12 | 417  | 42979-45 | 407  | 44041-04 | 464  | 44089-12 | 486  | 44106R05 | 323  |
| 42902-30 | 102  | 42945-23 | 358  | 42967-03 | 416  | 42980-01 | 408  | 44041-05 | 464  | 44093-00 | 411  | 44106W05 | 322  |
| 42902B30 | 309  | 42945-27 | 358  | 42967-04 | 416  | 42980-02 | 408  | 44042-00 | 464  | 44093-01 | 411  | 44106Y05 | 322  |
| 42902C30 | 309  | 42946-23 | 417  | 42967-05 | 416  | 42981-73 | 407  | 44043-00 | 464  | 44094-00 | 457  | 44106B10 | 323  |
| 42902G30 | 309  | 42946-37 | 417  | 42967-06 | 416  | 42982-08 | 407  | 44044-00 | 464  | 44094R00 | 457  | 44106G10 | 322  |
| 42902-31 | 102  | 42947-23 | 417  | 42967-07 | 416  | 42988-99 | 397  | 44047-17 | 463  | 44094-01 | 457  | 44106O10 | 323  |
| 42903-29 | 103  | 42947-30 | 417  | 42967-08 | 416  | 42988C99 | 397  | 44047-19 | 463  | 44094-02 | 457  | 44106R10 | 323  |
| 42904-01 | 102  | 42947-40 | 417  | 42967-11 | 418  | 42988G99 | 397  | 44047-22 | 463  | 44094-03 | 458  | 44106W10 | 322  |
| 42904-02 | 102  | 42948-18 | 358  | 42967-13 | 416  | 42990-16 | 419  | 44047-25 | 463  | 44094-04 | 458  | 44106Y10 | 322  |
| 42904-03 | 102  | 42948-20 | 358  | 42967-14 | 416  | 42990M16 | 419  | 44047-28 | 463  | 44094-05 | 458  | 44106-12 | 324  |
| 42907-01 | 101  | 42948-23 | 358  | 42967-15 | 416  | 42990N16 | 419  | 44048-99 | 330  | 44094-06 | 458  | 44106B20 | 323  |
| 42907-02 | 101  | 42948-25 | 358  | 42967-16 | 416  | 42990-20 | 419  | 44055-10 | 327  | 44094-RE | 530  | 44106G20 | 322  |
| 42907-03 | 101  | 42949-26 | 420  | 42967-17 | 416  | 42990M20 | 419  | 44055-20 | 327  | 44095-12 | 486  | 44106O20 | 323  |
| 42907-04 | 101  | 42950-01 | 347  | 42967-18 | 416  | 42990N20 | 419  | 44055-25 | 327  | 44095-18 | 486  | 44106R20 | 323  |
| 42907-06 | 101  | 42950-02 | 347  | 42967-35 | 416  | 42990-29 | 419  | 44055-30 | 327  | 44095-30 | 477  | 44106W20 | 322  |
| 42907-07 | 101  | 42950-03 | 347  | 42967-43 | 417  | 42990M29 | 419  | 44055C30 | 327  | 44095-32 | 477  | 44106Y20 | 322  |
| 42907-08 | 101  | 42950-04 | 347  | 42967-53 | 417  | 42990N29 | 419  | 44055G30 | 327  | 44096-01 | 481  | 44106B25 | 323  |
| 42907-09 | 101  | 42950-05 | 347  | 42967-63 | 415  | 42991-25 | 418  | 44055-35 | 327  | 44096-02 | 481  | 44106G25 | 322  |
| 42907-10 | 101  | 42950-06 | 347  | 42967-64 | 415  | 42991M25 | 418  | 44055-40 | 327  | 44096-03 | 481  | 44106O25 | 323  |
| 42907-30 | 101  | 42950-07 | 347  | 42967-65 | 415  | 42991N25 | 418  | 44055C40 | 327  | 44096-80 | 486  | 44106R25 | 323  |
| 42907-35 | 101  | 42950-08 | 347  | 42967-66 | 415  | 42991-32 | 418  | 44055G40 | 327  | 44096B80 | 486  | 44106W25 | 322  |
| 42907-40 | 101  | 42950-09 | 347  | 42967-67 | 415  | 42991M32 | 418  | 44055-50 | 327  | 44096G80 | 486  | 44106Y25 | 322  |
| 42908-24 | 112  | 42950-92 | 347  | 42967-68 | 415  | 42991N32 | 418  | 44056-01 | 327  | 44096R80 | 486  | 44107B05 | 323  |
| 42920-02 | 285  | 42950-93 | 347  | 42967-73 | 415  | 42993-40 | 419  | 44056-04 | 326  | 44096Y80 | 486  | 44107G05 | 323  |
| 42921-00 | 361  | 42950-94 | 347  | 42967-74 | 415  | 42993M40 | 419  | 44056-06 | 326  | 44097-00 | 485  | 44107O05 | 323  |
| 42923-07 | 285  | 42951-08 | 371  | 42967-75 | 415  | 42993N40 | 419  | 44056-11 | 327  | 44098-03 | 486  | 44107R05 | 323  |
| 42924-02 | 359  | 42951-57 | 371  | 42967-76 | 415  | 44009-00 | 463  | 44056-21 | 327  | 44098-08 | 486  | 44107W05 | 323  |
| 42926-12 | 360  | 42951-59 | 372  | 42967-77 | 415  | 44020-21 | 463  | 44057-04 | 326  | 44098-12 | 486  | 44107Y05 | 323  |
| 42927-02 | 360  | 42952-05 | 371  | 42967-78 | 415  | 44023-00 | 462  | 44057-06 | 326  | 44098-24 | 486  | 44107B10 | 323  |
| 42928-00 | 360  | 42953-04 | 362  | 42968-38 | 416  | 44023-AA | 530  | 44058-10 | 325  | 44099-03 | 324  | 44107G10 | 323  |
| 42929-01 | 360  | 42954-04 | 371  | 42968-42 | 417  | 44024-00 | 462  | 44058-20 | 327  | 44100-01 | 324  | 44107O10 | 323  |
| 42929-02 | 360  | 42954-18 | 371  | 42969-11 | 417  | 44025-50 | 463  | 44058-25 | 327  | 44100-02 | 324  | 44107R10 | 323  |
| 42929-03 | 360  | 42954-29 | 371  | 42969-31 | 417  | 44026-60 | 478  | 44058-30 | 327  | 44100-04 | 324  | 44107W10 | 323  |
| 42929-AA | 530  | 42954-46 | 371  | 42969-36 | 417  | 44027-00 | 463  | 44058-40 | 327  | 44101-03 | 324  | 44107Y10 | 323  |
| 42929-AB | 530  | 42955-00 | 362  | 42972-01 | 417  | 44027-AA | 530  | 44058-50 | 327  | 44101-AA | 531  | 44107B20 | 323  |
| 42929-AC | 530  | 42956-19 | 357  | 42972-02 | 417  | 44028-19 | 466  | 44060-01 | 326  | 44102-24 | 320  | 44107G20 | 323  |
| 42931-19 | 359  | 42956-24 | 357  | 42972-03 | 417  | 44029-00 | 463  | 44060-02 | 326  | 44103-03 | 324  | 44107O20 | 323  |

| Cod.     | pag. | Cod.     | pag. | Cod.     | pag. | Cod.     | pag. | Cod.     | pag. | Cod.     | pag. | Cod.     | pag. |
|----------|------|----------|------|----------|------|----------|------|----------|------|----------|------|----------|------|
| 44107R20 | 323  | 44150-19 | 482  | 44183-01 | 495  | 44205-28 | 43   | 44233-20 | 46   | 44262-42 | 340  | 44337B06 | 75   |
| 44107W20 | 323  | 44151-00 | 482  | 44183-A3 | 495  | 44207-16 | 44   | 44234-12 | 46   | 44263-36 | 340  | 44338-03 | 75   |
| 44107Y20 | 323  | 44151-AA | 482  | 44183-A4 | 495  | 44207-20 | 44   | 44234S12 | 47   | 44264-35 | 340  | 44338-06 | 75   |
| 44107B25 | 323  | 44151-AB | 482  | 44184-01 | 495  | 44207-24 | 44   | 44234-16 | 46   | 44265-35 | 340  | 44339-03 | 75   |
| 44107G25 | 323  | 44151-AC | 482  | 44184-A3 | 495  | 44207-28 | 44   | 44234S16 | 47   | 44312A06 | 77   | 44339-06 | 75   |
| 44107O25 | 323  | 44160-03 | 482  | 44184-A4 | 495  | 44208G00 | 44   | 44235-16 | 47   | 44312B06 | 77   | 44342-06 | 77   |
| 44107R25 | 323  | 44160-AA | 531  | 44201-01 | 42   | 44208R00 | 44   | 44236S28 | 47   | 44312G06 | 77   | 44343-06 | 77   |
| 44107W25 | 323  | 44161-00 | 483  | 44201-03 | 42   | 44209R26 | 44   | 44236S34 | 47   | 44312O06 | 77   | 44344-06 | 77   |
| 44107Y25 | 323  | 44164-00 | 483  | 44201-10 | 42   | 44209R32 | 44   | 44237S15 | 47   | 44312R06 | 77   | 44345-06 | 77   |
| 44108-01 | 320  | 44165-35 | 484  | 44201B10 | 42   | 44210-26 | 44   | 44238-15 | 47   | 44312Y06 | 77   | 44346-06 | 77   |
| 44108-02 | 320  | 44165-40 | 484  | 44201N10 | 42   | 44210S26 | 44   | 44239R16 | 43   | 44313B06 | 77   | 44347-06 | 77   |
| 44110-00 | 328  | 44165-50 | 484  | 44201O10 | 42   | 44210-32 | 44   | 44240-08 | 47   | 44313G06 | 77   | 44352-30 | 447  |
| 44110-01 | 327  | 44166-28 | 483  | 44201R10 | 42   | 44210S32 | 44   | 44240S08 | 42   | 44313O06 | 77   | 44352-40 | 447  |
| 44110-02 | 327  | 44167-13 | 483  | 44201V10 | 42   | 44210-42 | 44   | 44241-19 | 47   | 44313R06 | 77   | 44355-30 | 447  |
| 44110-03 | 327  | 44168-12 | 485  | 44201B12 | 42   | 44210S42 | 44   | 44242-00 | 47   | 44313Y06 | 77   | 44355-40 | 447  |
| 44110-04 | 327  | 44169B06 | 485  | 44201N12 | 42   | 44212-30 | 45   | 44243-00 | 47   | 44314A06 | 77   | 44357-10 | 357  |
| 44110-05 | 327  | 44169R06 | 485  | 44201O12 | 42   | 44213-24 | 45   | 44244S30 | 48   | 44314B06 | 77   | 44357B10 | 357  |
| 44110-06 | 327  | 44169B14 | 485  | 44201R12 | 42   | 44213-36 | 45   | 44244S36 | 48   | 44314G06 | 77   | 44357-15 | 357  |
| 44111-02 | 327  | 44169R25 | 485  | 44201V12 | 42   | 44214-25 | 45   | 44245S32 | 47   | 44314O06 | 77   | 44357B15 | 357  |
| 44112-01 | 328  | 44170-00 | 483  | 44201N16 | 42   | 44215S16 | 45   | 44246S11 | 48   | 44314R06 | 77   | 44366-10 | 372  |
| 44112-02 | 328  | 44170-01 | 483  | 44201R16 | 42   | 44216S16 | 44   | 44246S14 | 48   | 44314Y06 | 77   | 44371-24 | 50   |
| 44114-01 | 328  | 44171-24 | 484  | 44201N20 | 42   | 44217-45 | 45   | 44246S17 | 48   | 44315A06 | 77   | 44371-28 | 50   |
| 44114-02 | 328  | 44171-50 | 484  | 44201R20 | 42   | 44218R30 | 44   | 44247S16 | 48   | 44315B06 | 77   | 44371-32 | 50   |
| 44114-03 | 328  | 44172-30 | 485  | 44201N24 | 42   | 44218R40 | 44   | 44247-38 | 43   | 44315G06 | 77   | 44371-36 | 50   |
| 44118-10 | 328  | 44173-00 | 484  | 44201R24 | 42   | 44219R26 | 44   | 44248S60 | 339  | 44315O06 | 77   | 44371-40 | 50   |
| 44118-20 | 328  | 44174-24 | 481  | 44201N28 | 42   | 44220S24 | 45   | 44249S30 | 339  | 44315R06 | 77   | 44371-44 | 50   |
| 44118-25 | 328  | 44174-AA | 531  | 44201R28 | 42   | 44220S32 | 48   | 44249S35 | 339  | 44315Y06 | 77   | 44371-48 | 50   |
| 44118-30 | 328  | 44175-15 | 482  | 44201N32 | 42   | 44220S38 | 48   | 44250S30 | 339  | 44317A06 | 77   | 44372-26 | 50   |
| 44118-35 | 328  | 44176-30 | 482  | 44201R32 | 42   | 44220-AA | 531  | 44250S35 | 339  | 44317B06 | 77   | 44372-32 | 50   |
| 44118-40 | 328  | 44177-12 | 482  | 44202-10 | 42   | 44221S30 | 45   | 44251-01 | 365  | 44317G06 | 77   | 44372-36 | 50   |
| 44118-50 | 328  | 44178-01 | 480  | 44202B12 | 42   | 44222-20 | 45   | 44251-03 | 365  | 44317O06 | 77   | 44372-40 | 50   |
| 44119-01 | 328  | 44178-02 | 480  | 44202N12 | 42   | 44222S20 | 45   | 44254-30 | 339  | 44317R06 | 77   | 44374-22 | 50   |
| 44119-02 | 328  | 44178-15 | 480  | 44202O12 | 42   | 44222-28 | 45   | 44255-08 | 48   | 44317Y06 | 77   | 44374-25 | 50   |
| 44119-03 | 328  | 44178-16 | 480  | 44202R12 | 42   | 44222S28 | 45   | 44255-10 | 47   | 44322-02 | 60   | 44374-32 | 50   |
| 44119-04 | 328  | 44178-17 | 481  | 44202V12 | 42   | 44223S19 | 47   | 44255-12 | 48   | 44322-04 | 60   | 44374-36 | 50   |
| 44119-06 | 328  | 44178-18 | 481  | 44202N25 | 43   | 44224-22 | 45   | 44255-14 | 48   | 44322-06 | 60   | 44374-40 | 50   |
| 44130-01 | 326  | 44178-19 | 481  | 44202R25 | 42   | 44224S22 | 46   | 44255-15 | 48   | 44332-03 | 74   | 44374-44 | 50   |
| 44130-02 | 326  | 44178-20 | 481  | 44202N27 | 43   | 44225-22 | 46   | 44255-16 | 48   | 44332-06 | 74   | 44375-25 | 50   |
| 44130-03 | 326  | 44178-66 | 488  | 44202R27 | 42   | 44226S30 | 46   | 44255-21 | 48   | 44332B06 | 74   | 44376-40 | 50   |
| 44135-02 | 326  | 44178-67 | 488  | 44202N29 | 43   | 44227-30 | 46   | 44255-22 | 48   | 44333-03 | 75   | 44379-05 | 357  |
| 44141-01 | 483  | 44178-69 | 488  | 44202R29 | 42   | 44228S23 | 46   | 44256-01 | 340  | 44333-06 | 75   | 44382A06 | 74   |
| 44141-03 | 483  | 44180-01 | 496  | 44203R20 | 42   | 44229S20 | 46   | 44256-02 | 340  | 44333B06 | 75   | 44382B06 | 74   |
| 44142-40 | 483  | 44180-02 | 496  | 44203R24 | 42   | 44230S10 | 46   | 44256-03 | 340  | 44334-03 | 75   | 44382G06 | 74   |
| 44147-00 | 484  | 44181-01 | 496  | 44203R28 | 42   | 44230S14 | 46   | 44256-04 | 340  | 44334-06 | 75   | 44382O06 | 74   |
| 44147-01 | 484  | 44181-02 | 496  | 44204R24 | 43   | 44231-14 | 46   | 44258-60 | 339  | 44335-03 | 75   | 44382Y06 | 74   |
| 44147-02 | 484  | 44182-01 | 496  | 44204R28 | 43   | 44232S12 | 46   | 44259-29 | 340  | 44335-06 | 75   | 44383O06 | 75   |
| 44147-03 | 484  | 44182-02 | 496  | 44205-16 | 43   | 44232S16 | 46   | 44260-30 | 275  | 44335B06 | 75   | 44383Y06 | 75   |
| 44148-01 | 483  | 44182-03 | 496  | 44205-20 | 43   | 44232S20 | 46   | 44260-34 | 275  | 44337-03 | 75   | 44384A06 | 75   |
| 44149-03 | 482  | 44182-04 | 496  | 44205-24 | 43   | 44233-16 | 46   | 44261-46 | 340  | 44337-06 | 75   | 44384O06 | 75   |

**NUMERICAL INDEX INDICE NUMERICO NUMERISCH INDEX INDEX NUMERIQUE INDICE NUMERICO**

| Cod.            | pag.       | Cod.            | pag.       | Cod.            | pag.       | Cod.            | pag.       | Cod.            | pag.       | Cod.            | pag.       | Cod.            | pag.       |
|-----------------|------------|-----------------|------------|-----------------|------------|-----------------|------------|-----------------|------------|-----------------|------------|-----------------|------------|
| <u>44384R06</u> | <u>75</u>  | <u>44450-13</u> | <u>258</u> | <u>44470-40</u> | <u>400</u> | <u>44477-55</u> | <u>401</u> | <u>44480-10</u> | <u>350</u> | <u>44513-90</u> | <u>468</u> | <u>44820-99</u> | <u>476</u> |
| <u>44384Y06</u> | <u>75</u>  | <u>44450B13</u> | <u>258</u> | <u>44470-73</u> | <u>400</u> | <u>44477-64</u> | <u>401</u> | <u>44480-11</u> | <u>350</u> | <u>44521E10</u> | <u>468</u> | <u>44822-80</u> | <u>476</u> |
| <u>44385A06</u> | <u>75</u>  | <u>44450-15</u> | <u>258</u> | <u>44470-74</u> | <u>400</u> | <u>44477-65</u> | <u>401</u> | <u>44480-12</u> | <u>350</u> | <u>44521-16</u> | <u>468</u> | <u>44822-99</u> | <u>476</u> |
| <u>44385B06</u> | <u>75</u>  | <u>44450B15</u> | <u>258</u> | <u>44470-75</u> | <u>400</u> | <u>44477-66</u> | <u>401</u> | <u>44480-13</u> | <u>350</u> | <u>44521-21</u> | <u>468</u> | <u>44825-20</u> | <u>477</u> |
| <u>44385G06</u> | <u>75</u>  | <u>44450-17</u> | <u>258</u> | <u>44471-11</u> | <u>337</u> | <u>44477-67</u> | <u>401</u> | <u>44480-14</u> | <u>350</u> | <u>44521-31</u> | <u>468</u> | <u>44825-40</u> | <u>477</u> |
| <u>44385O06</u> | <u>75</u>  | <u>44450B17</u> | <u>258</u> | <u>44471-12</u> | <u>337</u> | <u>44477-68</u> | <u>401</u> | <u>44480-15</u> | <u>351</u> | <u>44522E10</u> | <u>468</u> | <u>44826-00</u> | <u>476</u> |
| <u>44385R06</u> | <u>75</u>  | <u>44450-21</u> | <u>258</u> | <u>44471-13</u> | <u>337</u> | <u>44477-69</u> | <u>401</u> | <u>44480-16</u> | <u>351</u> | <u>44522-16</u> | <u>468</u> | <u>44826-20</u> | <u>477</u> |
| <u>44385Y06</u> | <u>75</u>  | <u>44450B21</u> | <u>258</u> | <u>44471-14</u> | <u>337</u> | <u>44477-76</u> | <u>402</u> | <u>44480-17</u> | <u>351</u> | <u>44522-21</u> | <u>468</u> | <u>44830-52</u> | <u>473</u> |
| <u>44387A06</u> | <u>75</u>  | <u>44450-23</u> | <u>258</u> | <u>44471-24</u> | <u>337</u> | <u>44477-77</u> | <u>402</u> | <u>44480-18</u> | <u>351</u> | <u>44522-31</u> | <u>468</u> | <u>44830-72</u> | <u>473</u> |
| <u>44387B06</u> | <u>75</u>  | <u>44450B23</u> | <u>258</u> | <u>44473-02</u> | <u>275</u> | <u>44477-78</u> | <u>402</u> | <u>44480-19</u> | <u>351</u> | <u>44620-01</u> | <u>465</u> | <u>44830-99</u> | <u>473</u> |
| <u>44387G06</u> | <u>75</u>  | <u>44451-22</u> | <u>258</u> | <u>44473-03</u> | <u>275</u> | <u>44477-79</u> | <u>402</u> | <u>44480-20</u> | <u>351</u> | <u>44620-02</u> | <u>465</u> | <u>44831-52</u> | <u>473</u> |
| <u>44387O06</u> | <u>75</u>  | <u>44451B22</u> | <u>258</u> | <u>44473-05</u> | <u>336</u> | <u>44477-80</u> | <u>402</u> | <u>44501-01</u> | <u>26</u>  | <u>44620-03</u> | <u>465</u> | <u>44832-99</u> | <u>473</u> |
| <u>44387R06</u> | <u>75</u>  | <u>44452-31</u> | <u>257</u> | <u>44473-07</u> | <u>337</u> | <u>44477-81</u> | <u>402</u> | <u>44501-02</u> | <u>26</u>  | <u>44620-04</u> | <u>465</u> | <u>44833-99</u> | <u>473</u> |
| <u>44387Y06</u> | <u>75</u>  | <u>44452B31</u> | <u>257</u> | <u>44473-08</u> | <u>337</u> | <u>44478-20</u> | <u>351</u> | <u>44501-03</u> | <u>26</u>  | <u>44620-05</u> | <u>465</u> | <u>44834-00</u> | <u>398</u> |
| <u>44389-32</u> | <u>50</u>  | <u>44453-14</u> | <u>257</u> | <u>44473-31</u> | <u>336</u> | <u>44478-21</u> | <u>351</u> | <u>44501-04</u> | <u>26</u>  | <u>44620-06</u> | <u>465</u> | <u>44834G00</u> | <u>398</u> |
| <u>44390-07</u> | <u>50</u>  | <u>44453B14</u> | <u>257</u> | <u>44473-32</u> | <u>336</u> | <u>44478-22</u> | <u>351</u> | <u>44502-01</u> | <u>26</u>  | <u>44620-07</u> | <u>465</u> | <u>44834-01</u> | <u>398</u> |
| <u>44390-09</u> | <u>50</u>  | <u>44454-11</u> | <u>257</u> | <u>44473-33</u> | <u>336</u> | <u>44478-23</u> | <u>351</u> | <u>44502-02</u> | <u>26</u>  | <u>44620-14</u> | <u>465</u> | <u>44834G01</u> | <u>398</u> |
| <u>44390-11</u> | <u>50</u>  | <u>44454B11</u> | <u>257</u> | <u>44473-34</u> | <u>336</u> | <u>44478-24</u> | <u>351</u> | <u>44502-03</u> | <u>26</u>  | <u>44620-17</u> | <u>465</u> | <u>44834-02</u> | <u>398</u> |
| <u>44390-15</u> | <u>50</u>  | <u>44455-09</u> | <u>257</u> | <u>44475-76</u> | <u>289</u> | <u>44478-25</u> | <u>351</u> | <u>44502-04</u> | <u>26</u>  | <u>44625-03</u> | <u>465</u> | <u>44834G02</u> | <u>398</u> |
| <u>44390-18</u> | <u>50</u>  | <u>44455B09</u> | <u>257</u> | <u>44475-77</u> | <u>289</u> | <u>44478-26</u> | <u>351</u> | <u>44503-01</u> | <u>26</u>  | <u>44625-04</u> | <u>465</u> | <u>44834-03</u> | <u>398</u> |
| <u>44390-23</u> | <u>50</u>  | <u>44456-14</u> | <u>257</u> | <u>44475-78</u> | <u>289</u> | <u>44478-27</u> | <u>351</u> | <u>44503-02</u> | <u>26</u>  | <u>44625-05</u> | <u>465</u> | <u>44834G03</u> | <u>398</u> |
| <u>44391-12</u> | <u>50</u>  | <u>44456B14</u> | <u>257</u> | <u>44475-79</u> | <u>289</u> | <u>44478-28</u> | <u>351</u> | <u>44503-03</u> | <u>26</u>  | <u>44625-06</u> | <u>465</u> | <u>44835-36</u> | <u>398</u> |
| <u>44394-18</u> | <u>50</u>  | <u>44457-32</u> | <u>257</u> | <u>44475-80</u> | <u>289</u> | <u>44478-29</u> | <u>351</u> | <u>44503-04</u> | <u>26</u>  | <u>44625-07</u> | <u>465</u> | <u>44835G36</u> | <u>398</u> |
| <u>44394-21</u> | <u>50</u>  | <u>44457B32</u> | <u>257</u> | <u>44475-81</u> | <u>289</u> | <u>44478-30</u> | <u>351</u> | <u>44505-10</u> | <u>472</u> | <u>44625-08</u> | <u>465</u> | <u>44835-45</u> | <u>398</u> |
| <u>44395-18</u> | <u>50</u>  | <u>44459-28</u> | <u>258</u> | <u>44475-82</u> | <u>289</u> | <u>44478-31</u> | <u>351</u> | <u>44505-15</u> | <u>472</u> | <u>44625-26</u> | <u>465</u> | <u>44835G45</u> | <u>398</u> |
| <u>44397-18</u> | <u>50</u>  | <u>44459B28</u> | <u>258</u> | <u>44475-83</u> | <u>289</u> | <u>44478-32</u> | <u>351</u> | <u>44505-20</u> | <u>472</u> | <u>44625-34</u> | <u>465</u> | <u>44835-53</u> | <u>398</u> |
| <u>44412-00</u> | <u>60</u>  | <u>44461-20</u> | <u>258</u> | <u>44476-20</u> | <u>405</u> | <u>44478-33</u> | <u>351</u> | <u>44505-25</u> | <u>472</u> | <u>44630-01</u> | <u>133</u> | <u>44835G53</u> | <u>398</u> |
| <u>44421-00</u> | <u>60</u>  | <u>44461B20</u> | <u>258</u> | <u>44476-26</u> | <u>405</u> | <u>44478-34</u> | <u>351</u> | <u>44506-09</u> | <u>472</u> | <u>44630-02</u> | <u>134</u> | <u>44836-30</u> | <u>398</u> |
| <u>44422-00</u> | <u>60</u>  | <u>44462-25</u> | <u>258</u> | <u>44476-27</u> | <u>405</u> | <u>44478-35</u> | <u>351</u> | <u>44511E21</u> | <u>467</u> | <u>44630-03</u> | <u>134</u> | <u>44836G30</u> | <u>398</u> |
| <u>44423-00</u> | <u>60</u>  | <u>44462B25</u> | <u>258</u> | <u>44476-28</u> | <u>405</u> | <u>44478-70</u> | <u>403</u> | <u>44511-27</u> | <u>468</u> | <u>44630-04</u> | <u>134</u> | <u>44837-05</u> | <u>424</u> |
| <u>44430-60</u> | <u>194</u> | <u>44463-11</u> | <u>257</u> | <u>44476-29</u> | <u>405</u> | <u>44478-71</u> | <u>403</u> | <u>44511-34</u> | <u>468</u> | <u>44630-05</u> | <u>134</u> | <u>44837B05</u> | <u>424</u> |
| <u>44430-61</u> | <u>194</u> | <u>44464-23</u> | <u>257</u> | <u>44476-30</u> | <u>405</u> | <u>44478-72</u> | <u>403</u> | <u>44511-38</u> | <u>468</u> | <u>44630-06</u> | <u>134</u> | <u>44837-20</u> | <u>424</u> |
| <u>44431-46</u> | <u>194</u> | <u>44465-24</u> | <u>257</u> | <u>44476-31</u> | <u>405</u> | <u>44478-73</u> | <u>404</u> | <u>44511-42</u> | <u>468</u> | <u>44630-07</u> | <u>134</u> | <u>44837B20</u> | <u>424</u> |
| <u>44431-60</u> | <u>194</u> | <u>44466-07</u> | <u>296</u> | <u>44476-32</u> | <u>405</u> | <u>44478-74</u> | <u>404</u> | <u>44511-63</u> | <u>468</u> | <u>44801-09</u> | <u>476</u> | <u>44837C20</u> | <u>424</u> |
| <u>44432-21</u> | <u>60</u>  | <u>44466-11</u> | <u>396</u> | <u>44476-33</u> | <u>405</u> | <u>44478-75</u> | <u>404</u> | <u>44511E63</u> | <u>467</u> | <u>44801-18</u> | <u>477</u> | <u>44837-25</u> | <u>424</u> |
| <u>44446-10</u> | <u>399</u> | <u>44466-12</u> | <u>396</u> | <u>44476-51</u> | <u>405</u> | <u>44478-76</u> | <u>404</u> | <u>44511-90</u> | <u>468</u> | <u>44803-10</u> | <u>475</u> | <u>44837B25</u> | <u>424</u> |
| <u>44446B10</u> | <u>399</u> | <u>44466-13</u> | <u>396</u> | <u>44476-52</u> | <u>405</u> | <u>44478-77</u> | <u>403</u> | <u>44511E90</u> | <u>467</u> | <u>44803-20</u> | <u>475</u> | <u>44840-01</u> | <u>394</u> |
| <u>44446-14</u> | <u>399</u> | <u>44466-14</u> | <u>396</u> | <u>44476-53</u> | <u>405</u> | <u>44478-78</u> | <u>403</u> | <u>44512E12</u> | <u>467</u> | <u>44803-30</u> | <u>475</u> | <u>44840-02</u> | <u>394</u> |
| <u>44446B14</u> | <u>399</u> | <u>44466-15</u> | <u>396</u> | <u>44477-24</u> | <u>401</u> | <u>44478-79</u> | <u>403</u> | <u>44512E21</u> | <u>467</u> | <u>44807-18</u> | <u>476</u> | <u>44840-03</u> | <u>394</u> |
| <u>44446-18</u> | <u>399</u> | <u>44466-16</u> | <u>396</u> | <u>44477-25</u> | <u>401</u> | <u>44478-80</u> | <u>403</u> | <u>44512-34</u> | <u>468</u> | <u>44807-28</u> | <u>475</u> | <u>44840-04</u> | <u>394</u> |
| <u>44446B18</u> | <u>399</u> | <u>44466-30</u> | <u>296</u> | <u>44477-26</u> | <u>401</u> | <u>44480-00</u> | <u>350</u> | <u>44512-42</u> | <u>468</u> | <u>44807-36</u> | <u>475</u> | <u>44840-05</u> | <u>394</u> |
| <u>44449-30</u> | <u>399</u> | <u>44470-03</u> | <u>400</u> | <u>44477-27</u> | <u>401</u> | <u>44480-01</u> | <u>350</u> | <u>44512-63</u> | <u>468</u> | <u>44818-11</u> | <u>73</u>  | <u>44840-06</u> | <u>425</u> |
| <u>44449B30</u> | <u>399</u> | <u>44470-04</u> | <u>400</u> | <u>44477-28</u> | <u>401</u> | <u>44480-03</u> | <u>350</u> | <u>44512-90</u> | <u>468</u> | <u>44818-12</u> | <u>73</u>  | <u>44840-07</u> | <u>425</u> |
| <u>44449-32</u> | <u>399</u> | <u>44470-11</u> | <u>400</u> | <u>44477-40</u> | <u>401</u> | <u>44480-04</u> | <u>350</u> | <u>44513E12</u> | <u>467</u> | <u>44818-13</u> | <u>73</u>  | <u>44840-08</u> | <u>405</u> |
| <u>44449B32</u> | <u>399</u> | <u>44470-12</u> | <u>400</u> | <u>44477-41</u> | <u>401</u> | <u>44480-05</u> | <u>350</u> | <u>44513E21</u> | <u>467</u> | <u>44818-14</u> | <u>73</u>  | <u>44840-10</u> | <u>405</u> |
| <u>44450-11</u> | <u>258</u> | <u>44470-13</u> | <u>400</u> | <u>44477-44</u> | <u>401</u> | <u>44480-06</u> | <u>350</u> | <u>44513-34</u> | <u>468</u> | <u>44818-16</u> | <u>73</u>  | <u>44840-18</u> | <u>405</u> |
| <u>44450B11</u> | <u>258</u> | <u>44470-14</u> | <u>400</u> | <u>44477-52</u> | <u>401</u> | <u>44480-07</u> | <u>350</u> | <u>44513-38</u> | <u>468</u> | <u>44819-02</u> | <u>476</u> | <u>44840-27</u> | <u>353</u> |
| <u>44450-12</u> | <u>258</u> | <u>44470-24</u> | <u>400</u> | <u>44477-53</u> | <u>401</u> | <u>44480-08</u> | <u>350</u> | <u>44513-54</u> | <u>468</u> | <u>44819-03</u> | <u>476</u> | <u>44840-28</u> | <u>353</u> |
| <u>44450B12</u> | <u>258</u> | <u>44470-30</u> | <u>400</u> | <u>44477-54</u> | <u>401</u> | <u>44480-09</u> | <u>350</u> | <u>44513-63</u> | <u>468</u> | <u>44820-80</u> | <u>476</u> | <u>44840-30</u> | <u>404</u> |

| Cod.     | pag. | Cod.     | pag. | Cod.     | pag. | Cod.     | pag. | Cod.     | pag. | Cod.     | pag. | Cod.     | pag. |
|----------|------|----------|------|----------|------|----------|------|----------|------|----------|------|----------|------|
| 44840-31 | 404  | 44847-09 | 395  | 44877B12 | 73   | 44940-10 | 314  | 44960-02 | 277  | 44982-10 | 255  | 47020-35 | 191  |
| 44840-32 | 404  | 44847B09 | 394  | 44877-13 | 73   | 44940-11 | 314  | 44960-03 | 277  | 44986-12 | 469  | 47021-30 | 191  |
| 44840-40 | 404  | 44847-13 | 395  | 44877B13 | 73   | 44940-12 | 314  | 44960-04 | 277  | 44986-17 | 469  | 47021-35 | 191  |
| 44840-41 | 404  | 44847B13 | 394  | 44877-14 | 73   | 44940-13 | 314  | 44960-06 | 277  | 44986-21 | 469  | 47021-45 | 191  |
| 44840-42 | 404  | 44847-20 | 395  | 44877B14 | 73   | 44940-14 | 314  | 44960-07 | 277  | 44986-28 | 469  | 47022-12 | 203  |
| 44840-50 | 403  | 44847B20 | 394  | 44877-16 | 73   | 44940-16 | 314  | 44960-10 | 277  | 44987-11 | 470  | 47023-01 | 285  |
| 44840-51 | 403  | 44849-27 | 397  | 44877B16 | 73   | 44940-17 | 314  | 44960K10 | 278  | 44987C11 | 470  | 47023-02 | 285  |
| 44840-52 | 403  | 44849-34 | 397  | 44877-24 | 72   | 44940-18 | 315  | 44960-11 | 277  | 44987-60 | 470  | 47023-03 | 285  |
| 44840-55 | 403  | 44849-47 | 397  | 44877B24 | 72   | 44940-19 | 315  | 44960K11 | 278  | 44987C60 | 470  | 47023-04 | 285  |
| 44840-56 | 403  | 44850-00 | 397  | 44878-11 | 72   | 44940-24 | 315  | 44960-13 | 277  | 44987C62 | 469  | 47024-06 | 200  |
| 44840-57 | 403  | 44850B00 | 397  | 44878B11 | 72   | 44940-25 | 315  | 44961-02 | 470  | 44990-15 | 315  | 47024-10 | 200  |
| 44841-18 | 395  | 44850W00 | 397  | 44878-12 | 73   | 44940-26 | 315  | 44961-03 | 276  | 44990-24 | 315  | 47025-06 | 200  |
| 44841-21 | 395  | 44850-11 | 397  | 44878B12 | 73   | 44940-32 | 315  | 44961M03 | 276  | 44990-29 | 315  | 47025-10 | 200  |
| 44841-26 | 395  | 44850B11 | 397  | 44878-13 | 73   | 44940-33 | 315  | 44961-04 | 469  | 44990-36 | 315  | 47026-06 | 200  |
| 44841-37 | 395  | 44850-12 | 397  | 44878B13 | 73   | 44940-34 | 315  | 44961-05 | 469  | 44990-48 | 315  | 47027-11 | 201  |
| 44841-51 | 395  | 44850B12 | 397  | 44878-14 | 73   | 44941B05 | 305  | 44961-06 | 469  | 44992-02 | 355  | 47027-12 | 201  |
| 44841B51 | 395  | 44850G12 | 397  | 44878B14 | 73   | 44941C05 | 305  | 44962-01 | 277  | 44992-03 | 354  | 47027-13 | 201  |
| 44842-30 | 396  | 44850-13 | 260  | 44878-16 | 73   | 44941G05 | 305  | 44962-05 | 278  | 44993-01 | 355  | 47027-14 | 201  |
| 44842-31 | 396  | 44850B13 | 260  | 44878B16 | 73   | 44942-01 | 316  | 44968-00 | 470  | 44994-00 | 355  | 47027-15 | 201  |
| 44842B31 | 396  | 44851-01 | 397  | 44878-24 | 72   | 44942-02 | 316  | 44970-10 | 469  | 44995-10 | 355  | 47027-16 | 201  |
| 44842-35 | 396  | 44851-02 | 397  | 44878B24 | 72   | 44942-03 | 316  | 44970-15 | 469  | 44995-14 | 355  | 47028-12 | 200  |
| 44842-53 | 396  | 44851-03 | 397  | 44882-35 | 401  | 44942-04 | 316  | 44970-20 | 469  | 44995-15 | 355  | 47029-12 | 200  |
| 44842B53 | 396  | 44871-20 | 315  | 44882-46 | 401  | 44942-05 | 317  | 44970-34 | 469  | 44997-22 | 104  | 47030-30 | 201  |
| 44843-11 | 396  | 44871B20 | 315  | 44884-12 | 426  | 44942-06 | 295  | 44972-20 | 469  | 44997-24 | 104  | 47031-44 | 198  |
| 44843B11 | 396  | 44871G20 | 315  | 44884B12 | 426  | 44942-07 | 295  | 44972-25 | 469  | 44997-26 | 104  | 47031-46 | 198  |
| 44843-12 | 396  | 44871L20 | 315  | 44884-19 | 426  | 44942-10 | 295  | 44972-33 | 469  | 44997-28 | 104  | 47032-10 | 201  |
| 44843B12 | 396  | 44871R20 | 315  | 44884B19 | 426  | 44942-11 | 295  | 44973-10 | 469  | 44998-31 | 104  | 47032-20 | 201  |
| 44843-13 | 396  | 44871-21 | 315  | 44884-25 | 426  | 44942-12 | 295  | 44973-20 | 469  | 44999-09 | 354  | 47033-08 | 201  |
| 44843B13 | 396  | 44871B21 | 316  | 44884B25 | 426  | 44944C07 | 303  | 44974-21 | 469  | 44999-16 | 354  | 47033-12 | 201  |
| 44843-14 | 396  | 44871G21 | 316  | 44885-19 | 426  | 44944G07 | 303  | 44974-27 | 469  | 46116-15 | 320  | 47033-14 | 201  |
| 44843B14 | 396  | 44871L21 | 316  | 44885-25 | 426  | 44945C05 | 303  | 44974-31 | 469  | 46118-20 | 367  | 47033-50 | 198  |
| 44843-24 | 396  | 44871R21 | 316  | 44888-32 | 401  | 44945G05 | 303  | 44975-35 | 276  | 46120-18 | 367  | 47034-23 | 201  |
| 44843B24 | 396  | 44871-22 | 315  | 44888-35 | 401  | 44946-04 | 408  | 44975H35 | 276  | 46120-22 | 367  | 47034-50 | 201  |
| 44844-01 | 395  | 44871-23 | 315  | 44888-40 | 401  | 44946B05 | 408  | 44975-50 | 276  | 46120-24 | 367  | 47034-51 | 201  |
| 44844B01 | 395  | 44871-28 | 316  | 44889-32 | 401  | 44947-00 | 165  | 44975C50 | 462  | 46123-00 | 369  | 47034-52 | 201  |
| 44844-11 | 395  | 44871-29 | 316  | 44889-35 | 401  | 44947-07 | 116  | 44975H50 | 276  | 46796-00 | 328  | 47035-40 | 201  |
| 44845-30 | 396  | 44871-30 | 316  | 44889-40 | 401  | 44948-07 | 306  | 44976-01 | 471  | 46970-18 | 28   | 47035-48 | 201  |
| 44845-31 | 288  | 44871-31 | 316  | 44930-10 | 472  | 44949-01 | 307  | 44976-02 | 471  | 46970-25 | 28   | 47036-30 | 201  |
| 44845-38 | 288  | 44871-32 | 316  | 44930-20 | 472  | 44949-02 | 307  | 44976-03 | 471  | 47005-24 | 212  | 47036-35 | 201  |
| 44845-41 | 396  | 44871-33 | 316  | 44932-15 | 472  | 44949-03 | 307  | 44976-04 | 470  | 47006-25 | 212  | 47036-40 | 201  |
| 44845-51 | 396  | 44871-34 | 316  | 44932-20 | 472  | 44949-04 | 307  | 44977-12 | 472  | 47007-26 | 217  | 47036-45 | 201  |
| 44846-05 | 395  | 44871-35 | 316  | 44934-30 | 472  | 44949-05 | 307  | 44978-10 | 469  | 47010-20 | 192  | 47036-50 | 201  |
| 44846B05 | 395  | 44873-08 | 288  | 44936-02 | 472  | 44949-06 | 307  | 44978-20 | 469  | 47011-01 | 205  | 47036-60 | 201  |
| 44846-09 | 395  | 44873-16 | 288  | 44936-20 | 472  | 44950-15 | 357  | 44979-02 | 470  | 47014-35 | 214  | 47037-30 | 201  |
| 44846B09 | 395  | 44874-08 | 289  | 44936-57 | 472  | 44950-20 | 357  | 44979-04 | 470  | 47018-30 | 214  | 47037-40 | 201  |
| 44846-13 | 395  | 44874-16 | 289  | 44940-01 | 313  | 44950-25 | 357  | 44979-05 | 470  | 47018-50 | 214  | 47038-50 | 201  |
| 44846B13 | 395  | 44877-11 | 72   | 44940-02 | 313  | 44950-30 | 357  | 44979-06 | 470  | 47020-15 | 191  | 47038-60 | 201  |
| 44846-15 | 395  | 44877B11 | 72   | 44940-06 | 313  | 44950-38 | 357  | 44982-04 | 255  | 47020-20 | 191  | 47039-05 | 202  |
| 44846B15 | 395  | 44877-12 | 73   | 44940-08 | 313  | 44960-01 | 277  | 44982-06 | 255  | 47020-30 | 191  | 47039-10 | 202  |

**NUMERICAL INDEX INDICE NUMERICO NUMERISCH INDEX INDEX NUMERIQUE INDICE NUMERICO**

| <u>Cod.</u> | <u>pag.</u> | <u>Cod.</u> | <u>pag.</u> | <u>Cod.</u> | <u>pag.</u> | <u>Cod.</u> | <u>pag.</u> | <u>Cod.</u> | <u>pag.</u> | <u>Cod.</u> | <u>pag.</u> | <u>Cod.</u> | <u>pag.</u> |
|-------------|-------------|-------------|-------------|-------------|-------------|-------------|-------------|-------------|-------------|-------------|-------------|-------------|-------------|
| 47039-15    | 202         | 47068-15    | 210         | 47105-60    | 191         | 47130-60    | 206         | 47302-10    | 171         | 47354-04    | 187         | 47357-44    | 188         |
| 47040-00    | 255         | 47069-10    | 210         | 47105-65    | 191         | 47131-30    | 206         | 47303-10    | 171         | 47354-06    | 187         | 47357-50    | 188         |
| 47041-01    | 254         | 47069-12    | 210         | 47105-70    | 191         | 47131-60    | 206         | 47304-06    | 171         | 47354-08    | 187         | 47357-51    | 188         |
| 47041-02    | 254         | 47069-14    | 210         | 47105-75    | 191         | 47200-01    | 190         | 47304-10    | 171         | 47354-10    | 187         | 47370-01    | 178         |
| 47041-03    | 254         | 47069-16    | 210         | 47106-28    | 191         | 47200-02    | 190         | 47304-12    | 171         | 47354-12    | 187         | 47370-02    | 178         |
| 47041-04    | 254         | 47069-18    | 210         | 47106-34    | 191         | 47207-20    | 187         | 47305-12    | 171         | 47354-14    | 187         | 47370-03    | 178         |
| 47041-05    | 254         | 47069-20    | 210         | 47106-40    | 191         | 47207-25    | 187         | 47306-10    | 171         | 47354-16    | 187         | 47370-08    | 173         |
| 47041-06    | 254         | 47070-37    | 204         | 47106-46    | 191         | 47207-30    | 187         | 47307-10    | 171         | 47354-18    | 187         | 47371-08    | 177         |
| 47041-07    | 254         | 47070-48    | 204         | 47106-50    | 191         | 47208-01    | 186         | 47308-10    | 171         | 47355-02    | 187         | 47372-08    | 174         |
| 47041-08    | 254         | 47070-60    | 204         | 47106-55    | 191         | 47208-02    | 186         | 47310-10    | 171         | 47355-04    | 187         | 47373-01    | 175         |
| 47041-15    | 254         | 47074-01    | 204         | 47106-60    | 191         | 47208-03    | 186         | 47312-10    | 171         | 47355-06    | 187         | 47373-02    | 178         |
| 47042-19    | 255         | 47074-02    | 204         | 47106-65    | 191         | 47208-04    | 186         | 47314-10    | 171         | 47355-08    | 187         | 47373-08    | 175         |
| 47042-22    | 255         | 47074-03    | 204         | 47106-70    | 191         | 47208-05    | 186         | 47315-10    | 171         | 47355-10    | 187         | 47374-01    | 178         |
| 47042-25    | 255         | 47074-04    | 204         | 47106-75    | 191         | 47208-06    | 186         | 47316-10    | 171         | 47355-12    | 187         | 47374-02    | 178         |
| 47043-27    | 255         | 47074-05    | 204         | 47107-00    | 193         | 47208-07    | 186         | 47316-12    | 171         | 47356-02    | 187         | 47374-08    | 178         |
| 47043-35    | 255         | 47074-06    | 204         | 47108-00    | 193         | 47208-08    | 186         | 47316-20    | 171         | 47356-04    | 187         | 47375-01    | 177         |
| 47043-42    | 255         | 47074-07    | 204         | 47110-23    | 193         | 47208-09    | 186         | 47317-10    | 171         | 47356-06    | 187         | 47375-08    | 177         |
| 47060-06    | 210         | 47074-08    | 204         | 47111-30    | 192         | 47208-10    | 186         | 47317-12    | 172         | 47356-08    | 187         | 47376-08    | 175         |
| 47060-07    | 210         | 47075-20    | 204         | 47111-40    | 192         | 47208-11    | 186         | 47317-20    | 172         | 47356-10    | 187         | 47377-01    | 176         |
| 47060-09    | 210         | 47075-30    | 204         | 47111-46    | 192         | 47208-12    | 186         | 47321-12    | 172         | 47356-12    | 187         | 47377-02    | 176         |
| 47060-10    | 210         | 47075-45    | 204         | 47111-55    | 192         | 47208-13    | 186         | 47322-12    | 172         | 47356-14    | 187         | 47377-03    | 176         |
| 47060-12    | 210         | 47090-23    | 288         | 47112-34    | 192         | 47208-14    | 186         | 47323-12    | 172         | 47356-16    | 187         | 47377-04    | 176         |
| 47060-14    | 210         | 47091-01    | 288         | 47112-45    | 192         | 47208-15    | 186         | 47324-12    | 172         | 47356-18    | 187         | 47377-05    | 176         |
| 47060-16    | 210         | 47091-02    | 288         | 47112-50    | 192         | 47208-16    | 186         | 47325-10    | 172         | 47357-01    | 185         | 47377-06    | 176         |
| 47060-18    | 210         | 47093-24    | 116         | 47113-03    | 193         | 47208-17    | 187         | 47326-10    | 172         | 47357-02    | 185         | 47377-07    | 176         |
| 47060-20    | 210         | 47094-30    | 193         | 47114-40    | 192         | 47208-18    | 187         | 47327-12    | 172         | 47357-03    | 185         | 47377-08    | 173         |
| 47060-22    | 210         | 47098-18    | 194         | 47114-55    | 192         | 47208-19    | 187         | 47328-15    | 172         | 47357-06    | 184         | 47377-09    | 175         |
| 47060-24    | 210         | 47098-22    | 194         | 47118-30    | 192         | 47208-20    | 187         | 47331-15    | 172         | 47357-07    | 184         | 47377-10    | 175         |
| 47060-26    | 210         | 47098-26    | 194         | 47118-40    | 192         | 47208-21    | 187         | 47332-12    | 172         | 47357-08    | 184         | 47377-11    | 176         |
| 47060-30    | 210         | 47098-30    | 194         | 47118-55    | 192         | 47208-22    | 187         | 47333-15    | 172         | 47357-09    | 184         | 47377-12    | 179         |
| 47062-18    | 210         | 47099-30    | 288         | 47118-65    | 192         | 47208-23    | 187         | 47334-12    | 172         | 47357-10    | 185         | 47377-15    | 179         |
| 47062-20    | 210         | 47100-03    | 407         | 47119-30    | 192         | 47208-24    | 187         | 47335-12    | 172         | 47357-11    | 185         | 47378-01    | 178         |
| 47062-22    | 210         | 47100-04    | 407         | 47119-35    | 192         | 47212-01    | 190         | 47336-42    | 172         | 47357-20    | 182         | 47378-02    | 178         |
| 47063-01    | 210         | 47100-05    | 407         | 47119-40    | 192         | 47212-02    | 190         | 47350-01    | 186         | 47357-21    | 182         | 47378-08    | 173         |
| 47063-02    | 210         | 47100-06    | 407         | 47119-45    | 192         | 47212-03    | 190         | 47351-01    | 186         | 47357-22    | 182         | 47379-08    | 173         |
| 47063-05    | 210         | 47100-07    | 407         | 47119-50    | 192         | 47212-05    | 190         | 47352-01    | 186         | 47357-23    | 183         | 47380-08    | 177         |
| 47063-07    | 210         | 47100-08    | 407         | 47119-60    | 192         | 47214-86    | 188         | 47353-02    | 187         | 47357-24    | 182         | 47381-08    | 178         |
| 47063-10    | 210         | 47101-30    | 193         | 47120-01    | 191         | 47215-86    | 188         | 47353-04    | 187         | 47357-25    | 183         | 47382-06    | 177         |
| 47064-18    | 210         | 47101-31    | 288         | 47120-02    | 191         | 47216-88    | 188         | 47353-06    | 187         | 47357-26    | 183         | 47382-08    | 175         |
| 47064-22    | 210         | 47101-40    | 193         | 47127-04    | 187         | 47219-29    | 189         | 47353-08    | 187         | 47357-27    | 183         | 47383-08    | 177         |
| 47064-26    | 210         | 47103-30    | 193         | 47127-06    | 187         | 47219-38    | 189         | 47353-10    | 187         | 47357-28    | 183         | 47384-01    | 177         |
| 47064-30    | 210         | 47103-32    | 193         | 47127-08    | 187         | 47219-55    | 189         | 47353-12    | 187         | 47357-29    | 183         | 47384-08    | 177         |
| 47066-03    | 210         | 47104-45    | 192         | 47130-25    | 206         | 47250-12    | 188         | 47353-14    | 187         | 47357-30    | 184         | 47385-01    | 178         |
| 47066-04    | 210         | 47105-28    | 191         | 47130-30    | 206         | 47250-24    | 188         | 47353-16    | 187         | 47357-31    | 184         | 47385-08    | 178         |
| 47066-05    | 210         | 47105-34    | 191         | 47130-35    | 206         | 47251-00    | 189         | 47353-18    | 187         | 47357-38    | 189         | 47386-08    | 177         |
| 47066-06    | 210         | 47105-40    | 191         | 47130-40    | 206         | 47251-01    | 189         | 47353-20    | 187         | 47357-40    | 188         | 47387-01    | 174         |
| 47066-07    | 210         | 47105-46    | 191         | 47130-45    | 206         | 47251-02    | 190         | 47353-22    | 187         | 47357-41    | 188         | 47387-02    | 175         |
| 47066-08    | 210         | 47105-50    | 191         | 47130-50    | 206         | 47251-03    | 190         | 47353-24    | 187         | 47357-42    | 188         | 47388-06    | 179         |
| 47068-12    | 210         | 47105-55    | 191         | 47130-55    | 206         | 47301-12    | 171         | 47354-02    | 187         | 47357-43    | 188         | 47388-07    | 179         |

| Cod.     | pag. | Cod.     | pag. | Cod.     | pag. | Cod.     | pag. | Cod.     | pag. | Cod.     | pag. | Cod.     | pag. |
|----------|------|----------|------|----------|------|----------|------|----------|------|----------|------|----------|------|
| 47388-08 | 179  | 47510-21 | 209  | 47532-14 | 206  | 47540-02 | 208  | 47604-20 | 105  | 47621-07 | 203  | 47655-04 | 220  |
| 47401-08 | 177  | 47510-23 | 209  | 47532-16 | 206  | 47540-03 | 208  | 47604-24 | 105  | 47621-08 | 203  | 47655-05 | 220  |
| 47402-01 | 174  | 47510-25 | 209  | 47532-18 | 206  | 47540-04 | 208  | 47604-30 | 105  | 47621-11 | 279  | 47655-07 | 220  |
| 47402-02 | 175  | 47510-27 | 209  | 47532-20 | 206  | 47540-05 | 208  | 47605-23 | 104  | 47621-12 | 279  | 47656-01 | 220  |
| 47402-08 | 174  | 47510-29 | 209  | 47532-22 | 206  | 47541-02 | 208  | 47606-02 | 105  | 47622-01 | 181  | 47656-02 | 220  |
| 47404-01 | 177  | 47510-31 | 209  | 47532-24 | 206  | 47541-03 | 208  | 47606-05 | 105  | 47622-02 | 181  | 47656-03 | 220  |
| 47404-02 | 177  | 47511-07 | 209  | 47532-26 | 206  | 47541-04 | 208  | 47606-10 | 105  | 47622-03 | 181  | 47656-04 | 220  |
| 47404-03 | 177  | 47511-09 | 209  | 47533-07 | 206  | 47542-00 | 207  | 47606-20 | 105  | 47622-04 | 180  | 47656-05 | 220  |
| 47404-04 | 177  | 47511-11 | 209  | 47533-08 | 206  | 47542-18 | 208  | 47606-30 | 105  | 47622-26 | 180  | 47656-07 | 220  |
| 47404-05 | 177  | 47511-13 | 209  | 47533-09 | 206  | 47542-20 | 208  | 47606-50 | 105  | 47625-03 | 203  | 47657-01 | 220  |
| 47404-08 | 177  | 47511-15 | 209  | 47533-10 | 206  | 47542-22 | 208  | 47607-10 | 105  | 47626-55 | 198  | 47657-02 | 220  |
| 47411-01 | 174  | 47511-17 | 209  | 47533-12 | 206  | 47542-24 | 208  | 47607-20 | 105  | 47627-01 | 198  | 47657-03 | 220  |
| 47411-02 | 174  | 47511-19 | 209  | 47533-14 | 206  | 47542-26 | 208  | 47608-02 | 105  | 47630-28 | 181  | 47657-04 | 220  |
| 47411-03 | 174  | 47511-21 | 209  | 47533-16 | 206  | 47544-20 | 208  | 47609-02 | 105  | 47631-08 | 181  | 47657-05 | 220  |
| 47411-08 | 173  | 47511-23 | 209  | 47533-18 | 206  | 47544-25 | 208  | 47609-03 | 105  | 47631-12 | 181  | 47657-07 | 220  |
| 47412-08 | 173  | 47511-25 | 209  | 47533-20 | 206  | 47544-30 | 208  | 47609-04 | 106  | 47640-25 | 202  | 47658-01 | 220  |
| 47413-01 | 174  | 47511-27 | 209  | 47533-22 | 206  | 47546-18 | 207  | 47609-07 | 106  | 47640-35 | 202  | 47658-02 | 220  |
| 47413-08 | 174  | 47511-29 | 209  | 47533-24 | 206  | 47546-21 | 208  | 47609-09 | 105  | 47642-30 | 202  | 47658-03 | 220  |
| 47414-03 | 172  | 47511-31 | 209  | 47533-26 | 206  | 47546-22 | 208  | 47609-12 | 106  | 47642-40 | 202  | 47658-04 | 220  |
| 47415-03 | 172  | 47512-07 | 209  | 47533-28 | 206  | 47546-23 | 208  | 47609-13 | 105  | 47642-50 | 202  | 47658-05 | 220  |
| 47416-06 | 172  | 47512-09 | 209  | 47533-30 | 206  | 47546-30 | 207  | 47609-16 | 106  | 47642-60 | 202  | 47658-07 | 220  |
| 47417-06 | 173  | 47512-11 | 209  | 47533-32 | 206  | 47546-40 | 207  | 47610-18 | 109  | 47642-70 | 202  | 47659-01 | 217  |
| 47418-00 | 173  | 47512-13 | 209  | 47534-00 | 207  | 47546-41 | 208  | 47610-22 | 109  | 47643-30 | 202  | 47659-02 | 217  |
| 47419-10 | 172  | 47512-15 | 209  | 47534-01 | 207  | 47546-42 | 208  | 47610-26 | 109  | 47643-40 | 202  | 47659-03 | 217  |
| 47421-09 | 179  | 47512-17 | 209  | 47534-06 | 207  | 47546-43 | 208  | 47610-30 | 109  | 47643-50 | 202  | 47659-04 | 217  |
| 47422-26 | 179  | 47512-19 | 209  | 47534-07 | 206  | 47546-51 | 208  | 47611-01 | 110  | 47643-60 | 202  | 47670-02 | 217  |
| 47425-01 | 179  | 47512-21 | 209  | 47534-08 | 206  | 47546-52 | 208  | 47611-03 | 110  | 47643-70 | 202  | 47672-05 | 217  |
| 47425-02 | 179  | 47512-23 | 209  | 47534-09 | 206  | 47546-53 | 208  | 47611-05 | 110  | 47644-15 | 202  | 47674-01 | 218  |
| 47425-03 | 179  | 47512-25 | 209  | 47534-10 | 206  | 47547-22 | 208  | 47611-06 | 110  | 47645-40 | 202  | 47674-02 | 218  |
| 47425-04 | 179  | 47512-27 | 209  | 47534-16 | 207  | 47547-26 | 208  | 47611-09 | 110  | 47645-60 | 202  | 47674-03 | 218  |
| 47425-05 | 179  | 47512-29 | 209  | 47534-18 | 207  | 47547-30 | 208  | 47611-11 | 110  | 47645-75 | 202  | 47674-04 | 218  |
| 47425-06 | 179  | 47512-31 | 209  | 47534-20 | 207  | 47548-02 | 207  | 47611-13 | 110  | 47646-40 | 202  | 47674-05 | 218  |
| 47425-08 | 179  | 47526-05 | 207  | 47534-22 | 207  | 47548-03 | 207  | 47611-14 | 110  | 47646-60 | 202  | 47674-06 | 218  |
| 47425-09 | 179  | 47527-55 | 207  | 47534-24 | 207  | 47548-04 | 207  | 47611-15 | 110  | 47646-75 | 202  | 47674-07 | 218  |
| 47425-10 | 179  | 47528-05 | 207  | 47534-26 | 207  | 47548-05 | 207  | 47611-16 | 110  | 47651-01 | 220  | 47674-08 | 218  |
| 47425-11 | 179  | 47529-07 | 207  | 47534-28 | 207  | 47600-16 | 110  | 47611-19 | 110  | 47651-02 | 220  | 47675-01 | 219  |
| 47425-26 | 179  | 47530-14 | 206  | 47535-09 | 209  | 47600-20 | 110  | 47611-23 | 110  | 47651-03 | 220  | 47675-02 | 219  |
| 47425-29 | 179  | 47530-16 | 206  | 47535-12 | 209  | 47600-24 | 110  | 47612-01 | 195  | 47651-04 | 220  | 47675-03 | 219  |
| 47425-30 | 179  | 47530-18 | 206  | 47535-15 | 209  | 47600-28 | 110  | 47612-AA | 531  | 47651-05 | 220  | 47675-04 | 219  |
| 47425-32 | 179  | 47530-20 | 206  | 47535-17 | 209  | 47600-32 | 110  | 47614-25 | 203  | 47651-07 | 220  | 47675-05 | 219  |
| 47426-01 | 179  | 47530-22 | 206  | 47535-19 | 209  | 47600-36 | 110  | 47615-25 | 203  | 47652-01 | 220  | 47675-06 | 219  |
| 47426-07 | 179  | 47530-24 | 206  | 47536-12 | 209  | 47600-40 | 110  | 47618-10 | 188  | 47652-02 | 220  | 47675-07 | 219  |
| 47510-07 | 209  | 47530-26 | 206  | 47536-14 | 209  | 47603-25 | 104  | 47618-20 | 188  | 47652-03 | 220  | 47675-08 | 219  |
| 47510-09 | 209  | 47530-28 | 206  | 47536-16 | 209  | 47603-27 | 104  | 47621-01 | 202  | 47652-04 | 220  | 47675-09 | 219  |
| 47510-11 | 209  | 47530-30 | 206  | 47536-18 | 209  | 47604-08 | 105  | 47621-02 | 202  | 47652-05 | 220  | 47677-01 | 218  |
| 47510-13 | 209  | 47532-06 | 206  | 47536-20 | 209  | 47604-10 | 105  | 47621-03 | 202  | 47652-07 | 220  | 47677-02 | 218  |
| 47510-15 | 209  | 47532-07 | 206  | 47538-20 | 208  | 47604-12 | 105  | 47621-04 | 202  | 47655-01 | 220  | 47677-03 | 218  |
| 47510-17 | 209  | 47532-08 | 206  | 47538-23 | 208  | 47604-15 | 105  | 47621-05 | 203  | 47655-02 | 220  | 47677-04 | 218  |
| 47510-19 | 209  | 47532-12 | 206  | 47538-26 | 208  | 47604-18 | 105  | 47621-06 | 203  | 47655-03 | 220  | 47677-05 | 218  |

**NUMERICAL INDEX INDICE NUMERICO NUMERISCH INDEX INDEX NUMERIQUE INDICE NUMERICO**

| Cod.     | pag. | Cod.     | pag. | Cod.     | pag. | Cod.     | pag. | Cod.     | pag. | Cod.     | pag. | Cod.     | pag. |
|----------|------|----------|------|----------|------|----------|------|----------|------|----------|------|----------|------|
| 47677-06 | 218  | 47698-02 | 197  | 47723-10 | 215  | 47740-20 | 245  | 47740-74 | 240  | 47740127 | 241  | 47742-27 | 234  |
| 47677-07 | 218  | 47698-03 | 197  | 47723-12 | 215  | 47740-23 | 239  | 47740-75 | 240  | 47740128 | 239  | 47742-29 | 236  |
| 47677-08 | 218  | 47698-06 | 197  | 47724-06 | 215  | 47740-24 | 245  | 47740-77 | 242  | 47740129 | 248  | 47742-30 | 234  |
| 47677-09 | 219  | 47698-07 | 197  | 47724-08 | 215  | 47740-25 | 245  | 47740-79 | 246  | 47740130 | 242  | 47742-31 | 234  |
| 47677-10 | 219  | 47705-22 | 213  | 47724-10 | 215  | 47740-26 | 239  | 47740-80 | 239  | 47740131 | 243  | 47742-33 | 236  |
| 47677-11 | 219  | 47709-20 | 212  | 47724-11 | 215  | 47740-27 | 239  | 47740-81 | 243  | 47740132 | 241  | 47742-34 | 235  |
| 47677-12 | 219  | 47709-24 | 212  | 47725-09 | 215  | 47740-28 | 239  | 47740-82 | 243  | 47740133 | 243  | 47742-37 | 235  |
| 47677-14 | 219  | 47709-28 | 212  | 47726-07 | 214  | 47740-29 | 239  | 47740-83 | 240  | 47740134 | 248  | 47742-41 | 234  |
| 47677-18 | 219  | 47709-32 | 212  | 47727-07 | 214  | 47740-30 | 244  | 47740-84 | 247  | 47740135 | 240  | 47742-42 | 235  |
| 47677-19 | 219  | 47710-12 | 212  | 47728-06 | 214  | 47740-31 | 246  | 47740-85 | 244  | 47740137 | 239  | 47742-47 | 236  |
| 47677-20 | 219  | 47710-16 | 212  | 47730-24 | 215  | 47740-32 | 243  | 47740-86 | 247  | 47740138 | 239  | 47742-48 | 236  |
| 47679-10 | 203  | 47710-20 | 212  | 47730-36 | 215  | 47740-33 | 247  | 47740-87 | 246  | 47740140 | 241  | 47742-51 | 235  |
| 47679-11 | 203  | 47710-24 | 212  | 47730-60 | 215  | 47740-34 | 243  | 47740-88 | 248  | 47740141 | 239  | 47742-56 | 235  |
| 47680-40 | 205  | 47710-28 | 212  | 47731-12 | 216  | 47740-35 | 248  | 47740-89 | 241  | 47740142 | 243  | 47742-61 | 236  |
| 47680-53 | 205  | 47710-32 | 212  | 47732-20 | 216  | 47740-36 | 245  | 47740-90 | 247  | 47740143 | 243  | 47743-03 | 249  |
| 47680-60 | 205  | 47711-08 | 212  | 47733-18 | 213  | 47740-37 | 241  | 47740-91 | 247  | 47740144 | 242  | 47743-05 | 249  |
| 47681-60 | 204  | 47711-12 | 212  | 47733-24 | 213  | 47740-38 | 241  | 47740-92 | 244  | 47740145 | 245  | 47743-10 | 249  |
| 47682-53 | 204  | 47711-22 | 212  | 47733-30 | 213  | 47740-39 | 244  | 47740-93 | 239  | 47741-00 | 249  | 47743-13 | 249  |
| 47682-60 | 204  | 47711-24 | 212  | 47733-36 | 213  | 47740-41 | 242  | 47740-94 | 242  | 47741-01 | 250  | 47743-15 | 249  |
| 47684-15 | 217  | 47711-26 | 212  | 47734-18 | 213  | 47740-43 | 240  | 47740-95 | 241  | 47741-02 | 250  | 47743-16 | 249  |
| 47685-53 | 205  | 47712-20 | 212  | 47735-18 | 213  | 47740-44 | 243  | 47740-96 | 248  | 47741-05 | 250  | 47743-65 | 249  |
| 47685-60 | 205  | 47712-24 | 212  | 47736-30 | 214  | 47740-45 | 244  | 47740-97 | 242  | 47741-37 | 250  | 47744-10 | 251  |
| 47686-10 | 193  | 47712-28 | 212  | 47736-35 | 214  | 47740-46 | 244  | 47740-98 | 246  | 47741-38 | 250  | 47744-19 | 251  |
| 47686-12 | 193  | 47712-32 | 212  | 47736-40 | 214  | 47740-47 | 244  | 47740-99 | 246  | 47741-76 | 249  | 47744-21 | 251  |
| 47686-14 | 193  | 47713-22 | 213  | 47736-50 | 214  | 47740-48 | 244  | 47740100 | 246  | 47741-77 | 249  | 47744-30 | 250  |
| 47686-17 | 193  | 47714-26 | 213  | 47738-23 | 213  | 47740-49 | 244  | 47740101 | 242  | 47741-78 | 249  | 47744-31 | 250  |
| 47686-22 | 193  | 47714-28 | 213  | 47739-12 | 212  | 47740-50 | 242  | 47740102 | 240  | 47742-00 | 237  | 47744-32 | 250  |
| 47686-24 | 193  | 47715-30 | 213  | 47739-24 | 212  | 47740-51 | 246  | 47740103 | 240  | 47742-01 | 236  | 47744-33 | 250  |
| 47686-26 | 193  | 47716-37 | 214  | 47739-28 | 212  | 47740-52 | 240  | 47740104 | 244  | 47742-02 | 234  | 47744-34 | 250  |
| 47686-30 | 193  | 47717-35 | 213  | 47739-32 | 212  | 47740-53 | 248  | 47740105 | 239  | 47742-03 | 236  | 47744-36 | 251  |
| 47686-33 | 193  | 47718-20 | 213  | 47740-01 | 246  | 47740-55 | 244  | 47740106 | 243  | 47742-04 | 236  | 47744-37 | 251  |
| 47686-36 | 193  | 47719-10 | 213  | 47740-02 | 241  | 47740-56 | 245  | 47740107 | 247  | 47742-05 | 236  | 47744-48 | 251  |
| 47686-42 | 193  | 47719-24 | 213  | 47740-03 | 241  | 47740-57 | 241  | 47740108 | 248  | 47742-06 | 236  | 47744-58 | 251  |
| 47687-24 | 193  | 47720-06 | 215  | 47740-04 | 244  | 47740-58 | 241  | 47740109 | 247  | 47742-07 | 236  | 47744-59 | 251  |
| 47688-60 | 205  | 47720-08 | 215  | 47740-05 | 245  | 47740-59 | 241  | 47740110 | 248  | 47742-08 | 236  | 47744-60 | 251  |
| 47689-53 | 204  | 47720-10 | 215  | 47740-06 | 240  | 47740-60 | 240  | 47740111 | 243  | 47742-09 | 235  | 47744-62 | 251  |
| 47689-60 | 204  | 47720-12 | 215  | 47740-07 | 247  | 47740-61 | 240  | 47740112 | 248  | 47742-10 | 236  | 47744-63 | 251  |
| 47691-53 | 204  | 47721-08 | 215  | 47740-08 | 247  | 47740-62 | 245  | 47740113 | 249  | 47742-12 | 234  | 47744-70 | 251  |
| 47691-64 | 204  | 47721-10 | 215  | 47740-09 | 246  | 47740-63 | 245  | 47740114 | 245  | 47742-13 | 235  | 47744-71 | 251  |
| 47692-01 | 199  | 47721-12 | 215  | 47740-10 | 240  | 47740-64 | 245  | 47740115 | 246  | 47742-14 | 235  | 47744-80 | 250  |
| 47692-02 | 199  | 47722-05 | 215  | 47740-11 | 246  | 47740-65 | 245  | 47740116 | 247  | 47742-15 | 236  | 47744-81 | 250  |
| 47692-03 | 199  | 47722-06 | 215  | 47740-12 | 247  | 47740-66 | 245  | 47740117 | 248  | 47742-16 | 236  | 47745-02 | 233  |
| 47693-00 | 199  | 47722-07 | 215  | 47740-13 | 244  | 47740-67 | 246  | 47740118 | 248  | 47742-17 | 235  | 47745-03 | 233  |
| 47693-03 | 199  | 47722-08 | 215  | 47740-14 | 247  | 47740-68 | 243  | 47740119 | 240  | 47742-19 | 235  | 47745-04 | 233  |
| 47693-05 | 199  | 47722-10 | 215  | 47740-15 | 245  | 47740-69 | 240  | 47740121 | 242  | 47742-20 | 235  | 47745-05 | 233  |
| 47693-10 | 199  | 47723-05 | 215  | 47740-16 | 241  | 47740-70 | 240  | 47740122 | 242  | 47742-21 | 235  | 47745-06 | 232  |
| 47693-15 | 199  | 47723-06 | 215  | 47740-17 | 242  | 47740-71 | 245  | 47740123 | 242  | 47742-23 | 235  | 47745-07 | 232  |
| 47694-03 | 195  | 47723-07 | 215  | 47740-18 | 240  | 47740-72 | 245  | 47740124 | 242  | 47742-24 | 236  | 47745-08 | 232  |
| 47698-01 | 197  | 47723-08 | 215  | 47740-19 | 243  | 47740-73 | 248  | 47740125 | 241  | 47742-25 | 235  | 47745-09 | 232  |

| Cod.     | pag. | Cod.     | pag. | Cod.     | pag. | Cod.     | pag. | Cod.     | pag. | Cod.     | pag. | Cod.     | pag. |
|----------|------|----------|------|----------|------|----------|------|----------|------|----------|------|----------|------|
| 47745-10 | 232  | 47770-21 | 237  | 47832-14 | 421  | 47860-63 | 224  | 47862-31 | 225  | 47870-18 | 229  | 48238-00 | 365  |
| 47746-01 | 233  | 47771-28 | 237  | 47832-15 | 421  | 47860-66 | 224  | 47862-32 | 225  | 47870-19 | 229  | 48239-00 | 365  |
| 47746-02 | 233  | 47773-24 | 237  | 47833-04 | 181  | 47860-67 | 224  | 47862-33 | 225  | 47875-11 | 221  | 48240-00 | 365  |
| 47746-03 | 233  | 47773-28 | 237  | 47833-10 | 181  | 47860-68 | 224  | 47862-34 | 225  | 47875-13 | 221  | 48241-14 | 373  |
| 47746-04 | 233  | 47783-01 | 221  | 47837-09 | 181  | 47860-69 | 224  | 47862-35 | 225  | 47875-14 | 221  | 48242-09 | 373  |
| 47747-01 | 215  | 47783-02 | 221  | 47838-00 | 197  | 47860-70 | 224  | 47862-36 | 225  | 47876-11 | 230  | 48244-04 | 373  |
| 47747-03 | 215  | 47783-03 | 221  | 47840-11 | 196  | 47860-71 | 224  | 47862-38 | 225  | 47876-12 | 230  | 48244-07 | 373  |
| 47747-04 | 216  | 47783-04 | 221  | 47841-03 | 197  | 47860-73 | 224  | 47862-39 | 225  | 47876-13 | 230  | 48245-10 | 373  |
| 47747-05 | 216  | 47783-11 | 221  | 47841-04 | 197  | 47860-74 | 224  | 47862-64 | 226  | 47876-14 | 230  | 48245-75 | 373  |
| 47747-06 | 215  | 47783-12 | 221  | 47842-00 | 198  | 47860-75 | 225  | 47862-65 | 226  | 47876-15 | 230  | 48247-10 | 372  |
| 47747-07 | 216  | 47783-13 | 221  | 47843-00 | 128  | 47860-76 | 228  | 47862-66 | 226  | 47876-16 | 230  | 48249-13 | 372  |
| 47747-09 | 216  | 47783-14 | 221  | 47843-05 | 128  | 47860-77 | 228  | 47862-67 | 226  | 47876-17 | 230  | 48250-10 | 372  |
| 47747-10 | 215  | 47793-11 | 231  | 47844-01 | 196  | 47860-78 | 228  | 47862-70 | 227  | 47876-18 | 230  | 48250-12 | 372  |
| 47747-11 | 215  | 47793-12 | 231  | 47844-02 | 196  | 47860-81 | 225  | 47862-71 | 227  | 47885-01 | 121  | 48251-03 | 372  |
| 47748-35 | 216  | 47793-13 | 231  | 47844-06 | 196  | 47860-83 | 225  | 47862-72 | 227  | 47885-02 | 121  | 48252-10 | 372  |
| 47749-35 | 217  | 47793-15 | 231  | 47846-10 | 196  | 47860-84 | 225  | 47862-73 | 227  | 47885-03 | 121  | 48252B10 | 372  |
| 47750-06 | 216  | 47793-16 | 231  | 47847-10 | 196  | 47860-85 | 225  | 47862-74 | 227  | 47885-04 | 121  | 48252-12 | 372  |
| 47751-23 | 212  | 47793-18 | 231  | 47847-12 | 196  | 47860-86 | 228  | 47862-75 | 227  | 47885-05 | 122  | 48252B12 | 372  |
| 47752-09 | 214  | 47793-20 | 231  | 47847-23 | 196  | 47860-90 | 229  | 47862-76 | 227  | 48017-14 | 152  | 48253-09 | 372  |
| 47752-16 | 214  | 47793-23 | 231  | 47848-07 | 196  | 47860-91 | 229  | 47862-77 | 227  | 48017-25 | 152  | 48253B09 | 372  |
| 47752-21 | 214  | 47793-26 | 231  | 47859-01 | 284  | 47860-92 | 229  | 47862-80 | 230  | 48021-21 | 152  | 48278-01 | 90   |
| 47753-31 | 214  | 47793-32 | 231  | 47859-02 | 284  | 47860-93 | 229  | 47862-81 | 230  | 48032-30 | 160  | 48278-02 | 90   |
| 47754-20 | 217  | 47793-33 | 231  | 47859-03 | 284  | 47860-94 | 229  | 47862-82 | 230  | 48032-45 | 160  | 48278-03 | 91   |
| 47754-24 | 217  | 47793-40 | 231  | 47860-17 | 222  | 47860-95 | 225  | 47862-83 | 230  | 48032-60 | 160  | 48278-11 | 92   |
| 47754-26 | 217  | 47793-43 | 231  | 47860-18 | 223  | 47860-96 | 225  | 47862-84 | 230  | 48039-06 | 160  | 48278-12 | 89   |
| 47754-28 | 217  | 47793-45 | 231  | 47860-21 | 223  | 47861-02 | 222  | 47862-85 | 230  | 48040-00 | 160  | 48278-13 | 89   |
| 47755-26 | 217  | 47793-52 | 231  | 47860-24 | 223  | 47861-03 | 222  | 47862-86 | 230  | 48040-10 | 160  | 48278-14 | 94   |
| 47756-20 | 217  | 47793-55 | 231  | 47860-27 | 223  | 47861-04 | 222  | 47862-87 | 230  | 48040-50 | 160  | 48278-15 | 92   |
| 47756-24 | 217  | 47800-22 | 195  | 47860-31 | 223  | 47861-05 | 222  | 47862-88 | 230  | 48040-AA | 160  | 48278-16 | 91   |
| 47756-26 | 217  | 47801-20 | 195  | 47860-35 | 223  | 47861-06 | 222  | 47862-89 | 230  | 48210-00 | 365  | 48278-17 | 91   |
| 47756-28 | 217  | 47820-05 | 200  | 47860-36 | 223  | 47861-07 | 222  | 47863-01 | 228  | 48211-00 | 365  | 48278-18 | 94   |
| 47757-65 | 215  | 47820-07 | 200  | 47860-37 | 223  | 47861-08 | 222  | 47863-02 | 228  | 48215-14 | 153  | 48278-19 | 94   |
| 47757-80 | 215  | 47821-05 | 200  | 47860-38 | 223  | 47861-09 | 222  | 47863-03 | 228  | 48215-30 | 153  | 48278-20 | 90   |
| 47758-10 | 213  | 47821-07 | 200  | 47860-39 | 223  | 47861-10 | 222  | 47863-04 | 228  | 48218-00 | 115  | 48278-21 | 90   |
| 47758-12 | 213  | 47822-05 | 200  | 47860-40 | 223  | 47861-11 | 222  | 47865-23 | 230  | 48220-00 | 124  | 48278-24 | 88   |
| 47759-12 | 214  | 47822-07 | 200  | 47860-42 | 223  | 47861-12 | 222  | 47865-44 | 230  | 48222-01 | 124  | 48278-25 | 91   |
| 47760-12 | 214  | 47830-05 | 200  | 47860-43 | 223  | 47861-13 | 222  | 47865-66 | 230  | 48223-00 | 330  | 48278-27 | 93   |
| 47761-23 | 216  | 47830-07 | 200  | 47860-44 | 223  | 47861-14 | 222  | 47865-71 | 230  | 48231-40 | 163  | 48278-28 | 94   |
| 47762-23 | 216  | 47831-02 | 106  | 47860-46 | 223  | 47861-15 | 222  | 47865-72 | 230  | 48231-45 | 163  | 48278-31 | 90   |
| 47763-31 | 216  | 47832-00 | 420  | 47860-48 | 223  | 47861-16 | 228  | 47865-73 | 230  | 48231-50 | 163  | 48278-32 | 88   |
| 47764-12 | 217  | 47832-01 | 292  | 47860-49 | 223  | 47862-03 | 226  | 47865-74 | 230  | 48232-40 | 531  | 48278-33 | 88   |
| 47764-28 | 217  | 47832-02 | 420  | 47860-50 | 223  | 47862-04 | 226  | 47865-75 | 230  | 48232-45 | 531  | 48278-34 | 91   |
| 47765-24 | 236  | 47832-03 | 292  | 47860-53 | 224  | 47862-05 | 226  | 47865-76 | 230  | 48232-50 | 531  | 48278-35 | 91   |
| 47765-26 | 236  | 47832-04 | 292  | 47860-55 | 224  | 47862-06 | 227  | 47865-77 | 230  | 48236-00 | 359  | 48278-36 | 92   |
| 47765-28 | 236  | 47832-05 | 292  | 47860-56 | 224  | 47862-07 | 227  | 47865-80 | 230  | 48236-01 | 359  | 48278-37 | 90   |
| 47766-26 | 236  | 47832-10 | 421  | 47860-58 | 224  | 47862-08 | 227  | 47865-81 | 230  | 48237-00 | 359  | 48278-38 | 89   |
| 47766-28 | 236  | 47832-11 | 421  | 47860-60 | 224  | 47862-09 | 227  | 47865-82 | 230  | 48237-01 | 359  | 48278-39 | 88   |
| 47766-30 | 236  | 47832-12 | 421  | 47860-61 | 224  | 47862-10 | 227  | 47865-83 | 230  | 48237-35 | 359  | 48278-41 | 89   |
| 47769-28 | 237  | 47832-13 | 421  | 47860-62 | 224  | 47862C10 | 227  | 47870-17 | 229  | 48237-99 | 359  | 48278-42 | 89   |



**NUMERICAL INDEX INDICE NUMERICO NUMERISCH INDEX INDEX NUMERIQUE INDICE NUMERICO**

| Cod.     | pag. | Cod.     | pag. | Cod.     | pag. | Cod.     | pag. | Cod.     | pag. | Cod.     | pag. | Cod.     | pag. |
|----------|------|----------|------|----------|------|----------|------|----------|------|----------|------|----------|------|
| 48278-45 | 90   | 48280-15 | 87   | 48286-62 | 117  | 48362-01 | 331  | 48520-30 | 169  | 49336-00 | 480  | 49605-61 | 265  |
| 48278-46 | 89   | 48280-20 | 84   | 48286-64 | 117  | 48363-01 | 331  | 48522-24 | 169  | 49336-02 | 480  | 49605-71 | 265  |
| 48278-47 | 91   | 48280-21 | 84   | 48286-67 | 86   | 48364-09 | 331  | 48523-01 | 168  | 49337-00 | 480  | 49606-00 | 267  |
| 48278-48 | 89   | 48280-22 | 85   | 48286-68 | 365  | 48364-12 | 331  | 48523-02 | 168  | 49337-01 | 480  | 49606-01 | 267  |
| 48278-49 | 89   | 48280-23 | 88   | 48286-70 | 119  | 48365-09 | 297  | 48523-03 | 168  | 49371-09 | 487  | 49606-51 | 267  |
| 48278-52 | 91   | 48280-24 | 86   | 48287-18 | 372  | 48366-09 | 297  | 48523-04 | 168  | 49371-12 | 487  | 49607-15 | 269  |
| 48278-53 | 91   | 48280-25 | 88   | 48287-19 | 372  | 48367-10 | 296  | 48524-75 | 169  | 49373-01 | 466  | 49607-20 | 269  |
| 48278-54 | 91   | 48280-26 | 86   | 48288-02 | 116  | 48368-05 | 341  | 48525-03 | 169  | 49373-02 | 466  | 49607-25 | 269  |
| 48278-55 | 89   | 48280-27 | 158  | 48288-03 | 116  | 48368-12 | 341  | 48526-44 | 169  | 49373-03 | 466  | 49607-30 | 269  |
| 48278-61 | 93   | 48280-30 | 86   | 48289-10 | 115  | 48368-20 | 341  | 48527-00 | 169  | 49373-04 | 466  | 49608-15 | 269  |
| 48278-62 | 93   | 48280-31 | 86   | 48290-10 | 255  | 48369-08 | 341  | 48528-00 | 169  | 49373-05 | 487  | 49608-20 | 269  |
| 48278-63 | 93   | 48280-32 | 84   | 48294-01 | 122  | 48369-14 | 341  | 48529-00 | 169  | 49373-11 | 466  | 49608-25 | 269  |
| 48278-64 | 92   | 48280-34 | 87   | 48294-02 | 122  | 48369-20 | 341  | 48543-01 | 325  | 49373-12 | 466  | 49608-30 | 269  |
| 48278-65 | 93   | 48280-35 | 86   | 48294-03 | 122  | 48370-10 | 297  | 48543-02 | 325  | 49373-13 | 466  | 49608-35 | 269  |
| 48278-66 | 92   | 48280-36 | 86   | 48294-04 | 122  | 48370-11 | 297  | 48550-00 | 489  | 49373-14 | 466  | 49609-12 | 269  |
| 48278-68 | 92   | 48280-37 | 85   | 48295-10 | 118  | 48371-10 | 296  | 48551-00 | 489  | 49373-90 | 466  | 49609-14 | 269  |
| 48278-69 | 92   | 48280-38 | 84   | 48300-29 | 262  | 48371-11 | 296  | 48601-05 | 489  | 49378-00 | 478  | 49610-11 | 269  |
| 48278-71 | 93   | 48280-39 | 84   | 48300-33 | 262  | 48372-08 | 341  | 48610-50 | 484  | 49378-48 | 487  | 49610-14 | 269  |
| 48278-73 | 93   | 48280-41 | 85   | 48300-42 | 262  | 48373-06 | 296  | 48701-08 | 494  | 49379-00 | 478  | 49612-30 | 265  |
| 48278-74 | 93   | 48280-45 | 84   | 48300-43 | 262  | 48373-09 | 296  | 48701-12 | 494  | 49381-01 | 466  | 49612-33 | 265  |
| 48278-75 | 90   | 48280-46 | 85   | 48306-01 | 331  | 48373-12 | 296  | 48710-01 | 492  | 49381-02 | 466  | 49613-30 | 265  |
| 48278-76 | 93   | 48280-47 | 87   | 48307-01 | 161  | 48373-17 | 296  | 48710-02 | 492  | 49381-03 | 466  | 49613-33 | 265  |
| 48278-77 | 90   | 48280-48 | 84   | 48307-02 | 161  | 48501-76 | 167  | 48710-03 | 492  | 49382-10 | 466  | 49613-35 | 265  |
| 48278-81 | 94   | 48280-49 | 85   | 48307-03 | 161  | 48505-01 | 167  | 48710-04 | 492  | 49382-23 | 466  | 49614-28 | 267  |
| 48278-82 | 94   | 48280-52 | 87   | 48310-14 | 308  | 48505-02 | 167  | 48710-05 | 492  | 49382-47 | 466  | 49615-01 | 267  |
| 48278-83 | 94   | 48280-53 | 87   | 48310-20 | 308  | 48505-03 | 167  | 48710-06 | 492  | 49384-03 | 466  | 49616B01 | 267  |
| 48278-84 | 94   | 48280-54 | 86   | 48311-20 | 308  | 48506-01 | 167  | 48710-07 | 492  | 49384-04 | 466  | 49616S01 | 267  |
| 48278-85 | 94   | 48280-59 | 85   | 48311-25 | 308  | 48506-02 | 167  | 48710-08 | 492  | 49384-05 | 466  | 49616-22 | 267  |
| 48278-87 | 89   | 48280-60 | 87   | 48312-25 | 308  | 48506-03 | 167  | 48710-09 | 492  | 49384-06 | 466  | 49616-24 | 267  |
| 48278-88 | 94   | 48280-61 | 87   | 48313-14 | 308  | 48510-00 | 167  | 48711-01 | 493  | 49384-07 | 466  | 49616-26 | 267  |
| 48278-89 | 94   | 48280-62 | 87   | 48313-18 | 308  | 48511-02 | 168  | 48711-02 | 493  | 49384-11 | 466  | 49617-23 | 269  |
| 48278-91 | 92   | 48280-63 | 87   | 48313-20 | 308  | 48512-02 | 168  | 48711-03 | 493  | 49384-14 | 466  | 49617-25 | 269  |
| 48278-92 | 92   | 48280-75 | 85   | 48350-01 | 297  | 48513-02 | 168  | 48711-04 | 493  | 49384-15 | 466  | 49617-30 | 269  |
| 48278-93 | 93   | 48280-85 | 87   | 48350-02 | 297  | 48514-00 | 167  | 48711-05 | 493  | 49600-00 | 265  | 49618-12 | 268  |
| 48278-94 | 90   | 48280-90 | 88   | 48350-03 | 297  | 48515-09 | 168  | 48711-06 | 493  | 49601-14 | 268  | 49618-15 | 268  |
| 48278-95 | 91   | 48280-91 | 88   | 48350-04 | 297  | 48515-11 | 168  | 48711-07 | 493  | 49602-25 | 265  | 49618-18 | 268  |
| 48278-96 | 91   | 48280-92 | 88   | 48351-01 | 298  | 48515-12 | 168  | 48711-08 | 493  | 49602-30 | 265  | 49626-00 | 263  |
| 48278-99 | 92   | 48280-94 | 85   | 48351-02 | 298  | 48516-07 | 168  | 48711-09 | 493  | 49602-33 | 265  | 49626-02 | 263  |
| 48280-02 | 86   | 48280-95 | 88   | 48351-03 | 298  | 48516-08 | 168  | 48712-08 | 493  | 49602-35 | 265  | 49627-22 | 262  |
| 48280-03 | 86   | 48280-96 | 87   | 48352-01 | 298  | 48516-09 | 168  | 48712-10 | 493  | 49603-15 | 264  | 49628-00 | 262  |
| 48280-04 | 84   | 48280-97 | 87   | 48352-02 | 298  | 48517-03 | 168  | 48713-08 | 493  | 49603-20 | 264  | 49629-45 | 269  |
| 48280-05 | 84   | 48281-22 | 118  | 48352-03 | 298  | 48518-01 | 168  | 48713-10 | 493  | 49603-25 | 264  | 49630-06 | 503  |
| 48280-06 | 86   | 48281-23 | 118  | 48353-01 | 297  | 48518-02 | 168  | 48713-15 | 493  | 49603-30 | 264  | 49630-08 | 503  |
| 48280-08 | 87   | 48282-21 | 118  | 48354-01 | 297  | 48519-01 | 169  | 48714-19 | 493  | 49603-40 | 264  | 49632-24 | 267  |
| 48280-09 | 85   | 48285-04 | 119  | 48355-01 | 342  | 48519-02 | 169  | 48715-07 | 494  | 49603-50 | 264  | 49632-32 | 267  |
| 48280-10 | 86   | 48285-05 | 119  | 48356-01 | 342  | 48519-03 | 169  | 48716-07 | 494  | 49604-31 | 265  | 49633-22 | 267  |
| 48280-11 | 87   | 48286-03 | 121  | 48357-01 | 342  | 48519-04 | 169  | 49304-06 | 463  | 49604-36 | 265  | 49633-24 | 267  |
| 48280-12 | 85   | 48286-08 | 121  | 48358-01 | 342  | 48520-20 | 169  | 49335-01 | 480  | 49604-41 | 265  | 49634-00 | 269  |
| 48280-13 | 85   | 48286-13 | 121  | 48359-01 | 342  | 48520-23 | 169  | 49335-02 | 480  | 49605-46 | 265  | 49635-00 | 269  |

| Cod.     | pag. | Cod.     | pag. | Cod.     | pag. | Cod.     | pag. | Cod.     | pag. | Cod.     | pag. | Cod.     | pag. |
|----------|------|----------|------|----------|------|----------|------|----------|------|----------|------|----------|------|
| 49636-00 | 155  | 49655-51 | 262  | 49719-00 | 132  | 49814-00 | 126  | 49838-08 | 114  | 49850-71 | 500  | 49884-08 | 130  |
| 49637-00 | 268  | 49655-52 | 261  | 49720-00 | 132  | 49814-01 | 531  | 49838-98 | 114  | 49850-73 | 501  | 49885-02 | 129  |
| 49638-00 | 269  | 49655-53 | 262  | 49721-03 | 132  | 49815-00 | 125  | 49838-AB | 532  | 49850-75 | 501  | 49887-00 | 129  |
| 49652-10 | 265  | 49655-54 | 261  | 49723-00 | 133  | 49817-00 | 115  | 49839-00 | 113  | 49850-76 | 501  | 49887-02 | 129  |
| 49652-12 | 265  | 49655-55 | 261  | 49726-00 | 489  | 49818-00 | 114  | 49842-00 | 114  | 49851-10 | 513  | 49888-10 | 111  |
| 49652-15 | 265  | 49655-56 | 261  | 49729-00 | 131  | 49818-AC | 114  | 49843-00 | 115  | 49854-03 | 444  | 49888-20 | 111  |
| 49652-17 | 265  | 49655-57 | 261  | 49730-00 | 133  | 49818-AD | 114  | 49843-05 | 124  | 49854-06 | 444  | 49889-09 | 109  |
| 49652-20 | 265  | 49655-58 | 261  | 49730-20 | 132  | 49818-AE | 114  | 49844-01 | 123  | 49855-05 | 444  | 49889-12 | 109  |
| 49653-10 | 265  | 49655-60 | 261  | 49731-10 | 133  | 49818-AF | 114  | 49845-01 | 113  | 49855-10 | 445  | 49889-15 | 109  |
| 49653-12 | 265  | 49655-61 | 262  | 49731-99 | 133  | 49819-00 | 114  | 49846-05 | 445  | 49855-15 | 445  | 49892-40 | 488  |
| 49653-15 | 265  | 49655-64 | 266  | 49733-00 | 132  | 49819-01 | 114  | 49846-09 | 445  | 49856-04 | 444  | 49897-09 | 488  |
| 49653-17 | 265  | 49655-66 | 266  | 49734-00 | 132  | 49819-02 | 114  | 49846-15 | 445  | 49858-00 | 329  | 49898-30 | 488  |
| 49653-20 | 265  | 49656-02 | 266  | 49735-00 | 132  | 49820-05 | 113  | 49847-08 | 446  | 49858-01 | 329  | 49899-01 | 487  |
| 49654-15 | 265  | 49656-15 | 264  | 49739-00 | 160  | 49821-08 | 114  | 49847-38 | 445  | 49858-06 | 329  | 49899-91 | 487  |
| 49654-20 | 265  | 49656-16 | 264  | 49741-07 | 520  | 49823-00 | 120  | 49850-03 | 505  | 49858-07 | 329  | 49899-92 | 487  |
| 49654-25 | 265  | 49656-20 | 264  | 49741-15 | 520  | 49823-89 | 120  | 49850-06 | 502  | 49858-AA | 532  | 49899-93 | 487  |
| 49655-02 | 263  | 49657-15 | 266  | 49750-00 | 115  | 49823-99 | 121  | 49850-10 | 502  | 49859-00 | 329  | 49899-94 | 487  |
| 49655-03 | 263  | 49657-20 | 266  | 49752-00 | 119  | 49825-05 | 120  | 49850-11 | 500  | 49860-00 | 330  | 49899-95 | 487  |
| 49655-10 | 263  | 49657-25 | 266  | 49753-06 | 119  | 49827-03 | 121  | 49850-12 | 501  | 49864-03 | 135  | 49899-AA | 533  |
| 49655-16 | 263  | 49658-01 | 262  | 49753-09 | 119  | 49827-77 | 120  | 49850-13 | 500  | 49864-05 | 135  | 49907-01 | 506  |
| 49655-20 | 259  | 49658-02 | 262  | 49755-10 | 119  | 49827-99 | 120  | 49850-14 | 500  | 49864-20 | 135  | 49907-06 | 506  |
| 49655-21 | 259  | 49659-24 | 265  | 49760-00 | 113  | 49829-11 | 119  | 49850-18 | 499  | 49865-06 | 135  | 49907-AA | 506  |
| 49655-22 | 259  | 49659-26 | 265  | 49771-00 | 135  | 49829-BA | 532  | 49850-19 | 499  | 49865-70 | 135  | 49911-19 | 507  |
| 49655-23 | 259  | 49660-09 | 264  | 49772-01 | 135  | 49830-00 | 532  | 49850-20 | 498  | 49867-01 | 126  | 49911-24 | 507  |
| 49655-24 | 259  | 49660-13 | 264  | 49773-05 | 135  | 49830-02 | 532  | 49850-21 | 499  | 49867-02 | 126  | 49911-30 | 507  |
| 49655-25 | 261  | 49661-22 | 264  | 49774-05 | 135  | 49830-60 | 119  | 49850-22 | 499  | 49870-AA | 533  | 49911-35 | 507  |
| 49655-26 | 261  | 49661-24 | 264  | 49775-05 | 136  | 49830-AA | 532  | 49850-23 | 499  | 49871-10 | 520  | 49911-45 | 507  |
| 49655-27 | 262  | 49662-40 | 264  | 49775-10 | 136  | 49830-AB | 532  | 49850-24 | 504  | 49871-20 | 520  | 49916-25 | 507  |
| 49655-28 | 262  | 49662-50 | 264  | 49776-15 | 136  | 49830-AC | 532  | 49850-25 | 504  | 49872-00 | 520  | 49916-35 | 507  |
| 49655-29 | 260  | 49663-22 | 264  | 49776-30 | 136  | 49831-10 | 117  | 49850-26 | 504  | 49875-06 | 160  | 49916-45 | 507  |
| 49655-30 | 262  | 49663-24 | 264  | 49777-50 | 136  | 49832-02 | 117  | 49850-27 | 504  | 49876-03 | 164  | 49916-55 | 507  |
| 49655-31 | 260  | 49664-01 | 263  | 49779-15 | 136  | 49832-10 | 117  | 49850-28 | 504  | 49879-37 | 124  | 49921-00 | 518  |
| 49655-32 | 260  | 49664-02 | 263  | 49779-30 | 136  | 49832-80 | 532  | 49850-29 | 504  | 49879-90 | 533  | 49922-01 | 509  |
| 49655-34 | 259  | 49664-03 | 263  | 49790-09 | 446  | 49832-86 | 532  | 49850-30 | 504  | 49879-91 | 533  | 49922-02 | 509  |
| 49655-35 | 260  | 49664-04 | 263  | 49801-04 | 498  | 49832-88 | 532  | 49850-31 | 504  | 49879-92 | 533  | 49922-03 | 509  |
| 49655-36 | 259  | 49664-05 | 263  | 49801-06 | 498  | 49832-90 | 532  | 49850-33 | 500  | 49879-93 | 533  | 49922-04 | 509  |
| 49655-37 | 259  | 49701-00 | 129  | 49802-04 | 498  | 49832-96 | 532  | 49850-36 | 501  | 49879-94 | 533  | 49922-06 | 509  |
| 49655-38 | 266  | 49702-00 | 129  | 49802-06 | 498  | 49832-98 | 532  | 49850-37 | 502  | 49880-10 | 131  | 49922-08 | 510  |
| 49655-40 | 266  | 49703-00 | 132  | 49803-02 | 498  | 49832-99 | 532  | 49850-39 | 502  | 49880-11 | 131  | 49922-09 | 510  |
| 49655-41 | 259  | 49703-01 | 198  | 49804-11 | 445  | 49833-00 | 415  | 49850-41 | 501  | 49880-12 | 131  | 49922-20 | 510  |
| 49655-42 | 261  | 49705-00 | 128  | 49806-00 | 499  | 49834-00 | 115  | 49850-42 | 502  | 49880-13 | 131  | 49922-21 | 510  |
| 49655-43 | 261  | 49709-03 | 128  | 49807-00 | 506  | 49834-01 | 532  | 49850-43 | 502  | 49880-14 | 131  | 49922-22 | 510  |
| 49655-44 | 259  | 49710-00 | 129  | 49808-00 | 507  | 49834-02 | 532  | 49850-44 | 502  | 49880-15 | 131  | 49922-23 | 510  |
| 49655-45 | 260  | 49711-00 | 130  | 49809-00 | 504  | 49835-00 | 115  | 49850-61 | 500  | 49881-01 | 131  | 49923-00 | 321  |
| 49655-46 | 259  | 49712-00 | 128  | 49811-00 | 126  | 49835-01 | 532  | 49850-63 | 503  | 49881-02 | 131  | 49923-01 | 321  |
| 49655-47 | 259  | 49715-00 | 130  | 49811-01 | 531  | 49835-02 | 532  | 49850-65 | 498  | 49881-11 | 131  | 49923-02 | 321  |
| 49655-48 | 259  | 49716-00 | 130  | 49811-02 | 531  | 49836-00 | 115  | 49850-66 | 498  | 49881-12 | 131  | 49931-00 | 485  |
| 49655-49 | 264  | 49717-00 | 130  | 49812-00 | 126  | 49837-05 | 113  | 49850-69 | 502  | 49881-99 | 131  | 49931A00 | 486  |
| 49655-50 | 264  | 49718-00 | 132  | 49812-01 | 531  | 49837-AA | 532  | 49850-70 | 502  | 49883-00 | 130  | 49931B01 | 486  |

**NUMERICAL INDEX INDICE NUMERICO NUMERISCH INDEX INDEX NUMERIQUE INDICE NUMERICO**

| Cod.     | pag. | Cod.     | pag. | Cod.     | pag. | Cod.     | pag. | Cod. | pag. | Cod. | pag. |
|----------|------|----------|------|----------|------|----------|------|------|------|------|------|
| 49931B02 | 486  | 49963-08 | 491  | 49996-05 | 456  | 66374-00 | 286  |      |      |      |      |
| 49931B03 | 486  | 49963-09 | 491  | 49997-12 | 512  | 66391-00 | 287  |      |      |      |      |
| 49931C04 | 486  | 49963-11 | 491  | 49997-13 | 512  | 67303M01 | 260  |      |      |      |      |
| 49931B05 | 486  | 49963-13 | 491  | 49998-20 | 514  | 67303M02 | 261  |      |      |      |      |
| 49931-60 | 485  | 49963-15 | 491  | 49998-35 | 514  | 67303M03 | 261  |      |      |      |      |
| 49931-64 | 486  | 49963-17 | 491  | 52550F63 | 524  | 67303M04 | 260  |      |      |      |      |
| 49931-87 | 485  | 49963-19 | 491  | 52550F73 | 525  | 67303M05 | 261  |      |      |      |      |
| 49933-30 | 485  | 49963-21 | 491  | 52550F78 | 525  | 67303M06 | 261  |      |      |      |      |
| 49933-50 | 485  | 49971R00 | 164  | 52550F80 | 525  | 67303M07 | 261  |      |      |      |      |
| 49933-68 | 485  | 49971-25 | 164  | 52550F88 | 525  | 67303-64 | 286  |      |      |      |      |
| 49934-04 | 487  | 49971M25 | 164  | 66303-01 | 286  | 67303Q80 | 260  |      |      |      |      |
| 49934-06 | 487  | 49971P25 | 164  | 66303-03 | 286  | 67303Q81 | 260  |      |      |      |      |
| 49934-08 | 487  | 49971R25 | 164  | 66303-06 | 286  | 67303Q82 | 260  |      |      |      |      |
| 49934-14 | 487  | 49972-30 | 164  | 66307-06 | 286  | 67303Q83 | 260  |      |      |      |      |
| 49934-16 | 487  | 49972M30 | 164  | 66307-09 | 286  | 67305-57 | 260  |      |      |      |      |
| 49934-18 | 487  | 49972P30 | 164  | 66307-12 | 286  | 67308-57 | 260  |      |      |      |      |
| 49940-01 | 507  | 49972R30 | 164  | 66313-03 | 286  | XO1046   | 533  |      |      |      |      |
| 49942-01 | 507  | 49974-25 | 519  | 66313-06 | 286  |          |      |      |      |      |      |
| 49942-03 | 508  | 49974U25 | 519  | 66318-19 | 287  |          |      |      |      |      |      |
| 49943-01 | 508  | 49974-30 | 519  | 66318-22 | 287  |          |      |      |      |      |      |
| 49943-02 | 508  | 49974U30 | 519  | 66320-28 | 412  |          |      |      |      |      |      |
| 49944-01 | 508  | 49975-19 | 518  | 66320-35 | 412  |          |      |      |      |      |      |
| 49944-02 | 508  | 49975U19 | 518  | 66320-40 | 412  |          |      |      |      |      |      |
| 49945-05 | 512  | 49975-22 | 518  | 66320-50 | 412  |          |      |      |      |      |      |
| 49946-01 | 508  | 49975U22 | 518  | 66320-65 | 412  |          |      |      |      |      |      |
| 49947-08 | 512  | 49975-25 | 518  | 66320-85 | 412  |          |      |      |      |      |      |
| 49949-09 | 510  | 49975U25 | 518  | 66320-99 | 412  |          |      |      |      |      |      |
| 49949-19 | 503  | 49975-30 | 519  | 66324-40 | 412  |          |      |      |      |      |      |
| 49949-20 | 507  | 49975U30 | 519  | 66324-50 | 412  |          |      |      |      |      |      |
| 49952-08 | 513  | 49975-35 | 519  | 66324-65 | 412  |          |      |      |      |      |      |
| 49953-02 | 503  | 49975U35 | 519  | 66324-85 | 412  |          |      |      |      |      |      |
| 49954-18 | 512  | 49978-10 | 164  | 66324-99 | 412  |          |      |      |      |      |      |
| 49954-20 | 512  | 49978-13 | 164  | 66325-30 | 412  |          |      |      |      |      |      |
| 49954-21 | 511  | 49979-03 | 503  | 66325-35 | 412  |          |      |      |      |      |      |
| 49954-22 | 513  | 49986-00 | 130  | 66325-41 | 412  |          |      |      |      |      |      |
| 49955-01 | 511  | 49987-00 | 130  | 66325-46 | 412  |          |      |      |      |      |      |
| 49956-01 | 511  | 49988-00 | 130  | 66325-54 | 412  |          |      |      |      |      |      |
| 49956-AA | 533  | 49993-01 | 505  | 66325-85 | 412  |          |      |      |      |      |      |
| 49957-00 | 511  | 49993-02 | 505  | 66325-99 | 412  |          |      |      |      |      |      |
| 49958-00 | 510  | 49993-03 | 505  | 66326-30 | 412  |          |      |      |      |      |      |
| 49959-00 | 511  | 49993-11 | 505  | 66326-35 | 412  |          |      |      |      |      |      |
| 49960-00 | 511  | 49993-12 | 505  | 66326-40 | 412  |          |      |      |      |      |      |
| 49961-01 | 490  | 49993-13 | 505  | 66326-60 | 412  |          |      |      |      |      |      |
| 49961-02 | 490  | 49993-21 | 505  | 66326-80 | 412  |          |      |      |      |      |      |
| 49961-10 | 490  | 49993-22 | 505  | 66339-02 | 287  |          |      |      |      |      |      |
| 49963-01 | 490  | 49993-23 | 505  | 66345-55 | 412  |          |      |      |      |      |      |
| 49963-03 | 491  | 49995-04 | 455  | 66345-65 | 412  |          |      |      |      |      |      |
| 49963-04 | 491  | 49996-00 | 456  | 66345-74 | 412  |          |      |      |      |      |      |
| 49963-06 | 491  | 49996-01 | 456  | 66362-02 | 361  |          |      |      |      |      |      |

# SALES CONDITIONS

CONDIZIONI DI VENDITA

LIEFERBEDINGUNGEN

CONDITIONS DE VENTE

CONDICIONES DE VENTA

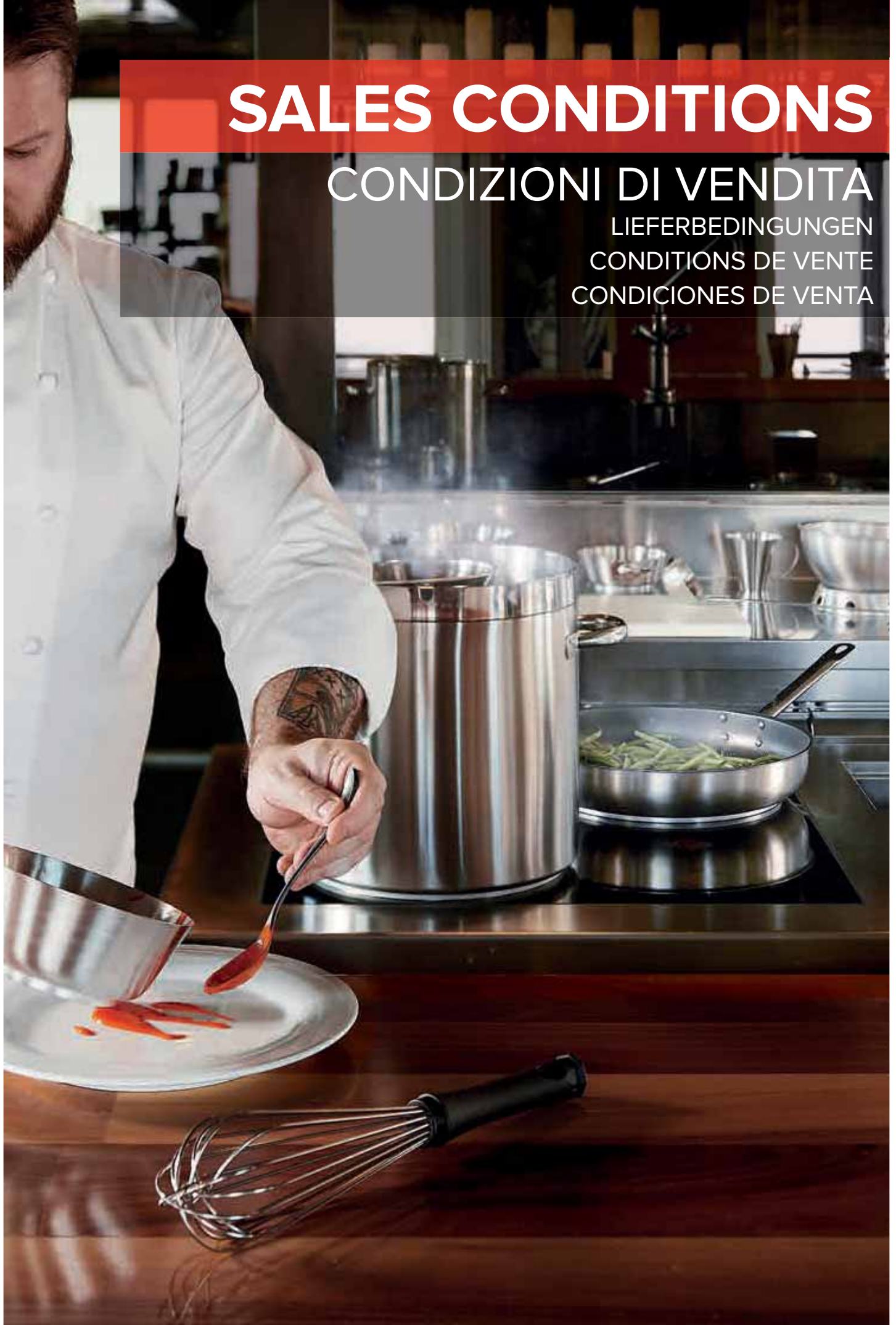

## General Sales Terms & Conditions

- All orders are subject to approval and acceptance by Sambonet Paderno Industrie S.p.A.
- Minimum order € 250,00 net.
- Standard packaging included in the price.
- These general sales terms & conditions may be modified only by an agreement in writing.

## Ownership & Payment Terms

- All goods remain the sole property of the Sambonet Paderno Industrie S.p.A. until payment has been made in full.
- Title to the ownership of any delivered good shall be transferred to the client upon full payment of the price set forth in the invoice. Payment becomes due within the payment term agreed upon by the parties. Should any amount to be paid by the client become overdue, the client shall pay a late payment interest pursuant to art. 5 D.LGS. 231/2002, as subsequently amended pursuant D.LGS. 192/2012, plus an 8% interest rate.

## Offers/Orders

- Any offer of Sambonet Paderno Industrie S.p.A shall not be binding.
- The written acceptance of any offer, or the order confirmation (according to the sales conditions included in it), constitutes a valid purchase order in accordance with the general sales terms & conditions, for all the purposes thereof.

## Returns/Complaints

- Goods must be inspected at the time of delivery.
- Should any good be damaged or defected, the waybill shall be signed with reserve, specifying the relevant reason (pictures of the good displaying the batch number, the courier and a description of the defect must be presented).
- Product returns must be made within 15 days of invoice date, subject to the following conditions:
  - claims and complaints must be made through the guided procedure available on our website, [www.agenti.sambonet.it](http://www.agenti.sambonet.it), under the user section;
  - Goods are delivered ex works - at our premises in Orfengo;
  - In case of customer liability, Sambonet Paderno Industrie S.p.A. will charge 15% of the net value of the goods, with a minimum of € 25.00 for handling charges;
  - In case goods are returned due to our fault, Sambonet Paderno Industrie S.p.A. will replace them free of charge;
  - client will be responsible for all shipping costs for products purchased out of warranty that need to be returned for repairs;
  - customized (not included in our catalogue), Tailor Made engraved, with extra personalization and discontinued items cannot be returned.

## Order Cancellation

- Cancellation is not allowed in case of discontinued, custom designed, and non-stock items.
- Catalogue items can be cancelled only if the purchase order has not yet been confirmed.

## Delivery Terms in the following EU Countries:

### Belgium, Netherlands, Luxembourg, France, Spain, Germany

- Goods are delivered **ex works** for orders having a net invoice value under € 500,00;
- Goods are **delivered at client's place**:
  - with a charge of € 60,00 for orders with a net value between € 500,00 and € 1,000,00;
  - free of charge for orders with a net value over € 1,000,00.
- Above delivery terms are valid only for shipments executed through our fixed forwarding agent.

### Delivery Terms in other EU Countries (islands excluded):

- Goods are delivered ex works for orders having an invoice value under € 500,00;
- Goods are delivered at client's place:
  - with a charge of € 60,00 for orders with net value between € 500,00 and € 1,500,00;
  - free of charge for orders with a net value over € 1,500,00.
- Above delivery terms are valid only for shipments executed through our fixed forwarding agent.

### Delivery Terms for Extra EU Countries (islands excluded):

- Goods are delivered ex works.

## Personalisations (The costs indicated are net)

- Sambonet Paderno Industrie S.p.A. makes customizations and special executions at the customer's request under the following conditions:
  - advance payment of 30%** on the value of the order;
  - delivery to be agreed after approval of the executive design and/or the sample;
  - Sambonet Paderno Industrie S.p.A. reserves the right to apply a **tolerance** in quantity of +/- 10% (rounded up) for each item ordered;
  - Sambonet Paderno Industrie S.p.A. shall provide the Customer with a form indicating all the necessary parameters (design, position, dimensions, etc.) and shall proceed with the supply only upon receipt of the same signed for acceptance.
- Sawing of fruit knife blades: if not standard, € 0.65 per piece will be charged.
- Pantograph/Laser engraving:
  - plant cost: € 70,00;
  - engraving cost: cutlery € 0.50 per piece – holloware € 1.00 per piece.
  - minimum quantities: cutlery 100 pcs – holloware 10 pcs.
- Stamping:
  - die costs: € 300,00 for the first die - additional dies € 150,00 each;
  - stamping costs: cutlery € 0.50 per piece - holloware will be quoted upon request;
  - minimum quantities:
    - first order: cutlery 1,000 pieces per item - hollow handle knives 800 pieces per item;
    - for further orders: cutlery 100 pieces per item - hollow handle knives 800 pieces per item.

## Sambonet Tailor Made personalizations (The costs indicated are net)

- Type of standard Tailor Made engravings:
  - On the front terminal: one of the standard logos, or the monogram (two letters) using one of the standard characters;
  - On the rear terminal: the date in the standard format, using one of the standard characters;
- Tailor Made engraving cost:
  - € 19.90 for engravings on the front terminal;
  - € 19.90 for engravings on the rear terminal;
  - € 39.80 for engraving on both the front and rear terminals.
- Minimum purchase order for Tailor Made loose items:
  - 6 pcs for nickel-silver items, multiples of 6 pcs;
  - 12 pcs for all other items, multiples of 12 pcs.
- Application of the Tailor Made engraving cost on the single purchase order:
  - A single cost per type of engraving, as set out in point 2;
  - A single cost regardless of the number of pcs, if higher than the minimum purchase indicated in point 3;
  - One cost regardless of the number of pcs up to 150 pcs.
  - Above 150 pcs and at multiples of 150 pcs the cost of engraving will be applied again.

## Special conditions for personalisations

- The Company reserves the right not to carry out the customization if it considers it not technically executable.
- Customized orders and special executions cannot be cancelled.
- Customized products cannot be returned for replacement.
- Requests for specific packaging will be charged to the Customer.

## Marketing

- The goods are intended for marketing in the Country where the customer is based. If the goods are sold in a different Country, the client shall undertake to verify the regulations applicable to the goods in such Country, including customs and import rules, as well as the risk of disputes by third parties for an reason whatsoever. It being understood that the client shall hold Sambonet Paderno Industrie S.p.A. harmless of any claim and/or legal action from third parties arising by the sale of the goods in such different Country.
- Sambonet Paderno Industrie S.p.A. does not provide any guarantee regarding possible infringement of intellectual property rights of third parties, in particular in the event of resale of the goods over the internet.
- It is prohibited to publish prices lower than the price lists in force on websites without authentication.

## Retention of title and payment terms

- Any complaints shall not in any case have the effect of deferring or suspending payments.
- Any payment delays shall therefore render the Customer a debtor by law to Sambonet Paderno Industrie S.p.A. of a lump sum indemnity for reminder costs of € 40,00. If the reminder costs exceed the aforementioned amount, Sambonet Paderno Industrie S.p.A. will have the right to claim a further indemnity.
- In the event of non-payment of all or part of the invoice, or of any deterioration in the Customer's financial situation, Sambonet Paderno Industrie S.p.A. will also have the right to:
  - suspend or cancel the orders and deliveries in progress;
  - request advance payment for further orders and/or payment guarantees.

## Delivery

- The delivery deadlines are indicated as accurately as possible but they depend upon the procurement and transportation conditions of Sambonet Paderno Industrie S.p.A., which undertakes to apply the utmost diligence in order to respect the deliveries, subject to causes of force majeure.
- If the planned delivery deadlines are exceeded, Sambonet Paderno Industrie S.p.A. shall not be required to pay any penalty, damages compensation or interest.
- Any change to the order will lead to a consequent change to the delivery date.
- The following are considered to be causes of force majeure, which release Sambonet Paderno Industrie S.p.A. from the delivery obligation: war, revolt, fire, strikes, impossibility of procurement, particularly significant incidents involving equipment, machine breakdowns, interruption or delay in transportation.
- Sambonet Paderno Industrie S.p.A. will keep the Customer informed of any delay. In any case, the delivery within the deadlines may only be made if the Customer has precisely fulfilled all its obligations towards Sambonet Paderno Industrie S.p.A., whatever the cause.
- It is, moreover, agreed between the parties that if the Customer does not take possession of the ordered products under the established conditions, Sambonet Paderno Industrie S.p.A. will invoice to the Customer:
  - any additional transportation and/or storage cost;
  - custody costs equivalent to 5% of the order amount, excluding taxes, for each month of delay.

## Important notice

- Considering that different operations are processed manually, some slight differences between same products of different lots may be noticed.
- Products undergone PVD processing may be subject to slight colour and shade variations between different models or between different references. These variations are not to be considered as defects as they are within the established tolerance limits and they are closely monitored.
- Errors may occur during the printing stage. Sambonet Paderno Industrie S.p.A. reserves the right to correct printing or calculation errors.
- The pictures illustrated and data are representatives. Sambonet Paderno Industrie S.p.A. reserves the right to alter at any time the specifications stated without notice.
- The shapes of cutlery illustrated in this publication are representatives and are not to be considered as the real shape.

## COPYRIGHT

© This catalogue may not be reproduced in whole or in part unless specific prior written authorization of Sambonet Paderno Industrie S.p.A.

## ITA

### Condizioni Generali e Termini di Vendita

1. Gli ordini sono soggetti ad approvazione di Sambonet Paderno Industrie S.p.A.
2. Ordine minimo € 250,00 netto merce.
3. Imballo standard gratuito.
4. Qualsiasi variazione delle presenti condizioni richiede la forma scritta.

### Diritto di Proprietà e Condizioni di Pagamento

1. La merce fornita rimane di proprietà di Sambonet Paderno Industrie S.p.A. fino all'integrale pagamento della fattura da parte del cliente.
2. Il pagamento della fattura è dovuto entro il termine di pagamento preventivamente concordato tra le parti. Allo scadere di tale termine, saranno dovuti gli interessi di mora al saggio di cui all'art.5 D.LGS. 231/2002 e succ. modifiche come da D.LGS. 192/2012, maggiorato dell'8%.

### Offerte/Ordini

1. Le offerte di Sambonet Paderno Industrie S.p.A. sono libere e non vincolanti all'ordine.
2. Con l'accettazione dell'offerta in forma scritta o della conferma d'ordine (con le modalità in essa contenute), si genera a tutti gli effetti un ordine che comporta l'esecuzione di un contratto conforme alle condizioni generali e termini di vendita.

### Resi/Reclami

1. La merce deve essere controllata al ricevimento.
2. In caso di colli difettosi/danneggiati, il documento di trasporto dovrà essere firmato con riserva, specificando i motivi (vale come prova la foto del collo con evidenza del segnacollo e nastro del corriere e descrizione del difetto).
3. I reclami saranno accettati entro **15 giorni** dalla data fattura, termine ultimo non negoziabile, alle seguenti condizioni:
  - a) la segnalazione di reclamo / richiesta di reso merce deve essere fatta attraverso la procedura guidata all'indirizzo [www.agenti.sambonet.it](http://www.agenti.sambonet.it) nell'area utente;
  - b) la merce dovrà essere resa franco nostra fabbrica;
  - c) In caso di responsabilità del cliente, Sambonet Paderno Industrie S.p.A. provvederà all'addebito del 15% del prezzo netto, con un minimo di € 25,00, per costi di gestione;
  - d) in caso di accertata responsabilità di Sambonet Paderno Industrie S.p.A., la merce verrà sostituita, e resa franco domicilio cliente;
  - e) per prodotti resi per riparazione non in garanzia, le spese di spedizione e rispedizione, sono a carico del cliente;
  - f) Non saranno accettati resi per articoli speciali (non a catalogo), incisi Tailor Made, con altre personalizzazioni o fuori produzione.

### Annullamento dell'ordine

1. Per i prodotti fuori catalogo, personalizzati o speciali NON è possibile annullare l'ordine.
2. Per i prodotti a catalogo, l'annullamento è possibile solo se l'ordine non è ancora stato confermato.

### Condizioni di Resa Italia

1. La merce è resa franco domicilio Cliente tramite corriere convenzionato con Sambonet Paderno Industrie S.p.A.:
  - a) con addebito forfettario di € 15,00 (spese di gestione ordine) per ordini da € 250,00 a € 500,00 netto merce;
  - b) senza alcun addebito per ordini superiori a € 500,00 netto merce.
2. Qualora il Cliente richieda che le spedizioni vengano effettuate tramite Suo corriere di fiducia, le merci verranno inoltrate automaticamente in **franco fabbrica**:
  - a) con addebito forfettario di € 15,00 (spese di gestione ordine) per ordini da € 250,00 a € 500,00 netto merce;
  - b) senza alcun addebito per ordini superiori a € 500,00 netto merce.
3. Per ogni contestazione o controversia è applicabile la legge Italiana e competente il Foro di Novara.

### Condizioni di Resa nei seguenti Paesi UE (isole escluse):

**Belgio, Olanda, Lussemburgo, Francia, Spagna, Germania**

1. La merce è resa **franco fabbrica** per ordini inferiori a € 500,00;
2. La merce è resa **franco domicilio Cliente**:
  - a) con addebito di € 60,00 per ordini da € 500,00 a € 1.000,00 netto merce;
  - b) senza alcun addebito per ordini superiori a € 1.000,00 netto merce.
3. Le condizioni sopra indicate sono valide solo per spedizioni tramite corriere convenzionato con Sambonet Paderno Industrie S.p.A.

### Condizioni di Resa nei restanti Paesi UE (isole escluse):

1. La merce è resa franco fabbrica per ordini inferiori a € 500,00;
2. La merce è resa franco domicilio Cliente:
  - a) con addebito di € 60,00 per ordini da € 500,00 a € 1.500,00 netto merce;
  - b) senza alcun addebito per ordini superiori a € 1.500,00 netto merce.
3. Le condizioni sopra indicate sono valide solo per spedizioni tramite corriere convenzionato con Sambonet Paderno Industrie S.p.A.

### Condizioni di Resa Paesi extra-UE

1. La merce è resa franco fabbrica.

### Personalizzazioni (I costi indicati sono da intendersi netti)

1. Sambonet Paderno Industrie S.p.A. effettua su richiesta del Cliente personalizzazioni ed esecuzioni particolari alle seguenti condizioni:
  - a) versamento di **acconto del 30%** sul valore dell'ordine;
  - b) consegna da convenire dopo l'approvazione disegno esecutivo e/o campione;
  - c) Sambonet Paderno Industrie S.p.A. si riserva la facoltà di applicare, per ogni singolo articolo, una **tolleranza pari a +/- 10%**, con arrotondamento all'unità superiore, nella spedizione dei quantitativi ordinati;
  - d) Sambonet Paderno Industrie S.p.A. provvederà a fornire al Cliente una scheda con l'indicazione di tutti i parametri necessari (disegno, posizione, dimensioni, ecc.) e procederà alla fornitura solo al ricevimento della stessa firmata per accettazione.
2. Seghettatura lame coltelli frutta: ove non prevista di serie, con addebito di € 0,65 al pezzo.
3. Incisione al Pantografo/Laser:
  - a) costo impianto: € 70,00;
  - b) costo incisione: posateria € 0,50 al pezzo - vasellame, incisione ove possibile, € 1,00 al pezzo;
  - c) quantità minime: posateria 100 pezzi per articolo - vasellame 10 pezzi per articolo.
4. Punzonatura:
  - a) costo punzoni: il primo punzone € 300,00 - i successivi € 150,00 cad.;
  - b) costo punzonatura: posateria € 0,50 al pezzo - vasellame preventivo su richiesta;
  - c) quantità minime:
    - nuovi impianti: posateria 1.000 pezzi per articolo - coltelli manico cavo 800 pezzi per articolo;
    - riordini: posateria 100 pezzi per articolo - coltelli manico cavo 800 pezzi per articolo.

### Personalizzazioni Sambonet Tailor Made (I costi indicati sono da intendersi netti)

1. Tipologia di incisioni Tailor Made standard:
  - a) Sul terminale frontale: uno dei loghi standard, oppure il monogramma (due lettere) utilizzando uno dei caratteri standard;
  - b) Sul terminale posteriore: la data in formato standard, utilizzando uno dei caratteri standard;
2. Costo di incisione Tailor Made:
  - a) € 19,90 per incisioni sul terminale frontale;
  - b) € 19,90 per incisioni sul terminale posteriore;
  - c) € 39,80 per incisioni sul terminale frontale e sul terminale posteriore.
3. Ordine minimo di acquisto per articoli sfusi Tailor Made:
  - a) 6 pz per le referenze realizzate in alpaca, a multipli di 6 pz;
  - b) 12 pz per tutte le altre referenze, a multipli di 12 pz;
4. Applicazione del costo di incisione Tailor Made sul singolo ordine di acquisto:
  - a) Un solo costo per ogni tipologia di incisione - indicate al punto 2;
  - b) Un solo costo a prescindere dal numero di referenze - se superiori al minimo di acquisto indicato al punto 3;
  - c) Un solo costo a prescindere dal numero di pz fino a 150 pz.
  - d) Oltre i 150 pz e a multipli di 150 pz verrà nuovamente applicato il costo di incisione.

### Condizioni speciali per le personalizzazioni

1. L'Azienda si riserva il diritto di non eseguire la personalizzazione qualora tecnicamente non eseguibile.
2. Ordini personalizzati e/o esecuzioni particolari non possono essere annullati.
3. I prodotti personalizzati non possono essere resi per sostituzione.
4. Le richieste di imballaggi specifici saranno a carico del Cliente.

### Commercializzazione

1. La merce è destinata alla commercializzazione nel Paese in cui ha sede il Cliente. Qualora la merce sia commercializzata in un Paese differente, sarà onere del Cliente verificare le normative applicabili in tale Paese incluse le normative doganali e di importazione, nonché il rischio di contestazioni da parte di terzi a qualunque titolo, restando inteso che Sambonet Paderno Industrie S.p.A. sarà manlevata e tenuta indenne dal Cliente per quanto causato dalla vendita della merce in tale diverso Paese.
2. Sambonet Paderno Industrie S.p.A. non fornisce alcuna garanzia in ordine a possibili contestazioni di violazione di diritti di proprietà industriale ed intellettuale di terzi, in particolare nell'ipotesi di rivendita della merce a mezzo Internet.
3. È vietato pubblicare prezzi inferiori ai listini vigenti in siti web senza autenticazione.

### Riserva di proprietà e condizioni di pagamento

1. Eventuali reclami non potranno in alcun caso avere come effetto il differimento o la sospensione dei pagamenti.
2. Il Cliente in situazioni di ritardo di pagamento sarà peraltro debitore di diritto, nei confronti di Sambonet Paderno Industrie S.p.A. di un indennizzo forfettario per spese di sollecito pari a € 40,00. Qualora le spese di sollecito siano superiori al suddetto importo, Sambonet Paderno Industrie S.p.A. avrà il diritto di richiedere un ulteriore indennizzo.
3. In caso di mancato pagamento di tutta o parte della fattura, o di aggravio della situazione finanziaria del Cliente, Sambonet Paderno Industrie S.p.A. avrà anche la facoltà di:
  - a) sospendere o annullare gli ordini e le consegne in corso;
  - b) esigere un pagamento anticipato per gli ulteriori ordini e/o garanzie di pagamento.

### Consegna

1. Le scadenze di consegna sono indicate il più esattamente possibile, ma dipendono dalle condizioni di approvvigionamento e trasporto di Sambonet Paderno Industrie S.p.A., la quale si impegna a porre la massima diligenza ai fini del rispetto delle consegne salvo cause di forza maggiore.
2. Il superamento dei tempi di consegna previsti, non potrà vincolare Sambonet Paderno Industrie S.p.A. al versamento di penalità, risarcimenti per danni e interessi.
3. Qualsiasi modifica di ordine darà luogo a una conseguente modifica della data di consegna.
4. Sono considerate come cause di forza maggiore, che svincolano Sambonet Paderno Industrie S.p.A. dall'obbligo di consegna: guerra, rivolta, incendio, scioperi, impossibilità di approvvigionamento, incidenti particolarmente rilevanti all'attrezzatura, la rottura di macchine, l'interruzione o il ritardo nel trasporto.
5. Sambonet Paderno Industrie S.p.A. terrà il Cliente tempestivamente informato di qualsiasi ritardo. In ogni caso, la consegna entro i termini potrà essere effettuata soltanto se il Cliente avrà puntualmente ottemperato a tutti i suoi obblighi nei confronti di Sambonet Paderno Industrie S.p.A., qualsiasi sia la causa.
6. Viene peraltro convenuto tra le parti che se il Cliente non prenderà possesso dei prodotti ordinati alle condizioni stabilite, Sambonet Paderno Industrie S.p.A. fatturerà al Cliente:
  - a) qualsiasi ulteriore spesa di trasporto e/o giacenza;
  - b) spese di custodia equivalenti al 5% dell'importo dell'ordine, tasse escluse, per ogni mese di ritardo.

### Avvertenze importanti

1. In considerazione del fatto che la produzione è artigianale, potrebbero rilevarsi lievi differenze tra partite diverse dello stesso prodotto.
2. I prodotti sottoposti a lavorazione PVD potrebbero essere soggetti a leggere variazioni cromatiche e di tonalità tra diversi modelli o tra le diverse referenze. Tali variazioni non sono da considerarsi difetti poiché compresi entro limiti di tolleranza prestabiliti e strettamente monitorati.
3. In fase di stampa sono possibili errori e/o omissioni. Sambonet Paderno Industrie S.p.A. si riserva il diritto di rettifica di eventuali errori di stampa o calcolo.
4. Le immagini, le caratteristiche e le misure espresse sono indicative e soggette a variazioni senza preavviso.
5. Le sagome delle posate illustrate di questa pubblicazione sono puramente indicative e non si riferiscono alle sagome reali.

### COPYRIGHT

© Ogni riproduzione anche parziale del presente catalogo è vietata se non espressamente autorizzata per iscritto da Sambonet Paderno Industrie S.p.A.

## Allgemeine Verkaufsbedingungen

- Bestellungen sind erst nach Bestätigung durch Sambonet Paderno Industrie S.p.A. gültig.
- Mindestwarenbestellwert € 250,00 netto.**
- Standardverpackung kostenlos.
- Änderungen dieser Bedingungen bedürfen der Schriftform.

## Eigentumsrecht und Zahlungsbedingungen

- Die gelieferte Ware bleibt bis zur vollständigen Bezahlung der Rechnung durch den Kunden Eigentum der Sambonet Paderno Industrie S.p.A.
- Die Bezahlung der Rechnung muss innerhalb der zwischen den Parteien zuvor vereinbarten Zahlungsfrist erfolgen. Nach Ablauf dieser Frist werden Verzugszinsen in der in Art. 5 der [italienischen gesetzesvertretenden Verordnung] D. Lgs. 231/2002 (in der durch D. Lgs. 192/2012 geänderten Fassung) vorgesehenen Höhe zuzüglich 8 % fällig.

## Angebote/Bestellungen

- Angebote von Sambonet Paderno Industrie S.p.A. sind freibleibend.
- Mit der schriftlichen Annahme des Angebots oder der Auftragsbestätigung (mit allen enthaltenen Bedingungen) wird eine in jeder Hinsicht wirksame Bestellung aufgegeben, die mit der Ausführung eines Vertrags gemäß den allgemeinen Verkaufsbedingungen verbunden ist.

## Rückgaben/Reklamationen

- Die Ware ist bei Erhalt zu kontrollieren.
- Sollten Pakete defekt/beschädigt sein, so ist das Transportdokument unter Vorbehalt und mit Angabe der Gründe (z. B. ein Foto der Ware, auf der die Kennzeichnung der Ware und die Spedition erkennbar sind, und eine Beschreibung des Defekts) zu unterschreiben.

Reklamationen werden innerhalb von 15 Tagen nach Rechnungsdatum als letzte nicht verhandelbare Frist unter folgenden Bedingungen angenommen:

- Die Reklamation/der Antrag auf Rücknahme der Ware erfolgt über das angeleitete Verfahren im Benutzerbereich der Website [www.agenti.sambonet.it](http://www.agenti.sambonet.it);
- Die Lieferung erfolgt frei unserem Werk;
- Liegt die Verantwortung für die Rückgabe beim Kunden, Sambonet Paderno Industrie S.p.A. stellt 15% des Nettopreises, jedoch mindestens € 25,00 als Bearbeitungskosten in Rechnung;
- Liegt die Verantwortung nachgewiesenermaßen bei Sambonet Paderno Industrie S.p.A., wird die Ware ersetzt und dem Kunden frei Haus zugestellt;
- Im Falle von Produkten, die zur Reparatur zurückgegeben werden und keiner Gewährleistung unterliegen, gehen die Kosten für Zu- und Rücksendung zu Lasten des Kunden;
- Nicht angenommen werden Rücksendungen von Sonderartikeln (nicht im Katalog), kundenindividuellen Artikeln und Artikeln, deren Produktion eingestellt wurde.

## Stornierung der Bestellung

- Bestellungen von Produkten, die nicht im Katalog enthalten oder die kundenindividuell gefertigt sind, oder Bestellungen von Sonderartikeln können NICHT storniert werden.
- Bei Produkten aus dem Katalog ist eine Stornierung nur möglich, wenn die Bestellung noch nicht bestätigt wurde.

## Lieferbedingungen für die folgenden EU-Länder (Inseln ausgeschlossen):

### Belgien, Niederlande, Luxemburg, Frankreich, Spanien, Deutschland

- Die Lieferung der Ware erfolgt frei Werk bei Bestellungen unter einem Wert von € 500,00.
- Die Lieferung zum Kunden erfolgt frei Haus, wobei:
  - bei einem Warenbestellwert zwischen € 500,00 und € 1.000,00 netto eine Pauschale von € 60,00 in Rechnung gestellt wird;
  - bei einem Warenbestellwert von über € 1.000,00 netto keine Versandkosten in Rechnung gestellt werden.
- Die vorstehenden Bedingungen gelten nur für den Versand mit dem Vertragsspediteur von Sambonet Paderno Industrie S.p.A.

## Lieferbedingungen für die übrigen EU-Länder (Inseln ausgeschlossen)

- Die Lieferung der Ware erfolgt **frei Werk** bei Bestellungen unter einem Wert von € 500,00.
- Die Lieferung **zum Kunden** erfolgt **frei Haus**, wobei:
  - bei einem Warenbestellwert zwischen € 500,00 und € 1.500,00 netto eine Pauschale von € 60,00 in Rechnung gestellt wird;
  - bei einem Warenbestellwert von über € 1.500,00 netto keine Versandkosten in Rechnung gestellt werden.
- Die vorstehenden Bedingungen gelten nur für den Versand mit dem Vertragsspediteur von Sambonet Paderno Industrie S.p.A.

## Lieferbedingungen für Länder außerhalb der EU

- Die Lieferung erfolgt frei Werk.

## Kundenindividuelle Anfertigungen (die angegebenen Kosten verstehen sich als Nettobeträge)

- Auf Wunsch des Kunden stellt Sambonet Paderno Industrie S.p.A. kundenindividuelle und Sonderanfertigungen her. Es gelten die folgenden Bedingungen:
  - Es wird eine **Anzahlung in Höhe von 30 %** des Bestellwertes geleistet;
  - Die Lieferung wird nach der Freigabe der endgültigen Gestaltung und/oder des Musters vereinbart;
  - Sambonet Paderno Industrie S.p.A. behält sich in Bezug auf den Versand der bestellten Mengen für jeden einzelnen Artikel einen **Toleranzwert** von +/- 10 % mit Aufrundung auf die nächsthöhere Einheit vor;
  - Sambonet Paderno Industrie S.p.A. legt dem Kunden ein Beschreibungsblatt mit allen erforderlichen Parametern (Zeichnung, Platzierung, Abmessungen usw.) vor. Die Lieferung erfolgt erst, nachdem der Kunde dieses zum Zeichen der Annahme unterschrieben und zurückgesendet hat.
- Wellenschliff Obstmesser, wenn nicht serienmäßig vorgesehen, Aufpreis von € 0,65 pro Stück.
- Gravur mit Pantograf/Laser
  - Einrichtungskosten: € 70,00;
  - Gravurkosten: Besteck € 0,50 pro Stück – Geschirr, sofern Gravur möglich, € 1,00 pro Stück;
  - Mindestmengen: Besteck 100 Stück je Artikel – Geschirr 10 Stück je Artikel.
- Stanzungen:
  - Punzen: erste Punze € 300,00 – jede weitere € 150,00;
  - Stanzkosten: Besteck € 0,50 pro Stück – Geschirr: bitte Kostenvoranschlag anfordern;
  - Mindestmengen:
    - Erstbestellung: Besteck 1.000 Stück je Artikel – Messer mit Hohlheftgriff 800 Stück je Artikel;
    - Folgebestellungen: Besteck 100 Stück je Artikel – Messer mit Hohlheftgriff 800 Stück je Artikel.

## Personalisierungen Sambonet Tailor Made (die angegebenen Beträge sind Nettobeträge)

- Arten Standardgravuren Tailor-Made:
  - Auf dem vorderen Ende des Besteckgriffs: eines der Standardlogos, oder das Monogramm (zwei Buchstaben) mit Standardschriftarten;
  - Auf dem hinteren Ende des Besteckgriffs: Datum im Standardformat, mit einer Standardschriftart;
- Kosten der Gravur Tailor-Made:
  - € 19,90 für Gravuren auf dem Ende des Besteckgriffs / Vorderseite;
  - € 19,90 für Gravuren auf dem Ende des Besteckgriffs / Hinterseite;
  - € 39,80 für Gravuren auf dem Ende des Besteckgriffs / Vorder- und Hinterseite.
- Mindestbestellung für lose Artikel Tailor-Made:
  - 6 St. für die Bezugsprofile in Alpacca, in Vielfachstückelungen von 6 St.;
  - 12 St. für alle anderen Bezugsprofile, in Vielfachstückelungen von 12 St.;
- Anwendung der Preise für die Gravur Tailor-Made auf die einzelne Bestellung:
  - Nur einmalige Zahlung für jede Art von Gravur – wie in Punkt 2 angeführt;
  - Nur einmalige Zahlung unabhängig von der Zahl der Artikel – bei Überschreitung der Mindestbestellung wie in Punkt 3 angeführt;
  - Nur einmalige Zahlung unabhängig von der Stückzahl bis zu 150 St.
  - bei mehr als 150 St. und Vielfachen von 150 St. werden die Kosten für die Gravur erneut veranschlagt.

## Sonderkonditionen für Personalisierungen

- Die Firma behält sich das Recht vor die Personalisierung nicht auszuführen, wenn diese technisch nicht durchführbar ist.
- Bestellungen von kundenindividuellen und/oder nicht standardmäßigen Sonderanfertigungen können nicht storniert werden.
- Kundenindividuell gefertigte Artikel können nicht umgetauscht werden.
- Besondere Verpackungsanfragen gehen zu Lasten des Kunden.

## Vertrieb

- Die Ware ist für die Vermarktung in dem Land, in dem der Kunde ansässig ist, bestimmt. Wenn die Ware in einem anderen Land vermarktet wird, liegt es in der Verantwortung des Kunden, die in diesem Land geltenden Vorschriften einschließlich Zoll- und Einfuhrbestimmungen sowie das Risiko von Streitigkeiten durch Dritte aus irgendeinem Grund zu überprüfen. Es versteht sich, dass Sambonet Paderno Industrie S.p.A. für jede mögliche Streitigkeit, die durch den Verkauf der Ware in diesem anderen Land entstehen kann, schadlos gehalten wird.
- Sambonet Paderno Industrie S.p.A. übernimmt keine Garantie für eventuelle Ansprüche wegen Verletzung von gewerblichen Schutzrechten und Rechten des geistigen Eigentums Dritter, insbesondere im Falle des Weiterverkaufs der Ware über Internet.
- Die Veröffentlichung von Preisen, die unter denen der geltenden Preislisten liegen, ist auf Webseiten ohne Authentifizierung verboten.

## Eigentumsvorbehalt und Zahlungskonditionen

- Eventuelle Beanstandungen können in keinem Fall den Aufschub oder die Unterbrechung der Zahlungen zur Folge haben.
- Bei Zahlungsverzögerungen ist der Kunde im Übrigen gegenüber Sambonet Paderno Industrie S.p.A. rechtmäßiger Schuldner einer pauschalen Erstattung für Mahnaufwendungen, die sich auf € 40,00 beläuft. Wenn die Mahnaufwendungen den oben genannten Betrag überschreiten, hat Sambonet Paderno Industrie S.p.A. das Recht eine weitere Erstattung einzufordern.
- Im Falle der Nichtzahlung des vollständigen oder teilweisen Rechnungsbetrags oder einer Verschlechterung der finanziellen Lage des Kunden hat Sambonet Paderno Industrie S.p.A. auch die Befugnis:
  - laufende Bestellungen und Lieferungen zu unterbrechen oder zu annullieren;
  - eine Vorauszahlung für weitere Bestellungen und/oder Zahlungsverpflichtungen zu verlangen.

## Lieferung

- Die Liefertermine sind so genau wie möglich angegeben, hängen aber von den Materialbeschaffungs- und Transportbedingungen ab. Sambonet Paderno Industrie S.p.A. bemüht sich aufs Äußerste die Auslieferungstermine einzuhalten. Ausgenommen davon sind Fälle von höherer Gewalt.
- Die Überschreitung der vorgesehenen Lieferzeiten verpflichtet Sambonet Paderno Industrie S.p.A. nicht zur Zahlung von Straf-, Schadensersatz- und Zinszahlungen.
- Jede Änderung einer Bestellung hat eine Änderung des Liefertermins zur Folge.
- Als Fälle von höherer Gewalt und somit als Bedingungen, die Sambonet Paderno Industrie S.p.A. von der Lieferpflicht entbinden, gelten: Krieg, Aufruhr, Brand, Streiks, Unmöglichkeit der Materialbeschaffung, erhebliche Unfälle an den Geräten, der Bruch einer Maschine, die Unterbrechung oder Verspätung des Transports.
- Sambonet Paderno Industrie S.p.A. informiert den Kunden rechtzeitig über jede Art von Verspätung. In jedem Fall kann die vereinbarte Lieferung nur erfolgen wenn der Kunde alle seine Verpflichtungen gegenüber Sambonet Paderno Industrie S.p.A. pünktlich erfüllt hat und zwar aus welchem Grund auch immer.
- Darüberhinaus wird zwischen den Parteien vereinbart, dass, wenn der Kunde die bestellten Produkte nicht zu den festgelegten Konditionen entgegen nimmt, Sambonet Paderno Industrie S.p.A. dem Kunden:
  - jede weitere Ausgabe für Transport und/oder Einlagerung;
  - Aufbewahrungskosten in Höhe von 5% des Betrags der Bestellung, ausschließlich Steuer, für jeden Monat Verspätung in Rechnung stellt.

## Wichtige Hinweise

- Da verschiedene Bearbeitungsschritte handwerksmäßig ausgeführt werden, könnten leichte Abweichungen bei unterschiedlichen Warenpartien des selben Produktes auftreten.
- Die Produkte, die mit PVD-Verfahren hergestellt werden, können leichte chromatische Variationen und Farbtöne je nach den verschiedenen Modellen und Bezugsprofilen aufweisen. Diese Variationen sind nicht als Fehler anzusehen, da sie sich innerhalb der vorgesehenen Toleranzwerte bewegen und sorgfältig überwacht werden.
- Beim Druck kann es zu Fehlern und/oder Auslassungen kommen. Sambonet Paderno Industrie S.p.A. behält sich die Korrektur von Druck- oder Rechenfehlern vor.
- Fotos und Abmessungen sind nur als information zu verstehen. Wir behalten uns das Recht vor, die angegebenen Spezifikationen jederzeit zu ändern.
- Das Profil der Bestecke ist nur als Informationskizze zu verstehen. Es stellt nicht dar die wirklichen Profile.

## COPYRIGHT

© Die Vielfältigkeit dieses Katalogs -auch wenn partial- ohne unsere ausdrückliche schriftliche Erlaubnis ist untersagt.

## FRA

### Termes et conditions générales de vente

1. Toute commande est soumise à l'acceptation de Sambonet Paderno Industrie S.p.A.
2. Le montant minimum de commande est de € 250,00 net HT.
3. Emballage standard gratuit.
4. Toute modification de ces conditions doit se faire par écrit.

### Droit de propriété et conditions de paiement

1. Les marchandises fournies restent la propriété de Sambonet Paderno Industrie S.p.A. jusqu'au paiement intégral de la facture par le client.
2. La facture doit être réglée dans le délai préalablement convenu entre les parties. Tout retard de paiement entraînera l'application d'intérêts calculés au taux fixé par l'article 5 du décret législatif italien 231/2002 tel que modifié par le décret législatif italien 192/2012, majoré de 8%.

### Offres/ Commandes

1. Les offres de Sambonet Paderno Industrie S.p.A. sont libres et n'engagent pas à passer une commande.
2. L'acceptation d'une offre par écrit, ou la confirmation de la commande (et les manières qui sont contenu), sera réputée une véritable commande, qui entraîne l'exécution d'un contrat conforme aux termes et aux conditions générales de vente.

### Retours/Réclamations

1. Les marchandises doivent être contrôlées à la réception.
2. En cas de colis défectueux / endommagés, le document de transport devra être signé sous réserve, en spécifiant les raisons (la photo du colis avec l'étiquette logistique et le ruban du transporteur bien en évidence, accompagnée de la description du défaut, vaut réserve).
3. Les réclamations doivent être soumises dans un délai maximum non négociable de 15 jours à compter de la date de la facture, aux conditions suivantes:
  - a) la réclamation / la demande de retour de marchandises doit être soumise en suivant la procédure assistée disponible à l'adresse [www.agenti.sambonet.it](http://www.agenti.sambonet.it) dans l'espace utilisateur;
  - b) Tous les retours de marchandises sont départ notre usine;
  - c) en cas de responsabilité du client, Sambonet Paderno Industrie S.p.A. facturera 15% du prix net, avec un montant minimum de € 25,00, pour les frais de gestion;
  - d) en cas de responsabilité avérée de Sambonet Paderno Industrie S.p.A., les marchandises seront remplacées et retournées franco domicile client;
  - e) pour les produits retournés pour réparation hors garantie, les frais de transport aller-retour sont à la charge du client;
  - f) les retours d'articles spéciaux (hors catalogue), personnalisés ou hors production ne sont pas acceptés.

### Annulation des commandes

1. Les commandes de produits hors catalogue, personnalisés ou spéciaux ne peuvent pas être annulées.
2. Les commandes de produits sur catalogue ne peuvent être annulées que si la commande n'a pas encore été confirmée.

### Conditions de livraison pour les suivants Pays de l'UE (îles exclues) :

#### Belgique, Pays Bas, Luxembourg, France, Espagne, Allemagne

1. Les envois de marchandises sont **départ usine** pour tout montant de commande inférieur à € 500,00.
2. Les envois de marchandises sont **franco domicile client**:
  - a) avec € 60,00 à la charge du client pour tout montant net HT de commande de € 500,00 à € 1.000,00;
  - b) sans aucune charge pour tout montant net HT de commande supérieur à € 1.000,00.
3. Les conditions susmentionnées ne sont valables que pour les envois effectués par le transporteur conventionné avec Sambonet Paderno Industrie S.p.A.

### Conditions de livraison pour les autres Pays de l'UE (îles exclues)

1. Les envois de marchandises sont **départ usine** pour tout montant de commande inférieur à € 500,00.
2. Les envois de marchandises sont **franco domicile client**:
  - a) avec € 60,00 à la charge du client pour tout montant net HT de commande de € 500,00 à € 1.500,00;
  - b) sans aucune charge pour tout montant net HT de commande supérieur à € 1.500,00.
3. Les conditions susmentionnées ne sont valables que pour les envois effectués par le transporteur conventionné avec Sambonet Paderno Industrie S.p.A.

### Conditions de livraison pour les Pays n'appartenant pas à l'UE

1. Tous les envois de marchandises sont départ usine.

### Produits personnalisés (les prix indiqués sont nets)

1. Sambonet Paderno Industrie S.p.A. est en mesure de réaliser des produits personnalisés à la demande du client aux conditions suivantes:
  - a) paiement d'un **acompte de 30%** sur le montant de la commande;
  - b) livraison à convenir après l'approbation du dessin exécutif et/ou de l'échantillon;
  - c) Sambonet Paderno Industrie S.p.A. se réserve le droit d'appliquer à chaque référence une **tolérance** de livraison sur les quantités commandées de +/- 10% arrondie à l'unité supérieure;
  - d) Sambonet Paderno Industrie S.p.A. enverra au client une fiche avec toutes les données techniques nécessaires (dessin, position, dimensions, etc.) et n'exécutera la commande qu'à la réception de la fiche signée pour autorisation.
2. Couteaux à dessert exécutés avec lame dentelée (si cette lame n'est pas la lame standard): € 0,65 par pièce.
3. Gravure pantographe/laser:
  - a) frais de commande: € 70,00;
  - b) frais de gravure: couverts € 0,50 par pièce - plats et articles de table, si gravure faisable, € 1,00 par pièce;
  - c) quantité minimum de commande: couverts 100 pièces pour chaque référence - plats et articles de table 10 pièces pour chaque référence.
4. Poinçonnage:
  - a) frais de poinçon: € 300,00 pour le premier poinçon - € 150,00 pour chaque poinçon supplémentaire;
  - b) frais de poinçonnage: couverts € 0,50 par pièce - plats et articles de table: devis sur demande;
  - c) quantité minimum de commande:
    - première commande: couverts 1.000 pièces par référence - couteaux poignée creuse 800 pièces par référence;
    - commandes suivantes: couverts 100 pièces par référence - couteaux poignée creuse 800 pièces par référence.

### Personnalisations Sambonet Tailor Made (Les prix indiqués sont nets)

1. Types de gravures Tailor Made standard :
  - a) Au recto du manche : un des logos standard ou un monogramme (deux lettres) en utilisant l'une des polices standard ;
  - b) Au verso du manche : la date au format standard en utilisant l'une des polices standard ;
2. Coût de la gravure Tailor Made :
  - a) 19,90 € pour les gravures au recto du manche ;
  - b) 19,90 € pour les gravures au verso du manche ;
  - c) 39,80 € pour les gravures au recto et au verso du manche.
3. Minimum d'achat pour des articles en vrac Tailor Made :
  - a) 6 pièces pour les références en maillechort, par multiple de 6 pièces ;
  - b) 12 pièces pour toutes les autres références, par multiple de 12 pièces ;
4. Application du coût de la gravure Tailor Made sur chaque commande :
  - a) Un coût unique pour chaque type de gravure - indiqués au point 2 ;
  - b) Un coût unique quel que soit le nombre de références - à condition qu'il soit supérieur au minimum d'achat indiqué au point 3 ;
  - c) Un coût unique quel que soit le nombre de pièces jusqu'à 150 pièces.
  - d) Au-delà de 150 pièces et par multiple de 150 pièces, le coût de la gravure sera à nouveau appliqué.

### Conditions spéciales pour les personnalisations

1. L'Entreprise se réserve le droit de ne pas procéder à la personnalisation pour des raisons de faisabilité technique.
2. Les commandes de produits personnalisés e/o spéciaux ne peuvent pas être annulées.
3. Les produits personnalisés ne peuvent pas être retournés pour remplacement.
4. Toute demande d'emballage spécifique est à la charge du Client.

### Commercialisation

1. Les produits sont destinés à la commercialisation dans le Pays où le client est basé. Si les produits sont vendus dans un autre Pays, il est de la responsabilité du client de vérifier les réglementations applicables dans ce Pays, y compris les réglementations douanières et d'importation, ainsi que le risque de litiges par des tiers pour quelque motif que ce soit, étant entendu que Sambonet Paderno Industrie S.p.A. sera déchargé de tout litige qui pourrait survenir dans ce Pays différent.
2. Sambonet Paderno Industrie S.p.A. ne fournit aucune garantie quant à d'éventuelles actions pour violation des droits de propriété industrielle et intellectuelle par des tiers, en particulier en cas de revente du produit sur Internet.
3. Il est interdit de publier des prix inférieurs aux tarifs en vigueur sur des sites Web sans authentification.

### Réserve de propriété et conditions de paiement

1. Toute réclamation du Client ne peut en aucun cas avoir pour effet de différer ou de suspendre le paiement.
2. En cas de retard de paiement, le Client est redevable de plein droit, envers Sambonet Paderno Industrie S.p.A., d'une indemnité forfaitaire de 40,00 € pour frais de recouvrement. Si les frais de recouvrement sont supérieurs à ce montant, Sambonet Paderno Industrie S.p.A. est en droit de réclamer une indemnisation complémentaire.
3. En cas de non-paiement de tout ou partie de la facture, ou en cas de dégradation de la situation financière du Client, Sambonet Paderno Industrie S.p.A. a également le droit de :
  - a) suspendre ou annuler toute commande et livraison en cours ;
  - b) exiger un acompte pour toute nouvelle commande et/ou des garanties de paiement.

### Livraison

1. Les délais de livraison sont indiqués aussi exactement que possible, mais sont fonction des possibilités d'approvisionnement et de transport de Sambonet Paderno Industrie S.p.A., qui s'engage à respecter les délais de livraison avec la plus grande rigueur sauf cas de force majeure.
2. Les dépassements de délai de livraison ne peuvent donner lieu au paiement de pénalités et de dommages-intérêts par Sambonet Paderno Industrie S.p.A.
3. Toute modification de la commande entraînera une modification de la date de livraison.
4. Soit considérés comme cas de force majeure déchargeant Sambonet Paderno Industrie S.p.A. de son obligation de livrer : la guerre, l'émeute, l'incendie, les grèves, l'impossibilité d'être approvisionné, les accidents graves de matériel, les pannes de machines, l'interruption ou le retard dans les transports.
5. Sambonet Paderno Industrie S.p.A. s'engage à informer le Client sans délai de tout retard. En toute hypothèse, la livraison dans les délais ne peut intervenir que si le Client est à jour de ses obligations envers Sambonet Paderno Industrie S.p.A., quelle qu'en soit la cause.
6. Les parties conviennent également que si le Client ne prend pas possession des produits commandés selon les conditions fixées, Sambonet Paderno Industrie S.p.A. lui facturera :
  - a) les frais supplémentaires de transport et/ou de stockage ;
  - b) les frais de garde équivalents à 5 % du montant de la commande, hors taxes, pour chaque mois de retard.

### Avertissements importants

1. Car différents cycles de production sont effectués artisanalement, on pourrait remarquer des légères différences entre différents lots du même produit.
2. Les produits soumis à un traitement PVD peuvent présenter de légères variations de couleurs et de teintes entre les différents modèles ou entre les différentes références. Ces variations ne doivent pas être considérées comme des défauts car elles se situent dans des limites de tolérance définies et font l'objet d'un contrôle strict.
3. Des fautes et/ou des omissions peuvent survenir lors de l'impression. Sambonet Paderno Industrie S.p.A. se réserve le droit de corriger toute faute d'impression ou de calcul.
4. Les photos et dimensions indiquées sont indicatives. Sambonet Paderno Industrie S.p.A. se réserve le droit de modifier à tout moment les spécifications techniques.
5. Les silhouettes des couverts de ce tarif sont uniquement indicatives et elles ne se réfèrent pas à la silhouette réelle des couverts.

### COPYRIGHT

© Toute reproduction ou reproduction partielle de ce catalogue est interdite sauf expressément autorisée par Sambonet Paderno Industrie S.p.A.



## Condiciones generales y de venta

1. Los pedidos deben ser aprobados por Sambonet Paderno Industrie S.p.A.
2. Pedido mínimo de **€ 250,00 en factura**.
3. Embalaje estándar incluido.
4. Cualquier variación de las presentes condiciones debe realizarse por escrito.

## Derecho de propiedad y condiciones de pago

1. La mercancía queda de propiedad de Sambonet Paderno Industrie S.p.A. hasta que el cliente realice el pago total de la factura.
2. El plazo de pago de la factura debe realizarse dentro de los términos establecidos previamente por las partes. Al caducar dicho plazo, deberán considerarse los intereses de demora según lo dispuesto por el art. 5 D.LGS 231/2002 y siguientes modificaciones, como previsto en el D.LGS. 192/2012, con aumento del 8%.

## Ofertas/Pedidos

1. Las ofertas de Sambonet Paderno Industrie S.p.A. son libres y no vinculantes al pedido.
2. Aceptando por escrito la oferta, o de la confirmación del pedido (con la modalidad en ella incluidas) se produce a todos los efectos un pedido que implica un contrato conforme a las condiciones generales y de venta.

## Restituciones/Reclamaciones

1. La mercancía debe controlarse en el momento de la entrega.
2. En caso de embalajes defectuosos/deteriorados, el documento de transporte se deberá firmar bajo reserva especificando las razones (como reserva se debe presentar la foto del embalaje y su código de barra, la cinta del servicio de transporte y la descripción de la avería).
3. Las reclamaciones se aceptarán dentro de **15 días** a partir de la fecha de emisión de la factura, plazo no negociable, bajo las condiciones que se citan a continuación:
  - a) La reclamación/solicitud de restitución de mercancía debe realizarse a través del procedimiento guiado en la página web: [www.agenti.sambonet.it](http://www.agenti.sambonet.it) en el área de usuarios;
  - b) La mercancía se entrega franco nuestra fábrica;
  - c) En caso de que el cliente sea responsable, Sambonet Paderno Industrie S.p.A. le cargará el 15% del precio neto, con un mínimo de € 25,00 de coste de gestión;
  - d) en caso de responsabilidad comprobada de Sambonet Paderno Industrie S.p.A., la mercancía será reemplazada y entregada al cliente con porte pagado;
  - e) los gastos de transporte para la reparación de productos sin garantía, corren a cargo del cliente;
  - f) para los artículos especiales (no incluidos en el catálogo), personalizados o fuera de producción no será posible restituir la mercancía.

## Cancelación del pedido

- a) para los productos no incluidos en el catálogo, personalizados o especiales NO es posible cancelar el pedido.
- b) para los productos incluidos en el catálogo, es posible cancelar el pedido sólo en caso de que aún no haya sido confirmado.

## Condiciones de entrega en los demás Países UE (islas excluidas)

### Bélgica, Holanda, Luxemburgo, Francia, España, Alemania

1. Los pedidos cuyo importe no alcance los € 500,00 se remiten **franco fábrica**.
2. La mercancía se remite a **porte pagado**:
  - a) cargando € 60,00 para pedidos de entre € 500,00 y € 1.000,00 netos;
  - b) sin cargo alguno si el pedido neto sobrepasa los € 1.000,00.
3. Las condiciones mencionadas arriba deben considerarse válidas sólo para los servicios de transporte elegidos por Sambonet Paderno Industrie S.p.A.

## Condiciones de entrega en los Países extra UE (islas excluidas)

1. Los pedidos cuyo importe no alcance los € 500,00 se remiten **franco fábrica**.
2. La mercancía se remite a **porte pagado**:
  - a) cargando € 60,00 para pedidos de entre € 500,00 y € 1.500,00 netos;
  - b) sin cargo alguno si el pedido neto sobrepasa los € 1.500,00.
3. Las condiciones mencionadas arriba deben considerarse válidas sólo para los servicios de transporte elegidos por Sambonet Paderno Industrie S.p.A.

## Condiciones de entrega en los Países extra UE

1. La mercancía se entrega **franco fábrica**.

## Personalizaciones (Los precios indicados deben considerarse netos)

1. Bajo solicitud del cliente, Sambonet Paderno Industrie S.p.A. realiza personalizaciones y acabados particulares según las siguientes condiciones:
  - a) **pago de un anticipo del 30%** del valor del pedido;
  - b) La entrega será establecida tras aprobar el diseño ejecutivo y/o la muestra;
  - c) Sambonet Paderno Industrie S.p.A. se reserva el derecho de aplicar, en cada artículo, una **tolerancia** del +/- 10%, redondeando por exceso, para el envío de las cantidades solicitadas;
  - d) Sambonet Paderno Industrie S.p.A. enviará al cliente una ficha con toda la información necesaria (diseño, posición, medidas, ecc). La entrega se efectuará sólo después de haber recibido la ficha firmada por el cliente.
2. Endentado de hojas cuchillos poste: si no previsto de serie, con cargo de € 0,65 / pieza.
3. Grabado por Pantógrafo/Láser:
  - a) coste instalación: € 70,00;
  - b) coste grabado: cubiertos € 0,50 / pieza – vajilla, grabado (si es posible) € 1,00 / pieza;
  - c) cantidades mínimas. Cubiertos: 100 piezas por modelo - vajilla: 10 piezas por modelo.
4. Punzonado:
  - a) coste punzones: € 300,00 para el primer punzón - € 150,00 para los siguientes (cada uno);
  - b) coste punzonado: cubiertos € 0,50 / pieza - vajilla: solicitando un presupuesto;
  - c) pedidos mínimos:
    - nuevas instalaciones. Cubiertos: 1.000 piezas por modelo - cuchillos de mango hueco: 800 piezas por modelo;
    - pedidos adicionales. Cubiertos: 100 piezas por modelo - cuchillos de mango hueco: 800 piezas por modelo.

## Personalizaciones Sambonet Tailor Made (Los costes indicados son netos)

1. Tipos de grabados Tailor Made estándar:
  - a) En el terminal frontal: uno de los logotipos estándar, o el monograma (dos letras) usando uno de los caracteres estándar;
  - b) En el terminal trasero: la fecha en formato estándar, utilizando uno de los caracteres estándar;
2. Coste de grabado Tailor Made:
  - a) € 19,90 para grabados en el terminal frontal;
  - b) € 19,90 para grabados en el terminal trasero;
  - c) € 39,80 para grabados en el terminal delantero y en el terminal trasero.
3. Pedido mínimo de compra para artículos sueltos Tailor Made:
  - a) 6 pzas para las referencias hechas en alpaca, con múltiples de 6 pzas;
  - b) 12 pzas para todas las otras referencias, con múltiples de 12 pzas;
4. Aplicación del coste de grabado Tailor Made en un único pedido de compra:
  - a) Un solo coste para cada tipo de grabado - indicados en el punto 2;
  - b) Un solo coste independientemente del número de referencias - si superiores al mínimo de compra indicado en el punto 3;
  - c) Un solo coste independientemente del número de pzas hasta 150 pzas.
  - d) Con más de 150 pzas y múltiples de 150 pzas se aplicará otra vez el coste de grabado.

## Condiciones especiales para las personalizaciones

1. La Empresa se reserva el derecho de no llevar a cabo la personalización si no fuera técnicamente realizable.
2. Pedidos personalizados y/o acabados particulares no se pueden cancelar.
3. No se pueden devolver, para su reemplazo, los productos personalizados.
4. Las solicitudes de embalajes específicos correrán a cargo del Cliente.

## Comercialización

1. Los productos están destinados a la comercialización en el País donde se encuentra el cliente. Si los productos se comercializan en un País diferente, será responsabilidad del cliente verificar las regulaciones aplicables en ese País, incluidas las regulaciones de aduanas e importación, así como el riesgo de disputas por parte de terceros por cualquier motivo, entendiéndose que Sambonet Paderno Industrie SpA estará libre de cualquier disputa que pueda surgir en este País diferente.
2. Sambonet Paderno Industrie S.p.A. no ofrece ninguna garantía con respecto a posibles reclamos de violación de derechos de propiedad industrial e intelectual de terceros, en particular en el caso de reventa de los productos a través de Internet.
3. Está prohibido publicar precios inferiores a las listas de precios vigentes en sitios web sin autenticación.

## Reserva de propiedad y condiciones de pago

1. Cualquier reclamación no podrá, en ningún caso, tener como efecto el retraso o la suspensión de los pagos.
2. Además, en situaciones de retraso en el pago, el Cliente será deudor de derecho, para con Sambonet Paderno Industrie S.p.A. de una indemnización a tanto alzado por los gastos de requerimiento igual a € 40,00. Si los gastos de requerimiento son más altos que la cantidad mencionada anteriormente, Sambonet Paderno Industrie S.p.A. tendrá derecho a solicitar una compensación adicional.
3. En caso de falta de pago de toda o parte de la factura, o de empeoramiento de la situación financiera del Cliente, Sambonet Paderno Industrie S.p.A. también tendrá el derecho de:
  - a) suspender o cancelar los pedidos y las entregas en curso;
  - b) exigir un pago por adelantado para los pedidos y/o garantías de pago sucesivos.

## Entrega

1. Los plazos de entrega se indican lo más exactamente posible, pero dependen de las condiciones de abastecimiento y transporte de Sambonet Paderno Industrie S.p.A., que se compromete a poner la máxima diligencia para cumplir con las entregas, excepto en casos de fuerza mayor.
2. Exceder los tiempos de entrega previstos no puede vincular Sambonet Paderno Industrie S.p.A. al pago de sanciones o indemnizaciones por daños e intereses.
3. Cualquier modificación del pedido dará lugar a una consecuente modificación de la fecha de entrega.
4. Se consideran causas de fuerza mayor que liberan Sambonet Paderno Industrie S.p.A. de la obligación de la entrega: guerra, revuelta, incendio, huelgas, imposibilidad de abastecimiento, accidentes especialmente relevantes al equipo de fabricación, la rotura de máquinas, la interrupción o el retraso en el transporte.
5. Sambonet Paderno Industrie S.p.A. informará al Cliente de forma tempestiva sobre cualquier retraso. En cualquier caso, la entrega dentro de los plazos solo se puede realizar si el Cliente ha cumplido debidamente con todas sus obligaciones para con Sambonet Paderno Industrie S.p.A., cualquiera sea la causa.
6. También se acuerda entre las partes que si el Cliente no toma posesión de los productos pedidos bajo las condiciones establecidas, Sambonet Paderno Industrie S.p.A. facturará al Cliente:
  - a) cualquier costo adicional de transporte y/o almacenamiento;
  - b) gastos de custodia equivalentes al 5% del monto del pedido, excluidos los impuestos, para cada mes de retraso.

## Advertencias importantes

1. Puesto que diferentes fases del mecanizado se efectúan con un cuidado artesanal, podrían manifestarse pequeñas diferencias entre distintos lotes del mismo artículo.
2. Los productos sujetos al procesamiento PVD pueden estar sujetos a ligeras variaciones de color y tono entre diferentes modelos o entre diferentes referencias. Estas variaciones no deben considerarse defectos, ya que están dentro de los límites de tolerancia preestablecidos y se controlan estrictamente.
3. Al imprimir puede que surjan errores y/o omisiones. Sambonet Paderno Industrie S.p.A. se reserva el derecho a rectificar eventuales errores de impresión o de cálculo.
4. Fotos, datos y medidas que aparecen en este catálogo son indicativos y susceptibles, sin previo aviso, de modificación.
5. Los perfiles de los cubiertos de la lista de precios son meramente simbólicos y no corresponden a los perfiles reales.

## COPYRIGHT

© Queda prohibida la reproducción total o parcial de este catálogo sin autorización de forma expresa y por escrito de Sambonet Paderno Industrie S.p.A.

**FOTO - PHOTO**

**Riccardo Bianchi**  
**Felice Scoccimarro**

**STAMPA - PRINT**

**Graphicscalve S.p.A.**

MEMBER  
OF 

**ARCTURUS** GROUP

**© COPYRIGHT**

- Ogni riproduzione anche parziale del presente catalogo è vietata se non espressamente autorizzata per iscritto da Sambonet Paderno Industrie S.p.A.
- This catalogue may not be reproduced in whole or in part unless specific prior written authorization of Sambonet Paderno Industrie S.p.A.
- Die Vervielfältigung dieses Katalogs -auch wenn partial- ohne unsere ausdrückliche schriftliche Erlaubnis ist untersagt.
- Toute reproduction ou reproduction partielle de ce catalogue est interdite sauf expressément autorisée par Sambonet Paderno Industrie S.p.A.
- Queda prohibida la reproducción total o parcial de este catálogo sin autorización de forma expresa y por escrito de Sambonet Paderno Industrie S.p.A.

**NOTE - NOTES**

- Le misure, caratteristiche ed illustrazioni dei prodotti sono indicative e soggette a variazioni senza preavviso qualora esigenze tecnico produttive lo richiedessero.
- The pictures illustrated and data are representatives. We reserve the right to alter at any time the specifications stated without notice, whenever technical requirements shall so demand.
- Fotos und Abmessungen sind nur als information zu verstehen. Wir behalten uns das Recht vor, die angegebenen Spezifikationen jederzeit zu ändern, sofern es aus produktionstechnischen Gründen erforderlich ist.
- Les photos et dimensions indiquées sont indicatives. Nous nous réservons le droit de modifier à tout moment les spécifications techniques, si la situation l'exige.
- Fotos, datos y medidas que aparecen en este catálogo son indicativos y susceptibles, sin previo aviso, de modificación por exigencias técnicas o de producción.



# PADERNO<sup>®</sup>



---

## WORLD CUISINE

---

PARTNER OF THE BEST CUISINE

**SAMBONET PADERNO INDUSTRIE S.P.A.**

Via Giovanni Coppo 1,C - 28060 Orfengo (NO) - Italy

Ph. +39 0321 1916 601

Fax +39 0321 1916 890

[horeca@paderno.it](mailto:horeca@paderno.it)

[www.hotel.paderno.it](http://www.hotel.paderno.it)

**ROSENTHAL SAMBONET USA LTD.**

685 Route 10 - Randolph NJ 07869 - USA

Ph. +1 201 804 8000

Fax +1 201 842 9195

[info@rosenthalusa.com](mailto:info@rosenthalusa.com)

[www.rosenthal-hotel-restaurant.com](http://www.rosenthal-hotel-restaurant.com)

MEMBER  
OF   
ARCTURUS GROUP

XA9084 - Ed. 7/2020

