



VEREINIGTE  
FÜLLKÖRPER-FABRIKEN  
GMBH & CO. KG

MADE IN GERMANY

# Your expert for tower packings, catalyst support material and column equipment

chemical and  
petrochemical  
industries



environmental  
engineering



one source,  
one site





**MADE IN GERMANY**

DURANIT®  
INERT BALLS /  
CATALYST  
SUPPORT

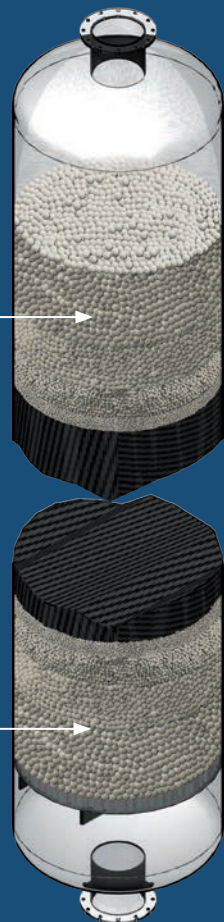

DROPLET  
SEPARATORS  
(DEMISTER)

LIQUID  
DISTRIBUTORS /  
COLLECTORS

SUPPORT PLATES,  
GRIDS





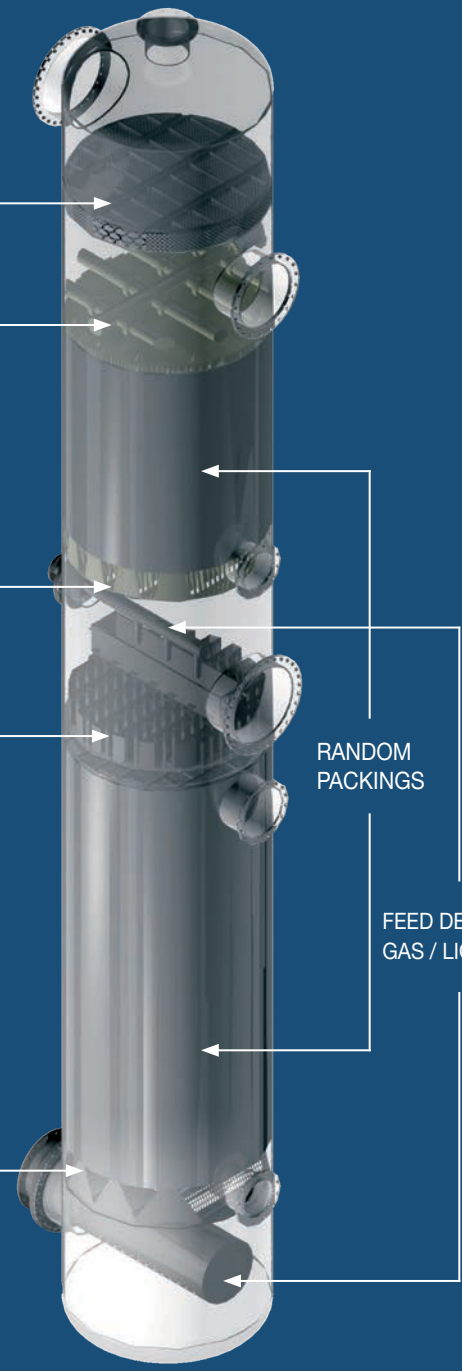



RANDOM  
PACKINGS

FEED DEVICES:  
GAS / LIQUID





# CONTENT

PRODUCT RANGE – RANDOM PACKINGS	4	
PRODUCT RANGE – COLUMN INTERNALS	5	
VFF – YOUR EXPERT ...	6	
DURANIT® INERT BALLS / CATALYST SUPPORT	8	
VFF-DuraTop®	11	
RANDOM PACKINGS MADE OF CERAMIC AND TRANSITIONAL GRID LININGS	12	
VFF-Power-Pak®	12	
RANDOM PACKINGS MADE OF METAL	16	
VFF-Twin-Pak®	20	
RANDOM PACKINGS MADE OF PLASTIC	22	
VFF-NetBall®	26	
SUPPORT PLATES, GRIDS	28	
LIQUID DISTRIBUTORS / COLLECTORS	32	
FEED DEVICES: GAS / LIQUID	35	
DROPLET SEPARATORS (DEMISTER)	36	
VFF RANDOM PACKING SOFTWARE	40	
CONTACT ...	42	
HOW TO REACH US	43	



# PRODUCT RANGE – RANDOM PACKINGS







## DURANIT® INERT BALLS / CATALYST SUPPORT

DURANIT® Inert Balls 	DURANIT® X500-Inert Balls 	DURANIT® D92 Alumina 	DURANIT® D99 High Alumina 	DURANIT® Porcelain-Inert Balls 
VFF-DuraTop® 	Special shapes: 			

## RANDOM PACKINGS MADE OF CERAMIC AND TRANSITIONAL GRID LININGS

Novalox®-Saddle 	Berl-Saddle 	Cylindrical Ring 	Pall®-Ring 	Special shapes 
Transitional grid linings: 				VFF-Power-Pak® 





## RANDOM PACKINGS MADE OF METAL

Cylindrical Ring 	Pall®-Ring 	VSP® 	Top-Pak® 	Novalox®-M 
VFF-Twin-Pak® 	Interpack® 			

## RANDOM PACKINGS MADE OF PLASTIC

Pall®-Ring 	VSP® 	VSP®-V 	Novalox®-Saddle 	Igel® 	VFF-NetBall® 
---	---	---	--	--	---

## LABORATORY PACKINGS

Berl-Saddle 	Cylindrical Ring 	Cylindrical Ring 	Interpack® 
--	---	---	---

# PRODUCT RANGE – COLUMN INTERNALS



## SUPPORT PLATES, GRIDS



## LIQUID DISTRIBUTORS / COLLECTORS

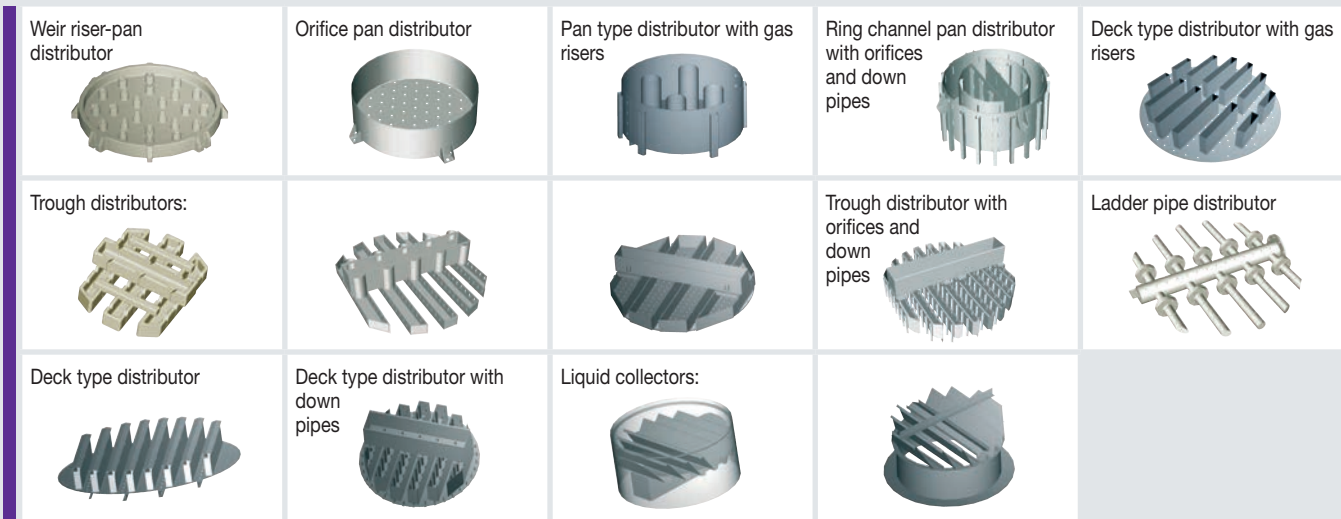

## FEED DEVICES: GAS / LIQUID



## DROPLET SEPARATORS (DEMISTER)

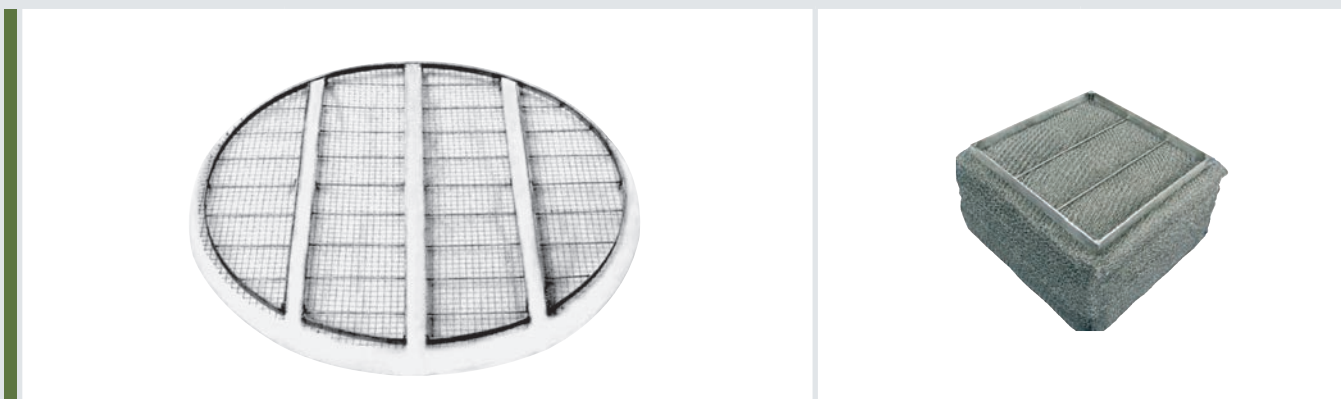



# VFF – YOUR EXPERT FOR DECADES IN TOWER PACKINGS AND COLUMN INTERNALS ‘MADE IN GERMANY’

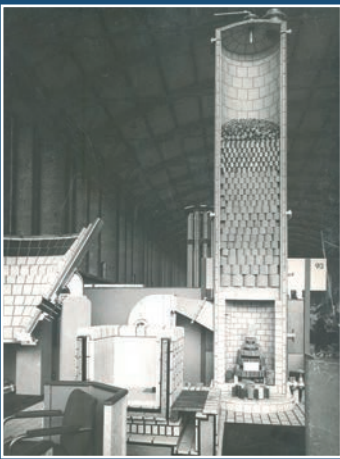

Founded in 1967, VFF has developed into the largest producer of tower packings and Inert Balls in Europe in a short period of time, thanks to the right products and high quality standards. VFF has now become a globally operating company with approx. 30 qualified representatives.

**Vereinigte Füllkörper-Fabriken GmbH & Co. KG (VFF) is Europe's largest producer of tower packings and Inert Balls.**

VFF delivers a complete range of tower packings, Inert Balls, column internals, plastic packings and droplet separators (demister) for all applications in mass and heat transfer – in all relevant materials and sizes. The program is rounded off by a professional consulting service, including analysis with the VFF Random Packing Software.

## COMPETENCE AND KNOW-HOW

VFF products are used around the world in various sectors – e.g. in the petrochemical and chemical industries, in process engineering and in environmental technology – under a variety of conditions. With many years of application know-how at its disposal, VFF can provide customer support for numerous types of questions and offers appropriate solutions. Decades of experience and successful cooperation with renowned companies makes VFF a reliable partner worldwide.

## INNOVATION

Active research and development based on the customer's order as well as enhancement and new development of products and materials ensure that the range is continually expanded, making VFF a qualified partner that recognizes customer needs and knows how to implement them. In the VFF laboratory and test facility, expanded and rebuilt, and in close cooperation with universities and institutes, VFF is constantly working on the optimization of known processes and the realization of customer wishes.

## QUALITY “MADE IN GERMANY”

VFF offers the customer a maximum of operational reliability through qualitative high-grade products! VFF guarantees high product quality through internal testing as well as external controls within the scope of certification according to DIN EN ISO 9001 and continuously tests opportunities for improvement. In addition to the production process control by VFF employees, the process stages are, of course, also monitored and recorded by complex electronic equipment.

The processing of our own raw materials on the most modern machines likewise contributes to a consistent product quality. In order to be able to offer the customer the maximum possible operational reliability and quality, VFF relies on 100% “Made in Germany.”

## FLEXIBILITY AND SERVICE

Due to a large production capacity, VFF can be very flexible in regard to customer wishes and can react quickly. The main focuses of the company's philosophy are:



## VFF – ADVANTAGES AT A GLANCE

- Europe's largest producer of catalyst support material and random packings
- More than 30 agencies worldwide
- 100% Made in Germany
- All relevant sizes and materials
- Short time availability
- Highest available safety as a result of highest quality
- Exclusive raw materials from own mines
- Produced directly from VFF according to German safety standards for employees and environment
- The latest high-performance random packing in metal
- Unequalled high compression strength Duranit® Inert Balls
- ISO 9001 certified since 1994
- Competent technical advice
- Tailor Made products individually designed for the needs of the VFF customers
- VFF Random Packing Software
- Internal and external quality tests
- All from one source
- Continuous new and further development of the VFF-products

individual support for customers, appealing products, the highest quality standards as well as prompt and just-in-time delivery.

The VFF Random Packing Software supports customers in the necessary calculations.

### FUTURE PROSPECTS

VFF has far surpassed the existing standards, services and specifications for the total product-portfolio through a future-oriented development

program. In the catalyst support and Inert Balls product group, Inert Balls are available under the designation DURANIT® X500, which far surpasses all commercially available Inert Balls in their class in durability. This new quality standard offers the maximum reliability, even under the roughest conditions during storage, transportation and reactor filling to VFF customers.

VFF has developed the VFF-NetBall®, which belongs to the product range of random packings made of plastics, and introduced this high performance

random packing already successfully onto the market.

The product range of random packings in metal has been completed with the VFF-Twin-Pak® (a VFF patent). This newly developed high performance random packing combines an extremely low pressure drop with the best possible mass transfer and is characterized by highest capacity. The VFF-Twin-Pak® is already used successfully in different installations worldwide.



# DURANIT® INERT BALLS / CATALYST SUPPORT

For decades, VFF has supplied DURANIT® Inert Balls worldwide to renowned licensors and end customers for processes in the chemical and petrochemical industries, as well as supporting and covering layers for catalysts and contact masses in other industrial sectors.

DURANIT® X500, an upgrade of the well-known and since decades successful DURANIT®-quality, is characterized by an unprecedented high level of operational reliability. Compressive strength for the 1" size is well beyond 1,000 kg, offering the system operator unsurpassed operational safety.

Another advantage of DURANIT® X500 grade is its very low level of water absorption. Naturally, DURANIT® X500 grade is free of any catalyst toxins, in the same way as our proven original DURANIT® grade. Both types are therefore exceptionally well

suited for use in the most varied applications.

In addition to DURANIT® Inert Balls, we also produce other shapes such as solid cylinders, hollow cylinders and prisms as supporting and covering layers for contact masses in reactors.

The processes in which catalyst supports are used in accordance with international specifications encompass the entire spectrum of thermal or catalytic mass conversion:

- Alkylation
- Dehydrogenation
- Desulfurization
- Catalytic cracking

- Catalytic conversion
- Catalytic oxidation
- Catalytic reforming
- Hydrofining
- Isomerisation
- Powerforming
- Thermal cracking
- And other processes

After filling the reactor, the catalyst supports take up the weight of the catalyst bed and are subjected to reaction conditions. The catalyst supports must not trigger any changes in the process. In order to ensure that the upper smaller balls or materials do not 'trickle through' the layer of larger balls directly below, the nominal size ratio between 'larger' and 'smaller' balls is, as a rule, between 2:1 and 4:1.

All VFF ball grades are suitable for a sudden release of high pressure at higher temperatures. For this reason, VFF only uses selected raw materials from their own sources.

For the production of all the DURANIT® Inert Balls VFF uses the most modern computer-controlled production methods and conducts regular, stringent quality inspections.







#### DURANIT® Inert Balls

▶ 1/8", 1/4", 3/8", 1/2", 5/8", 3/4", 1",  
1 1/4", 1 1/2", 2", 3", 4"



#### DURANIT® X500-Inert Balls

▶ 1/8", 1/4", 3/8", 1/2", 5/8", 3/4", 1", 1 1/4"



#### DURANIT® D92 Alumina

▶ 1/4", 3/8", 1/2", 5/8", 3/4"



#### DURANIT® D99 High Alumina

▶ 1/8", 1/4", 3/8", 1/2", 5/8", 3/4", 1", 1 1/4",  
1 1/2", 2", 3"



#### DURANIT® Porcelain-Inert Balls

▶ 1/8", 1/4", 3/8", 1/2", 5/8", 3/4", 1", 1 1/4"



#### Special shapes

Materials are available in each case based on the application, for example the DURANIT® grade as well as various special bodies with high Al<sub>2</sub>O<sub>3</sub> content. VFF covers nominal sizes of 1/8" through 3" for catalyst supports.

Of course, DURANIT® Inert Balls and other shapes can be utilized for other applications, such as in high temperature filtration for the separation of solid or liquid particles from hot exhaust gases.

#### Brochure „DURANIT®“

The brochure  
can be  
downloaded under  
[www.vff.com](http://www.vff.com) or  
requested at VFF!

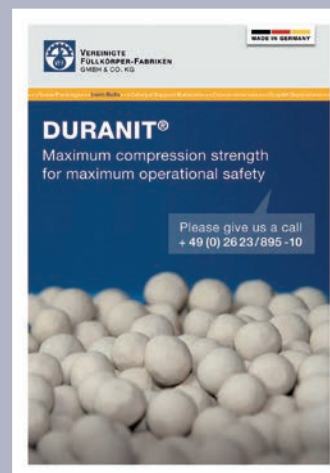



# DURANIT® INERT BALLS / CATALYST SUPPORT

## Physical-chemical properties

Average Inert Ball values

Parameter	Unit	DURANIT®	DURANIT® X500	DURANIT® D92 Alumina	DURANIT® D99 High Alumina
SiO <sub>2</sub>	%	max. 80	max. 80	max. 7	max. 0,2
Al <sub>2</sub> O <sub>3</sub>	%	min. 20	min. 20	min. 90	~ 99
Fe <sub>2</sub> O <sub>3</sub> + TiO <sub>2</sub>	%	max. 4	max. 4	max. 2	max. 1
K <sub>2</sub> O + Na <sub>2</sub> O	%	max. 4	max. 4	max. 0,5	max. 0,4
CaO + MgO	%	max. 1	max. 1	max. 0,5	max. 0,2
Roundness	dmax / dmin	< 1,25	< 1,25	< 1,25	< 1,25
Void Space	%	40 - 45	40 - 45	40 - 45	40 - 45
Compressive Strength	kg	Exceeds all international specifications			
Material Density	g/cm <sup>3</sup>	2,2 - 2,5	2,2 - 2,5	3,0 - 3,4	3,0 - 3,6
Water absorption	%	< 3	< 0,25	2 - 6	2 - 7
BET-surface	m <sup>2</sup> /g	< 0,1	< 0,1	< 0,1	< 0,1
Mohs-Hardness	Mohs	~ 8	~ 8	~ 8	~ 9
Max. application temp.	°C	1000	1000	1600	1800
Expansion coefficient	1/K	4,7 x 10 <sup>-6</sup>	4,7 x 10 <sup>-6</sup>	5 x 10 <sup>-6</sup>	6,7 x 10 <sup>-6</sup>
Spec. thermal heat	kJ / (kg x K)	~ 0,84	~ 0,84	~ 1,1	~ 1,1
Thermal conductivity	kJ / (m x h x K)	~ 6,3	~ 6,3	~ 8	~ 14,6

Special ceramic upon request. Carbon (full cylinders) upon request.

## Physical properties

Average Inert Ball values

Nominal size ["] Inches	Diameter [mm]	Spec. surface [m <sup>2</sup> /m <sup>3</sup> ]	DURANIT® Bed weight** [kg/m <sup>3</sup> ]	DURANIT® X500 Bed weight** [kg/m <sup>3</sup> ]	DURANIT® D92 Alumina Bed weight** [kg/m <sup>3</sup> ]	DURANIT® D99 High Alumina Bed weight** [kg/m <sup>3</sup> ]
1/8	3-5	1285	1300 ... 1400	1300 ... 1400	--	2000 ... 2200
1/4	6-8	500	1300 ... 1400	1300 ... 1400	2000 ... 2100	2000 ... 2200
3/8	9-11	350	1300 ... 1400	1300 ... 1400	2000 ... 2100	2000 ... 2200
1/2	11-14	280	1300 ... 1400	1300 ... 1400	2000 ... 2100	2000 ... 2200
5/8	14-17	220	1300 ... 1400	1300 ... 1400	2000 ... 2100	2000 ... 2200
3/4	19-21	170	1300 ... 1400	1300 ... 1400	2000 ... 2100	2000 ... 2200
1	23-28	125	1300 ... 1400	1300 ... 1400	--	2000 ... 2200
1,25	29-35	105	1300 ... 1400	1300 ... 1400	--	2000 ... 2200
1,5	35-43	85	1300 ... 1400	*)	--	2000 ... 2200
2	48-55	65	1300 ... 1400	*)	--	2000 ... 2200
3	72-80	45	1300 ... 1400	*)	--	1900 ... 2000
4	98-110	32	1200 ... 1300	*)	*)	*)

Generally accepted tolerances apply to all ceramic products. Special geometric properties (full cylinders, prisms, etc.) upon request

\*\*Bed weight = Spec. weight

\*) upon request



DuraTop® special reformed packings are used among other things for covering catalyst beds. DuraTop® special reformed packings can be added onto the top ball layer or even replace the top ball layer.

As the top layers on the catalyst beds DuraTop® special reformed packings offer the following advantages:

- low pressure drop because of large free-gap volume
- good pre-distribution of the liquid and gaseous media, even before they reach the catalyst bed, due to open internal structure of the DuraTop® special reformed packing
- the large specific surface increases the retention of any particulate impurities of the media before they reach the catalyst bed.

## Physical properties

Description	Nominal size	Diameter [mm]	Height [mm]	Spec. weight [kg/m³]	Spec. surface [m²/m³]	Free volume [%]
VFF-DuraTop®	1/2"	12 ... 13	7 ... 8	approx. 1000	640	approx. 55
VFF-DuraTop®	3/4"	19 ... 20	10 ... 11	approx. 850	400	approx. 65
VFF-DuraTop®	1"	25 ... 26	12 ... 14	approx. 850	330	approx. 60

(Free volume = Void space)



VFF-DuraTop®

▶ 1/2", 3/4", 1"

## Brochure „VFF-DuraTop®“

The brochure can be downloaded under [www.vff.com](http://www.vff.com) or requested at VFF!





# RANDOM PACKINGS MADE OF CERAMIC AND TRANSITIONAL GRID LININGS

VFF has a comprehensive program of ceramic materials, which has been used worldwide for many decades in a large variety of absorption, desorption, distillation and extraction processes as well as for heat storage, including applications in gas purification, water treatment and product purification.

A wide range of all important packing shapes and sizes are manufactured in the VFF production facilities. Raw materials, manufacturing and firing are subject to continual, strict controls within the framework of the VFF operational quality assurance and external counterchecks.

VFF packing materials from ceramic materials offer a high service life and are extremely durable in acidic washing solutions, even under high operating temperatures.

Upon request, VFF will conduct a theoretical calculation of the

columns basic design based on the operating conditions provided and will submit, for example, the following design recommendations:

- Optimal packing materials (type, size, material)
- Necessary column diameter
- Pressure drop
- Hold up
- HTU and NTU values (packing height)
- Construction of the support plates
- Construction of the liquid distributor

- Recommendations as to what extent a liquid redistributor should be used, to what extent a hold down grid or a droplet separator (demister) including the design should be used.

With the VFF packing software, the column basic design can be calculated on a theoretical basis, including column diameter, bed height, etc.

## VFF-Power-Pak® High performance random packing in ceramic

**New**

Extremely low  
pressure drop

Impressive  
mass transfer

Different sizes

For further information:  
Tel.: + 49 (0) 2623 / 895 - 10  
Mail: [keramik@vff.com](mailto:keramik@vff.com)



**Cylindrical Ring**

▶ 5-200 mm



**Pall®-Ring**

▶ 25, 35, 50, 80, 100 mm



**Novalox®-Saddle**

▶ 1/2", 3/4", 1", 1 1/2", 2", 3"



**Berl-Saddle**

▶ 4, 6, 8, 10, 15, 25, 35, 50, 80 mm



**Special shapes\***

\*) Additional designs upon request.

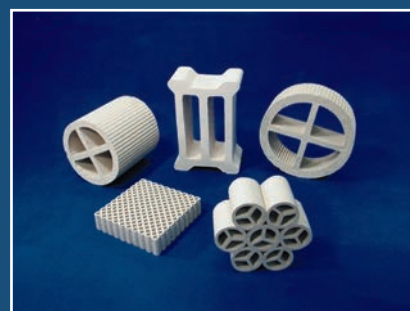



**Transitional grid linings\***

Description	Remarks / Comparison to Other Packings
Cylindrical Ring	Cylindrical Ring: the simplest packing shape
Pall®-Ring	Lower pressure drop than Novalox®-Saddle, more extensive manufacturing process than Novalox®-Saddle
Novalox®-Saddle	Approved for years, very efficient packing material; applicable for all separation processes; very good price / performance ratio
Berl-Saddle	Higher mass transfer performance than Novalox®-Saddle, more advantageous geometry than Novalox®-Saddle
Special shapes	Upon request and in coordination with the VFF customer

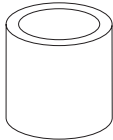
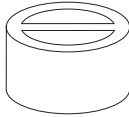
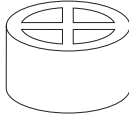
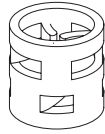

# RANDOM PACKINGS MADE OF CERAMIC AND TRANSITIONAL GRID LININGS

## Physical properties

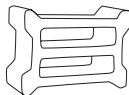
Description	Nominal size	Spec. weight [kg/m <sup>3</sup> ]	Spec. surface [m <sup>2</sup> /m <sup>3</sup> ]	Free volume [%]
<b>Cylindrical Ring</b> 	5 mm	900	1000	63
	6 mm	880	940	64
	8 mm	870	550	65
	10 mm	850	450	66
	12 mm	720	360	67
	15 mm	700	310	72
	20 mm	650	240	74
	25 mm	620	190	74
	30 mm	570	165	77
	38 mm	560	130	78
	50 mm	550	98	78
	60 mm	520	78	79
	70 mm	530	72	78
	80 mm	520	60	77
	80 mm**	770	88	67
	100 mm**	580	65	75
120 mm**	550	55	77	
150 mm**	600	45	75	
200 mm**	610	33	74	
<b>1 Bar</b> 	80 mm**	825	108	65
	100 mm**	690	83	71
	120 mm**	650	70	72
	150 mm**	740	57	69
	200 mm**	735	42	69
<b>1 Cross</b> 	80 mm**	990	125	58
	100 mm**	790	99	66
	120 mm**	760	83	68
	150 mm**	865	68	63
	200 mm**	845	50	64
<b>Pall®-Ring</b> 	25 mm	620	220	75
	35 mm	540	165	78
	50 mm	550	120	78
	80 mm	520	80	79
	100 mm	450	55	82
<b>Novalox®-Saddle</b> 	1/2"	685	622	73
	3/4"	660	335	74
	1"	640	255	74
	1,5"	620	166	75
	2"	580	120	77
	3"	570	92	77
<b>Berl-Saddle</b> 	4 mm	1050	2000	54
	6 mm	950	1150	60
	8 mm	950	980	60
	10 mm	850	660	65
	15 mm	780	430	67
	25 mm	700	260	70
	35 mm	650	178	73
	50 mm	600	120	75
	80 mm	550	60	75
<b>Grid Block</b> 	215 x 145 x 90 mm	90	-	50

Generally accepted tolerances apply to all ceramic products. \*\*) systematically stacked

### Hold up

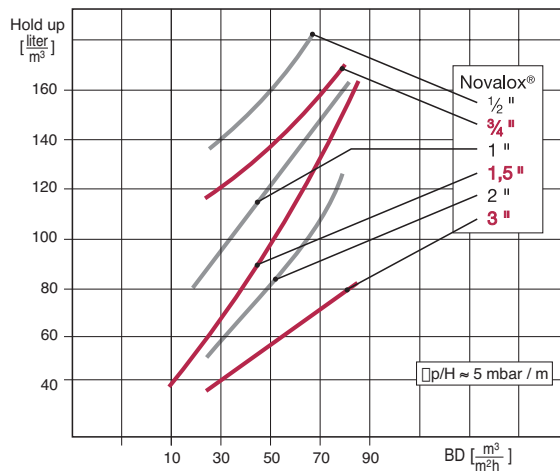

### K<sub>G</sub>a values

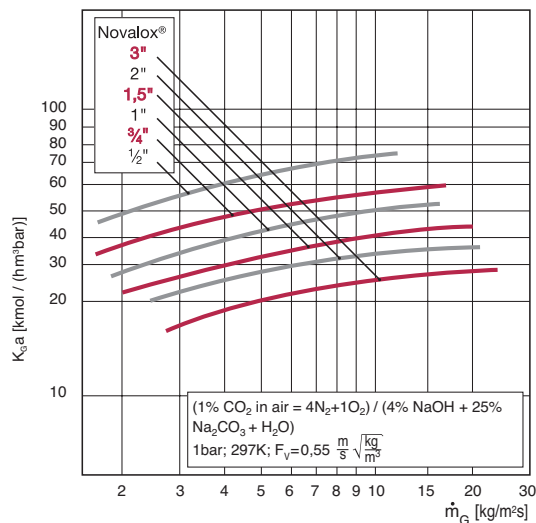

### Information for process engineering

Parameter	Remarks
D : d	> 10 : 1
F	$F = F(D/d)$ ; $F_{max} = 1,12$
BV	$BV = F * H * (D/2)^2 * \pi$
H <sub>min</sub>	1
H <sub>max</sub> (1 Bed)	3*D ... 8*D, max ca. 6 m
F <sub>v</sub>	0,1 ... 4 (BD = 0; BD > 0)
BD	3 ... > 100
Δp/H	0,1 ... 10
FF	20 ... 80 (a)
Hold-up	10 ... 150
HTU	0,1 ... 1 (b)
nth / H	0,7 ... 2 (b)

#### Abbreviations:

BD [m³/(m²·h)]:	Irrigation load
BV [m³]:	Tower packing's ordering volume
D [mm]:	Column diameter
d [mm]:	Random Packing's nominal size
F [-]:	Factor for the calc. of BV incl. the compulsory volume supplement (-> data sheet: TB01)
FF [%]:	Flooding factor
F <sub>v</sub> [(m/s) * √kg/m³]:	Gas loading factor
H [m]:	Bed height of the Random Packings
Hold-up [L/m³]:	Liquid hold up
HTU [m]:	Height of one transition unit
min/max:	Minimum / maximum
nth/H [1/m]:	Separation factor per unit height
Δp/H [mbar/m]:	Specific pressure drop
(a): FF>65%:	Please use multi beam support plate
(b):	Please consider minimum requirements for liquid or gas distributor and evt. aerosol problems.

### Pressure Drop

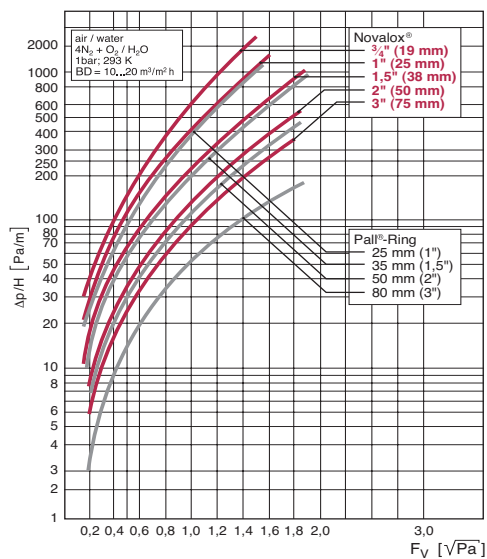

### Materials of VFF-Random Packings made of ceramic:

- ACIDUR®-Special Stoneware
- Chem. Techn. Porcelain
- Sicafill®
- Al<sub>2</sub>O<sub>3</sub>
- Glazed forms
- Special Ceramic

### Physical-chemical properties Average values of ACIDUR® Special Stoneware

SiO <sub>2</sub>	~ 70 %	Specific density	~ 2,3 g/cm <sup>3</sup>
Al <sub>2</sub> O <sub>3</sub>	min. 20 %	Acid resistance (DIN 51102)	~ 99 %
Fe <sub>2</sub> O <sub>3</sub> + TiO <sub>2</sub>	~ 2-3 %	Resist. against alkalines (DIN 51103)	~ 95 %
K <sub>2</sub> O + Na <sub>2</sub> O	~ 2,5-3,5 %	BET surface area	< 0,1 m <sup>2</sup> /g
MgO + CaO	~ 0,5-1 %		



## RANDOM PACKINGS MADE OF METAL

VFF tower packings have been used worldwide for many decades in a large variety of absorption, desorption, distillation and extraction processes, including applications in gas purification, water treatment and product purification.

A wide range of all important packing shapes and sizes are manufactured in the VFF production facilities. Raw materials and manufacturing are subject to continual, strict controls within the framework of the VFF operational quality assurance and external counterchecks.

In column filling, a cone shape and a high compaction of the tower packings is to be avoided,

any filling of the packings should take place on a wide, stable support plate.

Upon request, VFF will conduct a theoretical calculation of the column basic design based on the disclosing of the operational conditions.

This concerns the hydraulics and mass transfer, whereby VFF has chosen the optimal packing. For this, please see page e.g. 12 and 40.

With the VFF packing software, the column basic design can be calculated on a theoretical basis, including column diameter, bed height etc.







**Cylindrical Ring**

▶ 15-50 mm



**Pall®-Ring**

▶ 15, 25, 38, 50, 80, 90 mm



**VSP®**

▶ 25, 40, 50 mm



**Interpack®**

▶ Nr. 1, 2, 3



**Top-Pak®**

▶ Nr. 2



**Novalox®-M**



▶ 15, 25, 40, 50, 60, 70 mm

Description	Remarks / Comparison to Other Packings
Cyl. Ring	Cylindrical Ring: the simplest packing shape
Pall®-Ring	Approved for years, standard packing; applicable for all separation processes; approved properties for pressure drop, packing height, good mechanical stability and moderate pollution susceptibility.
VSP®	High performance tower packing; compared to Pall®-Ring: lower pressure drop without increase in packing height
Interpack®	Patent Rein-Linde; for small quantities, lower price than Pall®-Ring; comparable properties to Pall®-Ring
Top-Pak®	As a result of the spherical shape, the liquid distribution is more uniform, even with lower irrigation density and higher packing height, beneficial, moderate pollution susceptibility and simpler draining from the column even in a heavily polluted condition; favorable degree of separation with low pressure drop.
Novalox®-M	A metal tower packing saddle with good mass transfer
VFF-Twin-Pak®	VFF Patent. A modern high-performance metal tower packing with best mass transfer and extremely low pressure drop (see page 20)
Special shapes	Upon request and in coordination with the VFF customer

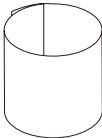
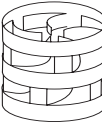
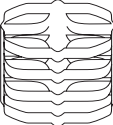
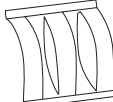
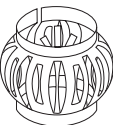

# RANDOM PACKINGS MADE OF METAL

## Physical properties

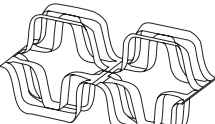
Description	Nominal size	Spec. weight* [kg/m <sup>3</sup> ]	Spec. surface [m <sup>2</sup> /m <sup>3</sup> ]	Free volume [%]
<b>Cylindrical Ring</b> 	15 mm	380	360	95
	25 mm	360	210	95
	38 mm	250	136	96
	50 mm	190	105	97
<b>Pall®-Ring</b> 	15 mm	380	360	95
	25 mm	360	210	95
	38 mm	250	136	96
	50 mm	190	105	97
	80 mm	200	80	96
	90 mm	185	65	98
<b>VSP®</b> 	25 mm	180	205	98
	40 mm	170	132	98
	50 mm	190	110	98
<b>Interpack®</b> 	#1 (10 mm)	600	620	92
	#2 (15 mm)	360	360	96
	#3 (20 mm)	380	260	96
<b>Top-Pak®</b> 	#2	160	80	98
<b>Novalox®-M</b> 	15 mm	360	290	96
	25 mm	340	230	97
	40 mm	230	150	98
	50 mm	160	100	98
	60 mm	140	85	98
	70 mm	120	60	98
<b>VFF-Twin-Pak®</b> 	No. 1	200	200	97
	No. 1,25	170	160	98
	No. 1,5	150	135	98
	No. 2	150	100	98
	No. 3	140	80	98

Additional sizes upon request

\* for 1.4301 and standard wall thickness

### Height of one Transfer Unit (HTU)

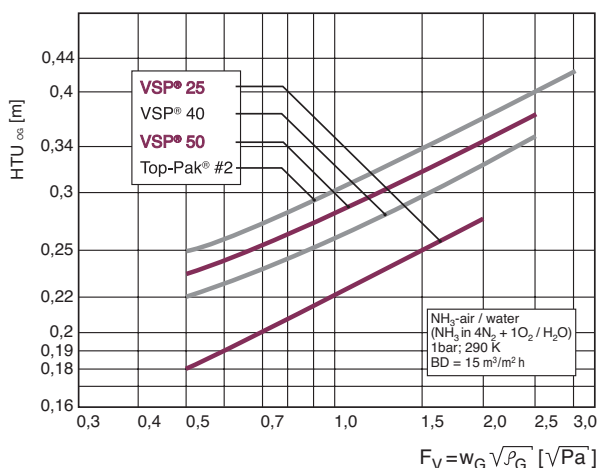

### Pressure drop

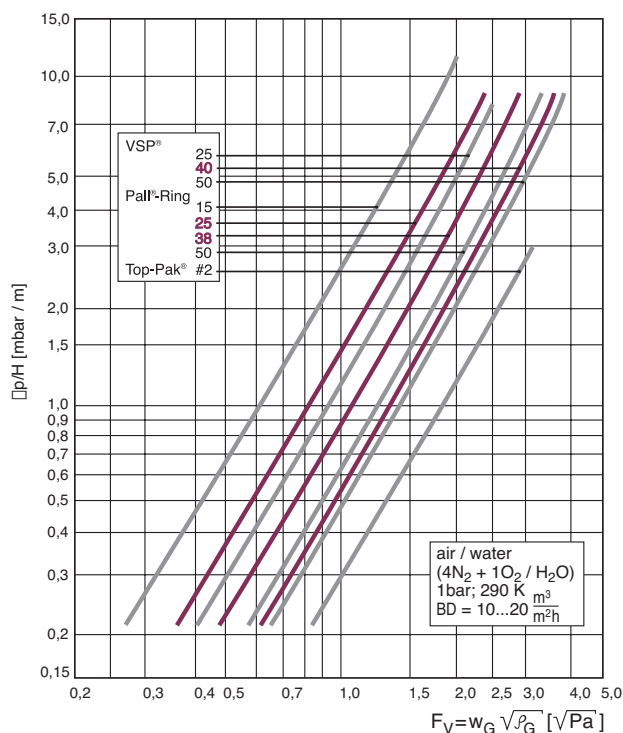

### Information for process engineering

Parameter	Remarks
D : d	> 10 : 1
F	$F = F(D/d)$ ; Fmax = 1,12
BV	$BV = F * H * (D/2)^2 * \pi$
Hmin	1
Hmax (1 Bed)	5*D ... 10*D, max ca. 10 m
Fv	0,2 ... 4
BD	3 ... > 100
Δp/H	0,1 ... 10
FF	20 ... 80 (a)
Hold-up	10 ... 150
HTU	0,1 ... 1 (b)
nth / H	1,5 ... 2,5 (b)

#### Abbreviations:

BD [m³/(m²h)]: Irrigation load  
 BV [m³]: Tower packing's ordering volume  
 D [mm]: Column diameter  
 d [mm]: Random Packing's nominal size  
 F [-]: Factor for the calc. of BV incl. the compulsory volume supplement (-> data sheet: TB01)  
 FF [%]: Flooding factor  
 Fv [(m/s) \* √kg/m³]: Gas loading factor  
 H [m]: Bed height of the Random Packings  
 Hold-up [L/m³]: Liquid hold up  
 HTU [m]: Height of one transition unit  
 min/max: Minimum / maximum  
 nth/H [1/m]: Separation factor per unit height  
 Δp/H [mbar/m]: Specific pressure drop  
 (a): FF>65%:  
 (b): Please use multi beam support plate  
 Please consider minimum requirements for liquid or gas distributor and evt. aerosol problems.

### Separation efficiency

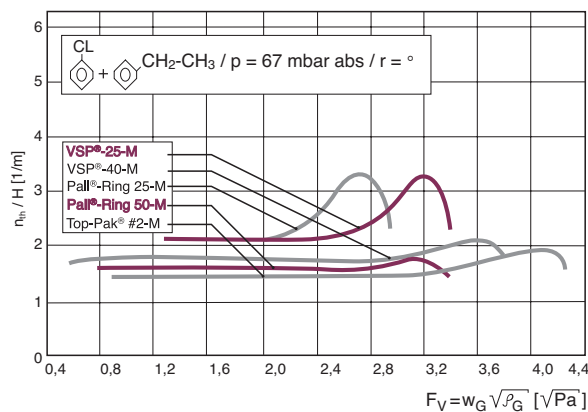

### Materials for VFF-Random Packings made of metal

- Carbon steel
- Stainless steel
- Aluminum
- Hastelloy
- Incoloy
- Inconel
- Copper
- Nickel
- Monel
- and others



## VFF-Twin-Pak®

### ► New Random Packing made of metal

The VFF-Twin-Pak®, a VFF-patent, is an entirely newly developed high-performance metal tower packing with a profile that comes close to the structured packings, while not doing without the numerous advantages of a tower packing. Its form combines an extremely low pressure drop with a convincing mass transfer!

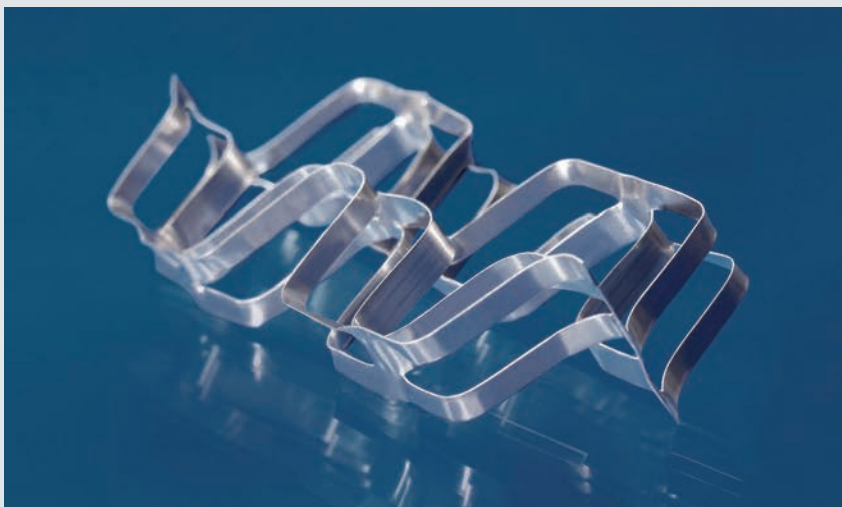

The VFF-Twin-Pak® is a high-performance tower packing, predestined for highest capacity. The mass transfer of the new VFF-Twin-Pak® is superior to that of a proven tower packing of an equivalent nominal size.

The specific pressure drop of the VFF-Twin-Pak® is much lower than that of the comparable tower packing.

In other words: The VFF-Twin-Pak® offers highest capacity while clearly saving costs!

By means of the new manufacturing method developed by VFF and its special design, the VFF-Twin-Pak® can convince by a high degree of design-related mechanical stability. This allows the trouble-free realization of a great filling height in a single bed at a low weight.

When the VFF-Twin-Pak® was designed, priority was placed on the demands of the VFF customers on a high-performance tower packing. Therefore, when it came to the manufacturing method, attention was paid that the customer is provided with a tower packing individually tailored to his requirements.

The VFF-Twin-Pak® is not only offered in a generally applicable standard version, but also with a multitude of options in regards to material or wall thicknesses. Whether as a featherweight or extremely strong version, whether carbon steel or special alloys – with the VFF-Twin-Pak®, the customer always receives the tower packing that is perfectly suited to his application.

The VFF-Twin-Pak® is individually available from 0.2 mm to 0.6 mm or in the standard wall thicknesses. An advantage that also pays off for all customers!

For further information please visit our website: [www.vff.com](http://www.vff.com)

dp/H: VFF-Twin-Pak® No. 2 vs. Pall-50-M

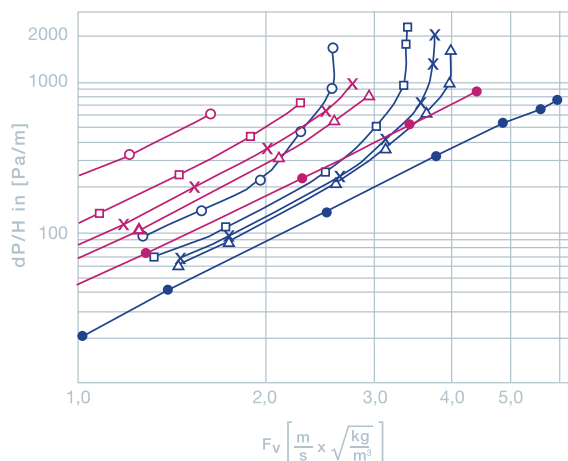

- |                            |                   |
|----------------------------|-------------------|
| <b>VFF-Twin-Pak® No. 2</b> | <b>Pall-50-M</b>  |
| ● uL = 0 m³/m²h            | ● uL = 0 m³/m²h   |
| ▲ uL = 30 m³/m²h           | ▲ uL = 30 m³/m²h  |
| × uL = 40 m³/m²h           | × uL = 40 m³/m²h  |
| □ uL = 60 m³/m²h           | □ uL = 60 m³/m²h  |
| ○ uL = 100 m³/m²h          | ○ uL = 100 m³/m²h |

HTU: VFF-Twin-Pak® No. 2 vs. Pall-50-M

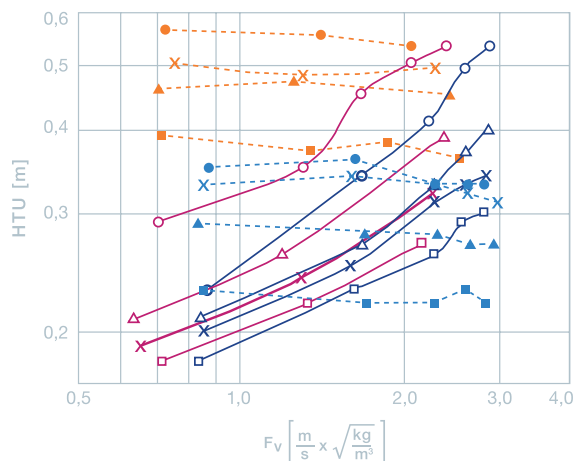

- |   |   |
|---|---|
| <b>VFF-Twin-Pak® No. 2 / HTUov-NH<sub>3</sub></b> | <b>VFF-Twin-Pak® No. 2 / HTUoL-CO<sub>2</sub></b> |
| ○ uL = 10 m³/m²h                                  | ○ uL = 10 m³/m²h                                  |
| ▲ uL = 20 m³/m²h                                  | ▲ uL = 20 m³/m²h                                  |
| × uL = 30 m³/m²h                                  | × uL = 30 m³/m²h                                  |
| □ uL = 40 m³/m²h                                  | □ uL = 40 m³/m²h                                  |
| <b>Pall-50-M / HTUov-NH<sub>3</sub></b>           | <b>Pall-50-M / HTUoL-CO<sub>2</sub></b>           |
| ○ uL = 10 m³/m²h                                  | ○ uL = 10 m³/m²h                                  |
| ▲ uL = 20 m³/m²h                                  | ▲ uL = 20 m³/m²h                                  |
| × uL = 30 m³/m²h                                  | × uL = 30 m³/m²h                                  |
| □ uL = 40 m³/m²h                                  | □ uL = 40 m³/m²h                                  |

Physical properties VFF-Twin-Pak®

Nominal size	Spec. weight [kg/m³]	Spec. surface [m²/m³]	Free volume [%]
No. 1	200	200	97
No. 1,25	170	160	98
No. 1,5	150	135	98
No. 2	150	100	98
No. 3	140	80	98



VFF-Twin-Pak® (Patent VFF)  
 ▶ No. 1, No. 1,25, No. 1,5, No. 2, No. 3

Brochure „VFF-Twin-Pak®“

The brochure can be downloaded under [www.vff.com](http://www.vff.com) or requested at VFF!





# RANDOM PACKINGS MADE OF PLASTIC

VFF tower packings have been used worldwide for many decades in a large variety of absorption, desorption, distillation and extraction processes, including applications in gas purification, water treatment and product purification.

A wide range of all important packing shapes and sizes are manufactured in the VFF production facilities.

Raw materials and manufacturing are subject to continual, strict controls within the framework of the VFF operational quality assurance and external counterchecks.

In comparison to the traditional hydrophobic packing materials, VFF plastic packings stand out due to their special raised surface,

which ensures exceptional moistening immediately with the first application.

In column filling, a cone shape and a high compaction of the packings is to be avoided, any filling of the packings should take place on a wide, stable support plate.

Upon request, VFF will conduct a theoretical calculation of the column basic design based on the disclosing of the operational conditions. This concerns the

hydraulics and mass transfer, whereby VFF has chosen the optimal packing material. For this, please see page e.g. 12 and 40.

With the VFF packing software, the column basic design can be calculated on a theoretical basis, including column diameter, bed height etc.





**Novalox®-Saddle**

▶ 1½", 2"



**Pall®-Ring**

▶ 15, 25, 38, 50, 90 mm

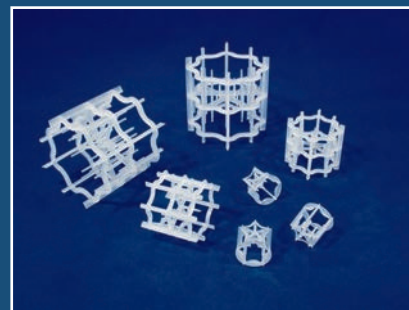

**VSP®**

▶ 25, 50, 90 mm



**Igel®**

▶ 40 mm



**VFF-NetBall®**

▶ 45, 90 mm



**VSP®-V**





▶ 50 mm

Description	Remarks / Comparison to Other Packings
Novalox®-Saddle	Similar properties in relation to the Pall®-Ring
Pall®-V-Ring	Improved design compared to Pall®-Ring; approved for years, standard packing; applicable for all separation processes; approved properties for pressure drop, packing height, good mechanical stability and moderate pollution susceptibility.
VSP®	High-performance tower packing; lowest pressure drop
Igel®	Patent Ciba-Geigy; lowest packing height, but only with clean media
VFF-NetBall® (see page 26)	Special designed high performance tower packing with a high specific surface and a low pressure drop; because of the spherical shape the liquid distribution is more even in relation to other tower packings even for low irrigation densities and high bed heights; moderate pollution susceptibility; simple discharge out of a column even for heavy pollution;
Special shapes	Upon request and in coordination with the VFF customer

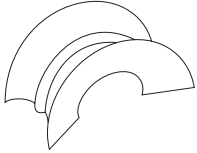
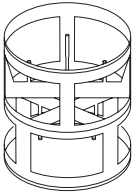

# RANDOM PACKINGS MADE OF PLASTIC

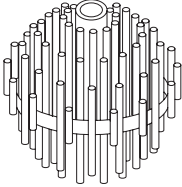
## Physical properties

Description	Nominal size [mm]	Spec. weight* [kg/m <sup>3</sup> ] (*PP)	Spec. surface [m <sup>2</sup> /m <sup>3</sup> ]	Free volume [%]
<b>Novalox®- Saddle</b> 	38	80	170	91
	50	75	120	92
<b>Pall®-Ring</b> 	15	80	350	91
	25	80	220	91
	38	60	145	93
	50	45	110	95
	90	60	78	93
<b>VSP®</b> 	25	60	185	93
	50	45	100	95
	90	30	78	97
<b>VSP®-V</b> 	50	47	100	95
<b>Igel®</b> 	40	120	300	87
<b>VFF-NetBall®</b> 	45	42	140	95
	90	41	130	95

### Materials for VFF-Random Packings made of plastic

#### Standard:

- PE
- PP
- PVDF
- ECTFE

#### Upon request:

- PVC
- PFA, etc.

Carbon endowment

Electric conductivity



### Height of one Transfer Unit (HTU)

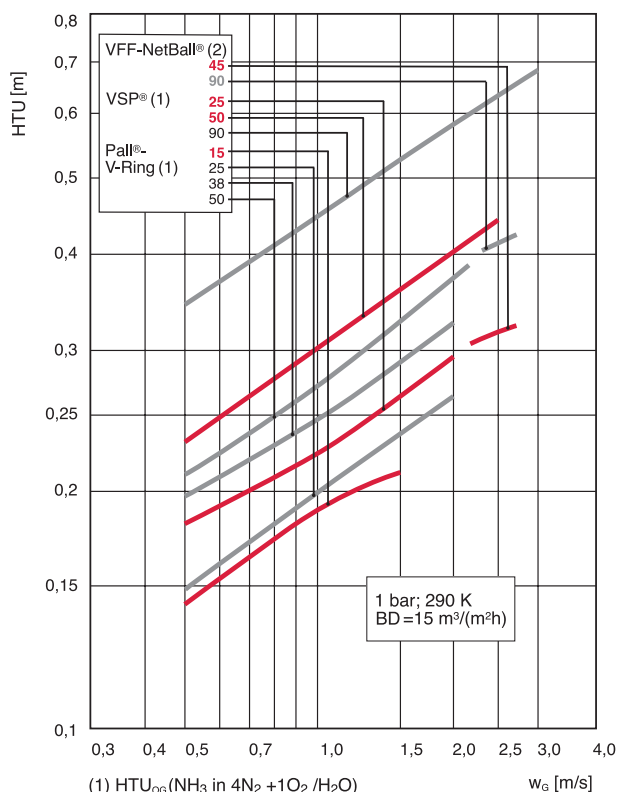

### Pressure drop

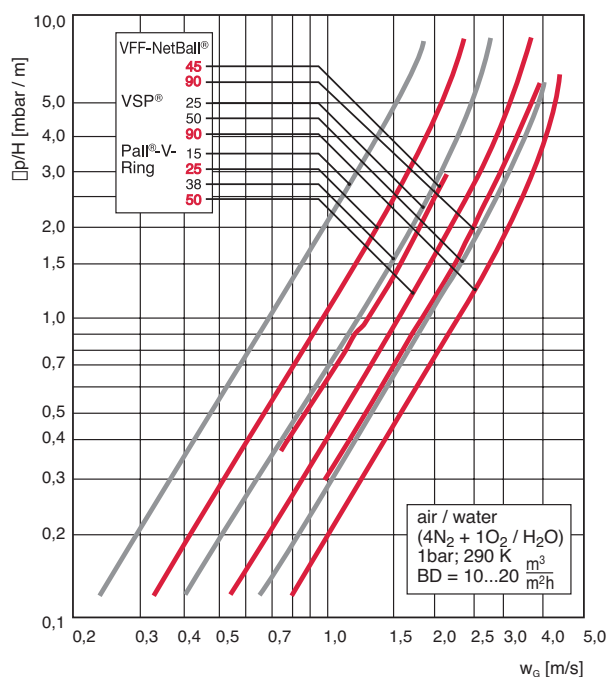

### Information for process engineering

Parameter	Remarks
D : d	> 10 : 1
F	$F = F(D/d)$ ; $F_{max} = 1,12$
BV	$BV = F * H * (D/2)^2 * \pi$
Hmin	1
Hmax (1 Bed)	$5 * D \dots 10 * D$ , max. 10 m
Fv	0,2 ... 4
BD	3 ... > 100
$\Delta p/H$	0,1 ... 10
FF	20 ... 80 (a)
Hold-up	10 ... 150
HTU	0,1 ... 1 (b)
nth / H	1,5 ... 2,5 (b)

#### Abbreviations:

BD [ $m^3/(m^2 \cdot h)$ ]:	Irrigation load
BV [ $m^3$ ]:	Tower packing's ordering volume
D [mm]:	Column diameter
d [mm]:	Random Packing's nominal size
F [-]:	Factor for the calc. of BV incl. the compulsory volume supplement (-> data sheet: TB01)
FF [%]:	Flooding factor
$F_v [(m/s) * \sqrt{kg/m^3}]$ :	Gas loading factor
H [m]:	Bed height of the Random Packings
Hold-up [ $L/m^3$ ]:	Liquid hold up
HTU [m]:	Height of one transition unit
min/max:	Minimum / maximum
nth/H [1/m]:	Separation factor per unit height
$\Delta p/H$ [mbar/m]:	Specific pressure drop
(a): FF > 65%:	Please use multi beam support plate
(b):	Please consider minimum requirements for liquid or gas distributor and evt. aerosol problems.





## VFF-NetBall®

VFF-NetBall® – High performance for absorption and desorption:

VFF carried out active research and development to create the new VFF-NetBall®.



This high performance random packing is setting now new standards. Its favorable flow profile, combined with a high specific surface, offers top mass transfer properties with an extremely high hydraulic load capacity and the lowest pressure drop.

Like all our VFF Random Packings made of plastic, the VFF-NetBall® is equipped with a special abraded surface, that creates a very good wetting already with the first application. Its specially designed net structure guarantees, in addition, a high mechanical stability and leads to an ideal constitution in the bed.

The VFF-NetBall® provides simple handling during the column filling and emptying. All this, saves time and money!

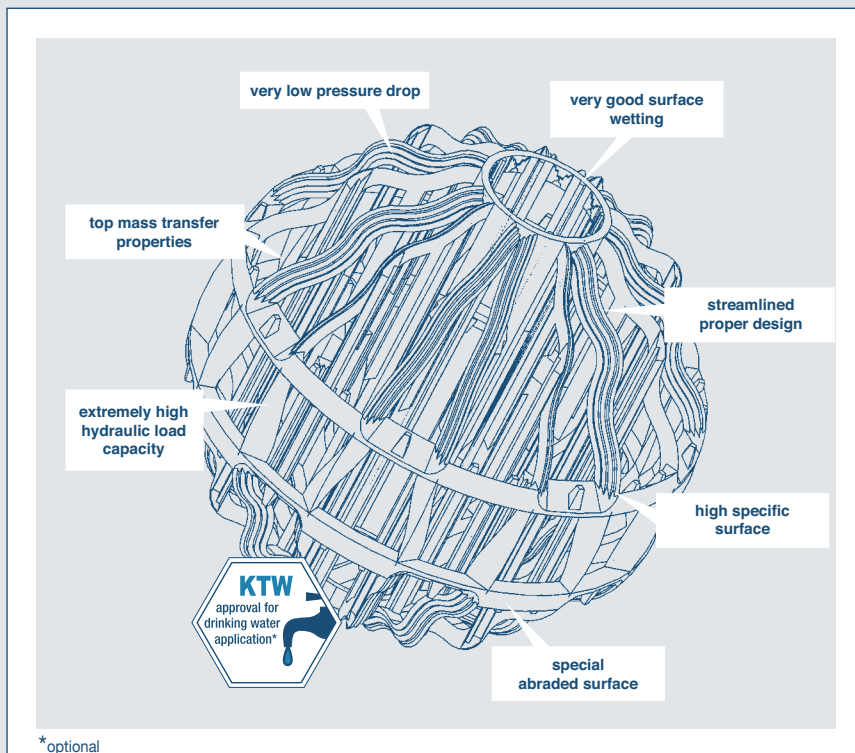

Pressure drop diagram: VFF-NetBall®-90-P

Water/Air: 1 bar; 20°C  
 Dp/H: specific pressure drop  
 uL: irrigation density

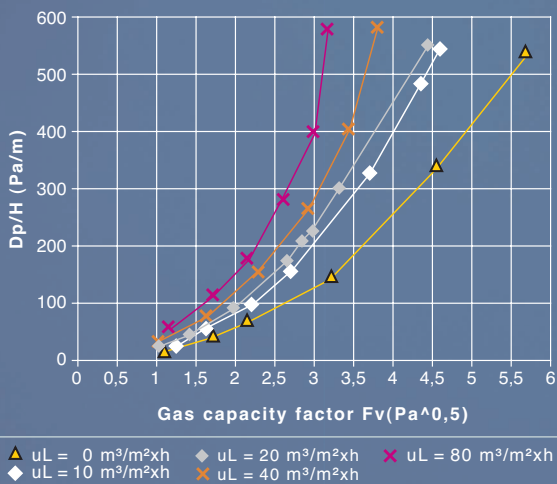

Pressure drop diagram: VFF-NetBall®-45-P

Water/Air: 1 bar; 20°C  
 Dp/H: specific pressure drop  
 uL: irrigation density

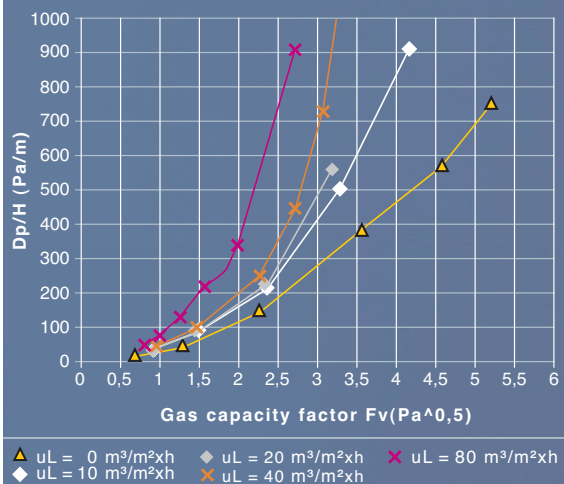

**Physical properties** (Materials: PP, PE, PVDF, further materials upon request)

Description	Nominal size [inch]	Spec. weight [kg/m³] (PP)	Spec. weight [kg/m³] (PE/PVDF)	Spec. surface [m²/m³]	Free volume [%]
VFF-NetBall-90®-P	3 1/2	41	42 / 80	130	95
VFF-NetBall-45®-P	2	42	43 / 82	140	95



VFF-NetBall®  
 ▶ 45, 90 mm

**Brochure „VFF-NetBall®“**

The brochure can be downloaded under [www.vff.com](http://www.vff.com) or requested at VFF!

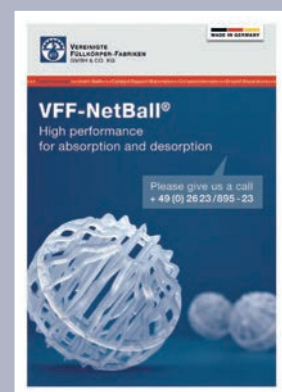



## SUPPORT PLATES, GRIDS

In mass separation and heat transfer processes, a sufficiently homogeneous distribution of the liquid and/or gaseous phase over the whole column cross area plays an important role, because the total bed height is only then available for the process itself.

VFF support plates and grids in various design forms and with various supporting substructures carry the weight of the packing as well as that of the liquid-hold-up from contamination during operations.

They have to supply a sufficient open area, so that the gaseous and liquid phase can penetrate through and drain off sufficiently without obstruction.

Depending on the hydraulic load of the column, relatively simple and inexpensive grid forms or more

complicated multi beam support plates with larger free gas cross-section and with separately guided gas and liquid flow are available.

A wide range of ceramic, metallic and plastic materials, careful in-house construction / production and quality controls round off the VFF performance profile in this area.

VFF is able to advise you, verify the hydraulic column operation for you by means of calculations and will conduct the necessary mechanical stability calculations.

In addition, you will be briefed by VFF regarding which support rings or support beams are necessary and which weights from VFF internals in the column operations have an effect on the column wall.

Upon special request, VFF will also draw vessel sketches. With decades of experience in the various fields of application for absorption, desorption, distillation, water treatment and adsorption, VFF offers their customers optimal performance and service.

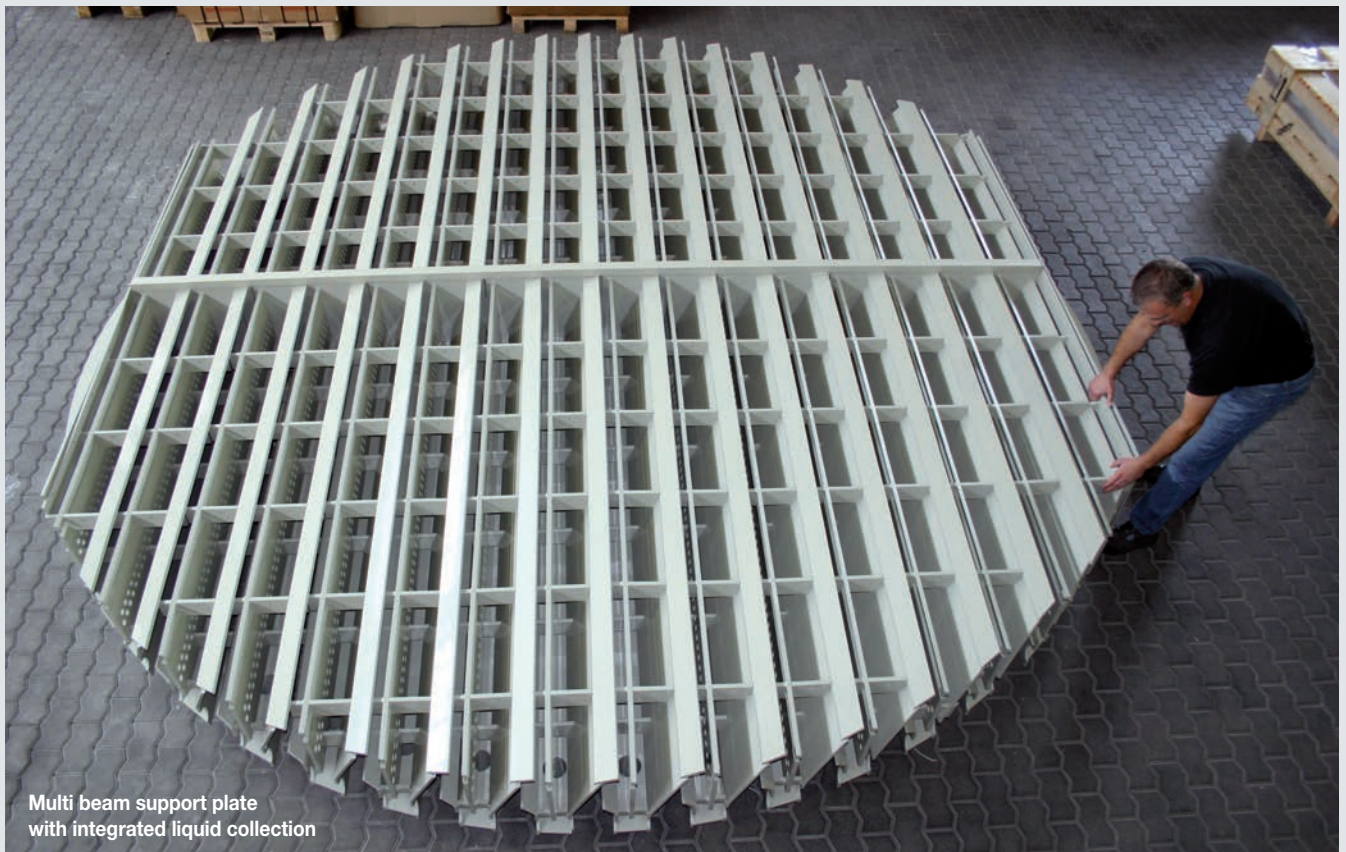

Multi beam support plate  
with integrated liquid collection

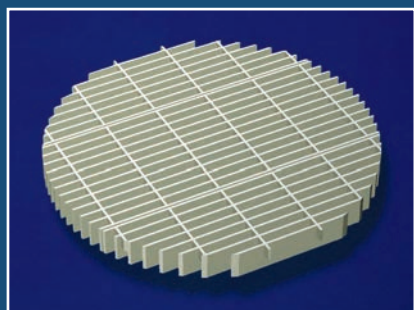

AU-02-P



AU-03-K

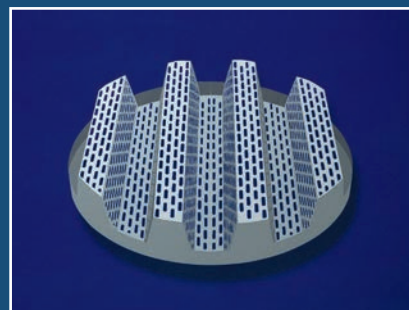

AU-03-M



AU-04-K



AU-05-K



AU-06-K

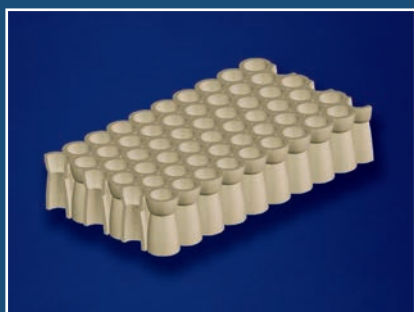

AU-07-K

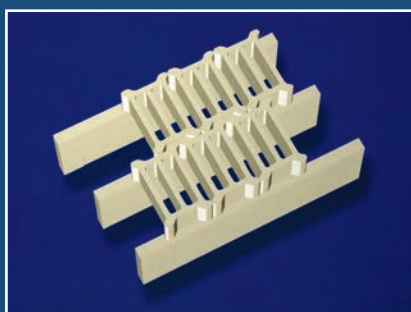

AU-08-K

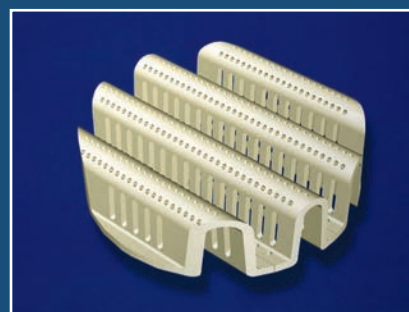

AU-10-K



AU-10-M









FSA-10-P

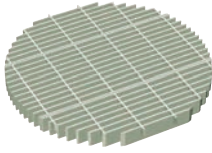
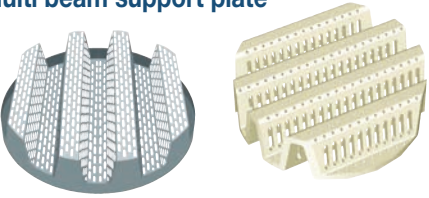

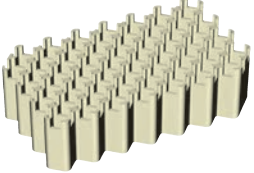
# SUPPORT PLATES, GRIDS

Depending on the material and wall thickness, type, and supporting structure, VFF's support plates and grids can carry loads ranging from a few hundred kg/m<sup>2</sup> up to more than 10 to/m<sup>2</sup>. The following table lists some of those types available.

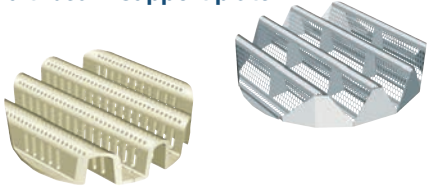
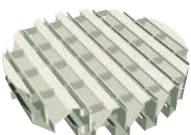
Description	Type	min. ... max. D [m]	A(f) [%]	min NA [mm]	Remarks
<b>Support grid</b> 	<b>AU-02-M, P</b>	> 0,1	75	25 (10)	Very inexpensive, Single or multisectional; Operation above 65 % of the flooding point should be avoided. Standard design for metal or plastic materials.
<b>Multi beam support plate</b> 	<b>AU-03-K, M, P</b>	< 1,2	35...85	25 (15)	Trapezoidal profiles with slits and holes, separated liquid and gas flow.
<b>Braun's support grid</b> 	<b>AU-04-K</b>	> 0,25	> 50	50 (25)	Standard elements: 500 mm x 300 mm, height approx. 100 mm; carrying substructure required with minimum support width of 100 mm.
<b>VFF-Grid</b> 	<b>AU-05-K</b>	> 0,25	> 70	50	Standard elements: 500 mm x 300 mm, height approx. 100 mm; carrying substructure required with minimum support width of 100 mm.
<b>VFF-Super-Grid</b> 	<b>AU-06-K</b>	> 0,25	> 70	50 (25*)	Standard elements: 500 mm x 300 mm, height approx. 155 mm; carrying substructure required with minimum support width of 100 mm; reduced pressure drop; *) if used with sand-wiched transitional grid linings.
<b>Venturi-Grid</b> 	<b>AU-07-K</b>	> 0,25	> 20 (50)	50 (25)	Standard elements: 500 mm x 300 mm, height approx. 100 mm; carrying substructure required with minimum support width of 100 mm.

Description	Type	min. ... max. D [m]	A(f) [%]	min NA [mm]	Remarks
<b>Multi beam support plate</b> 	<b>AU-10-K, M, P</b>	> 1,0	35... > 100	25	Single profiles, separated liquid and gas flow, recommended for operations above 65 % of the flooding point
<b>Combined collector- and support plate</b> 	<b>FSA-10-P</b>	> 2,0	> 50	25	Standard profile approx. 2 x 250 mm wide; liquid leakage rate approx. 10 litres / (m <sup>2</sup> x h)
<b>Transitional grid linings: Cyl. Rings without / with partitions; Grid Block</b>					see pp. 13, 14
<b>Cross Partition Ring</b> 	<b>K/ZSt-4</b>	> 0,2	50	25... > 50	Nominal sizes (in mm): 50 / 80 / 100 / 120 / 150 / 200, with either one or two partitions; carrying substructure required
<b>Hold down grid</b> 	<b>RH-03-M, P</b>	> 0,1	75	25 (10)	Grating, either single or multi-sectional
<b>Special designs</b>					Modification in wall thickness, height etc.

### Materials of VFF-Support plates and grids

#### Ceramic:

- ACIDUR®-special stone ware
- and others

#### Metal:

- Carbon steel
- Stainless steel
- Alloys
- and others

#### Plastic:

- PE
- PP
- PVC
- C-PVC
- and others
- PVDF
- PTFE

All information for standard designs in approximate values.

min...max D: minimal...maximum column diameter

A(f): Free cross area for the gas flow in relation to the entire column cross-section

min. NA: Minimal size of a cylindrical shaped tower packing

K: Ceramic

M: Metal

P: Plastic



# LIQUID DISTRIBUTORS / COLLECTORS

Liquid distributors or redistributors should be selected according to the type of packing used and the operating conditions.

Among others, the following should be taken into consideration:

- Turn-down ratio
- Column diameter
- Corrosiveness
- Desired efficiency of separation
- Irrigation load
- Distribution exactness
- Viscosity of the liquid

- Particle concentration or all sludge content in the liquid
- Polymerizing components
- Temperatures

The turn-down ratio can be influenced to a relatively wide extent by the design and location of the drainage openings, e.g. multiple holes on top of each other in the sidewall

(or inner tube) or slots of appropriate width or other design.

Special attention is to be paid to, among others, a minimum opening size, a minimum liquid level, an appropriate internal distributor current direction and an aligned distributor assembly.

A standard liquid distributor's turn-down-ratio depends on the necessary type; however, it is possible for each type to expand the turn-down-ratio to a range broader than 1 : 2.1



FL-03-M



FL-04-M

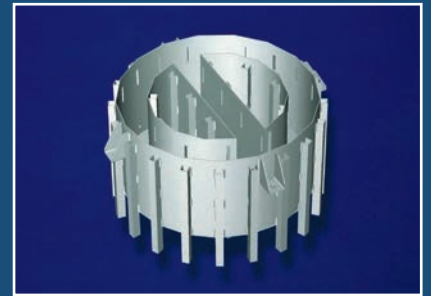

FL-05-M



FL-10-P

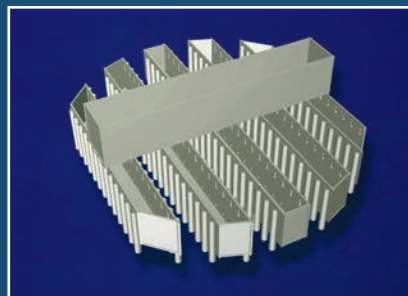

FL-20-P

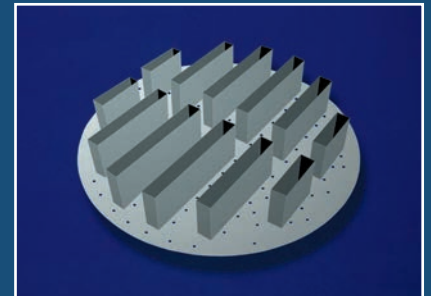

FL-30-M

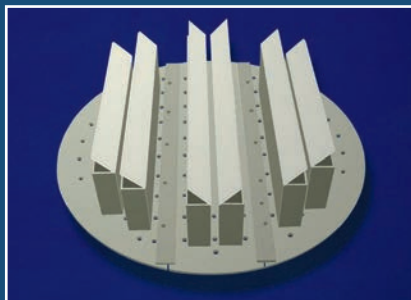

RV-30-P





RV-03-M



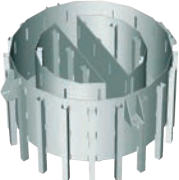

FL-50-P

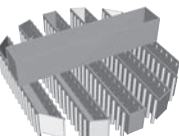

Description	Type	min. ... max. D [m]	max. Fv [Pa <sup>1/2</sup> ]	N(T) [1/m <sup>2</sup> ]	min. ... max. B [m/h]	AB	Remarks
<b>Weir riser-pan distributor</b> 	FL-03-K, M, P	0,4 ...1,2	1,1	20...65	2...30	1 : 7	Inexpensive, suitable also for very unclean liquids
<b>Orifice pan distributor</b> 	FL-04-M, P	0,4 ...1,2	2,5	65...160	1...150	1 : 2,1	Very reasonable, suitable for moderately unclean liquids, modification with built-in tubes
<b>Ring channel pan distributor with orifices and down pipes</b> 	FL-05-M, P	0,3 ...1,2	3,5	65...130	1...40	1 : 2,1 (1 : 10)	Recommended for column operations above 65 % of the flooding point; also suitable for moderately unclean liquids
<b>Trough distributor</b> 	FL-10-K, M, P	> 1	1,9	65...100	3...150	1 : 4 (1 : 7)	Inexpensive; several main distributors; suitable for clean and unclean liquids.
<b>Trough distributor with orifices and down pipes</b> 	FL-20-M, P	> 1	3,5	65...100	1...40	1 : 2,1 (1 : 10)	Recommended for column operations above 65 % of the flooding point; also suitable for moderately unclean liquids.
<b>Deck type distributor with gas risers</b> 	FL-30-M, P	> 0,8	2,5	100	2...100	1 : 2,1	Several main distributors; suitable for clean and moderately unclean liquids.

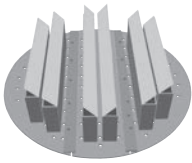

# LIQUID DISTRIBUTORS / COLLECTORS

Description	Type	min. ... max. D [m]	max. Fv [Pa <sup>1/2</sup> ]	N(T) [1/m <sup>2</sup> ]	min. ... max. B [m/h]	AB	Remarks
<b>Orifice deck redistributor with covers</b> 	<b>RV-30-M, P</b>	> 0,8	2,5	100	2...100	1 : 2,1	Suitable for clean and moderately unclean liquids
<b>Ladder pipe distributor</b> 	<b>FL-50-P</b>	> 0,9	4,5	65...120	10 ... 160	1 : 2	Suitable for clean and unclean liquids. Pre-pressure necessary (< 200 mbar)
<b>Special designs</b>		> 0,2	> 3,5	> 200	0,5 ... > 250	1 : > 10	Modification of the distributor e.g. larger turn-down, min / max. irrigation density, reduced fouling susceptibility, various distributor systems and versions, etc.

In general, all internals are designed with easy installation, adjustments and inspections in mind, e. g. internals can be accessed through man holes or the vessel's flanges.

## Materials of VFF-Liquid distributors / collectors

### Ceramic:

- ACIDUR®-special stone ware
- and others

### Metal:

- Carbon steel
- Stainless steel
- Alloys
- and others

### Plastic:

- PE
- PP
- PVC
- C-PVC

- PVDF
- PTFE
- PFA
- ECTFE
- and others

All information for standard designs in approximate values.

min...max D: minimal...maximum column diameter  
 max. Fv: Maximum gas loading factor  
 N(T): Number of drop points  
 min...max B: Minimum...Maximum irrigation density  
 AB: Turn down ratio  
 K: Ceramic; M: Metal; P: Plastic

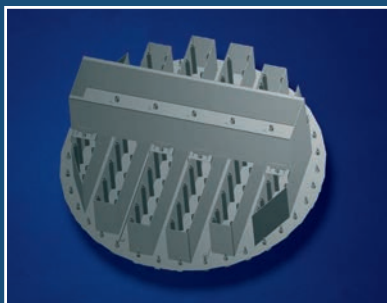

FL-32-M



FS-05-M

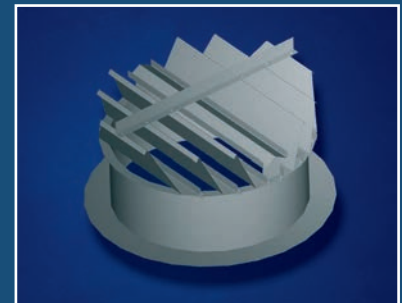

FS-10-M

# FEED DEVICES: GAS / LIQUID







A gas distributor is necessary amongst other things in the case of high kinetic energy in the gas inlet, small distances between the inlet and bed and for applications with a very low pressure drop of the tower packing bed.

The effort associated with the installation of a gas distributor is advisable for large column cross-sections, low gas-free pipe velocities, very low bed heights etc.

The distribution of the liquid at the bed entrance has considerable

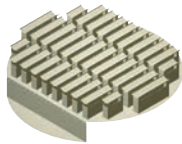
influence on the actual separation efficiency. A good starting distribution begins with a low-turbulence liquid feed. The inflow speed of an axial feed should lie in the range of 0.5 to 1.0 m/s depending on the requirement. An increase in this speed is possible when the

number of feed points of the feed device for the liquid is increased.

Discription	Type	min. ... max. D [m]	A(f) [%]	Remarks
<b>Gas distributor plate</b> 	<b>G-30-M, P</b>	> 0,8	< 15	Plate with covers on chimneys; liquid drain-off through regular hole pattern or drain-off pan; generates gas-side pressure drop; special design allows use as support plate.
<b>Gas sparger</b> 	<b>G-49-M, P</b>	< 2,0	> 80	Tube in the centre of the column with side holes or slots; gas exits downwards; easy and very inexpensive; generates minimum gas-side pressure drop; in case of large column diameter, also available as H-type-design.
<b>T-shaped feed device</b> 	<b>ZR-10-M, P</b>	> 1,2	> 90	Feed device for low level impulse feed of a main distribution trough of type FL-10 / 20 / 30 or similar.
<b>H-shaped feed device</b> 	<b>ZR-20-M, P</b>	> 2,5	> 90	Feed device for low level impulse feed of a main distribution trough; however for larger dimensions or higher quantities of two main distribution troughs.

All information for standard designs in approximate values

min...max D: minimal...maximum column diameter

A(f): Free cross area for the gas flow in relation to the entire column cross-section

M: Metal

P: Plastic



## DROPLET SEPARATORS (DEMISTER)

For many decades, VFF droplet separators have been successfully used in a large variety of applications and design forms – up to 18 m in diameter.

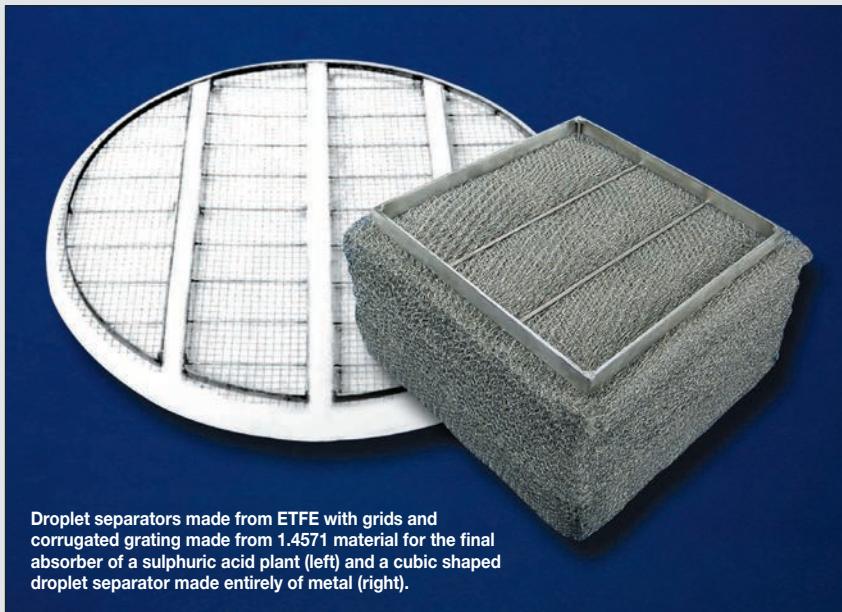

Droplet separators made from ETFE with grids and corrugated grating made from 1.4571 material for the final absorber of a sulphuric acid plant (left) and a cubic shaped droplet separator made entirely of metal (right).

Wire mesh droplet separators (Demister) are used for the removal of small liquid droplets (aerosols) from exhaust gases, exhaust air and steam.

VFF's portfolio includes a wide range of practical experience in the following applications and devices:

- Absorbers
- Seawater desalination equipment
- Washers
- Sulphuric acid plants
- Vacuum columns
- Sound absorbers
- Distillation and rectification plants
- Oil separators
- Evaporators, flash vessel systems
- Steam drums

During separation, the droplets enter the knitted wire mesh and collide with the wire surface due to their moment of gravity. The collected droplets coalesce at the cross points in the mesh and fall back as larger droplets into the vessel.

The separation efficiency, which is influenced by the void space and the specific wire mesh surface area, improves with increasing flow velocity. Due to flooding, the maximum flow velocity must not be exceeded, otherwise re-entrainment will occur.

The achievable limiting droplet size for 99.9% fractional separation efficiency is within a range of 5  $\mu\text{m}$  to 12  $\mu\text{m}$  for standard mesh types. By means of a special design and layout

of mesh types, limiting droplet downsizing to 3  $\mu\text{m}$  or less is possible.

As an integral part of our service, we offer our customers professional practical support for the material selection of the particular application, as well as configuration calculations for optimal operations and the best separation efficiency, while taking the primary influencing factors into consideration.

The wire mesh droplet separators are produced with thin wires in various mesh sizes, whereby a wire diameter in the range of 0.5 mm to 0.1 mm is typically used. The specific surface area of the mesh pad covers a range from approx. 150  $\text{m}^2/\text{m}^3$  to 1100  $\text{m}^2/\text{m}^3$ .

Typically, specially constructed supports and/or cover grids are delivered as support for the mesh pads, which are arranged so that the free inflow area is a minimum of 90%.

During the installation of the wire mesh, it must be ensured that the mesh pad is tightly fitted along the wall of the column, so that gas bypassing will not occur.

VFF offers a wide range of metallic materials and plastics as well as metal-plastic combinations, in order to be able to handle the temperature and/or corrosive conditions of the particular application, for example.

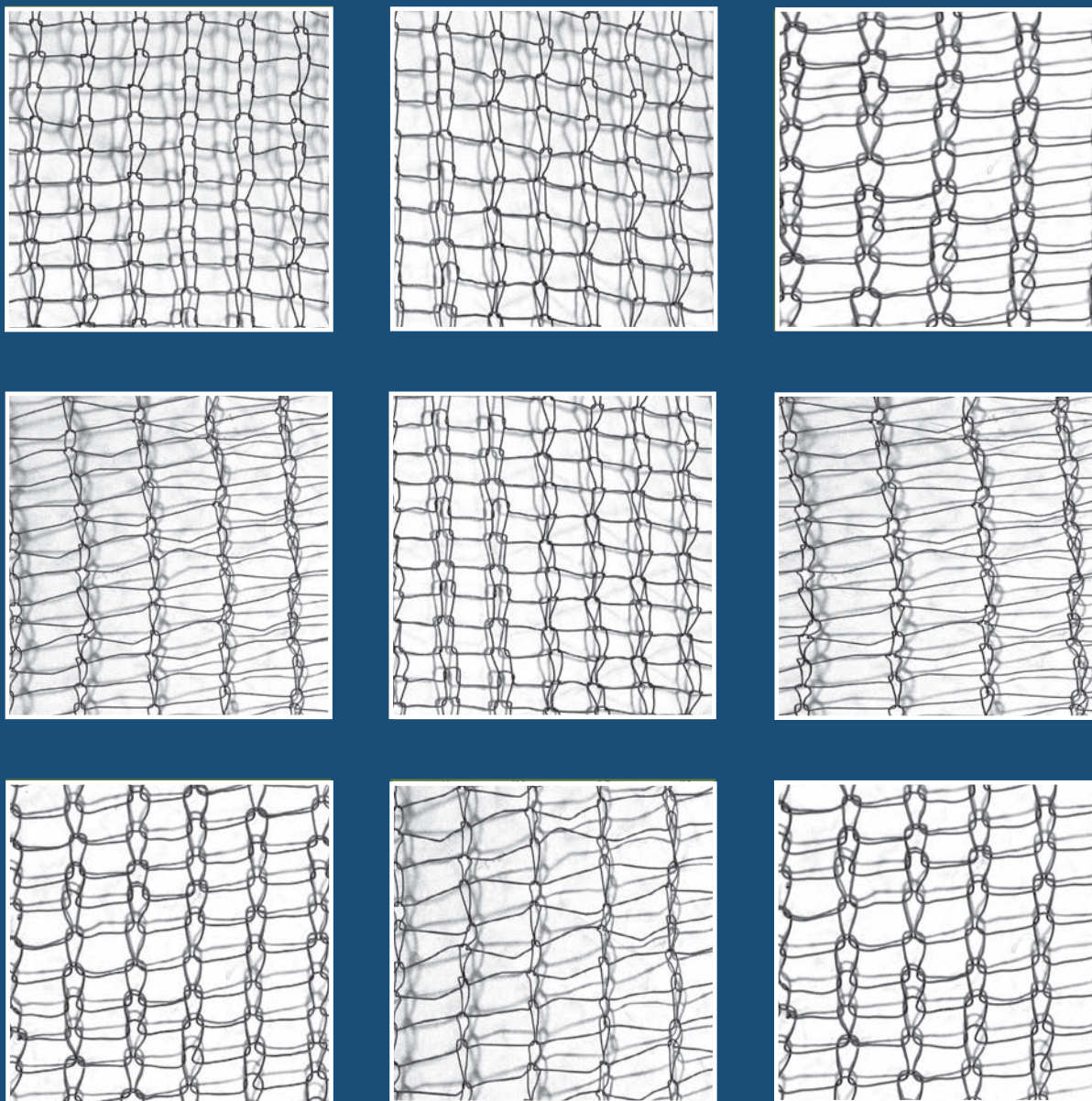

Examples of different droplet separator wire meshes.

The pad height of the wire mesh droplet separators is between 100 and 150 mm in most applications. If the gas or steam flow contains very fine

mist, such as that created during condensation, a considerably higher pad height or a multiple layer design may be necessary.



# DROPLET SEPARATORS (DEMISTER)

## Type selection

(Standard wire mesh form and width, as well as standard wire diameter)

VFF type	Spec. surface [m <sup>2</sup> /m <sup>3</sup> ] **	Spec. weight [kg/m <sup>3</sup> ]**	Free ** Volume [%]	Material	Design and application
T-01-M	150	Material: 1.4301: 80	99,0	1.4301	Standard types of metal with low to high packing density for almost all applications.
T-02-M *1	255	Material: 1.4301: 130	98,2	1.4541	
T-03-M	345	Material: 1.4301: 170	97,6	1.4571	
T-10-M	420	Material: 1.4301: 125	98,4	Monel	
T-20-M	510	Material: 1.4301: 150	98,1	Nickel	
T-30-M	590	Material: 1.4301: 175	97,8	Titan Tantal a. o.	
T-01-P *2	550	Material: PP: 50	94,5	PE	Standard plastic materials for aggressive media and temperatures up to 80 °C
T-02-P	880	Material: PP: 80	91,2	PP	
T-03-P	1100	Material: PP: 90	89,0	PVC a. o.	
T-10-P *3	550	Material: Hostaflon: 80	95,5	PFA	High-persistent plastics for very aggressive media and temperatures up to 180 °C
T-20-P	680	Material: Hostaflon: 100	94,4	ETFE (Hostaflon)	
T-30-P	890	Material: Hostaflon: 130	92,7	ECTFE (Halar) PVDF a. o.	
T-01-P-HT	750	Material: PP: 65	92,7	PP	These types are thermally pre-shrunk and can therefore be applied without considerable form changes to 80 °C or 140 °C, respectively.
T-10-P-HT	1000	Material: Hostaflon: 92	91,4	ETFE (Hostaflon)	
T-03-MP	560	Material combination: 1.4301/PP: 190	94	VA/PP	These types consist of mesh with different wire materials (stainless steel and plastic) and are used for coalescence.
T-10-MP	560	Material combination: 1.4301/Teflon: 150	94	VA/Teflon	

\*1 Standard type made from stainless steel for universal application in evaporators, distillers, rectification plants etc.

\*2 Standard type made from PP for universal application for air and gas washers

\*3 Standard type made from ETFE (Hostaflon, heavy construction) for the separation of droplets and mist in sulphuric acid plants

\*\*\*) All information is approximated and their limits may be varied upon customer's request.



### Pressure drop

Typical pressure drop curves of a droplet separator in dependence on various liquid loadings L

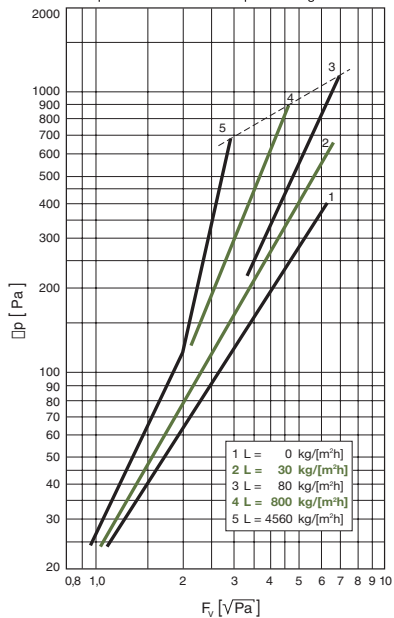

### Pressure drop

Curves (dry) of different droplet separators

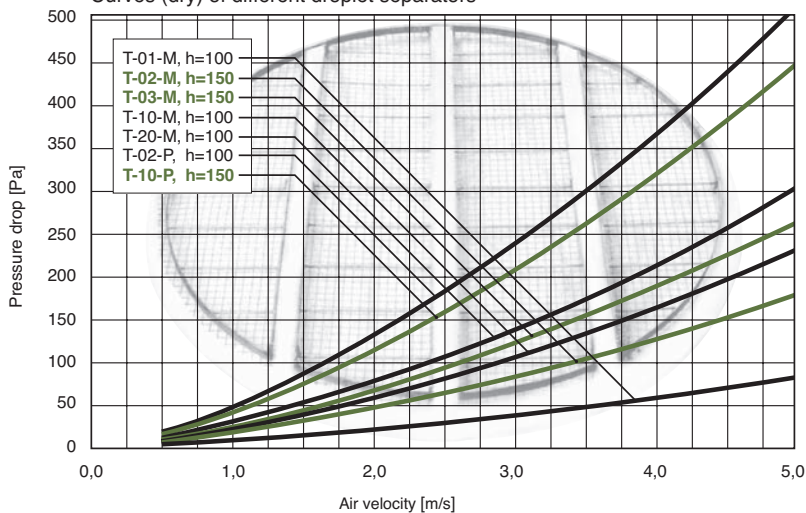

### Separation efficiency

T-02-M  
(d: droplet diameter)

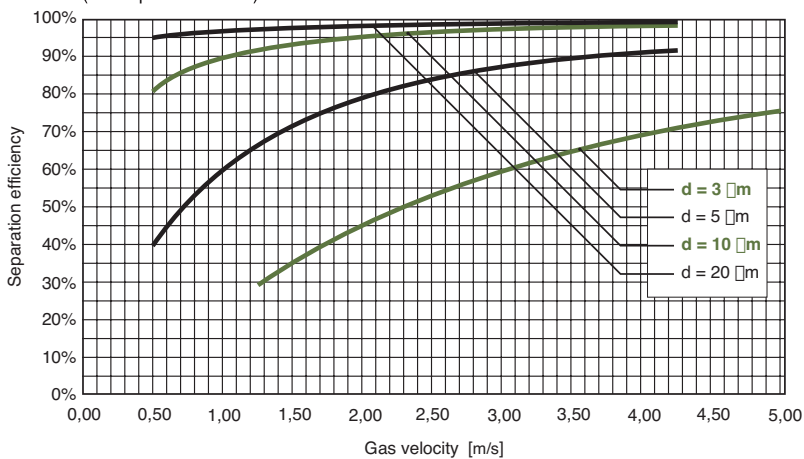

### Installation options

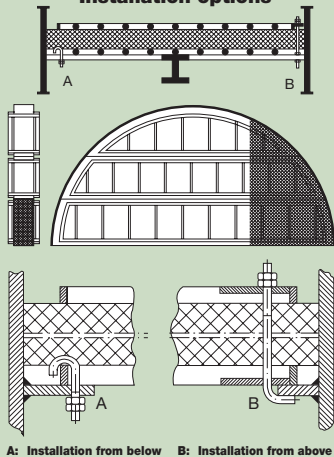

A: Installation from below B: Installation from above

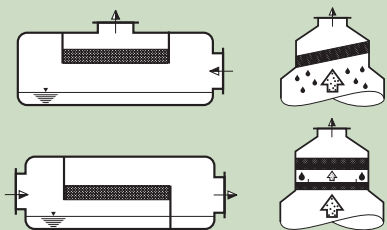

The appropriate angle  $\alpha$  depends on e. g. the flooding factor.

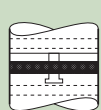

Separation



Agglomeration + separation





# VFF RANDOM PACKING SOFTWARE

VFF Random Packing Software for the calculation of column hydraulics, HTU and NTU values, absorption and stripping.

## System Requirements

- Operating System: Windows XP (32- or 64 Bit) or higher
- Download: Browser Firefox or IE recommended
- RAM: 512 MB (Win XP min. 32 Bit 4 GB (Windows 7 x64 or higher)
- Free hard disc space:  
Minimum 20 MB free memory
- To unpack the .ZIP file 7zip or WinZIP or similar is necessary
- Adobe PDF-Reader, MS Word

## Brief Description

All program windows are self-explanatory. In addition, there is a comprehensive help function. In every program window, further details or background information is therefore provided.

The necessary data can be entered with molar, mass-specific or volume-related parameters.

In the case of a compound substitution, the user can choose from approx. 100 different compounds, for which the necessary data for the mass transfer calculation is available. An excerpt from the substance list, including the corresponding substance class, is shown on the next page.

The list includes all current organic and inorganic substance classes. Typically, every substance class contains at least 2 compounds – a substance with a lower molecular weight and one with a significantly higher molecular weight

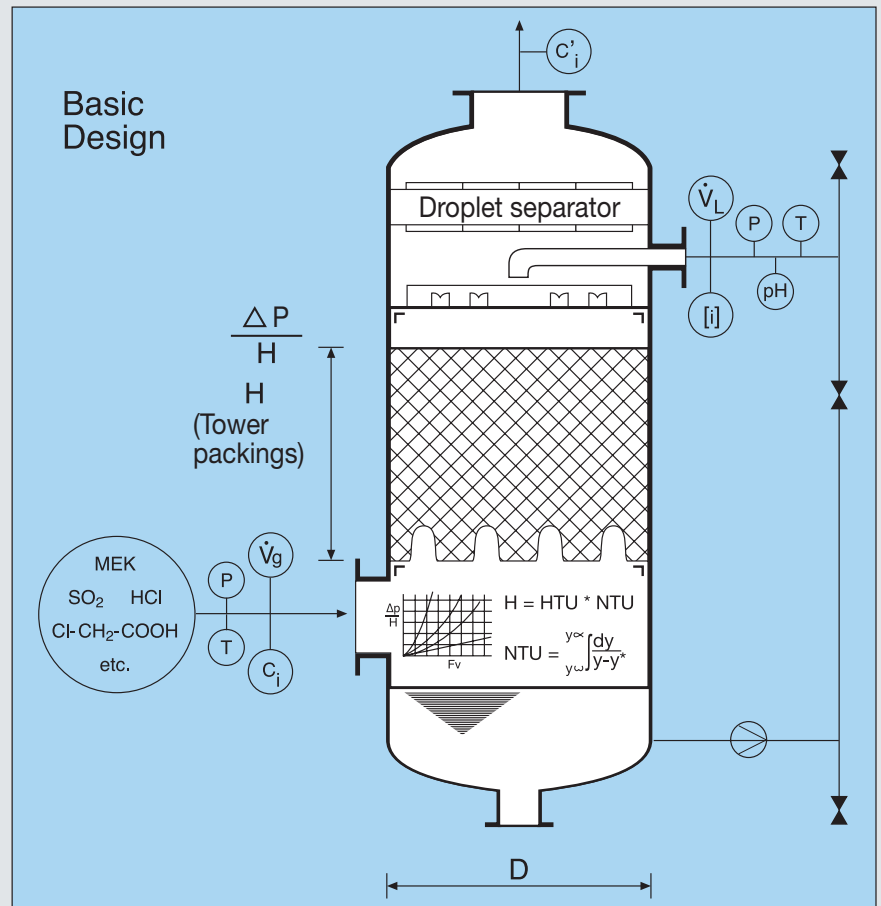

Through this, the user is typically able to estimate the feasibility of the absorption or desorption in the simplest possible way. Should the compound not be included in the list, a time-consuming data search is not necessary. One would choose, in this case, the corresponding substance class and would perform the calculation one time with a compound with a lower molecular weight and one time with a compound with a higher molecular weight.

## „VFF Random Packing Software“

The VFF Random Packing Software can be downloaded at [www.vff.com](http://www.vff.com) as trial version or complete version







### Excerpt from the substance list, sorted by substance classes:

Substance class	Substance name (the software contains several synonyms)	Formula	Empirical formula
Aldehydes (aliphatic, aromatic)	Formaldehyde	H-CHO	CH <sub>2</sub> O
	Methyl aldehyde	CH <sub>3</sub> -CHO	C <sub>2</sub> H <sub>4</sub> O
	n-Propyl aldehyde	C <sub>5</sub> H <sub>11</sub> -CHO	C <sub>6</sub> H <sub>12</sub> O
	Benzaldehyde	C <sub>6</sub> H <sub>5</sub> -CHO	C <sub>7</sub> H <sub>6</sub> O
	4-Hydroxybenzaldehyde	HO-C <sub>6</sub> H <sub>4</sub> -CHO	C <sub>7</sub> H <sub>6</sub> O <sub>2</sub>
Alcohols	Methyl alcohol	CH <sub>3</sub> -OH	CH <sub>4</sub> O
	Ethyl alcohol	C <sub>2</sub> H <sub>5</sub> -OH	C <sub>2</sub> H <sub>6</sub> O
	i-Propyl alcohol	C <sub>3</sub> H <sub>7</sub> -OH	C <sub>3</sub> H <sub>8</sub> O
	n-Octyl alcohol	C <sub>8</sub> H <sub>17</sub> -OH	C <sub>8</sub> H <sub>18</sub> O
Amines	Amino methane	CH <sub>3</sub> -NH <sub>2</sub>	CH <sub>5</sub> N
	Amino ethane	C <sub>2</sub> H <sub>5</sub> -NH <sub>2</sub>	C <sub>2</sub> H <sub>7</sub> N
	1-Amino hexane	C <sub>6</sub> H <sub>13</sub> -NH <sub>2</sub>	C <sub>6</sub> H <sub>15</sub> N
	Triethylamine	N(C <sub>2</sub> H <sub>5</sub> ) <sub>3</sub>	C <sub>6</sub> H <sub>15</sub> N
	Pyrrolidine	C <sub>4</sub> H <sub>8</sub> N-H	C <sub>4</sub> H <sub>9</sub> N
	N-Methyl-Pyrrolidine	C <sub>4</sub> H <sub>8</sub> N-CH <sub>3</sub>	C <sub>5</sub> H <sub>11</sub> N
	Piperidine	C <sub>5</sub> H <sub>11</sub> N	C <sub>5</sub> H <sub>11</sub> N
Aromatic compounds, BTX	Benzene	C <sub>6</sub> H <sub>6</sub>	C <sub>6</sub> H <sub>6</sub>
	Pyridine	C <sub>5</sub> H <sub>5</sub> N	C <sub>5</sub> H <sub>5</sub> N
	Tolnene	C <sub>6</sub> H <sub>5</sub> -CH <sub>3</sub>	C <sub>7</sub> H <sub>8</sub>
	o-Xylene	C <sub>6</sub> H <sub>4</sub> (CH <sub>3</sub> ) <sub>2</sub>	C <sub>8</sub> H <sub>10</sub>
	4-Hydroxytolnene	HO-C <sub>6</sub> H <sub>4</sub> -CH <sub>3</sub>	C <sub>7</sub> H <sub>8</sub> O
Alkanes	Methane	CH <sub>4</sub>	CH <sub>4</sub>
Epoxides	1,2-Epoxy propane	C <sub>3</sub> H <sub>6</sub> O	C <sub>3</sub> H <sub>6</sub> O
Esters	Acetic acid-Ethyl ester	CH <sub>3</sub> -COO-C <sub>2</sub> H <sub>5</sub>	C <sub>4</sub> H <sub>8</sub> O <sub>2</sub>
	n-Butylacetate	CH <sub>3</sub> -COO-C <sub>4</sub> H <sub>9</sub>	C <sub>6</sub> H <sub>12</sub> O <sub>2</sub>
Ethers	Diethyl ether	C <sub>2</sub> H <sub>5</sub> -O-C <sub>2</sub> H <sub>5</sub>	C <sub>4</sub> H <sub>10</sub> O
	Dioxane	(C <sub>2</sub> H <sub>4</sub> O) <sub>2</sub>	C <sub>4</sub> H <sub>8</sub> O <sub>2</sub>
Glycols	1,2-Dihydroxy ethane	HO-C <sub>2</sub> H <sub>4</sub> -OH	C <sub>2</sub> H <sub>6</sub> O <sub>2</sub>
Halogenated hydrocarbons (aliphatic, aromatic; LHKW or similar)	Methyl chloride	CH <sub>3</sub> -Cl	CH <sub>3</sub> Cl
	Dichloromethane	CH <sub>2</sub> Cl <sub>2</sub>	CH <sub>2</sub> Cl <sub>2</sub>
	Trichloromethane	CHCl <sub>3</sub>	CHCl <sub>3</sub>
	Carbon Tetrachloride	CCl <sub>4</sub>	CCl <sub>4</sub>
	Tribromomethane	CHBr <sub>3</sub>	CHBr <sub>3</sub>

...and lots more substance classes and compounds



## CONTACT IN GERMANY

▶ **DURANIT® Inert Balls**

Tel. +49 (0) 2623-895-10

Fax +49 (0) 2623-895-39

E-Mail: Duranit@vff.com

▶ **Random Packings made of Metal and Plastic**

Tel. +49 (0) 2623-895-23

Fax +49 (0) 2623-895-39

E-Mail: Metall@vff.com

E-Mail: Kunststoff@vff.com

▶ **Shipping Inland / Overseas**

Tel. +49 (0) 2623-895-15

Fax +49 (0) 2623-895-39

E-Mail: Export@vff.com

▶ **Software**

Tel. +49 (0) 2623-895-41

Fax +49 (0) 2623-895-39

E-Mail: Software@vff.com

▶ **Random Packings made of Ceramic**

Tel. +49 (0) 2623-895-10

Fax +49 (0) 2623-895-39

E-Mail: Keramik@vff.com

▶ **Column Internals and Droplet Separators**

Tel. +49 (0) 2623-895-43

Fax +49 (0) 2623-895-39

E-Mail: Demister@vff.com

E-Mail: Einbauten@vff.com

▶ **Application Engineering**

Tel. +49 (0) 2623-895-20 / -37

Fax +49 (0) 2623-895-39

E-Mail: Technik@vff.com

## WORLDWIDE AGENCIES



All data provided in this brochure are for general information only. Claims under the public law or any other claims cannot be derived from this information. This brochure is protected by copyright. All rights are reserved by Vereinigte Füllkörper-Fabriken GmbH & Co. KG. Any reproduction is prohibited, entirely as well as in extracts. Exploitation of any kind without prior approval by Vereinigte Füllkörper-Fabriken GmbH & Co. KG is illegal and actionable, particularly with regard to reproduction, translation, microfilming, storage and data processing inside of electronic systems.

# HOW TO REACH US

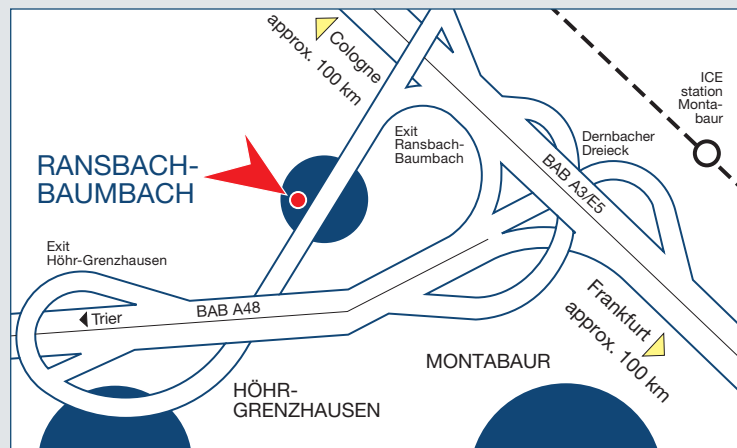

**Your expert for:**

- **DURANIT**<sup>®</sup> inert balls
- tower packings
- column internals
- droplet separators
- software for the basic column design

Welcome to our website:

**[www.vff.com](http://www.vff.com)**



**VEREINIGTE  
FÜLLKÖRPER-FABRIKEN**  
GMBH & CO. KG

**VEREINIGTE FÜLLKÖRPER-FABRIKEN GMBH & CO. KG**

P. O. Box 552, D-56225 Ransbach-Baumbach,

Phone +49 2623/895-0, Fax +49 2623/895-39, E-Mail: [info@vff.com](mailto:info@vff.com), **[www.vff.com](http://www.vff.com)**

