



SAFEMASTER PRO

The configurable safety system
– versatile and extendable

CONTENT

Introduction.....	9
Important safety instructions	9
Abbreviations and symbols.....	10
Applicable standards	10
General Description.....	11
Control unit and I/O expansion modules	12
Speed monitoring modules UG 6917	12
Fieldbus modules	13
BusExtender module UG 6918.....	13
Product composition	14
Installation	14
Mechanical fastening.....	14
Elektrical connections.....	15
USB input	15
SAFEMASTER PRO Memory chip OA 6911.....	15
MULTIPLE LOAD function	16
RESTORE Function	16
Connection terminals.....	17
Notes on the connection cables	17
Connection Terminals Control unit UG 6911.10	18
Connection Terminals Control unit UG 6911.12/080	18
Connection Terminals Input / output module UG 6916.10.....	19
Connection Terminals Input / output module UG 6916.12/080.....	19
Connection Terminals input module UG 6913.16 with 16 inputs	20
Connection Terminals input module UG 6913.12, with 12 inputs	20
Connection Terminals input module UG 6913.08, with 8 inputs	21
Connection Terminals Output module OSSD UG 6912.04, with 4 OSSD	21
Connection Terminals Output module OSSD UG 6912.02, with 2 OSSD	22
Connection Terminals Output module OSSD UG 6912.04/100, with 4 high current outputs.....	22
Connection Terminals Output module Relais UG 6912.28	23
Connection Terminals Output module Relais UG 6912.14	23
Connection Terminals Output module Relais UG 6914.04/000	23
Connection Terminals Output module Relais UG 6914.04/008	24
Connection Terminals Output module Signal UG 6915/008	24
Connection Terminals Output module Signal UG 6915/016	25
Connection Terminals Speed monitoring module UG 6917.....	25
Encoder connections (RJ45) Speed monitoring module UG 6917.....	26
Connection Terminals BusExtender module UG 6918	27
Example of connection to the machine control system	27
Calculation of safety distance of an ESPE connected to SAFEMASTER PRO.....	28
Checklist AFTER Installation	28
Project development diagram	29
Description of the signals	30
INPUTS	30
MASTER ENABLE	30
NODE SEL	30
Proximity input for speed controller	30

RESTART_FBK	31
Outputs	32
OUT STATUS.....	32
OUT TEST	32
OSSD (Control unit UG 6911.10, input / output module UG 6916.10, output modules UG 6912.02, UG 6912.04).....	33
OSSD (Control unit UG 6911.12/080, input / output module UG 6916.12/080)	34
OSSD OUTPUT CONFIGURATION.....	36
OSSD (Output module UG 6912.04/100)	37
Safety Relays (Module UG 6912.14, UG 6912.28, UG 6914.04/000, UG 6914.04/008).....	38
Characteristics of the output circuit	38
Output modules UG 6912.14 / UG 6912.28 internal contacts	38
Modul connection UG 6912.14 with UG 6911.10 ²⁾	39
Switching operation timing diagram.....	39
Technical Features	40
General System Characteristics	40
Safety level Parameters.....	40
General Data	40
General Data	41
Enclosure.....	42
Mechanical dimensions	42
Control unit UG 6911.10.....	43
Control unit UG 6911.12/080.....	43
Input / Output module UG 6916.10.....	44
Input / Output module UG 6916.12/080.....	44
Input module UG 6913.08 and UG 6913.16	45
Input module UG 6913.12	45
Output module OSSD UG 6912.02 and UG 6912.04	46
Output module OSSD UG 6912.04/100	46
Output module Relay UG 6912.14 and UG 6912.28	47
Output module Relay UG 6914.04/000 and UG 6914.04/008	48
Output module Relay UG 6914.04/000 and UG 6914.04/008	49
Output module Relay UG 6914.04/000 and UG 6914.04/008	50
Speed monitoring module UG 6917	51
Output modules signal UG 6915/008 and UG 6915/016	52
BusExtender module UG 6918.....	52
Cable for BusExtendermodul UG 6918	52
Visualisations.....	53
Control unit UG 6911.10.....	53
Control unit UG 6911.12/080.....	54
Input / Output module UG 6916.10.....	55
Input / Output module UG 6916.12/080.....	56
Input Module UG 6916.13.08, UG 6913.12 and UG 6913.16.....	57
Output module OSSD UG 6912.02 and UG 6912.04	58
Output module OSSD UG 6912.04/100	59
Output module RELAY UG 6912.14 and UG 6912.28.....	60
Output module RELAY UG 6914.04/000 and UG 6914.04/008.....	61
Output module SIGNAL UG 6915/008 and UG 6915/016	62
Speed monitoring module UG 6917/002, UG 6917/X02 and UG 6917/XX2	63

BusExtender module UG 6918.....	64
Troubleshooting	65
Control unit UG 6911.10.....	65
Control unit UG 6911.12/080.....	66
Input / Output module UG 6916.10.....	67
Input / Output module UG 6916.12/080.....	68
Input module UG 6916.13.08, UG 6913.12 and UG 6913.16.....	69
Output module OSSD UG 6912.02 and UG 6912.04.....	70
Output module OSSD UG 6912.04/100	71
Output module RELAY UG 6914.04/000 and UG 6914.04/008.....	72
Output module SIGNAL UG 6915/008	73
Output module SIGNAL UG 6915/016	74
Speed monitoring module UG 6917/002, UG 6917/X02 and UG 6917/XX2	75
BusExtender module UG 6918.....	76
Software	77
SAFEMASTER PRO DESIGNER.....	77
Installing the software.....	77
PC HARDWARE requirements.....	77
PC SOFTWARE requirements	77
How to install SAFEMASTER PRO DESIGNER	77
Fundamentals.....	78
Symbol.....	78
Opening screen	78
Standard tool bar	79
Create a new project (configure the SAFEMASTER PRO system).....	80
Edit configuration (composition of the various units).....	81
Change user Parameters.....	81
Objects - Operator - Configuration tool bars.....	81
Creating the diagram	82
Creating the diagram	83
Use of mouse right button	84
ON block input / output	84
ON Block operators	84
ON input / output terminals.....	84
ON connection (wires).....	84
Print logic diagram.....	85
Example of a project.....	86
Project validation	86
Resources Allocation (without illustration).....	87
Project report.....	88
Connect to SAFEMASTER PRO	89
Sending the configuration to the SAFEMASTER PRO	89
Download a configuration from a SAFEMASTER PRO.....	89
Configuration LOG.....	90
System composition	91
Disconnecting System.....	91
Error codes from SAFEMASTER PRO Designer	92
Error codes from SAFEMASTER PRO Designer	93
Error log download	93
MONITOR (I/O status in Textual)	94
MONITOR (I/O status in real time - textual - graphic).....	94

Password protection	95
Level 1 password.....	95
Level 2 password.....	95
Password Change	95
TESTING the system.....	96
Object functions blocks.....	97
Output objects	97
OSSD (safety outputs).....	97
SINGLE-DOUBLE OSSD (safety output)	99
Status (SIL 1 / PL c output)	102
RELAY (safety output)	103
Output Test Equipment	104
Fieldbus Probe	107
Input Objects	108
E-STOP (emergency stop)	108
E-GATE (safety gate device)	110
SINGLE E-GATE (safety gate device)	112
LOCK FEEDBACK	113
ENABLE (enable key).....	114
ESPE (optoelectronic safety light curtain / laser scanner).....	116
FOOTSWITCH (safety pedal).....	117
MOD-SEL (safety selector).....	119
PHOTOCELL (safety photocell).....	120
TWO-HAND (bimanual control)	121
SENSOR	122
S-MAT (safety mat)	123
SWITCH (Schalter).....	124
ENABLING GRIP SWITCH	125
TESTABLE SAFETY DEVICE	127
SOLID STATE DEVICE.....	129
FIELDBUS INPUT	130
LLO, LL1	130
NETWORK IN.....	131
Speed control type function blocks.....	132
Note concerning Speed Control Functional Blocks	132
SPEED CONTROL.....	133
WINDOW SPEED CONTROL	136
STAND STILL	139
STAND STILL AND SPEED CONTROL.....	142
Text Blocks.....	146
Comments	146
Title.....	146
Operator function blocks.....	147
Logical operators	147
AND	147
NAND	147
NOT	148
OR	148
NOR.....	148
XOR.....	149
XNOR	149

LOGICAL MACRO.....	150
MULTIPLEXER.....	150
DIGITAL COMPARATOR (only at UG 6911.12/080).....	151
DIGITAL COMPARATOR (only at UG 6911.12/080).....	152
Memory operators.....	153
D FLIP-FLOP (Max. 16 with UG 6911.10, 32 with UG 6911.12/080).....	153
SR FLIP-FLOP.....	154
T FLIP-FLOP.....	154
USER RESTART MANUAL (Max. 16 with UG 6911.10, 32 with UG 6911.12/080 with other RESTART operators).....	155
USER RESTART MONITORED (Max. 16 with UG 6911.10, 32 with UG 6911.12/080 with other RESTART operators).....	156
MACRO RESTART MANUAL (Max. 16 with UG 6911.10, 32 with UG 6911.12/080 with other RESTART operators).....	157
MACRO RESTART MONITORED (Max. 16 with UG 6911.10, 32 with UG 6911.12/080 with other RESTART operators).....	158
PRE-RESET (Max. 32 with UG 6911.12/080 with other RESTART operators.....	159
Guard Lock Operators.....	160
GUARD LOCK (Max. 4 with UG 6911.10, 8 with UG 6911.12/080).....	160
Description of „GUARD LOCK“ operator inputs / outputs.....	161
Operation: General description.....	163
Counter Operators.....	172
COUNTER (Max. number 16).....	172
COUNTER (Max. number 16).....	173
COUNTER COMPARATOR.....	173
Timer Operators (Max. 32 with UG 6911.10; 48 with UG 6911.12/080).....	174
CLOCKING.....	174
MONOSTABLE.....	175
MONOSTABLE B.....	176
PASSING MAKE CONTACT.....	177
DELAY.....	178
DELAY LINE.....	179
LONG DELAY.....	180
DELAY COMPARATOR.....	181
LONG DELAY LINE.....	182
Muting Operators (max. 4 with UG 6911.10, and 8 with UG 6911.12/080).....	183
The MUTING function.....	183
„Concurrent“ MUTING (MUTING "Con").....	183
„L“ MUTING.....	185
„Sequential“ MUTING.....	186
„T“ MUTING.....	188
MUTING OVERRIDE.....	189
Miscellany (special function blocks).....	191
Serial Output (MAX. 4 with UG 6911.10, 8 with UG 6911.12/080).....	191
Network.....	193
Reset.....	199
OSSD EDM (MAX. 32 with UG 6911.12/080).....	199
Interpage IN / OUT.....	201
Terminator.....	201

Special applications.....	202
Output delay with manual reset.....	202
Simulator	203
Output delay with manual	203
Schematic Simulation	204
Graphic Simulation	206
Description of the menu items	207
Description of the menu items	208
Description of the menu items	209
Accessories and spare parts	210
Liability.....	211
Declaration of Conformity	212
Declaration of Conformity	213
Notice	214
Notice	215

INTRODUCTION

This handbook describes how to use the SAFEMASTER PRO programmable safety integrated controller and its expansion units; It includes:

- A description of the system
- Method of installation
- Connections
- Signals
- Troubleshooting
- Use of the configuration software

IMPORTANT SAFETY INSTRUCTIONS



This safety alert symbol indicates a potential **personal safety hazard**. Failure to comply with instructions bearing this symbol could pose a very serious risk to personnel.



This symbol indicates an important instruction.



SAFEMASTER PRO is built to the following safety levels: SIL 3, SILCL 3, PL e, Cat. 4, Type 4 in accordance with the applicable standards. However, the definitive SIL and PL of the application will depend on the number of safety components, their Parameterss and the connections that are made, as per the risk analysis.



Read the "Applicable Standards" section carefully.



Perform an in-depth risk analysis to determine the appropriate safety level for your specific application, on the basis of all the applicable standards.



Programming/configuration of the SAFEMASTER PRO system is the sole responsibility of the installer or user.



The device must be programmed/configured in accordance with the application-specific risk analysis and all the applicable standards.



Always test the complete system whenever new safety components are added
(see the "TESTING the system" section).



Reference should be made to the handbooks and the relative product and/or application standards to ensure correct use of devices connected to the SAFEMASTER PRO system within the specific application.



The ambient temperature in the place where the system is installed must be compatible with the operating temperature Parameterss stated on the product label and in the specifications.



For all matters concerning safety, if necessary, contact your country's competent safety authorities or the competent trade association.

ABBREVIATIONS AND SYMBOLS

LL0, LL1	=	Logic level 0, logic level 1
OSSD	=	Output Signal Switching Device: Solid state safety output
MTTF _d	=	Mean Time to dangerous Failure
PL	=	Performance Level
PFH _d	=	Probability of a dangerous Failure per Hour
SIL	=	Safety Integrity Level
SILCL	=	Safety Integrity Level Claim Limit
SW	=	Software
FW	=	Firmware

APPLICABLE STANDARDS

SAFEMASTER PRO complies with the following European Directives:

- 2006/42/EC „Machinery Directive“
- 2014/30/EU „Electromagnetic Compatibility Directive“
- 2011/65/EU „RoHS Directive“

and is built to the following standards

EN 61131-2	Programmable controllers – Part 2: Equipment requirements and tests
EN ISO 13849-1	Safety of machinery – Safety related parts of control systems – Part 1: General principles for design
EN 61496-1	Safety of machinery – Electro-sensitive pREDeictive equipment – Part 1: General requirements and tests
EN 61508-1	Functional safety of electrical/electronic/programmable electronic safety-related systems – Part 1: General requirements
EN 61508-2	Functional safety of electrical/electronic/programmable electronic safety-related systems – Part 2: Requirements for electrical/electronic/programmable electronic safety-related systems
EN 61508-3	Functional safety of electrical/electronic/programmable electronic safety-related systems – Part 3: Software requirements
EN 61508-4	Functional safety of electrical/electronic/programmable electronic safety-related systems – Part 4: Definitions and abbreviations
EN 61784-3	Industrial communication networks – Profiles Part 3: Functional safety fieldbuses – General rules and profile definitions
IEC 62061	Safety of machinery – Functional safety of safety-related electrical, electronic and programmable electronic control systems
EN 81-20	Safety rules for the construction and installation of lifts – Lifts for the transport of persons and goods – Part 20: Passenger and goods passenger lifts
EN 81-50	Safety rules for the construction and installation of lifts – Examinations and tests – Part 50: Design rules, calculations, examinations and tests of lift components

GENERAL DESCRIPTION

SAFEMASTER PRO is a configurable safety system. It consists of a control unit UG 6911.10 or UG 6911.12/080, which can be configured using the SAFEMASTER PRO DESIGNER graphic interface, and a number of expansion modules connected to the control unit UG 6911.10 via the proprietary IN-RAIL-BUS.

The control unit UG 6911.10 e. g. UG 6911.12/080 can also be used as a stand-alone device. and they are equipped with:

- UG 6911.10: 8 safety inputs, 2 independent programmable dual channel safety outputs (OSSD) and 2 logic signal outputs
- UG 6911.12/080: 8 safety inputs, 4 independent programmable single channel safety outputs (OSSD) and 4 logic signal outputs

 The following expansions are available: Input / Output module (UG 6916.10 and UG 6916.12/080 (for UG 6911.12/080 only)), input modules (UG 6913.08, UG 6913.12 and UG 6913.16), output modules OSSD (UG 6912.02, UG 6912.04 and UG 6912.04/100), with dual channel semiconductor outputs, output modules relays with guided contact safety relays (UG 6914.04/000, UG 6914.04/008, UG 6912.14 and UG 6912.28), output modules with programmable signal outputs (UG 6915/008, UG 6915/016) and several speed monitoring modules (UG 6917/xx2).

 The BusExtender module UG 6918 allows a decentralized system with module connection at great distance

 For diagnostic over the main fieldbus, following fieldbus modules are available: UG 6951 (CanOpen), UG 6952 (PROFIBUS), UG 6954 (PROFINET), UG 6955 (Ethernet IP), UG 6956 (EtherCAT), UG 6957 (Universal Serial Bus), UG 6958 (MODBUS TCP/IP) and UG 6959 (MODBUS RTU).

For more detailed information, consult the fieldbus manual on the SAFEMASTER PRO Designer CD-ROM.

SAFEMASTER PRO is capable of monitoring the following safety sensors and commands: Optoelectronic sensors (safety light curtains, scanners, safety photocells), mechanical switches, safety mats, emergency stops, two-hand controls, all managed by a single flexible and expandable device.

The system must consist of just one control unit UG 6911.10 (or UG 6911.12/080) and a number of electronic expansions that can range from 0 to a maximum of 14, not more than 4 of which of the same type. There is no limit to the number of relay units that can be installed.

With 14 expansions, the system can have up to:

- UG 6911.10: 128 inputs, 16 safety outputs and 32 status outputs
- UG 6911.12/080: 128 inputs, 32 safety outputs and 48 status outputs

The control unit and its expansions modules communicate via the 5-way IN-RAIL-BUS (from DOLD), physically arranged on the rear panel of each unit.

Furthermore 8 inputs and 16 outputs probe controllable (by Fieldbus) are available.

The SAFEMASTER PRO DESIGNER software is capable of creating complex logics, using logical operators and safety functions such as muting, timer, counters, etc.

All this is performed through an easy and intuitive graphic interface.

The configuration performed on the PC is sent to the control unit UG 6911.10 (or UG 6911.12/080) via USB connection; the file resides in the control unit and can also be saved on the proprietary OA 6911 memory chip (accessory). The configuration can therefore quickly be copied to another control unit UG 6911.10 (or UG 6911.12/080).

 The SAFEMASTER PRO system is certified to the maximum safety level envisaged by the applicable industrial safety standards (SIL 3, SILCL 3, PL e, Cat. 4).

 The modules UG 6912.04/100, UG 6915/008 and UG 6915/016 are available from UG 6911.10 firmware version 3.0 or higher.

CONTROL UNIT AND I/O EXPANSION MODULES

- The control unit UG 6911.10 and the I/O Expansion module UG 6916.10 have 8 safety inputs, 2 independent programmable dual channel safety outputs (OSSD), 2 status outputs and 4 test outputs to monitor the presence of short-circuits on the inputs.
- The control unit UG 6911.12/080 and the I/O Expansion module UG 6916.12/080 have 8 safety inputs, 4 independent programmable single channel safety outputs (OSSD) (also used in pairs), 4 status outputs and 4 test outputs to monitor the presence of short-circuits on the inputs..
- The input modules UG 6913.08, UG 6913.12 and UG 6913.16 have respectively 8, 12 or 16 inputs. The modules UG 6913.08 and UG 6913.16 has 4 test outputs to monitor the presence of short-circuits on the inputs. The module UG 6913.12 has 8 test outputs and can control up to 4-wire safety maps.
- The output modules UG6912.02 and UG6912.04 have 2 or 4 independent programmable dual channel safety outputs (OSSD) respectively and 2 or 4 status outputs. The output modul UG6912.04/100 has 4 high-current safety outputs with 2.0A per channel and 8 Status-outputs.
- The relays output modules UG 6912.14 and UG 6912.28 provide the system with 2 and 4 N.O. guided contact safety relay outputs, respectively, with the related external relay feedback (N.C. contact). They are not connected over the proprietary IN-RAIL-BUS but directly to the OSSD outputs from I/O modules with OSSD output.
- Each safety output relay has 1 N.C. contact and 2 N.O. contacts.
- The relays output modules UG6914.04/000 and UG6914.04/008 are safety units provided with 4 independent safety relay outputs and the corresponding 4 inputs for the external feedback contacts (EDM).
- Each output relay has 1 N.O. contact
- There are two possible output settings (configured using the SAFEMASTER PRO Designer configuration software).
- Two pairs of connection contacts (2 N.O. contacts per output with 2 corresponding feedback inputs).
- Four independent single connection contacts (1 N.O. contact per output with 1 corresponding feedback input).
- The UG 6914.04/008 module has 8 additional programmable status outputs
- The output modules UG 6915/008 and UG 6915/016 are safety modules with 8 or 16 Programmable signal outputs, respectively.

SPEED MONITORING MODULES UG 6917

- The speed monitoring modules (UG 6917/xx2) can be used to control the following (up to PLe):
 - Zero speed, Max. speed, Speed range;
 - Direction of movement, REDation/translation;

Up to 4 speed thresholds can be set for each logic output (axis).

Each unit incorporates two logic outputs that can be configured using the SAFEMASTER PRO Designer configuration software and is thus capable of controlling up to two independent axes.

The modules are always equipped with terminal blocks for the connection of 2 proximity switches. Depending on the version, they can also be equipped with 1 or 2 RF45 sockets for the connection of 1 or 2 encoders with TTL, HTL or sin/cos signals.

FIELDBUS MODULES

- The fieldbus modules UG 6951, UG 6952, UG 6954, UG 6955, UG 6956, UG 6957, UG 6958 and UG 6959 permit the connection to the most commonly used industrial fieldbus systems for diagnostics and data transmission. They also offer the option of providing 8 non-safety-relevant inputs (Fieldbus Inputs) to the circuit diagram of the SAFEMASTER PRO system and providing the state of points in the circuit diagram as output information for the fieldbus. The UG 6911.10 allows 16 Fieldbus Probes to be displayed, while the UG 6911.12/080 allows 32 Fieldbus Probes to be displayed. The fieldbus modules are described in detail in a separate document on the CD "SAFEMASTER PRO Designer" supplied with the control unit UG 6911.

BUSEXTENDER MODULE UG 6918

- UG 6918 is an expansion module which allows the connection of the control unit UG 6911.10 (e. g. UG 6911.12/080) with other slave modules placed at great distances < 50 m (up to < 50 m between 2 groups). Through the use of a shielded cable (with RS485 compatible double twister pair shielded cable) two BusExtender modules UG 6918 placed at the desired distance can be linked together. Each BusExtender module UG 6918 has two independent connection channels; the connection of two BusExtender modules UG 6918 can be performed by wiring a channel of your choice. The figure beside allows you to view an example of connection. The system response time does not change with the use of BusExtender modules UG 6918.

 The system response time does not change with the use of module UG 6918.

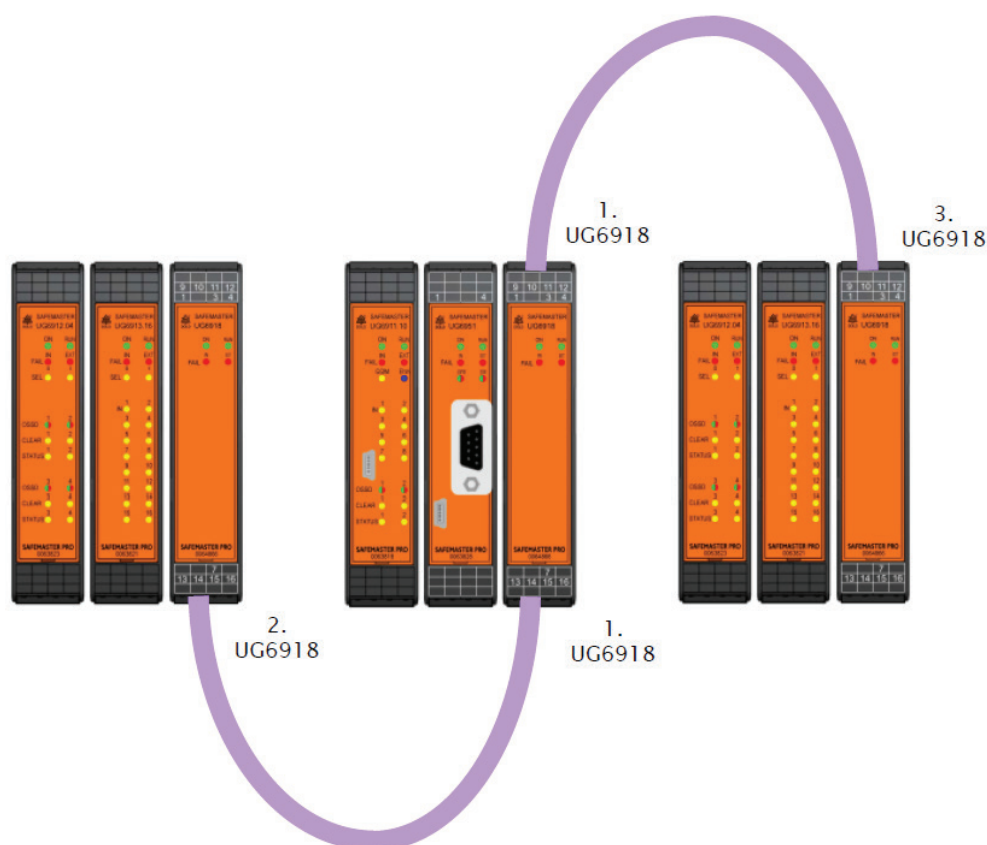

PRODUCT COMPOSITION

The control unit UG 6911.10 (or UG 6911.12/080) is supplied with:

- CD-ROM containing the free SAFEMASTER PRO DESIGNER Software, this handbook in three languages as PDF file format.
- Multilingual installation sheet.



The rear panel IN-RAIL-BUS and the memory chip OA 6911 can be ordered separately as accessories.

The expansion units are supplied with:

- Multilingual Installation sheet.



To install an expansion unit (except relay units) an IN-RAIL-BUS is necessary to connect them to the control unit UG 6911.10 (or UG 6911.12/080). This bus (length 250 mm) can be ordered as accessory.

INSTALLATION

MECHANICAL FASTENING

Fix the SAFEMASTER PRO system units to a 35 mm DIN rail as follows:

1. Fix the IN-RAIL-BUS to the DIN 35 mm (EN 5022) rail.
2. Fasten the units to the rail, arranging the contacts on the base of the IN-RAIL-BUS. Press the unit gently until you feel it snap into place.
3. To remove a unit, use a screwdriver to pull down the locking latch on the back of the unit; then lift the unit upwards and pull.



ELEKTRICAL CONNECTIONS

USB input

The SAFEMASTER PRO control unit (or UG 6911.12/080) includes a USB 2.0 connector for connection to a Personal Computer where the SAFEMASTER PRO DESIGNER configuration software resides. A USB cable is available as an accessory (OA 6920).



USB 2.0 front panel connector

SAFEMASTER PRO Memory chip OA 6911



Memory card
OA 6911



A memory chip OA6911 (optional) can be installed in the SAFEMASTER PRO control unit UG 6911.10 (or UG 6911.12/080) and used to save the software configuration Parameters.

The memory chip OA 6911 is written each time a new project is sent from the PC to the control unit.

Insert the card in the slot in the rear panel of the control unit UG 6911.10 (or UG 6911.12/080) as shown in the figure left

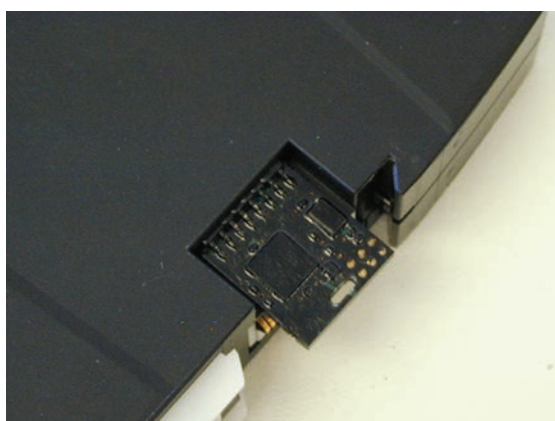

OA 6911



Always switch the control unit UG6911.10 off before insert or remove the memory chip OA 6911.

MULTIPLE LOAD function

To perform the configuration of several control units UG 6911.10 (or UG 6911.12/080) without using a PC and the USB connector, you can save the desired configuration on a single memory chip OA 6911 and then use it to download data on the control unit UG 6911.10 (or UG 6911.12/080) to be configured.



If the file contained in the memory chip OA6911 is not identical to the one contained in control unit UG 6911.10 (or UG 6911.12/080), an overwrite operation that will permanently delete the configuration data contained in the control unit will be performed.

WARNING: ALL DATA PREVIOUSLY CONTAINED IN THE CONTROL UNITS WILL BE LOST.

RESTORE Function

If the control unit UG 6911.10 (or UG 6911.12/080) is damaged, you can replace it with a new one; having already saved all the configurations on the memory chip OA 6911, all you need to do is insert the memory chip OA 6911 in the new control unit UG 6911.10 (or UG 6911.12/080) and switch on the SAFEMASTER PRO system, that will immediately load the backup configuration. In this way, the work interruptions will be minimized.



The LOAD and RESTORE functions can be disabled via software (see "Create a new project (configure the SAFEMASTER PRO system)").



In order to be used, the expansion units must be addressed at the time of installation (see the NODE SEL section).



Each time the memory chip OA 6911 is used, carefully check that the chosen configuration is the one that was planned for that particular system. Try again a fully functional test of the system composed of SAFEMASTER PRO plus all devices connected to it (see the TESTING the system section).

CONNECTION TERMINALS

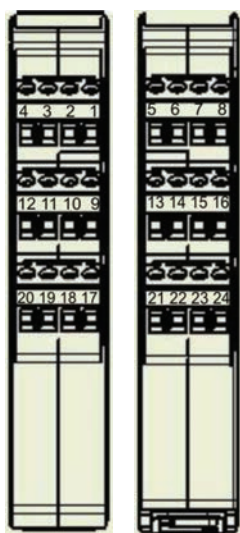



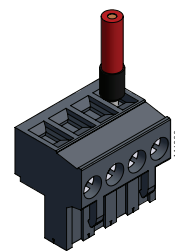

The SAFEMASTER PRO system units are provided with removable terminal blocks for the electrical connections. Each unit can have 8, 16 or 24 terminals.

Each unit also has a rear panel plug-in connector (for communication with the control unit and with the other expansion units).





The 1/2 OSSD safety relay units UG 6912.14 and UG 6912.28 are connected via terminal blocks only.



 Terminal fixing torque: 5÷7lb-in (0.6÷0.7 Nm)

-  Install safety units in an enclosure with a pREdetection class of at least IP54
-  Connect and disconnect the module only when it is not powered
-  The supply voltage to the units must be 24VDC \pm 20% (PELV, in compliance with the standard EN 60204-1 (Chapter 6.4))
-  Do not use the SAFEMASTER PRO to supply external devices
-  The same power supply connection (24VDC and 0VDC) must be used for all system components

Notes on the connection cables

-  Wire size range: AWG 12÷30 (solid / stranded) (UL).
-  Use 60 / 75°C copper (Cu) conductor only
-  Cables used for connections of longer than 50 m must have a cross-section of at least 1 mm² (AWG 16).
-  We recommend the use of separate power supplies for the safety unit and for other electrical power equipment (electric motors, inverters, frequency converters) or other sources of disturbance.

Connection Terminals Control unit UG 6911.10

TERMINAL	SIGNAL	TYPE	DESCRIPTION	OPERATION
1	24VDC	-	24 V DC power supply	-
2	MASTER_ENABLE1	Input	Master Enable 1	Input („Type 2“ acc. to EN 61131-2)
3	MASTER_ENABLE2	Input	Master Enable 2	Input („Type 2“ acc. to EN 61131-2)
4	0VDC	-	0 V DC power supply	-
5	OSSD1_A	Output	Static output 1	PNP active high
6	OSSD1_B	Output		PNP active high
7	RESTART_FBK1	Input	Feedback / Restart 1	Input („Type 2“ acc. to EN 61131-2)
8	OUT_STATUS1	Output	Programmable signal output	PNP active high
9	OSSD2_A	Output	Static output 2	PNP active high
10	OSSD2_B	Output		PNP active high
11	RESTART_FBK2	Input	Feedback / Restart 2	Input („Type 2“ acc. to EN 61131-2)
12	OUT_STATUS2	Output	Programmable signal output	PNP active high
13	OUT_TEST1	Output	Short circuit detection output	PNP active high
14	OUT_TEST2	Output	Short circuit detection output	PNP active high
15	OUT_TEST3	Output	Short circuit detection output	PNP active high
16	OUT_TEST4	Output	Short circuit detection output	PNP active high
17	INPUT1	Input	Digital input 1	Input („Type 2“ acc. to EN 61131-2)
18	INPUT2	Input	Digital input 2	Input („Type 2“ acc. to EN 61131-2)
19	INPUT3	Input	Digital input 3	Input („Type 2“ acc. to EN 61131-2)
20	INPUT4	Input	Digital input 4	Input („Type 2“ acc. to EN 61131-2)
21	INPUT5	Input	Digital input 5	Input („Type 2“ acc. to EN 61131-2)
22	INPUT6	Input	Digital input 6	Input („Type 2“ acc. to EN 61131-2)
23	INPUT7	Input	Digital input 7	Input („Type 2“ acc. to EN 61131-2)
24	INPUT8	Input	Digital input 8	Input („Type 2“ acc. to EN 61131-2)

Connection Terminals Control unit UG 6911.12/080

TERMINAL	SIGNAL	TYPE	DESCRIPTION	OPERATION
1	24VDC	-	24 V DC power supply	-
2	NC	-	-	-
3	NC	-	-	-
4	0VDC	-	0 V DC power supply	-
5	OSSD1	Output	Static output 1	PNP active high
6	OSSD2	Output	Static output 2	PNP active high
7	RESTART_FBK1/ STATUS1	Input/ Output	Feedback / Restart 1	Input („Type 2“ acc. to EN 61131-2)
			Programmable signal output	PNP active high
8	RESTART_FBK2/ STATUS2	Input/ Output	Feedback / Restart 2	Input („Type 2“ acc. to EN 61131-2)
			Programmable signal output	PNP active high
9	OSSD3	Output	Static output 3	PNP active high
10	OSSD4	Output	Static output 4	PNP active high
11	RESTART_FBK3/ STATUS3	Input/ Output	Feedback / Restart 3	Input („Type 2“ acc. to EN 61131-2)
			Programmable signal output	PNP active high
12	RESTART_FBK4/ STATUS4	Input/ Output	Feedback / Restart 4	Input („Type 2“ acc. to EN 61131-2)
			Programmable signal output	PNP active high
13	OUT_TEST1	Output	Short circuit detection output	PNP active high
14	OUT_TEST2	Output	Short circuit detection output	PNP active high
15	OUT_TEST3	Output	Short circuit detection output	PNP active high
16	OUT_TEST4	Output	Short circuit detection output	PNP active high
17	INPUT1	Input	Digital input 1	Input („Type 2“ acc. to EN 61131-2)
18	INPUT2	Input	Digital input 2	Input („Type 2“ acc. to EN 61131-2)
19	INPUT3	Input	Digital input 3	Input („Type 2“ acc. to EN 61131-2)
20	INPUT4	Input	Digital input 4	Input („Type 2“ acc. to EN 61131-2)
21	INPUT5	Input	Digital input 5	Input („Type 2“ acc. to EN 61131-2)
22	INPUT6	Input	Digital input 6	Input („Type 2“ acc. to EN 61131-2)
23	INPUT7	Input	Digital input 7	Input („Type 2“ acc. to EN 61131-2)
24	INPUT8	Input	Digital input 8	Input („Type 2“ acc. to EN 61131-2)

Connection Terminals Input / output module UG 6916.10

TERMINAL	SIGNAL	TYPE	DESCRIPTION	OPERATION
1	24VDC	-	24 V DC power supply	-
2	NODE_SEL0	Input	Node selection	Input („Type 2“ acc. to EN 61131-2)
3	NODE_SEL1	Input		Input („Type 2“ acc. to EN 61131-2)
4	0VDC	-	0 V DC power supply	-
5	OSSD1_A	Output	Static output 1	PNP active high
6	OSSD1_B	Output		PNP active high
7	RESTART_FBK1	Input	Feedback / Restart 1	Input („Type 2“ acc. to EN 61131-2)
8	OUT_STATUS1	Output	Programmable signal output	PNP active high
9	OSSD2_A	Output	Static output 2	PNP active high
10	OSSD2_B	Output		PNP active high
11	RESTART_FBK2	Input	Feedback / Restart 2	Input („Type 2“ acc. to EN 61131-2)
12	OUT_STATUS2	Output	Programmable signal output	PNP active high
13	OUT_TEST1	Output	Short circuit detection output	PNP active high
14	OUT_TEST2	Output	Short circuit detection output	PNP active high
15	OUT_TEST3	Output	Short circuit detection output	PNP active high
16	OUT_TEST4	Output	Short circuit detection output	PNP active high
17	INPUT1	Input	Digital input 1	Input („Type 2“ acc. to EN 61131-2)
18	INPUT2	Input	Digital input 2	Input („Type 2“ acc. to EN 61131-2)
19	INPUT3	Input	Digital input 3	Input („Type 2“ acc. to EN 61131-2)
20	INPUT4	Input	Digital input 4	Input („Type 2“ acc. to EN 61131-2)
21	INPUT5	Input	Digital input 5	Input („Type 2“ acc. to EN 61131-2)
22	INPUT6	Input	Digital input 6	Input („Type 2“ acc. to EN 61131-2)
23	INPUT7	Input	Digital input 7	Input („Type 2“ acc. to EN 61131-2)
24	INPUT8	Input	Digital input 8	Input („Type 2“ acc. to EN 61131-2)

Connection Terminals Input / output module UG 6916.12/080

TERMINAL	SIGNAL	TYPE	DESCRIPTION	OPERATION
1	24VDC	-	24 V DC power supply	-
2	NODE_SEL0	Input	Node selection	Input („Type 2“ acc. to EN 61131-2)
3	NODE_SEL1	Input		Input („Type 2“ acc. to EN 61131-2)
4	0VDC	-	0 V DC power supply	-
5	OSSD1	Output	Static output 1	PNP active high
6	OSSD2	Output	Static output 2	PNP active high
7	RESTART_FBK1/ STATUS1	Input/	Feedback / Restart 1	Input („Type 2“ acc. to EN 61131-2)
		Output	Programmable signal output	PNP active high
8	RESTART_FBK2/ STATUS2	Input/	Feedback / Restart 2	Input („Type 2“ acc. to EN 61131-2)
		Output	Programmable signal output	PNP active high
9	OSSD3	Output	Static output 3	PNP active high
10	OSSD4	Output	Static output 4	PNP active high
11	RESTART_FBK3/ STATUS3	Input/	Feedback / Restart 3	Input („Type 2“ acc. to EN 61131-2)
		Output	Programmable signal output	PNP active high
12	RESTART_FBK4/ STATUS4	Input/	Feedback / Restart 4	Input („Type 2“ acc. to EN 61131-2)
		Output	Programmable signal output	PNP active high
13	OUT_TEST1	Output	Short circuit detection output	PNP active high
14	OUT_TEST2	Output	Short circuit detection output	PNP active high
15	OUT_TEST3	Output	Short circuit detection output	PNP active high
16	OUT_TEST4	Output	Short circuit detection output	PNP active high
17	INPUT1	Input	Digital input 1	Input („Type 2“ acc. to EN 61131-2)
18	INPUT2	Input	Digital input 2	Input („Type 2“ acc. to EN 61131-2)
19	INPUT3	Input	Digital input 3	Input („Type 2“ acc. to EN 61131-2)
20	INPUT4	Input	Digital input 4	Input („Type 2“ acc. to EN 61131-2)
21	INPUT5	Input	Digital input 5	Input („Type 2“ acc. to EN 61131-2)
22	INPUT6	Input	Digital input 6	Input („Type 2“ acc. to EN 61131-2)
23	INPUT7	Input	Digital input 7	Input („Type 2“ acc. to EN 61131-2)
24	INPUT8	Input	Digital input 8	Input („Type 2“ acc. to EN 61131-2)



The STATUS signal outputs are shared with the feedback/restart inputs of the OSSDs. To use them, the corresponding OSSD must be used with automatic reset without external feedback monitoring. For example, to use the STATUS1 output (Terminal 7), you must program OSSD1 with automatic reset without K feedback monitoring.

Connection Terminals input module UG 6913.16 with 16 inputs

TERMINAL	SIGNAL	TYPE	DESCRIPTION	OPERATION
1	24VDC	-	24 V DC power supply	-
2	NODE_SEL0	Input	Node selection	Input („Type 2“ acc. to EN 61131-2)
3	NODE_SEL1	Input		Input („Type 2“ acc. to EN 61131-2)
4	0VDC	-	0 V DC power supply	-
5	INPUT1	Input	Digital input 1	Input („Type 2“ acc. to EN 61131-2)
6	INPUT2	Input	Digital input 2	Input („Type 2“ acc. to EN 61131-2)
7	INPUT3	Input	Digital input 3	Input („Type 2“ acc. to EN 61131-2)
8	INPUT4	Input	Digital input 4	Input („Type 2“ acc. to EN 61131-2)
9	OUT_TEST1	Output	Short circuit detection output	PNP active high
10	OUT_TEST2	Output	Short circuit detection output	PNP active high
11	OUT_TEST3	Output	Short circuit detection output	PNP active high
12	OUT_TEST4	Output	Short circuit detection output	PNP active high
13	INPUT5	Input	Digital input 5	Input („Type 2“ acc. to EN 61131-2)
14	INPUT6	Input	Digital input 6	Input („Type 2“ acc. to EN 61131-2)
15	INPUT7	Input	Digital input 7	Input („Type 2“ acc. to EN 61131-2)
16	INPUT8	Input	Digital input 8	Input („Type 2“ acc. to EN 61131-2)
17	INPUT9	Input	Digital input 9	Input („Type 2“ acc. to EN 61131-2)
18	INPUT10	Input	Digital input 10	Input („Type 2“ acc. to EN 61131-2)
19	INPUT11	Input	Digital input 11	Input („Type 2“ acc. to EN 61131-2)
20	INPUT12	Input	Digital input 12	Input („Type 2“ acc. to EN 61131-2)
21	INPUT13	Input	Digital input 13	Input („Type 2“ acc. to EN 61131-2)
22	INPUT14	Input	Digital input 14	Input („Type 2“ acc. to EN 61131-2)
23	INPUT15	Input	Digital input 15	Input („Type 2“ acc. to EN 61131-2)
24	INPUT16	Input	Digital input 16	Input („Type 2“ acc. to EN 61131-2)

Connection Terminals input module UG 6913.12, with 12 inputs

TERMINAL	SIGNAL	TYPE	DESCRIPTION	OPERATION
1	24VDC	-	24 V DC power supply	-
2	NODE_SEL0	Input	Node selection	Input („Type 2“ acc. to EN 61131-2)
3	NODE_SEL1	Input		Input („Type 2“ acc. to EN 61131-2)
4	0VDC	-	0V DC power supply	-
5	INPUT1	Input	Digital input 1	Input („Type 2“ acc. to EN 61131-2)
6	INPUT2	Input	Digital input 2	Input („Type 2“ acc. to EN 61131-2)
7	INPUT3	Input	Digital input 3	Input („Type 2“ acc. to EN 61131-2)
8	INPUT4	Input	Digital input 4	Input („Type 2“ acc. to EN 61131-2)
9	OUT_TEST1	Output	Short circuit detection output	PNP active high
10	OUT_TEST2	Output	Short circuit detection output	PNP active high
11	OUT_TEST3	Output	Short circuit detection output	PNP active high
12	OUT_TEST4	Output	Short circuit detection output	PNP active high
13	INPUT5	Input	Digital input 5	Input („Type 2“ acc. to EN 61131-2)
14	INPUT6	Input	Digital input 6	Input („Type 2“ acc. to EN 61131-2)
15	INPUT7	Input	Digital input 7	Input („Type 2“ acc. to EN 61131-2)
16	INPUT8	Input	Digital input 8	Input („Type 2“ acc. to EN 61131-2)
17	OUT_TEST5	Output	Short circuit detection output	PNP active high
18	OUT_TEST6	Output	Short circuit detection output	PNP active high
19	OUT_TEST7	Output	Short circuit detection output	PNP active high
20	OUT_TEST8	Output	Short circuit detection output	PNP active high
21	INPUT9	Input	Digital input 9	Input („Type 2“ acc. to EN 61131-2)
22	INPUT10	Input	Digital input 10	Input („Type 2“ acc. to EN 61131-2)
23	INPUT11	Input	Digital input 11	Input („Type 2“ acc. to EN 61131-2)
24	INPUT12	Input	Digital input 12	Input („Type 2“ acc. to EN 61131-2)

Connection Terminals input module UG 6913.08, with 8 inputs

TERMINAL	SIGNAL	TYPE	DESCRIPTION	OPERATION
1	24VDC	-	24 V DC power supply	-
2	NODE_SEL0	Input	Node selection	Input („Type 2“ acc. to EN 61131-2)
3	NODE_SEL1	Input		Input („Type 2“ acc. to EN 61131-2)
4	0VDC	-	0 V DC power supply	-
5	INPUT1	Input	Digital input 1	Input („Type 2“ acc. to EN 61131-2)
6	INPUT2	Input	Digital input 2	Input („Type 2“ acc. to EN 61131-2)
7	INPUT3	Input	Digital input 3	Input („Type 2“ acc. to EN 61131-2)
8	INPUT4	Input	Digital input 4	Input („Type 2“ acc. to EN 61131-2)
9	OUT_TEST1	Output	Short circuit detection output	PNP active high
10	OUT_TEST2	Output	Short circuit detection output	PNP active high
11	OUT_TEST3	Output	Short circuit detection output	PNP active high
12	OUT_TEST4	Output	Short circuit detection output	PNP active high
13	INPUT5	Input	Digital input 5	Input („Type 2“ acc. to EN 61131-2)
14	INPUT6	Input	Digital input 6	Input („Type 2“ acc. to EN 61131-2)
15	INPUT7	Input	Digital input 7	Input („Type 2“ acc. to EN 61131-2)
16	INPUT8	Input	Digital input 8	Input („Type 2“ acc. to EN 61131-2)

Connection Terminals Output module OSSD UG 6912.04, with 4 OSSD

TERMINAL	SIGNAL	TYPE	DESCRIPTION	OPERATION
1	24VDC	-	24 V DC power supply	-
2	NODE_SEL0	Input	Node selection	Input („Type 2“ acc. to EN 61131-2)
3	NODE_SEL1	Input		Input („Type 2“ acc. to EN 61131-2)
4	0VDC	-	0 V DC power supply	-
5	OSSD1_A	Output	Static output 1	PNP active high
6	OSSD1_B	Output		PNP active high
7	RESTART_FBK1	Input	Feedback / Restart 1	Input („Type 2“ acc. to EN 61131-2)
8	OUT_STATUS1	Output	Programmable signal output	PNP active high
9	OSSD2_A	Output	Static output 2	PNP active high
10	OSSD2_B	Output		PNP active high
11	RESTART_FBK2	Input	Feedback / Restart 2	Input („Type 2“ acc. to EN 61131-2)
12	OUT_STATUS2	Output	Programmable signal output	PNP active high
13	24VDC	-	24 V DC power supply	24 V DC power supply-Ausgänge *
14	24VDC	-	24 V DC power supply	
15	0VDC	-	0 V DC power supply	0 V DC power supply-Ausgänge *
16	0VDC	-	0 V DC power supply	
17	OSSD4_A	Output	Static output 4	PNP active high
18	OSSD4_B	Output		PNP active high
19	RESTART_FBK4	Input	Feedback / Restart 4	Input („Type 2“ acc. to EN 61131-2)
20	OUT_STATUS4	Output	Programmable signal output	PNP active high
21	OSSD3_A	Output	Static output 3	PNP active high
22	OSSD3_B	Output		PNP active high
23	RESTART_FBK3	Input	Feedback / Restart 3	Input („Type 2“ acc. to EN 61131-2)
24	OUT_STATUS3	Output	Programmable signal output	PNP active high

Connection Terminals Output module OSSD UG 6912.02, with 2 OSSD

TERMINAL	SIGNAL	TYPE	DESCRIPTION	OPERATION
1	24VDC	-	24 V DC power supply	-
2	NODE_SEL0	Input	Node selection	Input („Type 2“ acc. to EN 61131-2)
3	NODE_SEL1	Input		Input („Type 2“ acc. to EN 61131-2)
4	0VDC	-	0 V DC power supply	-
5	OSSD1_A	Output	Static output 1	PNP active high
6	OSSD1_B	Output		PNP active high
7	RESTART_FBK1	Input	Feedback / Restart 1	Input („Type 2“ acc. to EN 61131-2)
8	OUT_STATUS1	Output	Programmable signal output 1	PNP active high
9	OSSD2_A	Output	Static output 2	PNP active high
10	OSSD2_B	Output		PNP active high
11	RESTART_FBK2	Input	Feedback / Restart 2	Input („Type 2“ acc. to EN 61131-2)
12	OUT_STATUS2	Output	Programmable signal output 2	PNP active high
13	24VDC	-	24 V DC power supply	24 V DC power supply-outputs *
14	N.C.	-	-	-
15	0VDC	-	0 V DC power supply	0 V DC power supply-outputs *
16	N.C.	-	-	-

*) This terminal must be connected to the power supply for the unit to work properly

Connection Terminals Output module OSSD UG 6912.04/100, with 4 high current outputs

TERMINAL	SIGNAL	TYPE	DESCRIPTION	OPERATION
1	24VDC	-	24 V DC power supply	-
2	NODE_SEL0	Input	Node selection	Input („Type 2“ acc. to EN 61131-2)
3	NODE_SEL1	Input		Input („Type 2“ acc. to EN 61131-2)
4	0VDC	-	0 V DC power supply	-
5	RESTART_FBK1	Input	Feedback / Restart 1	Input („Type 2“ acc. to EN 61131-2)
6	RESTART_FBK2	Input	Feedback / Restart 2	Input („Type 2“ acc. to EN 61131-2)
7	RESTART_FBK3	Input	Feedback / Restart 3	Input („Type 2“ acc. to EN 61131-2)
8	RESTART_FBK4	Input	Feedback / Restart 4	Input („Type 2“ acc. to EN 61131-2)
9	OSSD1	Output	Static output 1	PNP active high 4 Einzelkanäle (oder 2 Doppelkanäle)
10	OSSD2	Output	Static output 2	
11	OSSD3	Output	Static output 3	
12	OSSD4	Output	Static output 4	
13	-	-	-	-
14	24VDC	-	24 V DC power supply	Versorgung OSSD3 / 4
15	-	-	-	-
16	-	-	-	-
17	OUT_STATUS1	Output	Programmable signal output 1	PNP active high
18	OUT_STATUS2	Output	Programmable signal output 2	PNP active high
19	OUT_STATUS3	Output	Programmable signal output 3	PNP active high
20	OUT_STATUS4	Output	Programmable signal output 4	PNP active high
21	OUT_STATUS5	Output	Programmable signal output 5	PNP active high
22	OUT_STATUS6	Output	Programmable signal output 6	PNP active high
23	OUT_STATUS7	Output	Programmable signal output 7	PNP active high
24	OUT_STATUS8	Output	Programmable signal output 8	PNP active high

Connection Terminals Output module Relais UG 6912.28

TERMINAL	SIGNAL	TYPE	DESCRIPTION	OPERATION
1	24VDC	-	channel	-
4	0VDC	-	0 V DC power supply	-
5	OSSD1_A	Input	Steuerung channel 1	PNP active high
6	OSSD1_B	Input		
7	FBK_K1_K2_1	Output	Feedback K1 K2 channel 1	N.C.
9	A_NC1	Output	NC contact channel 1	-
10	B_NC1	Output		
13	A_NO11	Output	NO1 contact channel 1	-
14	B_NO11	Output		
15	A_NO12	Output	NO2 contact channel 1	-
16	B_NO12	Output		
11	A_NC2	Output	NC contact channel 2	-
12	B_NC2	Output		
17	OSSD2_A	Input	Control channel 2	PNP active high
18	OSSD2_B	Input		
19	FBK_K1_K2_2	Output	Feedback K1 K2 channel 2	N.C.
21	A_NO21	Output	NO1 contact channel 2	-
22	B_NO21	Output		
23	A_NO22	Output	NO2 contact channel 2	-
24	B_NO22	Output		

Connection Terminals Output module Relais UG 6912.14

TERMINAL	SIGNAL	TYPE	DESCRIPTION	OPERATION
1	24VDC	-	24 V DC power supply	-
4	0VDC	-	0 V DC power supply	-
5	OSSD1_A	Input	Control channel 1	PNP active high
6	OSSD1_B	Input		
7	FBK_K1_K2_1	Output	Feedback K1 K2 channel 1	N.C.
9	A_NC1	Output	NC contact channel 1	-
10	B_NC1	Output		
13	A_NO11	Output	NO1 contact 1 channel 1	-
14	B_NO11	Output		
15	A_NO12	Output	NO1 contact 2 channel 1	-
16	B_NO12	Output		

Connection Terminals Output module Relais UG 6914.04/000

TERMINAL	SIGNAL	TYPE	DESCRIPTION	OPERATION
1	24VDC	-	24 V DC power supply	-
2	NODE_SEL0	Input	Node selection	Input („Type 2“ acc. to EN 61131-2)
3	NODE_SEL1	Input		Input („Type 2“ acc. to EN 61131-2)
4	0VDC	-	0 V DC power supply	-
5	REST_FBK1	Input	Feedback / Restart 1	Input („Type 2“ acc. to EN 61131-2)
6	REST_FBK2	Input	Feedback / Restart 2	Input („Type 2“ acc. to EN 61131-2)
7	REST_FBK3	Input	Feedback / Restart 3	Input („Type 2“ acc. to EN 61131-2)
8	REST_FBK4	Input	Feedback / Restart 4	Input („Type 2“ acc. to EN 61131-2)
9	A_NO1	Output	NO contact channel 1	
10	B_NO1	Output		
11	A_NO2	Output	NO contact channel 2	
12	B_NO2	Output		
13	A_NO3	Output	NO contact channel 3	
14	B_NO3	Output		
15	A_NO4	Output	NO contact channel 4	
16	B_NO4	Output		

Connection Terminals Output module Relais UG 6914.04/008

TERMINAL	SIGNAL	TYPE	DESCRIPTION	OPERATION
1	24VDC	-	24 V DC power supply	-
2	NODE_SEL0	Input	Node selection	Input („Type 2“ acc. to EN 61131-2)
3	NODE_SEL1	Input		Input („Type 2“ acc. to EN 61131-2)
4	0VDC	-	0 V DC power supply	-
5	REST_FBK1	Input	Feedback / Restart 1	Input („Type 2“ acc. to EN 61131-2)
6	REST_FBK2	Input	Feedback / Restart 2	Input („Type 2“ acc. to EN 61131-2)
7	REST_FBK3	Input	Feedback / Restart 3	Input („Type 2“ acc. to EN 61131-2)
8	REST_FBK4	Input	Feedback / Restart 4	Input („Type 2“ acc. to EN 61131-2)
9	A_NO1	Output	NO contact channel 1	
10	B_NO1	Output		
11	A_NO2	Output	NO contact channel 2	
12	B_NO2	Output		
13	A_NO3	Output	NO contact channel 3	
14	B_NO3	Output		
15	A_NO4	Output	NO contact channel 4	
16	B_NO4	Output		
17	OUT_STATUS1	Output	Programmable signal output 1	PNP active high
18	OUT_STATUS2	Output	Programmable signal output 2	PNP active high
19	OUT_STATUS3	Output	Programmable signal output 3	PNP active high
20	OUT_STATUS4	Output	Programmable signal output 4	PNP active high
21	OUT_STATUS5	Output	Programmable signal output 5	PNP active high
22	OUT_STATUS6	Output	Programmable signal output 6	PNP active high
23	OUT_STATUS7	Output	Programmable signal output 7	PNP active high
24	OUT_STATUS8	Output	Programmable signal output 8	PNP active high

Connection Terminals Output module Signal UG 6915/008

TERMINAL	SIGNAL	TYPE	DESCRIPTION	OPERATION
1	24VDC	-	24 V DC power supply	-
2	NODE_SEL0	Input	Node selection	Input („Type 2“ acc. to EN 61131-2)
3	NODE_SEL1	Input		Input („Type 2“ acc. to EN 61131-2)
4	0VDC	-	0 V DC power supply	-
5	24VDC STATUS 1-8	-	24 V DC power supply OUTPUT STATUS 1-8	-
6	-	-	-	-
7	-	-	-	-
8	-	-	-	-
9	OUT_STATUS1	Output	Programmable signal output 1	PNP active high
10	OUT_STATUS2	Output	Programmable signal output 2	PNP active high
11	OUT_STATUS3	Output	Programmable signal output 3	PNP active high
12	OUT_STATUS4	Output	Programmable signal output 4	PNP active high
13	OUT_STATUS5	Output	Programmable signal output 5	PNP active high
14	OUT_STATUS6	Output	Programmable signal output 6	PNP active high
15	OUT_STATUS7	Output	Programmable signal output 7	PNP active high
16	OUT_STATUS8	Output	Programmable signal output 8	PNP active high

Connection Terminals Output module Signal UG 6915/016

TERMINAL	SIGNAL	TYPE	DESCRIPTION	OPERATION
1	24VDC	-	24 V DC power supply	-
2	NODE_SEL0	Input	Node selection	Input („Type 2“ acc. to EN 61131-2)
3	NODE_SEL1	Input		Input („Type 2“ acc. to EN 61131-2)
4	0VDC	-	0 V DC power supply	-
5	24VDC STATUS 1-8	-	24 V DC power supply OUTPUT STATUS 1-8	-
6	24VDC STATUS 9-16	-	24 V DC power supply OUTPUT STATUS 9-16	-
7	-	-	-	-
8	-	-	-	-
9	OUT_STATUS1	Output	Programmable signal output 1	PNP active high
10	OUT_STATUS2	Output	Programmable signal output 2	PNP active high
11	OUT_STATUS3	Output	Programmable signal output 3	PNP active high
12	OUT_STATUS4	Output	Programmable signal output 4	PNP active high
13	OUT_STATUS5	Output	Programmable signal output 5	PNP active high
14	OUT_STATUS6	Output	Programmable signal output 6	PNP active high
15	OUT_STATUS7	Output	Programmable signal output 7	PNP active high
16	OUT_STATUS8	Output	Programmable signal output 8	PNP active high
17	OUT_STATUS9	Output	Programmable signal output 9	PNP active high
18	OUT_STATUS10	Output	Programmable signal output 10	PNP active high
19	OUT_STATUS11	Output	Programmable signal output 11	PNP active high
20	OUT_STATUS12	Output	Programmable signal output 12	PNP active high
21	OUT_STATUS13	Output	Programmable signal output 13	PNP active high
22	OUT_STATUS14	Output	Programmable signal output 14	PNP active high
23	OUT_STATUS15	Output	Programmable signal output 15	PNP active high
24	OUT_STATUS16	Output	Programmable signal output 16	PNP active high

Connection Terminals Speed monitoring module UG 6917

TERMINAL	SIGNAL	TYPE	DESCRIPTION	OPERATION
1	24VDC	-	24 V DC power supply	-
2	NODE_SEL0	Input	Node selection	Input („Type 2“ acc. to EN 61131-2)
3	NODE_SEL1	Input		Input („Type 2“ acc. to EN 61131-2)
4	0VDC	-	0 V DC power supply	-
5	PROXI1_24V	Output	PROXIMITY 1 connections	24 V DC power supply an PROXI1
6	PROXI1_REF	Output		0 V DC power supply an PROXI1
7	PROXI1 IN1 (3 WIRES)	Input		PROXI1 NO input
8	PROXI1 IN2 (4 WIRES)	Input		PROXI1 NC input
9	PROXI2_24V	Output	PROXIMITY 1 connections	24 VDC power supply to PROXI2
10	PROXI2_REF	Output		0 V DC power supply to PROXI2
11	PROXI2 IN1 (3 WIRES)	Input		PROXI2 NO input
12	PROXI2 IN2 (4 WIRES)	Input		PROXI2 NC input

Encoder connections (RJ45) Speed monitoring module UG 6917

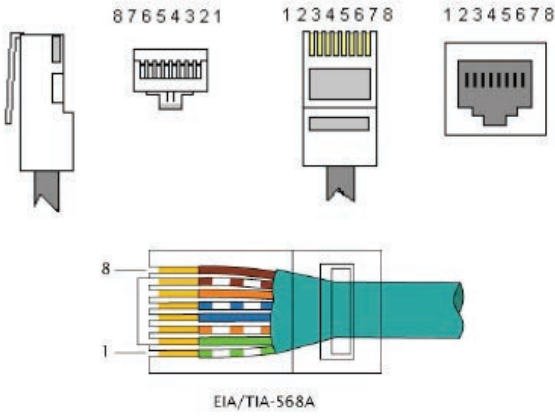

Pin		TTL UG 6917/102 UG 6917/112	HTL UG 6917/202 UG 6917/222	Sin / Cos UG 6917/302 UG 6917/332
Twisted*	1	5VDC	N.C.	N.C.
	2	EXT_OV	EXT_OV	EXT_OV
	3	N.C.	N.C.	N.C.
Twisted*	4	A	A	A
	5	/A	/A	/A
	6	N.C.	N.C.	N.C.
Twisted*	7	B	B	B
	8	/B	/B	/B

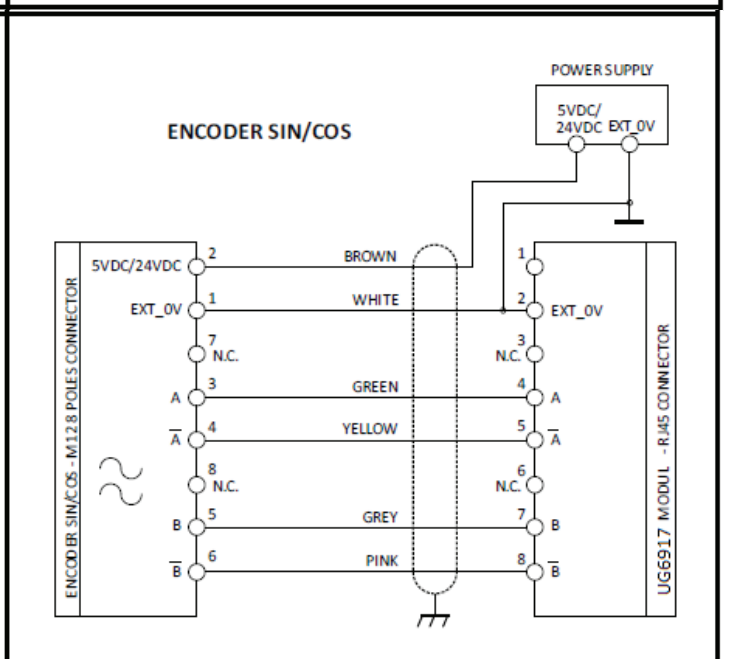
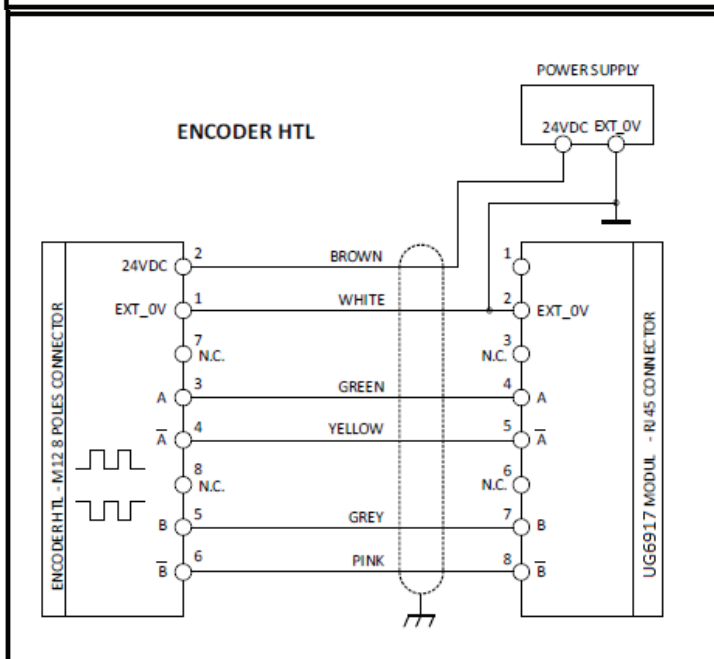
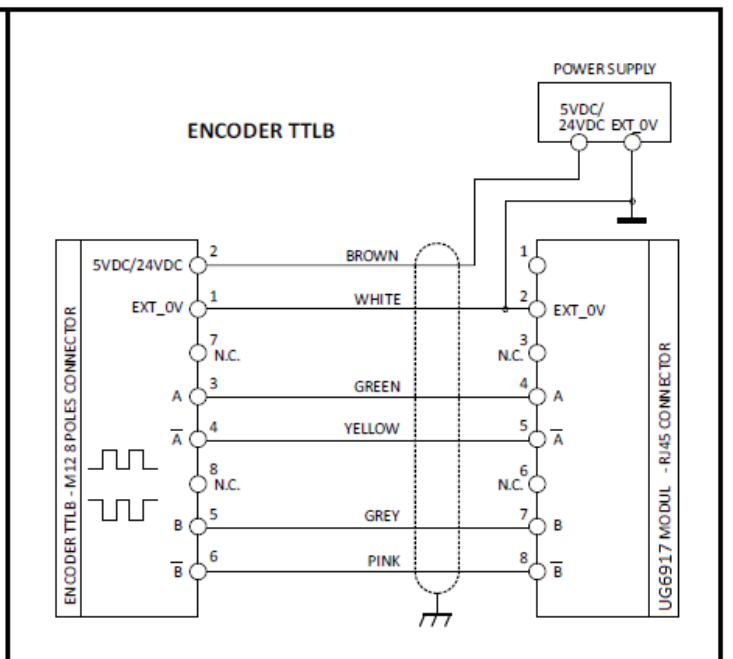
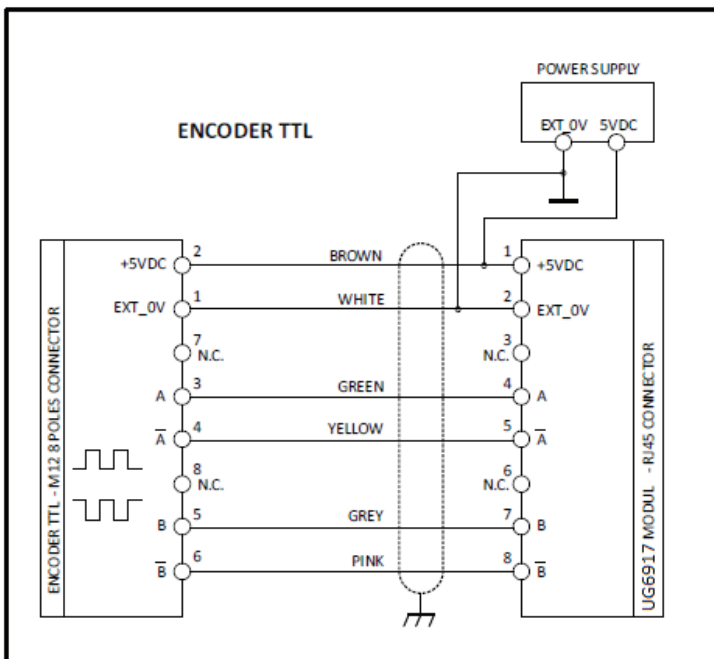

Connection Terminals BusExtender module UG 6918

TERMINAL	SIGNAL	TYPE	
1	+24 VDC	Power supply 24 VDC	
2		-	
3	Shield CH1	-	
4	0 VDC	Power supply 0 VDC	
5		-	
6		-	
7	Shield CH2	-	
8		-	
9	CH 1 - A	1 st twisted pair of conductors	Be sure to connect corresponding terminals to corresponding channels of the remote UG6918: CH 1 <-> CH 1 or CH 2 <-> CH 2 A <-> A B <-> B C <-> C D <-> D Shield <-> Shield
10	CH 1 - B		
11	CH 1 - C	2 nd twisted pair of conductors	
12	CH 1 - D		
13	CH 2 - A	1 st twisted pair of conductors	
14	CH 2 - B		
15	CH 2 - C	2 nd twisted pair of conductors	
16	CH 2 - D		

EXAMPLE OF CONNECTION TO THE MACHINE CONTROL SYSTEM

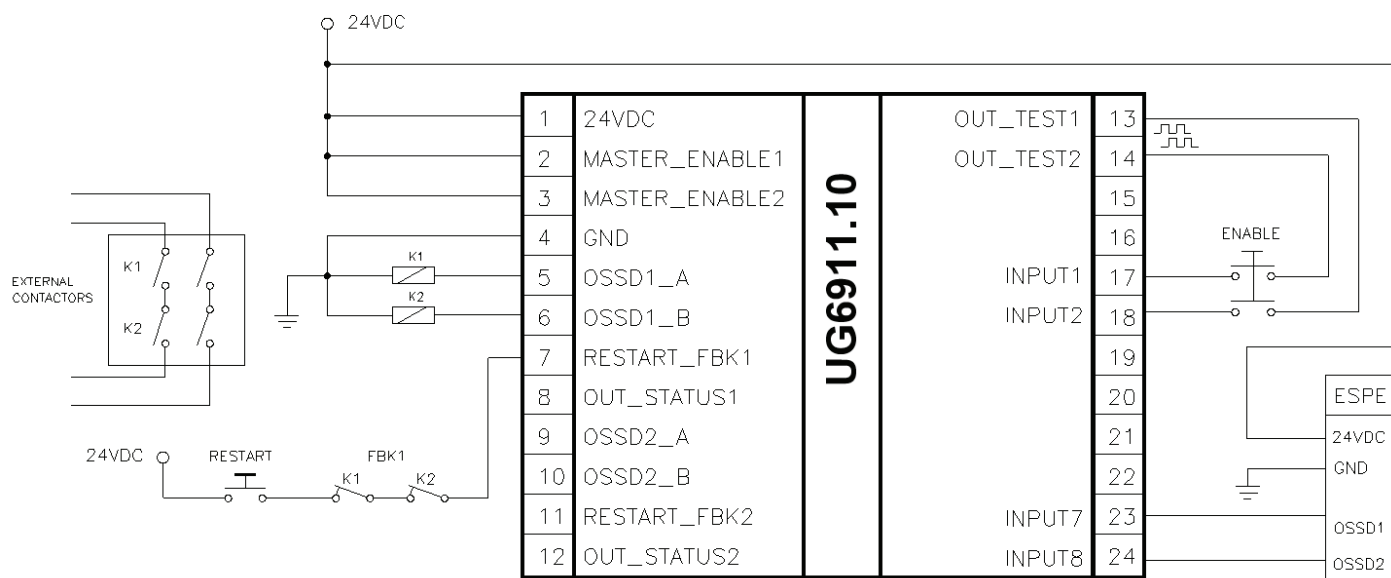

CALCULATION OF SAFETY DISTANCE OF AN ESPE CONNECTED TO SAFEMASTER PRO

Any Electro-sensitive PREDetective Equipment device (ESPE) connected to SAFEMASTER PRO, must be positioned at a distance equal to or greater than the minimum safety distance S so that the dangerous point can be reached only after stopping the dangerous movement of the machine.



The European standard:

- ISO 13855:2010- (EN 999:2008) *Safety of machinery. Positioning of safeguards with respect to the approach speeds of parts of the human body* ¹⁾ provides the elements to calculate the proper safety distance.



Carefully read the installation manual of each device for specific information on the correct positioning.



Remember that the total response time depends on:

SAFEMASTER PRO response time + ESPE response time + response time of the machine (i.e. the time taken by the machine to stop the dangerous movement from the moment in which the stop signal is transmitted).

CHECKLIST AFTER INSTALLATION

The SAFEMASTER PRO system is able to detect the faults that occurs in each own unit.

Anyway to have the system perfect operation, perform the following checks at start up and at least every one year:

1. Operate a complete system TEST (see "TESTING the system")
2. Verify that all the cables are correctly inserted and the terminal blocks well screwed.
3. Verify that all the LEDs (indicators) light on correctly.
4. Verify the positioning of all the sensors connected to SAFEMASTER PRO.
5. Verify the correct fixing of SAFEMASTER PRO to the 35mm rail.
6. Verify that all the external indicators (lamps) work properly.



After installation, maintenance and after any eventual configuration change perform a System TEST as described in the paragraph "TESTING the system"

¹⁾ "Describe the methods that designers can use to calculate the minimum safety distance from a specific dangerous point for the safety devices, particularly Electro-sensitive devices (eg. light curtains), safety-mats or pressure sensitive floors and bimanual control. It contains a rule to determine the placement of safety devices based on approach speed and the stopping time of the machine, which can reasonably be extrapolated so that it also includes the interlocking guards without guard locking."

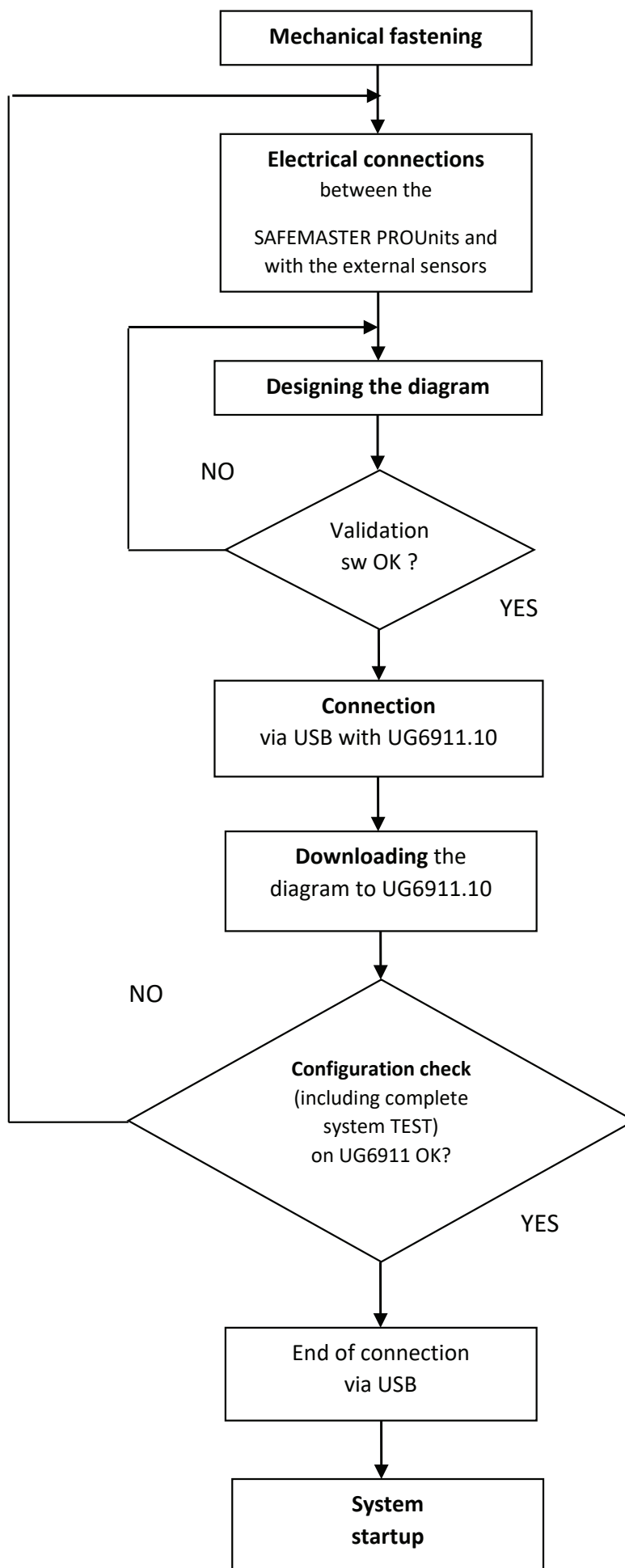

PROJECT DEVELOPMENT DIAGRAM

DESCRIPTION OF THE SIGNALS

INPUTS

MASTER ENABLE

The control unit UG 6911.10 control unit has two inputs: MASTER_ENABLE1 and MASTER_ENABLE2:



-  These signals must both be permanently set to logic level 1 (24 V DC) for the SAFEMASTER PRO to operate. If the user needs to disable the SAFEMASTER PRO simply lower these inputs to logic level 0 (0VDC).
-  These inputs are not present on the UG 6911.12/080 units as they are always enabled.

NODE SEL

The NODE_SEL0 and NODE_SEL1 inputs (on the expansion units) are used to attribute a physical address to the expansion units with the connections shown in Table :





	NODE_SEL0	NODE_SEL1
NODE 0	0 (oder not connected)	0 (oder not connected)
NODE 1	24 V DC	0 (oder not connected)
NODE 2	0 (oder not connected)	24 V DC
NODE 3	24 V DC	24 V DC

A max. of 4 adresses and thus a max. of 4 modules of the same type can be used in one system

-  It is not allowed to use the same address on two units of the same type.
-  In order to be used, the expansion units must be addressed at installation time.

Proximity input for speed controller

Configuration with Interleaved Proximity

-  Improper mechanical installation of proximity sensors can lead to dangerous operation. Pay particular attention to the size of the coding disks.
-  The UG 6917 module must be capable of detecting the expected speed in any state. Perform a complete system test during installation and periodically during operation.
-  Using the SAFEMASTER Pro-Software and the sensor LEDs, ensure that the module never detects anomalies.
-  The coding disk must be dimensioned and the proximity sensors positioned according to the technical data for the proximity sensors and the corresponding manufacturer's guidelines.
-  Pay particular attention to frequent causes of faults that can affect both proximity sensors (cable short circuits, objects falling down from above, coding disk travel without operation, etc.).

- Proximity switches must be fitted such that the recorded signals overlap.
- Proximity switches must be fitted such that at least one is always activated.

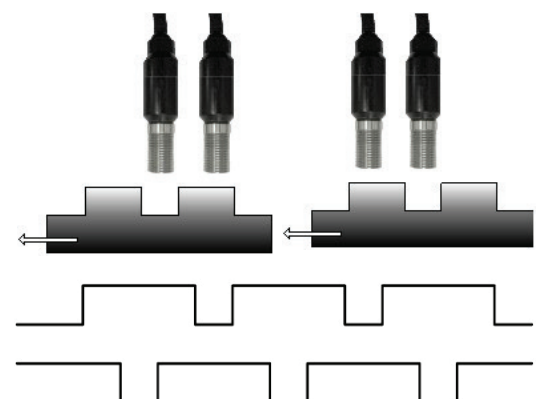

Also must apply:

- The proximity switches must be PNP type.
- The proximity switches must be NO type (Output ON when detecting metal).
- With the above conditions fulfilled, the DC value is equal to 90 %.
- The two proximity switches must be of the same model, with $MTT_F > 70$ years.







RESTART_FBK

The RESTART_FBK signal input allows the SAFEMASTER PRO to verify an EDM (External Device Monitoring) feedback signal from the external contactors (series of contacts), and to monitor Manual/Automatic operation (See the list of possible connections in the table below).

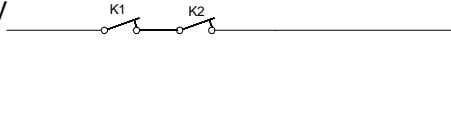
-  If the application requires it, the response time of the external contactors must be verified by an additional device.
-  The RESTART command must be installed outside the danger area in a position where the danger area and the entire work area concerned are clearly visible.
-  It must not be possible to reach the RESTART control from inside the danger area.

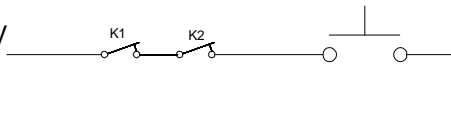
Each OSSD has a RESTART_FBK corresponding input

MODE OF OPERATION	EDM	RESTART_FBK
AUTOMATIC	With K1_K2 control	24V 
	Without K1_K2 control	24V 
MANUAL	With K1_K2 control	24V 
	Without K1_K2 control	24V 

OUTPUTS

OUT STATUS

The OUT STATUS signal is a Programmable signal output that can indicate the status of:

- An input.
- An output.
- A node of the logic diagram designed using the SAFEMASTER PRO DESIGNER software.

OUT TEST

The OUT TEST signals must be used to monitor the presence of short-circuits on the inputs.

SHORT CIRCUIT CONTROL

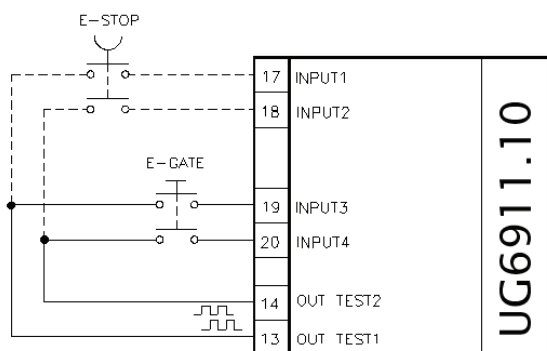

Info The maximum number of controllable inputs for each output OUT TEST is:
- 4 INPUT parallel connection

Info The maximum allowed length for OUT TEST signal connections is = 100 m

OSSD (Control unit UG 6911.10, input / output module UG 6916.10, output modules UG 6912.02, UG 6912.04)**Important notes to the safety outputs**

 The safe OSSD outputs are periodically checked for possible stuck to 0 V or + 24 V DC or for bad cabling (e.g. two OSSD outputs shorted together). The test method chosen to perform this safety check is the "voltage dip" test. Each OSSD output is periodically forced to 0 V for a very short time ($< 120 \mu\text{s}$). The UG 6911.10 periodically tests every 20 ms whereas the UG 6911.12/080 tests every 600 ms. The control brings the system into a safe state in case of inconsistent test results.

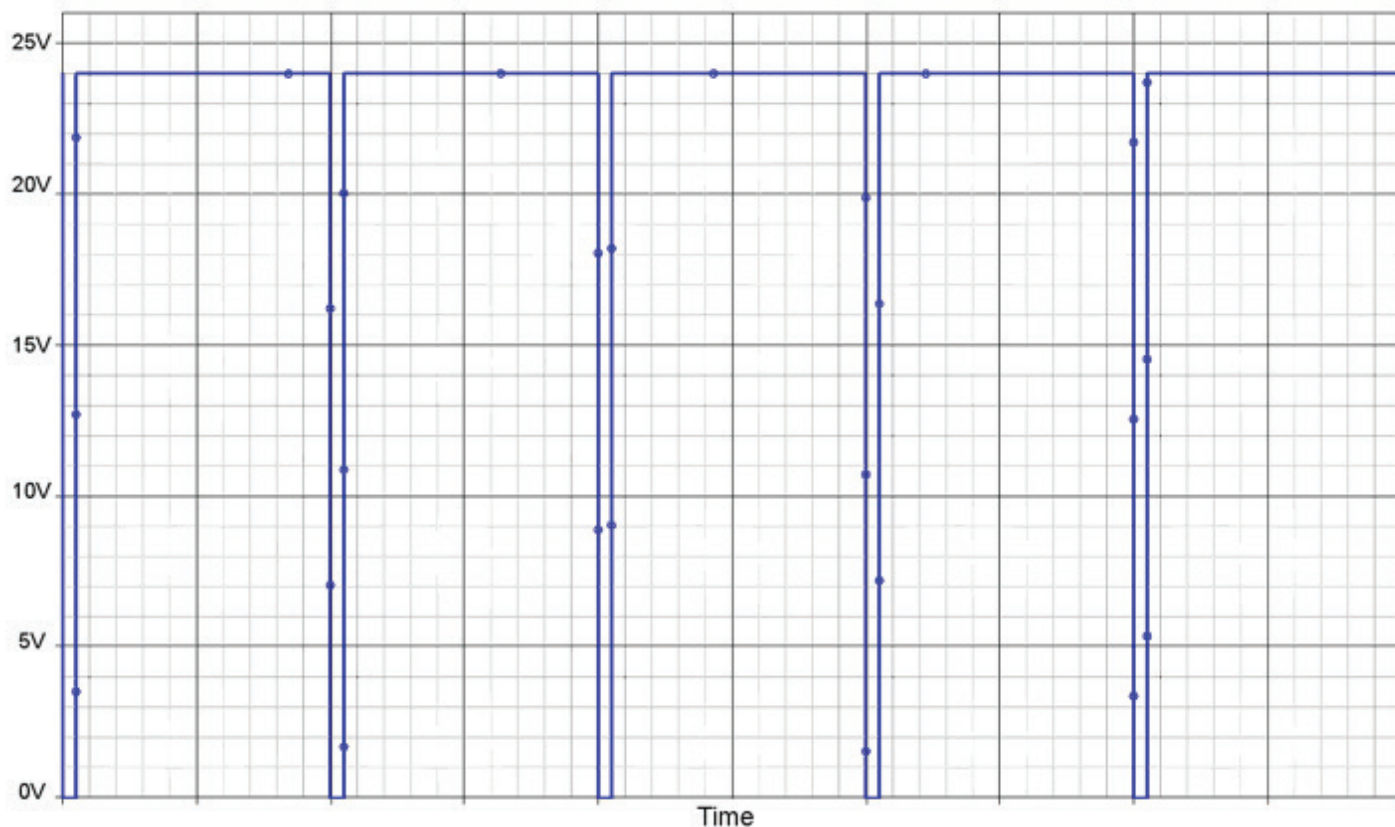

Voltage Dip Test

The modules UG 6911.10, UG 6916.10, UG 6912.02 and UG 6912.04 have OSSD (output signal switching device) outputs. These outputs are short circuit-proof, monitored for short circuits, and supply:

- In the ON condition: **$U_v - 0,75V$ to U_v** (where U_v is $24 V \pm 20 \%$)
- In the OFF condition: **0V to 2V r.m.s.**

The maximum load of 400 mA at 24 V DC, corresponds to a minimum resistive load of 60 Ω .

The maximum capacitive load is 0.68 μF . The maximum inductive load is 2 mH.

 External devices cannot be connected to the outputs unless explicitly planned in the SAFEMASTER PRO Designer program configuration.

OSSD (Control unit UG 6911.12/080, input / output module UG 6916.12/080)

The modules UG 6911.12/080 and UG 6916.12/080 are equipped with OSSD (static semiconductor safety outputs) single channel. These outputs are short circuit protected, cross circuit monitored and supply:

- In the ON condition: **$U_v - 0,75V$ to U_v** (where U_v is $24 V \pm 20 \%$)
- In the OFF condition: **0V to 2V r.m.s.**

The maximum load of 400 mA at 24 V DC, corresponds to a minimum resistive load of 60 Ω . The maximum capacitive load is 0.82 μF . The maximum inductive load is 2 mH.

Different output configurations (configurable with SAFEMASTER PRO DESIGNER software)

- 4 single channels (1 Safety Output per channel with its relative feedback input)..
- 2 dual channels (2 Safety Outputs per channel with their relative feedback input).
- 1 dual channel and 2 single channels



Using single channel OSSDs, to maintain Safety Integrity Level (SIL) 3 requirements, the OSSD outputs must be independent.



Common cause failures between OSSD outputs must be excluded by an appropriate cable installation (e.g. separate cable paths).



It is not allowed the connection of external devices to the outputs, except as expected in the configuration performed with the SAFEMASTER PRO DESIGNER software

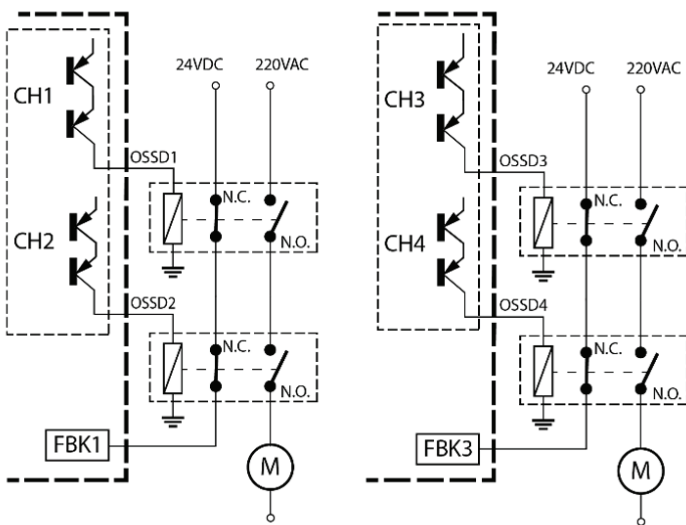
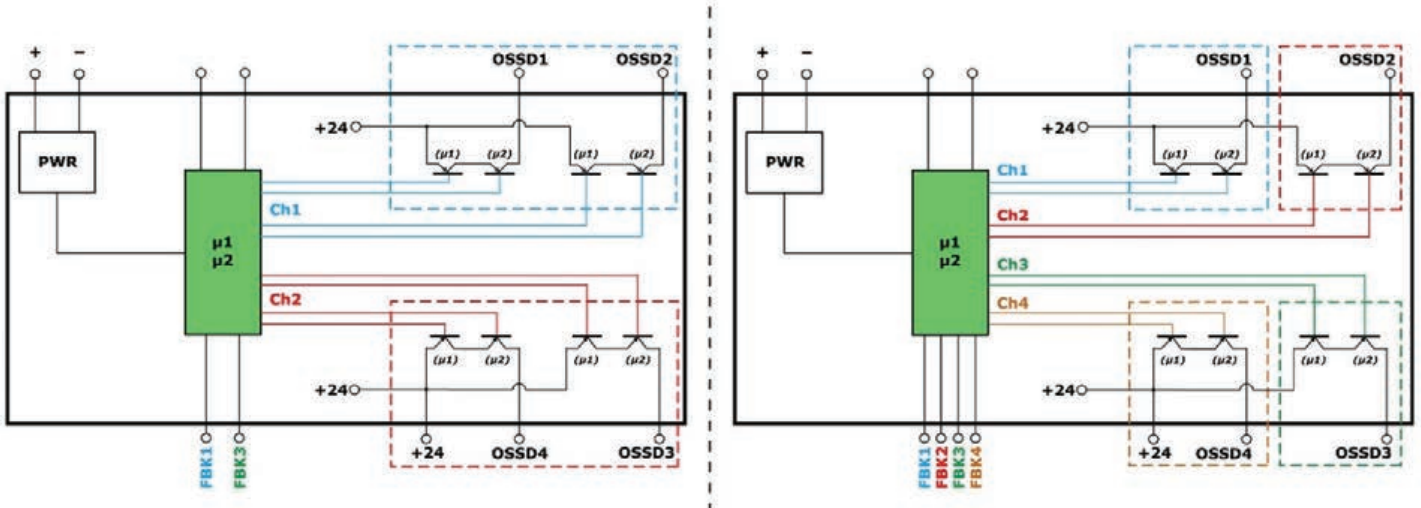

Configuration with 2 dual channel outputs
(safety category SIL3 / PL e)

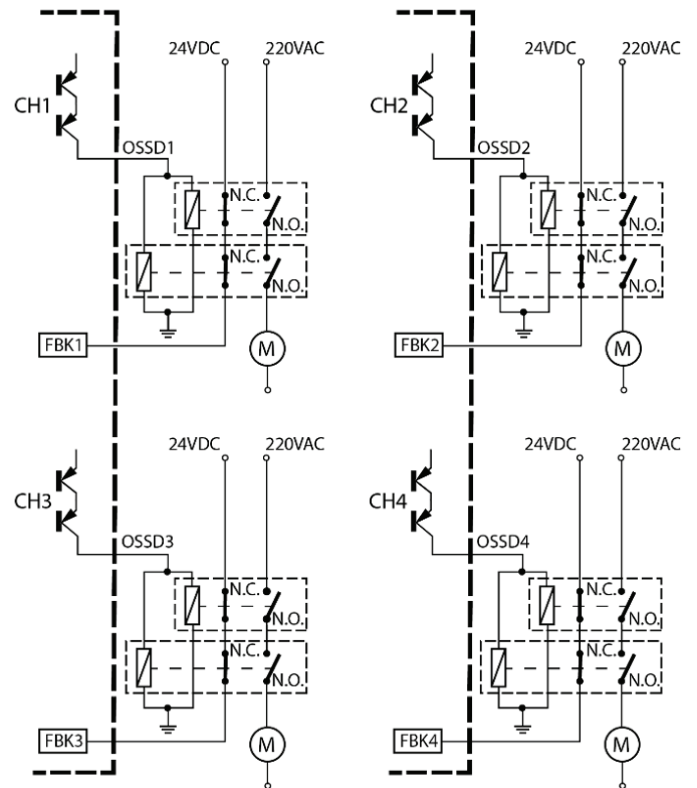

Configuration with 4 single outputs
(safety category SIL3 / PL e)

OSSD OUTPUT CONFIGURATION

Each OSSD output can be configured as shown in table below:

Automatic	The output is activated according to the configurations set by the SAFEMASTER PRO DESIGNER software only if the corresponding RESTART_FBK input is connected to 24 V DC.
Manual	The output is activated according to the configurations set by the SAFEMASTER PRO DESIGNER software only if corresponding RESTART_FBK input FOLLOWS A LOGIC TRANSITION OF 0→1.
Monitored	The output is activated according to the configurations set by the SAFEMASTER PRO DESIGNER software only if the corresponding RESTART_FBK input FOLLOWS A LOGIC TRANSITION OF 0→1→0.

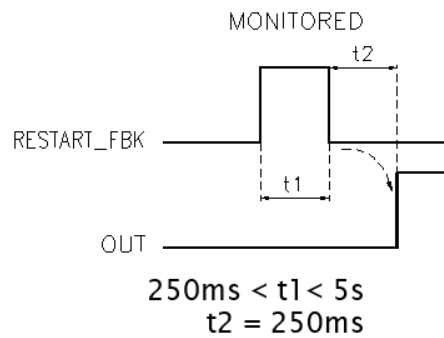
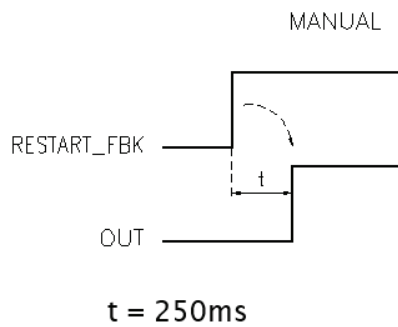

OSSD (Output module UG 6912.04/100)

The UG 6912.04/100 provides 4 High Current Safety Outputs (2 A max per channel).

These outputs are short circuit protected and supply:

- In the ON condition: $U_v - 0,6 V \dots U_v$ (24 V DC $\pm 20 \%$).
- In the OFF condition: 0 V ... 2 V r.m.s.

The maximum load of 2 A@24 V corresponds to a minimum resistance load of 12 Ω .

The maximum capacitive load is 0.82 μF . The maximum inductive load is 2.4 mH.

Different output configurations (configurable with SAFEMASTER PRO DESIGNER software)

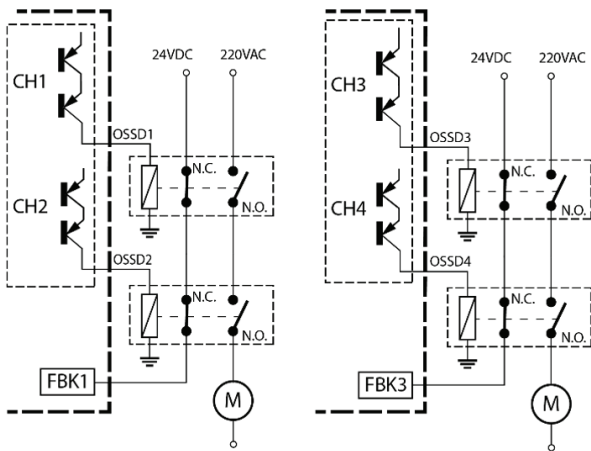
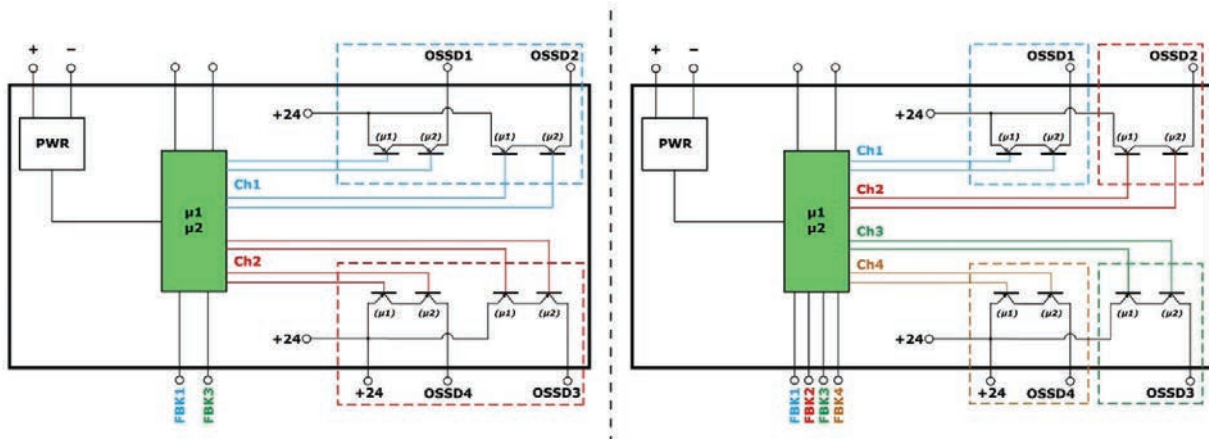

- 4 single channels (1 Safety Output per channel with its relative feedback input).
- 2 dual channels (2 Safety Outputs per channel with their relative feedback input).
- 1 dual channel and 2 single channels.

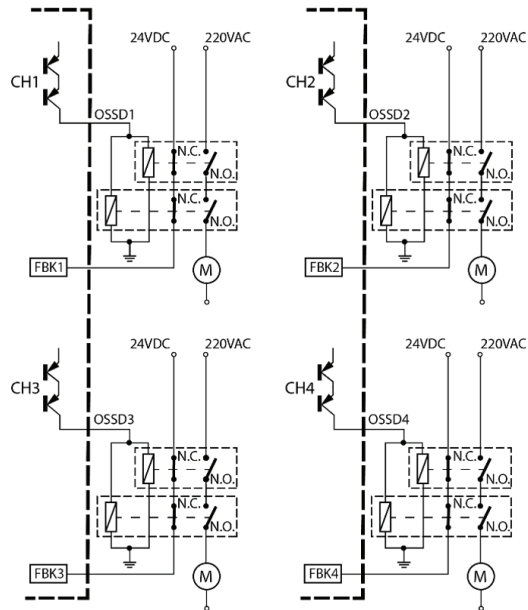

Configuration with 2 dual channel outputs
(safety category SIL3 / PL e)



Configuration with 4 single outputs
(safety category SIL3 / PL e)

-  Using single channels OSSD, to maintain Safety Integrity Level (SIL) "3" requirements the OSSD outputs must be independent.
-  Common cause failures between OSSD outputs must be excluded by observing an appropriate cable installation (i.e. separate cable paths).
-  Using an UG 6912.04/100 with sum output current > 5 A, separate them from adjacent modules by at least one housing width.

 External devices must not be connected to the outputs unless explicitly planned in the SAFEMASTER PRO Designer software configuration.

SAFETY RELAYS (MODULE UG 6912.14, UG 6912.28, UG 6914.04/000, UG 6914.04/008)

Characteristics of the output circuit

The UG 6912.14, UG 6912.28 relay modules use guided contact safety relays, each of which provides **two N.O. contacts and one N.C. contact in addition to the N.C. feedback contact.**

The UG6912.14 unit uses two safety relays and the UG6912.28 uses four

The UG 6914.04/000, UG 6914.04/008 units use four guided-contact safety relays. Each relay provides one NO contact monitored by the module logic through internal FBK contact.

 Refer to the "RELAY" section to check the possible UG 6914.04/000, UG 6914.04/008 operation modes configurable with SAFEMASTER PRO Designer software

Excitation voltage	17 ... 31 VDC
Minimum switchable voltage	10 VDC
Minimum switchable current	20 mA
Maximum switchable voltage (DC)	250 V DC
Maximum switchable voltage (AC)	400 V AC
Maximum switchable current	6 A
Response time	12 ms
Mechanical life of contacts	> 20 x 10 ⁶

 To guarantee correct isolation and avoid the risk of premature ageing of or damage to the relays, each output line must be protected using a fast 4 A fuse and the load characteristics must be consistent with those specified in the upper table.

 See the "Output module relay UG 6912.14 - UG 6912.28" section (for further details on these relays).

Output modules UG 6912.14 / UG 6912.28 internal contacts

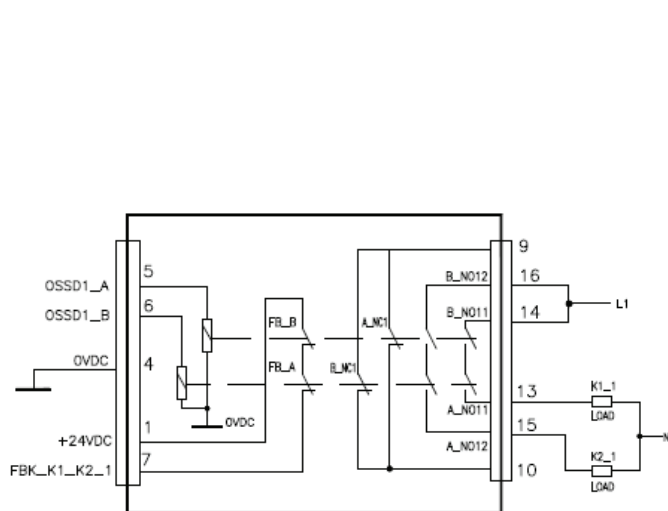

UG 6912.14

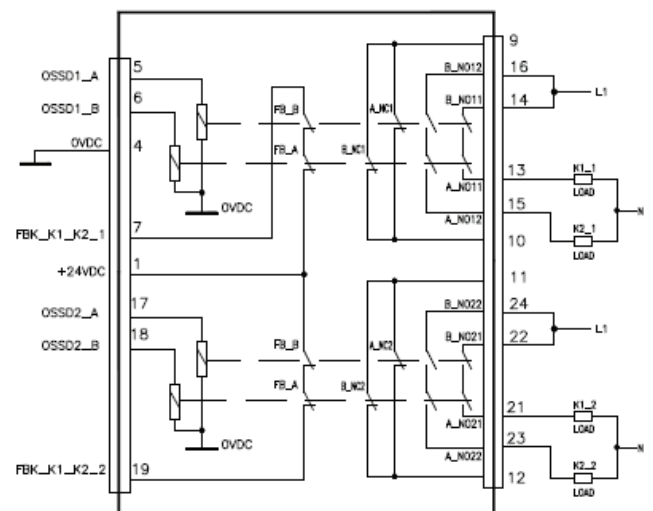

UG 6912.28

Modul connection UG 6912.14 with UG 6911.10 ²⁾

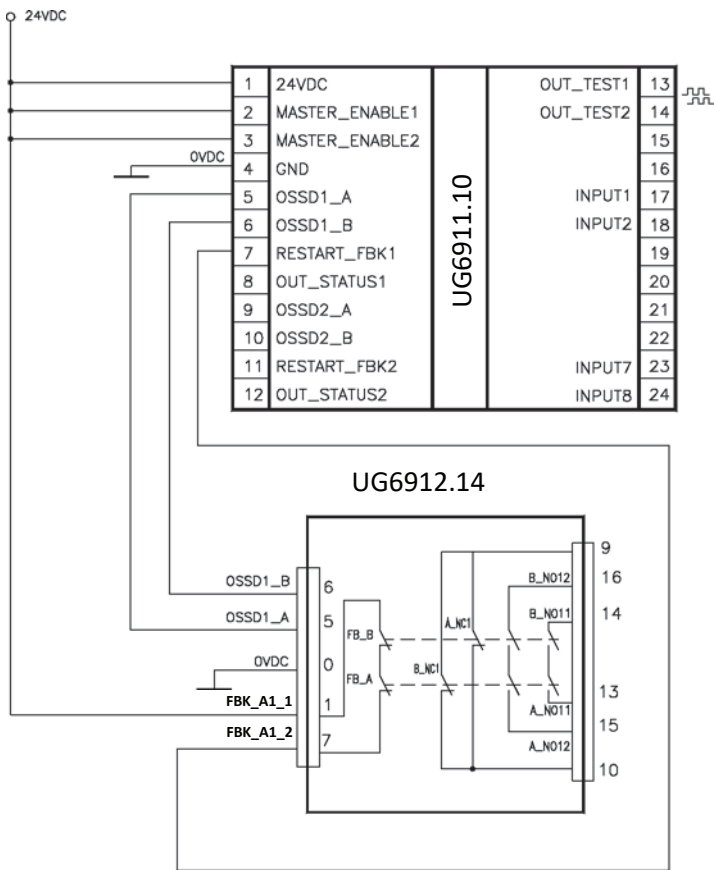

1) If a relay module UG 6912.14 oder UG 6912.28 is connected, the response time of the OSSD linked, must be increased of 12 ms

Switching operation timing diagram

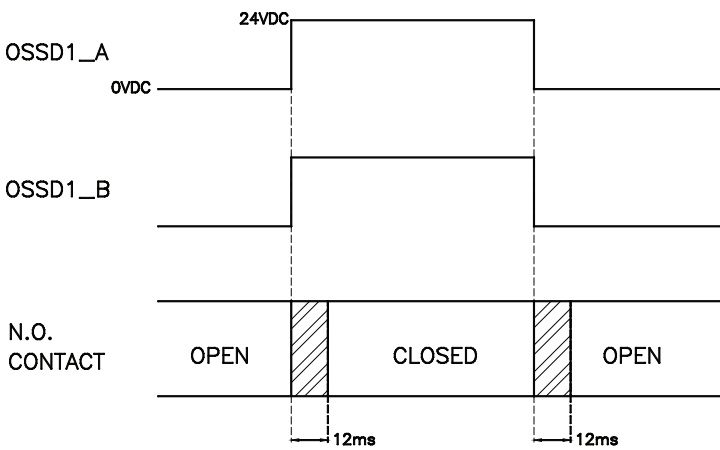

TECHNICAL FEATURES

GENERAL SYSTEM CHARACTERISTICS

Safety level Parameters

Parameters	Value	Standard
PFH _d :	See the technical data tables for each module	EN 61508: 2010
SIL:	3	
SFF:	99.8 %	
HFT:	1	
Safety standard:	Type B	
Maximum SIL:	3	IEC 62061:2021
Typ:	4	EN 61496-1:2020
PL:	e	EN 62061: 2021
DC _{avg} :	High	
MTTF _d : (years):	30 ÷ 100	
Category:	4	
Device lifetime:	20 years	
Pollution degree:	2	

General Data

Max number of inputs:	128
Max number of OSSD outputs:	16 (UG 6911.10) 32 (UG 6911.12/080)
Max. number of status outputs:	32 (UG 6911.10) 48 (UG 6911.12/080)
Max number of slave units (excluding UG 6912.14 - UG 6912.28):	14
Max number of slave units of the same type (excluding UG 6912.14 - UG 6912.28):	4
Max. number of operator function blocs:	64
Max. number of timer functions:	16
Max. number of counter functions:	16
Max. number of memory functions:	16
Max. number of muting functions:	4
Nominal voltage:	24 V DC ± 20 % / PELV, PREdective Class III; UL: Supply from class 2 (LVLE)
Digital Inputs:	„Type 2“ according to EN 61131-2 IN: 7 to 10 mA at DC 24 V
Digital Status OUTPUTS (UG 6911.10, UG 6916.10, UG 6912.02, UG 6912.04):	PNP active high – max. 100 mA at 24 V DC (per output)
OSSD (UG 6911.10, UG 6916.10, UG 6912.02, UG 6912.04):	PNP active high – max. 400 mA at 24 V DC (per output)
OSSD (UG 6912.04/100):	PNP plus schaltend – max. 2 A at 24 V DC (per OSSD)
Relay outputs (UG 6912.14, UG 6912.28, UG 6914.04/000, UG 6914.04/008):	max. 6 A at 24 V DC (per relay)

General Data

<p>Response time UG 6911.10</p> <p>This response times depends on the following Parameters:</p> <ol style="list-style-type: none"> 1) Number of slave modules installed 2) Number of operators 3) Number of OSSD outputs <p>For the right response time refer to the one calculated by the SAFEMASTER PRO DESIGNER software (Project report)</p>	UG 6911.10	10,6 ms ÷ 12,6 ms	+ TFilter_Input
	UG 6911.10 + 1 Slave	11,8 ms ÷ 26,5 ms	+ TFilter_Input
	UG 6911.10 + 2 Slaves	12,8 ms ÷ 28,7 ms	+ TFilter_Input
	UG 6911.10 + 3 Slaves	13,9 ms ÷ 30,8 ms	+ TFilter_Input
	UG 6911.10 + 4 Slaves	15 ms ÷ 33 ms	+ TFilter_Input
	UG 6911.10 + 5 Slaves	16 ms ÷ 35 ms	+ TFilter_Input
	UG 6911.10 + 6 Slaves	17 ms ÷ 37,3 ms	+ TFilter_Input
	UG 6911.10 + 7 Slaves	18,2 ms ÷ 39,5 ms	+ TFilter_Input
	UG 6911.10 + 8 Slaves	19,3 ms ÷ 41,7 ms	+ TFilter_Input
	UG 6911.10 + 9 Slaves	20,4 ms ÷ 43,8 ms	+ TFilter_Input
	UG 6911.10 + 10 Slaves	21,5 ms ÷ 46 ms	+ TFilter_Input
	UG 6911.10 + 11 Slaves	22,5 ms ÷ 48,1 ms	+ TFilter_Input
	UG 6911.10 + 12 Slaves	23,6 ms ÷ 50,3 ms	+ TFilter_Input
	UG 6911.10 + 13 Slaves	24,7 ms ÷ 52,5 ms	+ TFilter_Input
	UG 6911.10 + 14 Slaves	25,8 ms ÷ 54,6 ms	+ TFilter_Input
<p>Response time UG 6911.12/080</p> <p>This response times depends on the following Parameters:</p> <ol style="list-style-type: none"> 1) Number of slave modules installed 2) Number of operators 3) Number of OSSD outputs <p>For the right response time refer to the one calculated by the SAFEMASTER PRO DESIGNER software (Project report)</p>	UG 6911.12/080	12,75 ms ÷ 14,75 ms	+ TFilter_Input
	UG 6911.12/080 + 1 Slave	13,83 ms ÷ 37,84 ms	+ TFilter_Input
	UG 6911.12/080 + 2 Slaves	14,91 ms ÷ 40,00 ms	+ TFilter_Input
	UG 6911.12/080 + 3 Slaves	15,99 ms ÷ 42,16 ms	+ TFilter_Input
	UG 6911.12/080 + 4 Slaves	17,07 ms ÷ 44,32 ms	+ TFilter_Input
	UG 6911.12/080 + 5 Slaves	18,15 ms ÷ 46,48 ms	+ TFilter_Input
	UG 6911.12/080 + 6 Slaves	19,23 ms ÷ 48,64 ms	+ TFilter_Input
	UG 6911.12/080 + 7 Slaves	20,31 ms ÷ 50,80 ms	+ TFilter_Input
	UG 6911.12/080 + 8 Slaves	21,39 ms ÷ 52,96 ms	+ TFilter_Input
	UG 6911.12/080 + 9 Slaves	22,47 ms ÷ 55,12 ms	+ TFilter_Input
	UG 6911.12/080+ 10 Slaves	23,55 ms ÷ 57,28 ms	+ TFilter_Input
	UG 6911.12/080+ 11 Slaves	24,63 ms ÷ 59,44 ms	+ TFilter_Input
	UG 6911.12/080+ 12 Slaves	25,71 ms ÷ 61,60 ms	+ TFilter_Input
	UG 6911.12/080+ 13 Slaves	26,79 ms ÷ 63,76 ms	+ TFilter_Input
	UG 6911.12/080+ 14 Slaves	27,87 ms ÷ 65,92 ms	+ TFilter_Input
Unit connection UG 6911.10, UG 6911.12/080	proprietary 5-pole DOLD IN-RAIL-BUS		
Plug in terminal blocks with screw terminals Max. cross section for connection:	1 x 0,25 ... 2,5 mm ² solid or stranded ferruled (isolated) or 2 x 0,25 ... 1 mm ² solid or stranded ferruled (isolated)		
Insulation of wires or sleeve length:	7 mm		
Wire fixing	Captive slotted screw M3		
Fixing torque:	0,5 ... 0,6 Nm		
Max length of connections:	100 m		
Operating temperature:	-10 ÷ 55 °C		
Storage temperature:	-20 ÷ 85 °C		
Relative humidity:	10 % ÷ 95 %		
Altitude:	2,000 m		
UL-Data:	The safety functions were not evaluated by UL. Listing is accomplished according to requirements of Standard UL 508, "general use applications"		
UL-Notes:	For use in Pollution degree 2, overvoltage category II environment only		
Max. ambient temperatur:	55 °C		
Wire connection:	60 °C / 75 °C copper conductors onl AWG 30 ÷ 12 (solid / stranded) Torque 5-7 lb-in		



TFilter_Input = max filtering time from among those set on project inputs (see "INPUT OBJECTS" section").



ENCLOSURE

Description:	Electronic housing max 24 pole, with locking latch mounting
Enclosure material:	Polyamid
Enclosure pREDection class:	IP 40
Terminal blocks pREDection class:	IP 20
Fastening:	Quick coupling to rail according to EN 60715
Dimensions mm (H x W x D):	109 x 22,5 x 120,3

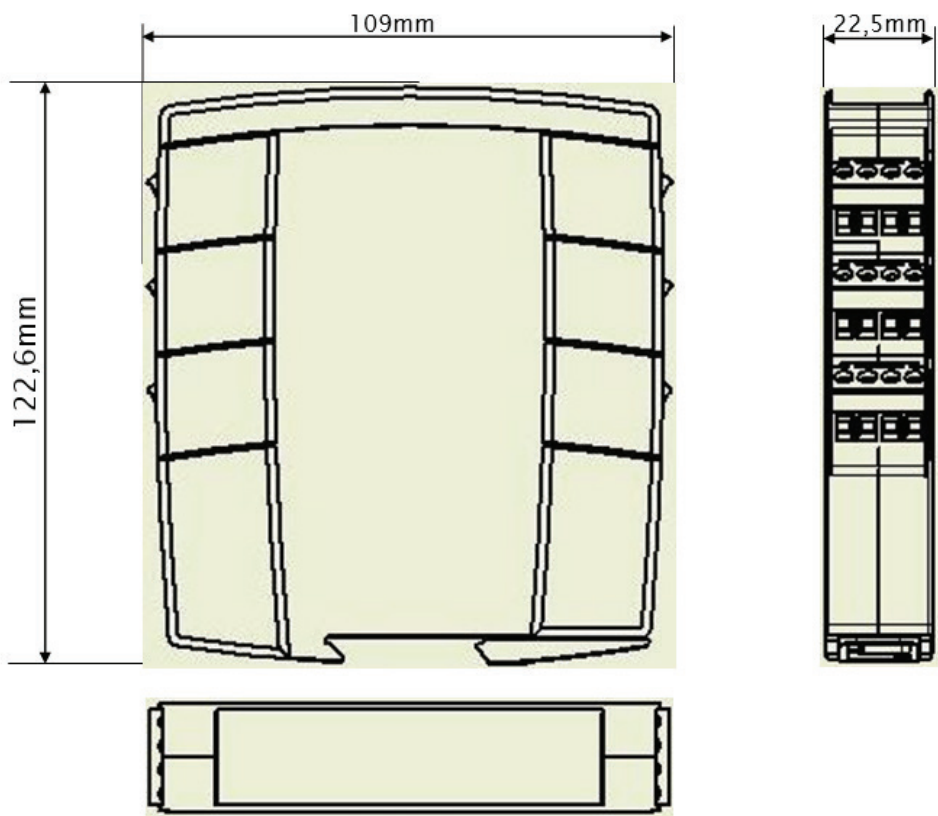
Mechanical dimensions





CONTROL UNIT UG 6911.10

SFF:	(EN 61508:2 nd edition)	99.8 %
PFH _d :		6.86E-9
MTTF _d :	EN ISO 13849-1: 2008	437.63
DC _{avg} :		99.0 %
Nominal voltage:	24 V DC ± 20 % / PELV, PREdective Class III; UL: Supply from class 2 (LVLE)	
Nominal consumption:	Max. 3 W	
Unit enable inputs ENABLE (No. / description):	2 / „Type 2“ acc. to EN 61131-2 IN: 7 to 10 mA at DC 24 V	
Digital safety inputs (No. / description):	8 / „Type 2“ acc. to EN 61131-2 IN: 7 to 10 mA at DC 24 V	
Test output (No./ description):	4 / to check for short-circuits - overloads	
Digital status outputs (No. / description):	2 / programmable - PNP active high, max. 100 mA at 24 V DC	
OSSD (No. / description):	2 pairs / solid state safety outputs PNP active high, max. 400 mA at 24 V DC	
Input FBK/RESTART (No. / description):	2 / EDM control / possible Automatic or Manual operation with RESTART button „Type 2“ acc. to EN 61131-2, IN: 7 to 10 mA at DC 24 V	
Slot for OA 6911 card:	Available	
Connection to PC:	USB 2.0 (Hi Speed) – Max. cable length: 3 m	
Connection to slave units:	Proprietary 5-pole DOLD IN-RAIL-BUS	
Weight:	190 g	
Approvals:	 	

CONTROL UNIT UG 6911.12/080

SFF:	(EN 61508:2 nd edition)	99,8%
PFH _d :		1.35E-8
MTTF _d :	EN ISO 13849-1: 2008	161,01
DC _{avg} :		99,0%
Nominal voltage:	24 V DC ± 20 %	
Nominal consumption:	Max. 3 W	
Digital safety inputs (No. / description):	8 / „Type 2“ acc. to EN 61131-2 IN: 7 to 10 mA at DC 24 V	
Test output (No. / description):	4 / to check for short-circuits - overloads	
Digital status outputs (No. / description):	4 / programmable - PNP active high, max. 100 mA at 24 V DC	
OSSD (No. / description):	4 single (or 2 double channel), Cat.4 400 mA at 24 V DC max. - Interface type C class 3 (ZVEI CB24I)	
Input FBK/RESTART (No. / description):	4 / EDM control / possible Automatic or Manual operation with RESTART button „Typ 2“ acc. to EN 61131-2, IN: 7 to 10 mA at DC 24 V	
Slot for OA 6911 card:	Available	
Connection to PC:	USB 2.0 (Hi Speed) - Max. cable length: 3 m	
Connection to slave units:	Proprietary 5-pole DOLD IN-RAIL-BUS	
Weight:	190 g	
Approvals:		



INPUT / OUTPUT MODULE UG 6916.10

SFF:	(EN 61508: 2 nd edition)	99.8 %
PFH _d :		5.68E-9
MTTF _d :		458.21
DC _{avg} :		99.0 %
Nominal voltage:	24 V DC ± 20 % / PELV, PREdective Class III; UL: Supply from class 2 (LVLE)	
Nominal consumption:	Max. 3 W	
Digital safety inputs (No. / description):	8 / „Type 2“ acc. to EN 61131-2 IN: 7 to 10 mA at DC 24V	
Inputs for Node selection NODE_SEL0/1 (No. / description):	2 / „Type 2“ acc. to EN 61131-2 IN: 7 to 10 mA at DC 24V	
Test output (No. / description):	4 / to check for short-circuits - overloads	
Digital status outputs (No. / description):	2 / programmable - PNP active high; max. 100 mA at 24 V DC	
OSSD (No. / description):	2 pairs / solid state safety outputs PNP active high; max. 400 mA at 24 V DC	
Input FBK/RESTART (No. / description):	2 / EDM control / possible Automatic or Manual operation with RESTART button „Type 2“ acc. to EN 61131-2, IN: 7 to 10 mA at DC 24 V	
Connection to control unit:	Proprietary 5-pole DOLD IN-RAIL-BUS	
Weight:	190 g	
Approvals:	 	

INPUT / OUTPUT MODULE UG 6916.12/080

SFF:	(EN 61508: 2 nd edition)	99,7%
PFH _d :		1.32E-8
MTTF _d :		166,47
DC _{avg} :		99,0%
Nominal voltage:	24 V DC ± 20 %	
Nominal consumption:	Max. 3 W	
Digital safety inputs (No. / description):	8 / „Type 2“ acc. to EN 61131-2 IN: 7 to 10 mA at DC 24 V	
Inputs for Node selection NODE_SEL0/1 (No. / description):	2 / „Type 2“ acc. to EN 61131-2 IN: 7 to 10 mA at DC 24 V	
OUTPUT Test (No. / description):	4 / to check for short-circuits - overloads	
Digital status outputs (No. / description):	4 / rogrammable - PNP active high, max. 100 mA at 24 V DC	
OSSD (No. / description):	4 single (or 2 dual channel), Cat.4: PNP active high – max. 400 mA at 24 V DC; Schnittstelle Typ C Klasse 3 (ZVEI CB24I)	
Connection to control unit:	Proprietary 5-pole DOLD IN-RAIL-BUS	
Weight:	190 g	
Approvals:		



INPUT MODULE UG 6913.08 AND UG 6913.16

Type:		UG 6913.08	UG 6913.16
SFF:	(EN 61508: 2 nd edition)	99.7 %	99.7 %
PFH _d :		4.45E-9	4.94E-9
MTTF _d :	EN ISO 13849-1: 2008	473.00	396.47
DC _{avg} :		99.0 %	99.0 %
Nominal voltage:	24 V DC ± 20 % / PELV, PREdective Class III; UL: Supply from class 2 (LVLE)		
Nominal consumption:	Max. 3 W		
Inrush current:	Max. 7 A, 0.3 ms		
Digital safety inputs (No. / description):		8	16
	„Type 2“ acc. to EN 61131-2 IN: 7 to 10 mA at DC 24 V		
Inputs for Node selection NODE_SEL0/1 (No. / description):	2 / „Type 2“ acc. to EN 61131-2 IN: 7 to 10 mA at DC 24 V		
Test output (No. / description):	4 / to check for short-circuits - overloads max. number of inputs for each output:		
		2	4
Connection to control unit:	Proprietary 5-pole DOLD IN-RAIL-BUS		
Weight:	190 g		
Approvals:	 		

INPUT MODULE UG 6913.12

SFF:	(EN 61508: 2 nd edition)	99.7 %
PFH _d :		5.56E-9
MTTF _d :	EN ISO 13849-1: 2008	326.05
DC _{avg} :		99.0 %
Nominal voltage:	24 V DC ± 20 % / PELV, PREdective Class III; UL: Supply from class 2 (LVLE)	
Nominal consumption:	Max. 3 W	
Inrush current:	Max. 7A, 0.3 ms	
Digital safety inputs (No. / description):	12 / „Type 2“ acc. to EN 61131-2 IN: 7 bis 10 mA at DC 24 V	
Inputs for Node selection NODE_SEL0/1 (No. / description):	2 / „Type 2“ acc. to EN 61131-2 IN: 7 bis 10 mA at DC 24 V	
Test output (No. / description):	8 / to check for short-circuits - overloads; max. number of inputs for each output: 2	
Connection to control unit:	Proprietary 5-pole DOLD IN-RAIL-BUS	
Weight:	190 g	
Approvals:		

OUTPUT MODULE OSSD UG 6912.02 AND UG 6912.04

Type:		UG 6912.02	UG 6912.04
SFF:	(EN 61508: 2 nd edition)	99.8 %	99.8 %
PFH _d :		4.09E-9	5.84E-9
MTTF _d :	EN ISO 13849-1: 2008	948.88	683.38
DC _{avg} :		98.9 %	99 %
Nominal voltage:	24 V DC ± 20 % / PELV, PREDeactive Class III; UL: Supply from class 2 (LVLE)		
Nominal consumption:	Max. 3 W		
Inrush current:	Max. 10 A, 0.3 ms		
Digital status outputs (No. / description):	2		4
	Programmable - PNP active high, max. 100 mA at 24 V DC		
Inputs for Node selection NODE_SEL0/1 (No. / description):	2 / „Type 2“ acc. to EN 61131-2 IN: 7 to 10 mA at DC 24 V		
OSSD (No. / description)	2		4
	Solid state safety outputs: PNP active high; max. 400 mA at 24 V DC		
Input FBK/RESTART (No. / description):	2		4
	EDM control / possible Automatic or Manual operation with RESTART button „Typ 2“ acc. to EN 61131-2, IN: 7 to 10 mA at DC 24 V		
Connection to control unit:	Proprietary 5-pole DOLD IN-RAIL-BUS		
Weight:	190 g		
Approvals:	 		

OUTPUT MODULE OSSD UG 6912.04/100

SFF:	(EN 61508: 2 nd edition)	99,9%
PFH _d :		8.64E-9
MTTF _d :	EN ISO 13849-1: 2008	395,20
DC _{avg} :		99,1%
Nominal voltage:	24 V DC ± 20 % / PELV, PREDeactive Class III; UL: Supply from class 2 (LVLE)	
Nominal consumption:	Max. 4 W	
OSSD output current	Max. 2 A per channel *)	
Number of safety outputs (OSSD):	4 single channels (or 2 dual channels), Cat. 4	
Input FBK/RESTART (No. / description):	4 / EDM control / possible Automatic or Manual operation with RESTART button „Type 2“ acc. to EN 61131-2, IN: 7 to 10 mA at DC 24 V	
Digital outputs (No. / description):	8 / programmable output / PNP active high	
Response time:	12 ms	
Connection to control unit:	Proprietary 5-pole DOLD IN-RAIL-BUS	
Weight:	190 g	
Approvals:		

*) Using UG 6912.04/100 modules with current output > 500 mA separate them from adjacent modules by at least one housing width

OUTPUT MODULE RELAY UG 6912.14 AND UG 6912.28

PFH_d computation has been done under the following assumptions:

h_{op} in hours per day: 16

d_{op} in days per year: 220

t_{Cycle1}: 300 s (one commutation every 5 minutes)

t_{Cycle2}: 3600 s (one commutation every hour)

t_{Cycle3}: 24 std (one commutation every day)



Taking in account that the Relay feedback contact connection has been done as described in section *EXAMPLE OF CONNECTION TO THE MACHINE CONTROL SYSTEM*, every dual channel connected to SAFEMASTER PRO module has the following safety values (PFH_d, SFF acc. to EN 61508, MTTF_d and DC_{avg} acc. to EN ISO13849-1):

FEEDBACK contact present:

PFH _d :	SFF	MTTF _d	DC _{avg}		
3.09 e ⁻¹⁰	99.6 %	2335.94	98.9 %	t _{cycle1}	DC 13 (2 A)
8.53 e ⁻¹¹	99.7 %	24453.47	97.7 %	t _{cycle2}	
6.63 e ⁻¹¹	99.8 %	126678.49	92.5 %	t _{cycle3}	
8.23 e ⁻⁰⁹	99.5 %	70.99	99.0 %	t _{cycle1}	AC 15 (3 A)
7.42 e ⁻¹⁰	99.5 %	848.16	99.0 %	t _{cycle2}	
1.07 e ⁻¹⁰	99.7 %	12653.85	98.4 %	t _{cycle3}	
3.32 e ⁻⁰⁹	99.5 %	177.38	99.0 %	t _{cycle1}	AC 15 (1 A)
3.36 e ⁻¹⁰	99.6 %	2105.14	98.9 %	t _{cycle2}	
8.19 e ⁻¹¹	99.7 %	28549.13	97.5 %	t _{cycle3}	

FEEDBACK contact missing

PFH _d :	SFF	MTTF _d	DC _{avg}		
9.46 e ⁻¹⁰	60 %	2335.93	0	t _{cycle1}	DC 13 (2 A)
1.08 e ⁻¹⁰	87 %	24453.47	0	t _{cycle2}	
6.75 e ⁻¹¹	97 %	126678.5	0	t _{cycle3}	
4.60 e ⁻⁰⁷	50 %	70.99	0	t _{cycle1}	AC 15 (3 A)
4.49 e ⁻⁰⁹	54 %	848.15	0	t _{cycle2}	
1.61 e ⁻¹⁰	79 %	12653.85	0	t _{cycle3}	
7.75 e ⁻⁰⁸	51 %	177.37	0	t _{cycle1}	AC 15 (1 A)
1.09 e ⁻⁰⁹	60 %	2105.14	0	t _{cycle2}	
1.00 e ⁻¹⁰	88 %	28549.13	0	t _{cycle3}	

Gerätetyp:	UG 6912.14	UG 6912.28
Nominal voltage:	24 V DC ± 20 % / PELV, PREdective Class III; UL: Supply from class 2 (LVLE)	
Nominal consumption:	Max. 3 W	
Switching voltage:	240 V AC	
Minimum switching voltage	10 V DC	
Switching current:	Max. 6 A	
Minimum switching current:	20 mA	
Contacts:	2 NO contacts + 1 NC contact	2 x (2 NO contacts + 1 NC contact)
FEEDBACK-Contacts:	1	2
Response time:	12 ms	
Mechanical life:	> 20 x 10 ⁶	
B10 _d :	AC15 230 V:	I = 3 A: 300,000 I = 1 A: 750,000
	DC13 24 V:	I ≤ 2 A: 10,000,000
Connection to output unit:	Via front-panel terminal strip; (no connection via IN-RAIL-BUS)	
Control inputs OSSD1_A, OSSD1_B, OSSD2_A, OSSD2_B:	IN: max. 30 mA at DC 24 V	
UL-Data, Switching capacity:	Each relay output: 250 V, 6 A, resistive	
Weight:	180 g	230 g
Approvals:	 	

OUTPUT MODULE RELAY UG 6914.04/000 AND UG 6914.04/008

Type::		UG 6914.04/000	UG 6914.04/008
SFF:	EN 61508: 2 nd edition	99.9 %	99.9 %
PFH _d :		2.90E-9	2.94E-9
DC _{avg} :	EN ISO 13849-1: 2008	99.0 %	98.9 %
MTTF _d :		998.56	980.78
Nominal voltage:		24 V DC ± 20 % / PELV, PREdective Class III; UL: Supply from class 2 (LVLE)	
Nominal consumption:		Max. 3 W	
Switching voltage:		240 V AC	
Minimum switching voltage		10 V DC	
Switching current:		Max. 6 A	
Minimum switching current:		20 mA	
Contacts:		4 NO contacts	
Input FBK/RESTART (No. / description):		EDM control / possible Automatic or Manual operation with RESTART button „Type 2“ acc. to EN 61131-2, IN: 7 to 10 mA at DC 24 V	
Response time:		Response time (UG 6911, UG 6912, UG 6916) + 12 ms	
Mechanical life:		> 20 x 10 ⁶	
B10 _d :	AC15 230V:	I = 3 A: 300,000 I = 1 A: 750,000	
	DC13 24V:	I ≤ 2 A: 10,000,000	
Digital status outputs (No. / description):		0	8
		Programmable - PNP active high; max. 100 mA at 24 V DC	
Connection to control unit		Proprietary 5-pole DOLD IN-RAIL-BUS	
UL-Data, Switching capacity:		Each relay output: 250 V, 6 A, resistive	
Weight:		250 g	250 g
Approvals:			

Comment:

For each Relay output must be added to the previous PFH_d a value that depends on the load of the relay and its switching frequency.

In addition, the PL obtained from the Relay outputs changes depending on the configuration chosen by the user. We assume N_{op} defines the number of commutations / year

OUTPUT MODULE RELAY UG 6914.04/000 AND UG 6914.04/008**Relay Category 1**

PL maximum obtainable: c
Maximum achievable SIL: 1

PFH _d	Bedingungen
$PFH_d = \frac{N_{op}}{2.63E10}$	AC 15, Last: 3 A at 230 V AC
$PFH_d = \frac{N_{op}}{6.57E10}$	AC15, Last: 1 A at 230 V AC
$PFH_d = \frac{N_{op}}{8.77E11}$	DC13, Last: 2 A at 24 V DC

Relay Category 2

PL maximum obtainable: d
Maximum achievable SIL: 2

PFH _d	Conditions
$PFH_d = \frac{N_{op}}{2.63E11}$	AC 15, Load: 3 A at 230 V AC
$PFH_d = \frac{N_{op}}{6.57E11}$	AC15, Load: 1 A at 230 V AC
$PFH_d = \frac{N_{op}}{8.77E12}$	DC13, Load: 2 A at 24 V DC

Relay Category 4

PL maximum obtainable: e
Maximum achievable SIL: 3

PFH _d	Conditions
$PFH_d = \frac{N_{op}}{6.62E11} + \frac{N_{op}}{3.92E19}$	AC 15, Load: 3 A at 230 V AC
$PFH_d = \frac{N_{op}}{1.65E12} + \frac{N_{op}}{2.45E20}$	AC15, Load: 1 A at 230 V AC
$PFH_d = \frac{N_{op}}{2.22E13} + \frac{N_{op}}{4.36E22}$	DC13, Load: 2 A at 24 V DC

MTTF_d for all relay outputs (MTTF_{dTOT})

For each Relay output the previous MTTF_d must be added to a value that depends on the load of the relay and its switching frequency according to the following formula:

$$MTTF_{dTOT} = \frac{1}{(1/MTTF_d) + (1/MTTF_{d1})}$$

MTTF _{d1} (Jahr)	Conditions
$MTTF_{d1} = \frac{3.0E6}{N_{op}}$	AC 15, Load: 3 A at 230 V AC
$MTTF_{d1} = \frac{7.5E6}{N_{op}}$	AC15, Load: 1 A at 230 V AC
$MTTF_{d1} = \frac{1.0E8}{N_{op}}$	DC13, Load: 2 A at 24 V DC

OUTPUT MODULE RELAY UG 6914.04/000 AND UG 6914.04/008

PFH_d and MTTF_d computation under the following assumptions:

h_{op} in hours per day: 16

d_{op} dop in days per year: 220

t_{Cycle1}: 300 s (one commutation every 5 minutes)

t_{Cycle2}: 3600 s (one commutation every hour)

t_{Cycle3}: 24 std (one commutation every day)

UG 6914.04/000				
AC 15; 3 A at 230 V AC				
PFH _d				
Rel. Cat. 1	Rel. Cat. 2	Rel. Cat. 4	MTTF _d	
1.61E-06	1.64E-07	6.68E-08	66.31	Cycle 1
1.37E-07	1.63E-08	8.22E-09	459.82	Cycle 2
1.13E-08	3.74E-09	3.23E-09	930.43	Cycle 3
AC 15; 1 A at 230 V AC				
PFH _d				
Rel. Cat. 1	Rel. Cat. 2	Rel. Cat. 4	MTTF _d	
6.46E-07	6.72E-08	2.85E-08	150.75	Cycle 1
5.65E-08	8.26E-09	5.03E-09	679.91	Cycle 2
6.25E-09	3.23E-09	3.03E-09	970.14	Cycle 3
DC 13; 2 A at 24 V DC				
PFH _d				
Rel. Cat. 1	Rel. Cat. 2	Rel. Cat. 4	MTTF _d	
5.11E-08	7.72E-09	4.80E-09	702.33	Cycle 1
6.91E-09	3.31E-09	3.01E-09	964.65	Cycle 2
3.15E-09	2.93E-09	2.91E-09	996.37	Cycle 3

UG 6914.04/008				
AC 15; 3 A at 230 V AC				
PFH _d				
Rel. Cat. 1	Rel. Cat. 2	Rel. Cat. 4	MTTF _d	
1.61E-06	1.64E-07	6.68E-08	66.23	Cycle 1
1.37E-07	1.63E-08	8.26E-09	456.01	Cycle 2
1.13E-08	3.78E-09	3.27E-09	914.97	Cycle 3
AC 15; 1 A at 230 V AC				
PFH _d				
Rel. Cat. 1	Rel. Cat. 2	Rel. Cat. 4	MTTF _d	
6.46E-07	6.72E-08	2.85E-08	150.34	Cycle 1
5.65E-08	8.30E-09	5.07E-09	671.62	Cycle 2
6.29E-09	3.27E-09	3.07E-09	953.35	Cycle 3
DC 13; 2 A at 24 V DC				
PFH _d				
Rel. Cat. 1	Rel. Cat. 2	Rel. Cat. 4	MTTF _d	
5.11E-08	7.76E-09	4.84E-09	693.48	Cycle 1
6.95E-09	3.34E-09	3.10E-09	948.05	Cycle 2
3.19E-09	2.97E-09	2.95E-09	978.67	Cycle 3

SPEED MONITORING MODULE UG 6917

Type:		UG 6917/002	UG 6917/102	UG 6917/112	UG 6917/202	UG 6917/222	UG 6917/302	UG 6917/332
SFF:	EN 61508:	99.7 %	99.7 %	99.7 %	99.7 %	99.7 %	99.7 %	99.7 %
	2 nd edition	5.98E-9	7.08E-9	8.18E-9	6.70E-9	7.42E-9	7.93E-9	9.89E-9
PFH _d :								
MTTF _d :	EN ISO	500.33	337.72	254.88	380.05	306.40	269.49	184.41
DC _{avg} :	13849-1:2008	99.0 %	99.0 %	99.0 %	99.0 %	99.0 %	99.0 %	99.0 %

Type:	UG 6917/002	UG 6917/x02	UG 6917/xx2
Nominal voltage:	24 V DC ± 20 % / PELV, PREDeictive Class III; UL: Supply from class 2 (LVLE)		
Nominal consumption:	Max. 3 W		
Max. number of axis:	2		
Input impedance:	-	120 Ohm (Type 102 /112) 120 Ohm (Type 302 /332)	
Encoder interface:	-	TTL (Type /102 /112) HTL (Type /202 /222) sin / cos (Type /302 /332)	
Encoder input signals electrically insulated acc. to Norm EN 61800-5:	Rated insulation voltage 50 V Overvoltage category II Rated impulse withstand voltage 4.00 kV		
Max. number of encoders:	0	1	2
Max. encoder frequency:	-	500 KHz (HTL: 300 KHz)	
Encoder connections:	-	RJ45	
Encoder adjustable threshold range:	-	1 Hz – 450 kHz	
Max. number of proximity:	2		
Max. proximity frequency:	5 KHz		
Proximity adjustable threshold range:	1 Hz – 4 kHz		
Standstill / overspeed frequency gap:	> 10 Hz		
Min. gap between thresholds (with thresholds >1):	> 5 %		
Proximity connections:	AnschlussTERMINALn		
Proximity type:	PNP / NPN, 3 / 4 Drähte		
Connection to control unit:	Proprietary 5-pole DOLD IN-RAIL-BUS		
Weight:	200 g		
Approvals:			

OUTPUT MODULES SIGNAL UG 6915/008 AND UG 6915/016

Type:	UG 6915/008	UG 6915/016
Nominal voltage:	24 V DC ± 20 % / PELV, PREDeactive Class III; UL: Supply from class 2 (LVLE)	
Nominal consumption:	max. 3 W	
Digitale status outputs (No. / description):	8	16
	Programmable - PNP active high; max. 100 mA at 24 V DC	
Connection to control unit:	Proprietary 5-pole DOLD IN-RAIL-BUS	
Weight:	200 g	200 g
Approvals:		

BUSEXTENDER MODULE UG 6918

Nominal voltage:	24 V DC ± 20 % / PELV, PREDeactive Class III; UL: Supply from class 2 (LVLE)
Nominal consumption:	Max. 3 W
Inrush current:	Max. 10 A, 0.3 ms
Connections:	Proprietary 5-pole DOLD IN-RAIL-BUS, 4-polige TERMINALn
Max. distance between 2 modules of UG 6918:	< 50 m (each section)
Max. number of sections:	6
Fieldbus Module:	The possible fieldbus module present in the system can only be placed to control unit UG 6911.10
Weight:	180 g
Approvals:	

Cable for BusExtendermodul UG 6918

Maximum length	< 50 m
Conductors	2 twisted pairs of conductors with shield
Nominal impedance:	120 Ω
Nominal capacitance	< 42 pf / m
Nominal resistance	< 95 mΩ / m

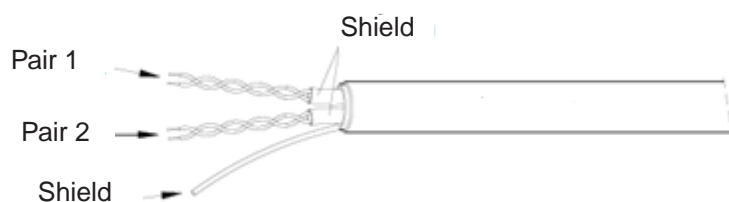

VISUALISATIONS

CONTROL UNIT UG 6911.10

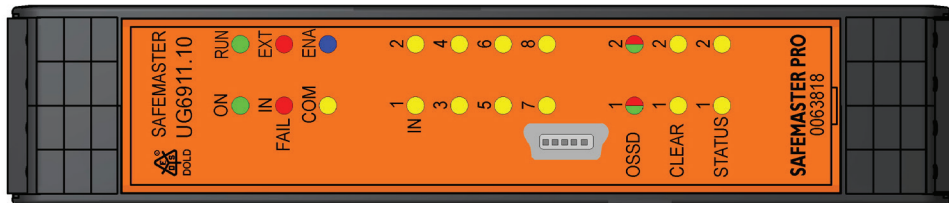

UG 6911.10

MEANING	LED								
	RUN GREEN	IN FAIL RED	EXT FAIL RED	COM ORANGE	ENA BLUE	IN1÷8 YELLOW	OSSD1÷2 RED / GREEN	CLEAR1÷2 YELLOW	STATUS1÷4 YELLOW
Power on - initial TEST	ON	ON	ON	ON	ON	ON	RED	ON	ON
OA 6911 recognized	OFF	OFF	OFF	ON (max 1s)	ON (max. 1s)	OFF	RED	OFF	OFF
Writing / Loading diagram to / from OA 6911 card	OFF	OFF	OFF	Flashing 5 times	Flashing 5 times	OFF	RED	OFF	OFF
SAFEMASTER PRO error: Internal configuration not present	OFF	OFF	OFF	Slow Flashing	OFF	OFF	RED	OFF	OFF
SAFEMASTER PRO error: Slave module or node number not correct (ref. System composition)	OFF	OFF	OFF	Fast Flashing	OFF	OFF	RED	OFF	OFF
SAFEMASTER PRO error: Slave module missing or not ready (ref. System composition)	Fast Flashing 12 times	OFF	OFF	Fast Flashing 12 times	OFF	OFF	RED	OFF	OFF
SAFEMASTER PRO DESIGNER connected, control unit UG 6911 stopped	OFF	OFF	OFF	ON	OFF	OFF	RED	OFF	OFF

Opening Screen

MEANING	LED								
	RUN GREEN	IN FAIL RED	EXT FAIL RED	COM ORANGE	IN1÷8 YELLOW	ENA BLUE	OSSD1÷2 RED / GREEN	CLEAR1÷2 YELLOW	STATUS1÷2 YELLOW
NORMAL OPERATION	ON	OFF	OFF Op.OK	ON = UG 6911.10 connected to PC OFF = otherwise	INPUT condition	ON MASTER_ENABLE1 and MASTER_ENABLE2 active OFF MASTER_ENABLE1 or MASTER_ENABLE2 inactive	RED with output OFF GREEN with output ON	ON Waiting for RESTART Flashing NO Feedback	OUTPUT condition
EXTERNAL FAULT DETECTED	ON	OFF	ON incorrect external connection detected	ON = UG 6911.10 connected to PC OFF = otherwise	Only the number of the INPUT with the incorrect connection flashes				

Dynamic Screen

CONTROL UNIT UG 6911.12/080

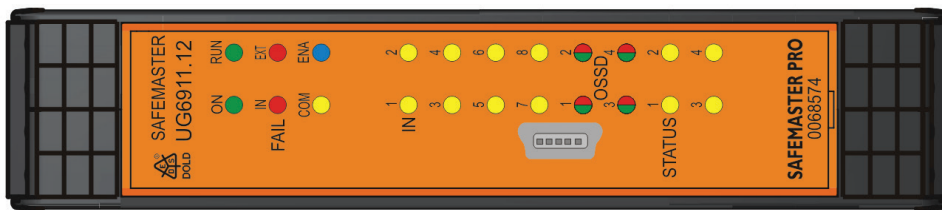

UG 6911.12/080

MEANING	LED															
	RUN	IN FAIL	EXT FAIL	COM	ENA	IN1÷8	OSSD1÷4	STATUS1÷4	GREEN	RED	RED	ORANGE	BLUE	YELLOW	RED / GREEN / YELLOW	YELLOW
	GREEN	RED	RED	ORANGE	BLUE	YELLOW	RED / GREEN / YELLOW	YELLOW	RED	RED	ORANGE	BLUE	YELLOW	RED / GREEN / YELLOW	YELLOW	
Power on - initial TEST	ON	ON	ON	ON	ON	ON	ON	ON	ON	ON	ON	ON	ON	ON	ON	ON
OA 6911 recognized	OFF	OFF	OFF	ON (max 1s)	ON (max. 1s)	OFF	RED	OFF	OFF	OFF	RED	OFF	OFF	RED	OFF	OFF
Writing / Loading diagram to / from OA 6911 card	OFF	OFF	OFF	Flashing 5 times	Flashing 5 times	OFF	RED	OFF	OFF	OFF	RED	OFF	OFF	RED	OFF	OFF
SAFEMASTER PRO error: Internal configuration not present	OFF	OFF	OFF	Slow Flashing	OFF	OFF	RED	OFF	OFF	OFF	RED	OFF	OFF	RED	OFF	OFF
SAFEMASTER PRO error: Slave module or node number not correct (ref. System composition)	OFF	OFF	OFF	Fast Flashing	OFF	OFF	RED	OFF	OFF	OFF	RED	OFF	OFF	RED	OFF	OFF
SAFEMASTER PRO error: Slave module missing or not ready (ref. System composition)	Slow Flashing	OFF	OFF	Fast Flashing	OFF	OFF	RED	OFF	OFF	OFF	RED	OFF	OFF	RED	OFF	OFF
AFEMASTER PRO DESIGNER connected, control unit UG 6911.12/080 stopped	OFF	OFF	OFF	ON	OFF	OFF	RED	OFF	OFF	OFF	RED	OFF	OFF	RED	OFF	OFF

Opening Screen

MEANING	LED															
	RUN	IN FAIL	EXT FAIL	COM	ENA	IN1÷8	OSSD1÷4	STATUS1÷2	GREEN	RED	ORANGE	BLUE	YELLOW	RED / GREEN / YELLOW	YELLOW	
	GREEN	RED	RED	ORANGE	BLUE	YELLOW	RED / GREEN / YELLOW	YELLOW	RED	RED	ORANGE	BLUE	YELLOW	RED / GREEN / YELLOW	YELLOW	
NORMAL OPERATION	ON	OFF	OFF	ON = UG 6911.12/080 connected to PC OFF = otherwise	ON	INPUT condition	RED with output OFF GREEN with output ON YELLOW waiting for tRESTART	OFF	OFF	OFF	RED	ON	OFF	RED	OFF	OUTPUT condition
EXTERNAL FAULT DETECTED	ON	OFF	ON	ON = UG 6911.12/080 connected to PC OFF = otherwise	ON	Only the number of the INPUT with the incorrect connection flashes	YELLOW flashing with inconsistent Feedback (if required)	OFF	OFF	OFF	RED	ON	OFF	RED	OFF	OUTPUT condition

Dynamic Screen

INPUT / OUTPUT MODULE UG 6916.10

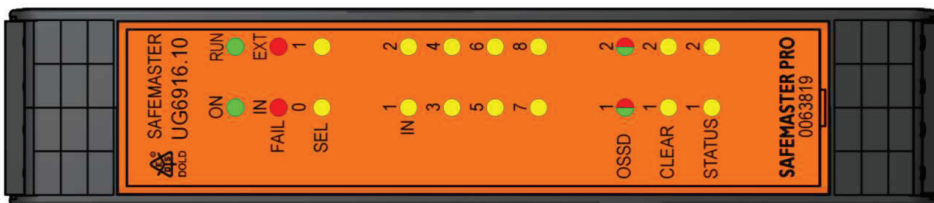

UG 6916.10

MEANING	LED							
	RUN	IN FAIL	EXT FAIL	SEL	IN1÷8	OSSD1÷2	CLEAR1÷2	STATUS1÷2
	GREEN	RED	RED	ORANGE	YELLOW	RED / GREEN	YELLOW	YELLOW
Power on - initial TEST	ON	ON	ON	ON	ON	RED	ON	ON

Opening Screen

MEANING	LED							
	RUN	IN FAIL	EXT FAIL	IN1÷8	SEL	OSSD1÷2	CLEAR1÷2	STATUS1÷2
	GREEN	RED	RED	YELLOW	ORANGE	RED / GREEN	YELLOW	YELLOW
NORMAL OPERATION	if the unit is waiting for the first communication from the control unit FLASHING if no INPUT or OUTPUT requested by the configuration ON if INPUT or OUTPUT requested by the configuration	OFF	OFF	INPUT condition	Shows the signals on terminals NODE_SEL0/1	RED with output OFF	ON waiting for RESTART	OUTPUT condition
		ON incorrect external connection detected	ON incorrect connection detected	Only the number of the INPUT with the incorrect connection flashes		GREEN with output ON	Flashing NO Feedback	OUTPUT condition

Dynamic Screen

INPUT / OUTPUT MODULE UG 6916.12/080

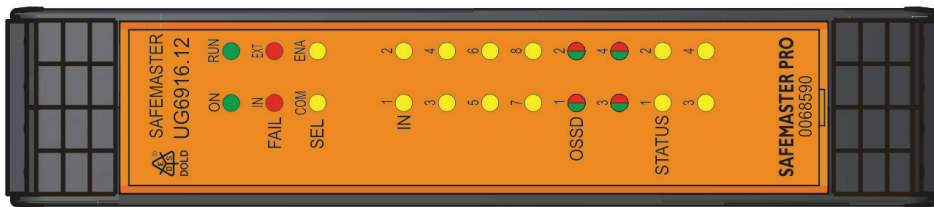

MEANING	LED							
	RUN	IN FAIL	EXT FAIL	SEL	IN1÷8	OSSD1÷4	STATUS1÷4	
	GREEN	RED	RED	ORANGE	YELLOW	RED / GREEN / YELLOW	YELLOW	
Power on - initial TEST	ON	ON	ON	ON	ON	RED	ON	

Opening Screen

MEANING	LED							
	RUN	IN FAIL	EXT FAIL	IN1÷8	SEL	OSSD1÷4	STATUS1÷2	
	GREEN	RED	RED	YELLOW	ORANGE	RED / GREEN	YELLOW	
NORMAL OPERATION	OFF	OFF	OFF	INPUT condition	Shows the signals at terminals NODE_SEL0/1	RED at Ausgang OFF GREEN at Ausgang ON YELLOW in Erwartung auf RESTART YELLOW Flashing NO Feedback	OUTPUT condition	
	if the unit is waiting for the first communication from the control unit FLASHING if no INPUT or OUTPUT requested by the configuration ON if INPUT or OUTPUT requested by the configuration	ON	ON	Es blinkt nur die Nummer des INPUTS mit dem falschen Anschluss				

Dynamic Screen

UG 6916.12/080

INPUT MODULE UG 6916.13.08, UG 6913.12 AND UG 6913.16

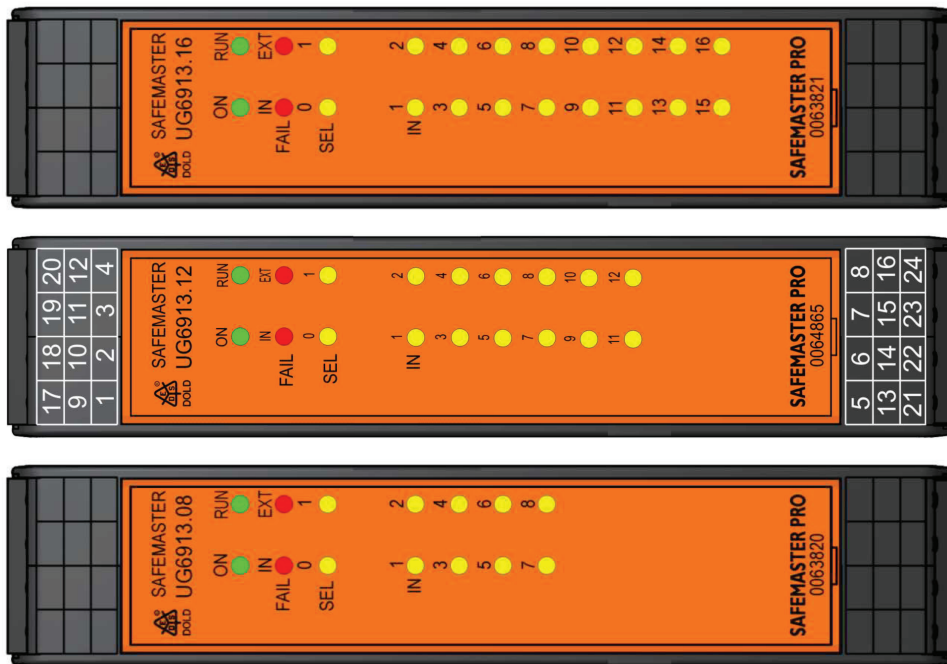

UG 6913.08

UG 6913.12

UG 6913.16

MEANING	LED					
	RUN	IN FAIL	EXT FAIL	SEL	IN1÷16	
	GREEN	RED	RED	ORANGE	YELLOW	
Power on - initial TEST	ON	ON	ON	ON	ON	ON

Opening Screen

MEANING	LED					
	RUN	IN FAIL	EXT FAIL	SEL	IN1÷16	
	GREEN	RED	RED	ORANGE	YELLOW	
NORMAL OPERATION	OFF	OFF	OFF	OFF	OFF	INPUT condition
	if the unit is waiting for the first communication from the control unit					
NORMAL OPERATION	FLASHING	OFF	ON	ON	ON	Shows the signals at terminals NODE_SEL0/1
	if no INPUT or OUTPUT requested by the configuration					
NORMAL OPERATION	ON	ON	ON	ON	ON	Only the number of the INPUT with the incorrect connection flashes
	if INPUT or OUTPUT requested by the configuration					

Dynamic Screen

OUTPUT MODULE OSSD UG 6912.02 AND UG 6912.04

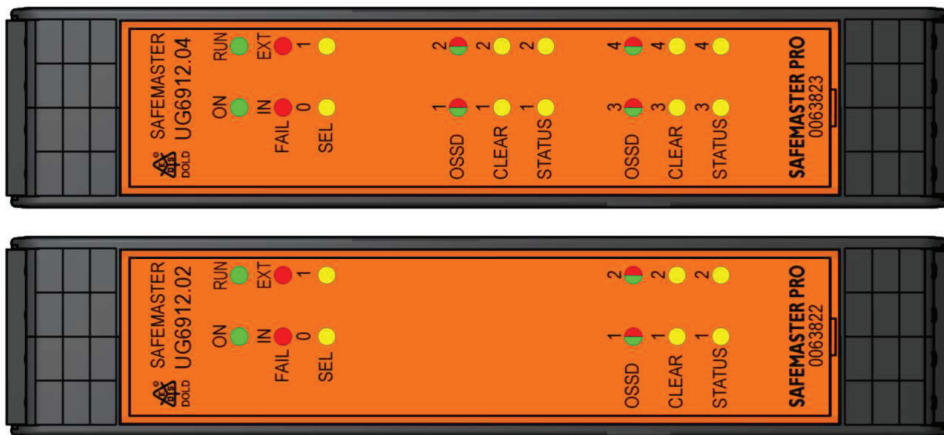

UG 6912.02

UG 6912.04

MEANING	LED							
	RUN	IN FAIL	EXT FAIL	SEL	OSSD1÷4	CLEAR1÷4	STATUS1÷4	
	GREEN	RED	RED	ORANGE	RED / GREEN	YELLOW	YELLOW	
Power on - initial TEST	ON	ON	ON	ON	RED	ON	ON	ON

Opening Screen

MEANING	LED							
	RUN	IN FAIL	EXT FAIL	SEL	OSSD1÷4	CLEAR1÷4	STATUS1÷4	
	GREEN	RED	RED	ORANGE	RED / GREEN	YELLOW	YELLOW	
NORMAL OPERATION	OFF	OFF	OFF	Shows the signals at terminals NODE_ SEL0/1	RED with output OFF	ON waiting for RESTART	OUTPUT condition	
	if the unit is waiting for the first communication from the control unit FLASHING if no INPUT or OUTPUT requested by the configuration ON if INPUT or OUTPUT requested by the configuration	Op. OK	Op. OK		GREEN with output ON	Flashing NO Feedback		

Dynamic Screen

OUTPUT MODULE OSSD UG 6912.04/100

MEANING	LED							
	RUN	IN FAIL	EXT FAIL	SEL	OSSD1÷4	CLEAR1÷4	STATUS1÷8	
Power on - initial TEST	GREEN	RED	RED	ORANGE	RED / GREEN	YELLOW	YELLOW	
	ON	ON	ON	ON	RED	ON	ON	

Opening Screen

MEANING	LED							
	RUN	IN FAIL	EXT FAIL	SEL	OSSD1÷4	CLEAR1÷4	STATUS1÷8	
NORMAL OPERATION	GREEN	RED	RED	ORANGE	RED / GREEN	YELLOW	YELLOW	
	OFF if the unit is waiting for the first communication from the control unit	OFF Op. OK	OFF Op. OK	Shows the signals at terminals NODE_SEL0/1	RED with output OFF GREEN with output ON	ON waiting for RESTART Flashing NO Feedback	ON The associated SYSTEM STATUS output is active OFF The associated SYSTEM STATUS output is NOT active	

Dynamic Screen

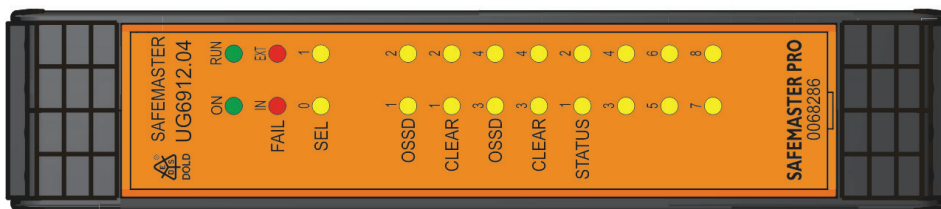

UG 6912.04/100

OUTPUT MODULE RELAY UG 6912.14 AND UG 6912.28

MEANING	LED
	OSSD1
	GREEN
NORMAL OPERATION	GREEN with output activated

UG 6912.14 Dynamic Screen

MEANING	LED
	OSSD1
	OSSD2
NORMAL OPERATION	GREEN with output activated

UG 6912.28 Dynamic Screen

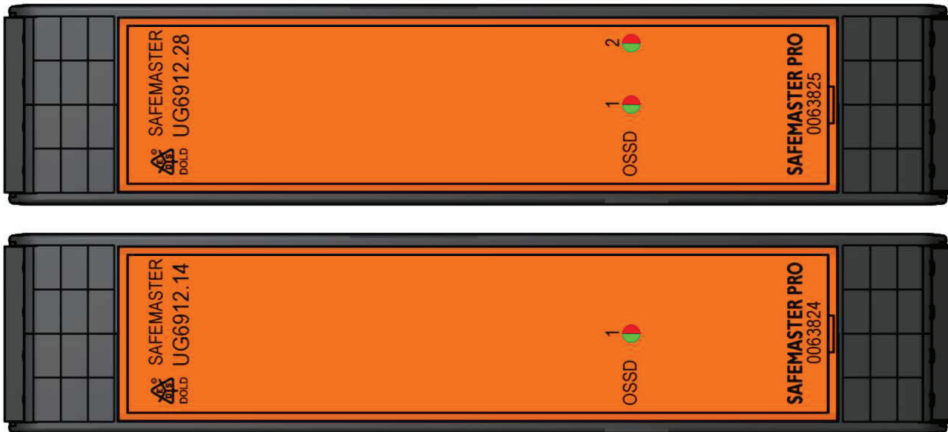

UG 6912.14

UG 6912.28

OUTPUT MODULE RELAY UG 6914.04/000 AND UG 6914.04/008

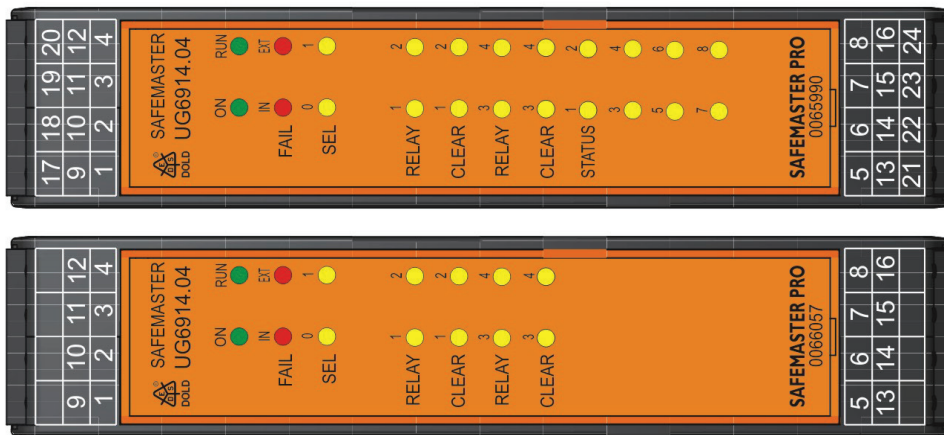

MEANING	LED							
	RUN	IN FAIL	EXT FAIL	SEL 0÷1	RELAY1÷4	CLEAR1÷4	STATUS1÷8 1)	
	GREEN	RED	RED	ORANGE	RED/GREEN	YELLOW	YELLOW	
Power on - initial TEST	ON	ON	ON	ON	RED	ON	ON	ON

Opening Screen

MEANING	LED							
	RUN	IN FAIL	EXT FAIL	SEL 0÷1	RELAY1÷4	CLEAR1÷4	STATUS1÷8 1)	
	GREEN	RED	RED	ORANGE	RED / GREEN	YELLOW	YELLOW	
NORMAL OPERATION	OFF	OFF	OFF	Shows the signals at terminals at NODE_SEL0/1	RED with output OFF	ON	Waiting for RESTART	Condition OUT-STATUS
	FLASHING	Op. OK	Op. OK		GREEN with output ON	FLASHING	External contactors feedback error	
	ON	Op. OK	Op. OK					

Dynamic Screen

UG 6914.04/000 UG 6914.04/008 1)

OUTPUT MODULE SIGNAL UG 6915/008 AND UG 6915/016

MEANING	LED			
	RUN	IN FAIL	EXT FAIL	STATUS1÷16
Power on - initial TEST	GREEN	RED	RED	YELLOW
	ON	ON	ON	ON

Opening Screen

MEANING	LED			
	RUN	IN FAIL	EXT FAIL	STATUS1÷16
NORMAL OPERATION	GREEN	RED	RED	YELLOW
	<p>OFF</p> <p>if the unit is waiting for the first communication from the control unit</p> <p>FLASHING</p> <p>if no INPUT or OUTPUT requested by the configuration</p> <p>ON</p> <p>if INPUT or OUTPUT requested by the configuration</p>	<p>OFF</p> <p>Op. OK</p>	<p>OFF</p> <p>Op. OK</p>	<p>Shows the signals at terminals NODE_SEL0/1</p> <p>Condition OUTPUT</p>

Dynamic Screen

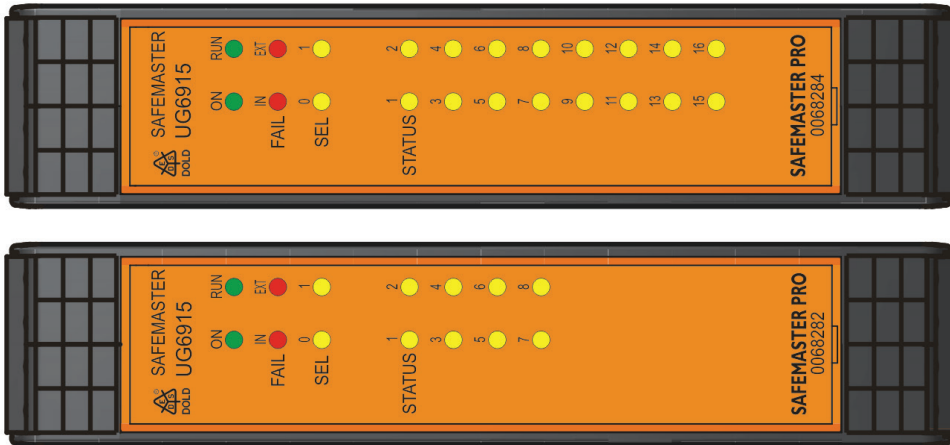

UG 6915/008

UG 6915/016

SPEED MONITORING MODULE UG 6917/002, UG 6917/X02 AND UG 6917/XX2

MEANING	LED							
	IN FAIL	EXT FAIL	SELO÷1	ENC *)	PROX	SH		
	RED	RED	ORANGE	YELLOW	YELLOW	YELLOW	YELLOW	YELLOW
Power on - initial TEST	ON	ON	ON	ON	ON	ON	ON	ON

Opening Screen

MEANING	LED							
	IN FAIL	EXT FAIL	SEL	ENC *)	PROX	SH		
	RED	RED	ORANGE	YELLOW	YELLOW	YELLOW	YELLOW	YELLOW
NORMAL OPERATION	OFF	OFF	Shows the signals at terminals NODE_SEL0/1	ON:	ON:	OFF	Axis in normal speed range	
	FLASHING	OFF		Encoder connected and operative	Proximity connected and operative	Flashing:	Axis in overspeed	
	ON	OK		Flashing: Encoder requested by the configuration but not connected		ON	Axis in stand still	

Dynamic Screen

*) LED ENC LED ENC not present on UG 6917/002

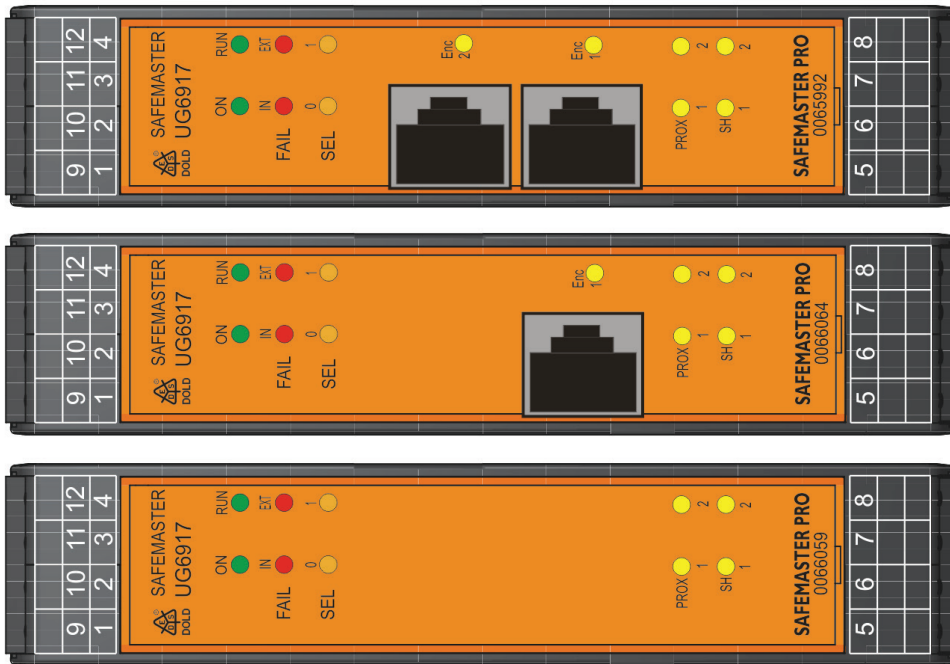

UG 6917/002

UG 6917/x02

UG 6917/xx2

BUSEXTENDER MODULE UG 6918

MEANING	LED			
	ON	RUN	IN FAIL	EXT FAIL
	GREEN	GREEN	RED	RED
Power on - initial TEST	ON	ON	ON	ON
NORMAL OPERATION	ON	OFF > Flashing > ON	OFF Operation OK	OFF Operation OK

Dynamic Screen



UG 6918

TROUBLESHOOTING

CONTROL UNIT UG 6911.10

MEANING	LED												REMEDY
	RUN GREEN	IN FAIL RED	EXT FAIL RED	COM ORANGE	ENA BLUE	IN1-8 YELLOW	OSSD1-2 RED / GREEN	CLEAR1-2 YELLOW	STATUS1-4 YELLOW				
Internal fault	OFF	Flashing 2 or 3 times	OFF	OFF	OFF	OFF	RED	OFF	OFF	OFF	OFF	OFF	<ul style="list-style-type: none"> Return the unit to DOLD to be repaired
OSSD output error	OFF	Flashing 4 times	OFF	OFF	OFF	OFF	Flashing 4 times (only the LED corresponding to the output in FAIL mode)	OFF	OFF	OFF	OFF	OFF	<ul style="list-style-type: none"> Check the OSSD1/2 connections If the problem persists return the UG 6911.10 to DOLD to be repaired
Error in communication with expansion units	OFF	Flashing 5 times	OFF	OFF	OFF	OFF	OFF	OFF	OFF	OFF	OFF	OFF	<ul style="list-style-type: none"> Restart the system If the problem persists return the UG 6911.10 to DOLD to be repaired
Expansion unit error	OFF	ON	OFF	OFF	OFF	OFF	OFF	OFF	OFF	OFF	OFF	OFF	<ul style="list-style-type: none"> Restart the system Check which unit is in FAIL mode
Memory chip OA 6911 error	OFF	Flashing 6 times	OFF	Flashing 6 times	OFF	OFF	OFF	OFF	OFF	OFF	OFF	OFF	<ul style="list-style-type: none"> Replace the OA 6911
In-Rail-Bus error	Flashing 12 times	OFF	OFF	Flashing 12 times	OFF	OFF	RED	OFF	OFF	OFF	OFF	OFF	<ul style="list-style-type: none"> Contact from Control unit or extension unit to IN-RAIL-BUS not correct (ref. System composition)

Troubleshooting

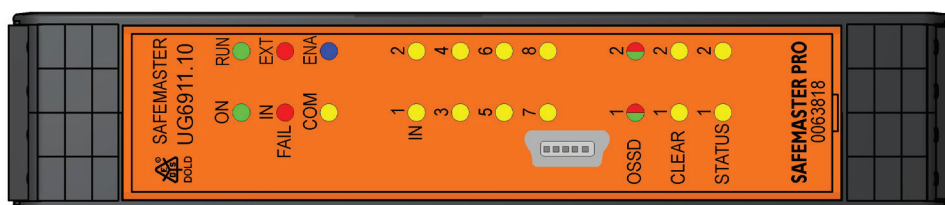

UG 6911.10

CONTROL UNIT UG 6911.12/080

MEANING	LED										REMEDY
	RUN GREEN	IN FAIL RED	EXT FAIL RED	COM ORANGE	ENA BLUE	IN1÷8 YELLOW	OSSD1÷4 RED / GREEN	STATUS1÷4 YELLOW			
Internal fault	OFF	Flashing 2 or 3 times	OFF	OFF	OFF	OFF	RED	OFF	OFF	OFF	<ul style="list-style-type: none"> Return the unit to DOLD to be repaired
OSSD output error	OFF	Flashing 4 times	OFF	OFF	OFF	Flashing 4 times (only the LED corresponding to the output in FAIL mode)	OFF	OFF	OFF	OFF	<ul style="list-style-type: none"> Check the OSSD1/2 connections If the problem persists return the UG 6911.12/080 to DOLD to be repaired
Error in communication with expansion units	OFF	Flashing 5 times	OFF	OFF	OFF	OFF	OFF	OFF	OFF	OFF	<ul style="list-style-type: none"> Restart the system If the problem persists return the UG 6911.12/080 to DOLD to be repaired
Expansion unit error	OFF	ON	OFF	OFF	OFF	OFF	OFF	OFF	OFF	OFF	<ul style="list-style-type: none"> Restart the system Check which unit is in FAIL mode
Memory chip OA 6911 error	OFF	Flashing 6 times	OFF	Flashing 6 times	OFF	OFF	OFF	OFF	OFF	OFF	<ul style="list-style-type: none"> Replace the OA 6911
Overload on OSSD or load connected to 24 V DC	ON	OFF	ON	OFF	ON	INPUT-Status	Flashes RED (only LED corresponding to the relative output)	OUTPUT-Status	INPUT-Status	OUTPUT-Status	<ul style="list-style-type: none"> Verify OSSD connections
Short circuit or overload detected on status output	ON	OFF	ON	OFF	ON	INPUT-Status	OUTPUT-Status	Flashing	INPUT-Status	OUTPUT-Status	<ul style="list-style-type: none"> Verify output status connections

Troubleshooting

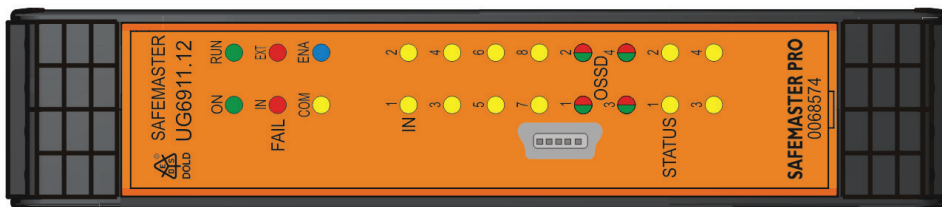

UG 6911.12/080

INPUT / OUTPUT MODULE UG 6916.10

MEANING	LED										REMEDY	
	RUN GREEN	IN FAIL RED	EXT FAIL RED	SEL ORANGE	IN1÷8 YELLOW	OSSD1÷2 RED / GREEN	CLEAR1÷2 YELLOW	STATUS1÷4 YELLOW				
Internal fault	OFF	Flashing 2 or 3 times	OFF		OFF	RED	OFF	OFF			<ul style="list-style-type: none"> Return the unit to DOLD to be repaired 	
Compatibility error	OFF	Flashing 5 times	OFF		Flashing 5 times	Flashing 5 times	Flashing 5 times	Flashing 5 times			<ul style="list-style-type: none"> Firmware version not compatible with control unit, return to DOLD for FW upgrade 	
OSSD output error	OFF	Flashing 4 times	OFF	Shows the physical address of the unit	OFF	Flashing 4 times (only the LED corresponding to the output in FAIL mode)	OFF	OFF			<ul style="list-style-type: none"> Check the OSSD1/2 connections If the problem persists return the UG 6916.10 to DOLD to be repaired 	
Error in communication with control unit	OFF	Flashing 5 times	OFF		OFF	OFF	OFF	OFF	OFF			<ul style="list-style-type: none"> Restart the system If the problem persists return the UG 6916.10 to DOLD to be repaired
Error on other unit	OFF	ON	OFF		OFF	OFF	OFF	OFF	OFF			<ul style="list-style-type: none"> Restart the system Check which unit is in FAIL mode
Same type of expansion unit with same address detected	OFF	Flashing 5 times	Flashing 5 times		OFF	OFF	OFF	OFF			<ul style="list-style-type: none"> Change the unit's address (see NODE SEL) 	
Error on node detection circuit	OFF	Flashing 3 times	OFF	Flashing 3 times	OFF	OFF	OFF	OFF			<ul style="list-style-type: none"> Return the unit to DOLD to be repaired 	

Troubleshooting

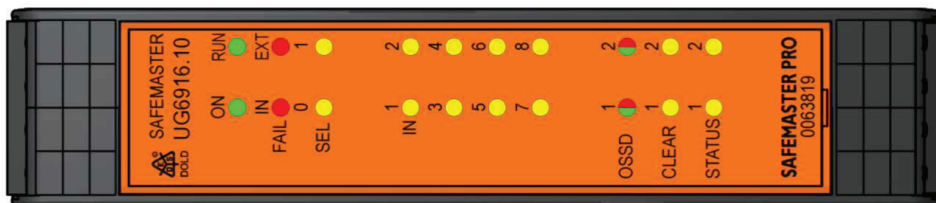

UG 6916.10

INPUT / OUTPUT MODULE UG 6916.12/080

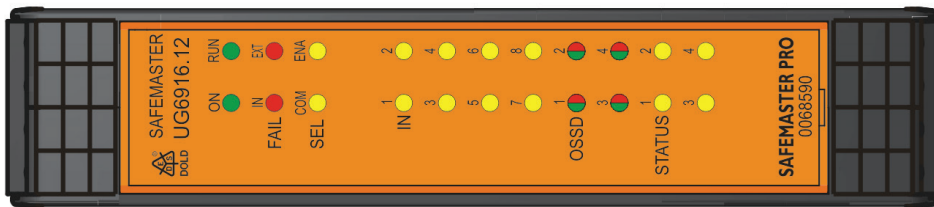

MEANING	LED								REMEDY
	RUN	IN FAIL	EXT FAIL	SEL	IN1-8	OSSID1-4	STATUS1-4		
	GREEN	RED	RED	ORANGE	YEL-LOW	RED / GREEN	YELLOW		
Internal fault	OFF	Flashing 2 or 3 times	OFF		OFF	RED	OFF	OFF	<ul style="list-style-type: none"> Return the unit to DOLD to be repaired
Compatibility error	OFF	Flashing 5 times	OFF		Flashing 5 times	Flashing 5 times	Flashing 5 times	Flashing 5 times	<ul style="list-style-type: none"> Firmware version not compatible with control unit, return to DOLD for FW upgrade
OSSD output error	OFF	Flashing 4 times	OFF		OFF	Flashing 4 times (only the LED corresponding to the output in FAIL mode)	OFF	OFF	<ul style="list-style-type: none"> Check the OSSD1/2 connections If the problem persists return the UG 6916.12/080 to DOLD to be repaired
Error in communication with control unit	OFF	Flashing 5 times	OFF		OFF	OFF	OFF	OFF	<ul style="list-style-type: none"> Restart the system If the problem persists return the UG 6916.12/080 to DOLD to be repaired
Error on other unit	OFF	ON	OFF		OFF	OFF	OFF	OFF	<ul style="list-style-type: none"> Restart the system Check which unit is in FAIL mode
Same type of expansion unit with same address detected	OFF	Flashing 5 times	Flashing 5 times		OFF	Flashes RED (only the LED corresponding to the output in FAIL mode)	INTPUT-Status	OUTPUT-Status	<ul style="list-style-type: none"> Change the unit's address (see NODE SEL)
Overload on OSSD or load connected to 24 V DC	ON	OFF	ON		OFF	OFF	INTPUT-Status	OUTPUT-Status	<ul style="list-style-type: none"> Verify OSSD connections
Short circuit or overload detected on status output	ON	OFF	ON		OFF	OFF	INTPUT-Status	Flashing	<ul style="list-style-type: none"> Verify output status connections

Shows the physical address of the unit

Troubleshooting

UG 6916.12/080

INPUT MODULE UG 6916.13.08, UG 6913.12 AND UG 6913.16

MEANING	LED						REMEDY
	RUN	IN FAIL	EXT FAIL	SEL	INT ÷8	YELLOW	
	GREEN	RED	RED	ORANGE	OFF		
Internal fault	OFF	Flashing 2 or 3 times	OFF		OFF	OFF	<ul style="list-style-type: none"> Return the unit to DOLD to be repaired
Compatibility error	OFF	Flashing 5 times	OFF		Flashing 5 times		<ul style="list-style-type: none"> Firmware version not compatible with control unit, return to DOLD for FW upgrade
Error in communication with control unit	OFF	Flashing 5 times	OFF	Shows the physical address of the unit	OFF	OFF	<ul style="list-style-type: none"> Restart the system If the problem persists return the UG 6913 to DOLD to be repaired
Error on other unit	OFF	ON	OFF		OFF	OFF	<ul style="list-style-type: none"> Restart the system Check which unit is in FAIL mode
Same type of expansion unit with same address detected	OFF	Flashing 5 times	Flashing 5 times		Flashing 5 times	OFF	<ul style="list-style-type: none"> Change the unit's address (see NODE SEL)
Error on node detection circuit	OFF	Flashing 3 times	OFF	Flashing 3 times	OFF	OFF	<ul style="list-style-type: none"> Return the unit to DOLD to be repaired

Troubleshooting

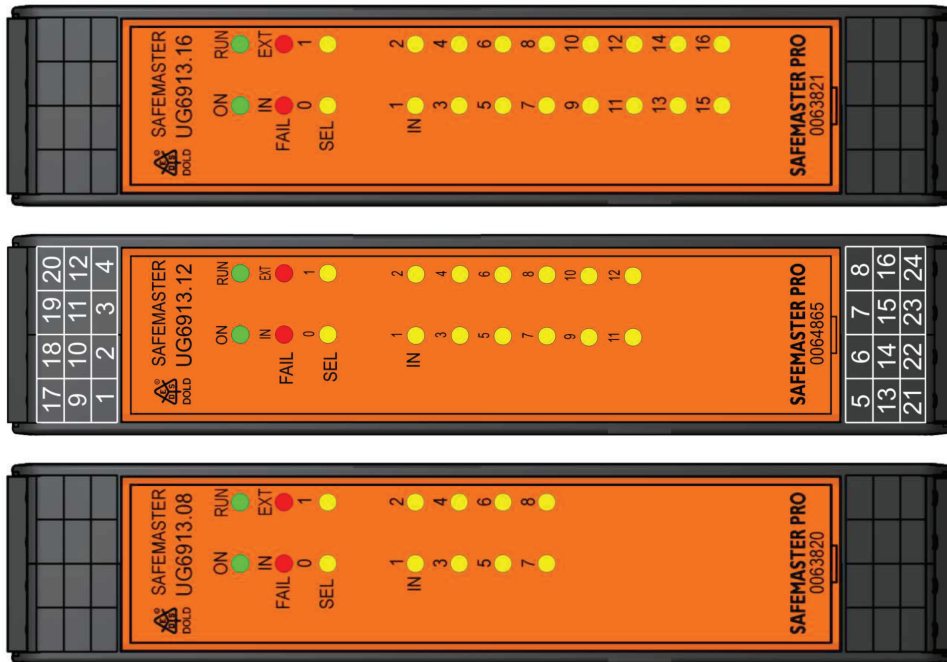

UG 6913.08

UG 6913.12

UG 6913.16

OUTPUT MODULE OSSD UG 6912.02 AND UG 6912.04

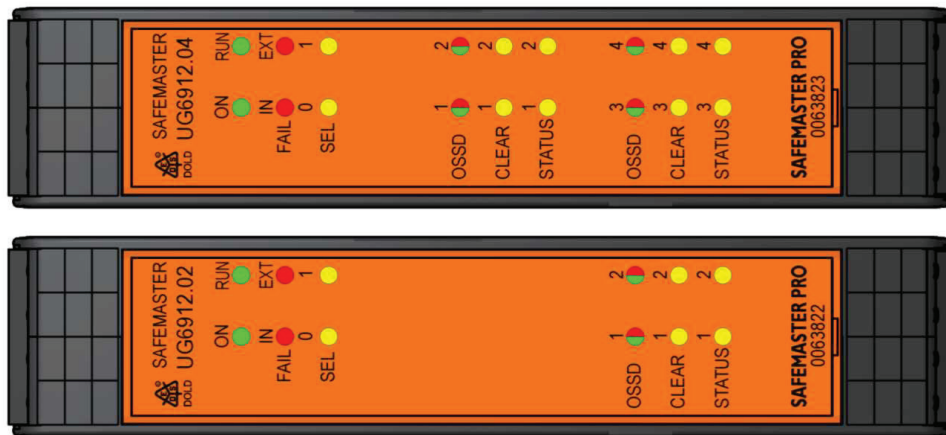

UG 6912.02

UG 6912.04

MEANING	LED										REMEDY	
	RUN GREEN	IN FAIL RED	EXT FAIL RED	SEL ORANGE	OSSD1÷4 RED/GREEN	CLEAR1÷4 YELLOW	STATUS1÷4 YELLOW					
Internal fault	OFF	Flashing 2 or 3 times	OFF		RED	OFF	OFF	OFF			OFF	<ul style="list-style-type: none"> Return the unit to DOLD to be repaired
Compatibility error	OFF	Flashing 5 times	OFF		Flashing 5 times	Flashing 5 times					Flashing 5 times	<ul style="list-style-type: none"> Firmware version not compatible with control unit, return to DOLD for FW upgrade
OSSD output error	OFF	Flashing 4 times	OFF	Shows the physical address of the unit	Flashing 4 times (only the LED corresponding to the output in FAIL mode)	OFF					OFF	<ul style="list-style-type: none"> Check OSSD1/2 connections If the problem persists return the UG 6912.02 / .04 to DOLD to be repaired
Error in communication with control unit	OFF	Flashing 5 times	OFF		OFF	OFF					OFF	<ul style="list-style-type: none"> Restart the system If the problem persists return the UG 6912.02 / .04 to DOLD to be repaired
Error on other unit	OFF	ON	OFF		OFF	OFF					OFF	<ul style="list-style-type: none"> Restart the system Check which unit is in FAIL mode
Same type of expansion unit with same address detected	OFF	Flashing 5 times	Flashing 5 times		OFF	OFF					OFF	<ul style="list-style-type: none"> Change the unit's address (see NODE SEL)
Power supply missing on OSSD 3,4	ON	OFF	ON		RED flashing	Flashing					OUTPUT condition	<ul style="list-style-type: none"> Connect terminal 13, 14 an to power supply +24 V DC
Status output overload or short circuit	OFF	OFF	ON		OSSD output state	CLEAR condition					Blinkend	<ul style="list-style-type: none"> Check terminals 8, 12, 20, 24
Error on node detection circuit	OFF	Flashing 3 times	OFF	Flashing 3 times	OFF	OFF					OFF	<ul style="list-style-type: none"> Return the unit to DOLD to be repaired

Troubleshooting

OUTPUT MODULE OSSD UG 6912.04/100

MEANING	LED								REMEDY
	RUN	IN FAIL	EXT FAIL	SEL	OSSD1÷4	CLEAR1÷4	STATUS1÷8	YELLOW	
	GREEN	RED	RED	ORANGE	RED / GREEN	YELLOW	YELLOW		
Internal fault	OFF	Flashing 2 or 3 times	OFF		RED	OFF	OFF	OFF	<ul style="list-style-type: none"> Return the unit to DOLD to be repaired
Compatibility error	OFF	Flashing 5 times	OFF		Flashing 5 times	Flashing 5 times	Flashing 5 times	Flashing 5 times	<ul style="list-style-type: none"> Firmware version not compatible with control unit; return to DOLD for FW upgrade
OSSD output error	OFF	Flashing 4 times	OFF		Flashing 4 times (only the LED corresponding to the output in FAIL mode)	OFF	OFF	OFF	<ul style="list-style-type: none"> Check OSSD1/2 connections If the problem persists return the UG 6912.04/100 to DOLD to be repaired
Error in communication with control unit	OFF	Flashing 5 times	OFF	Shows the physical address of the unit	OFF	OFF	OFF	OFF	<ul style="list-style-type: none"> Restart the system If the problem persists return the UG 6912.04/100 to DOLD to be repaired
Error on other unit	OFF	ON	OFF		OFF	OFF	OFF	OFF	OFF
Same type of expansion unit with same address detected	OFF	Flashing 5 times	Flashing 5 times		OFF	OFF	OFF	OFF	<ul style="list-style-type: none"> Change the unit's address (see NODE SEL)
Short circuit or overload detected on status output	ON	OFF	ON		OUTPUT-Status	CLEAR	Flashing	Flashing	<ul style="list-style-type: none"> Verify output status connections
Overload on OSSD or load connected to 24 V DC	ON	OFF	ON		Flashing (only LED corresponding to the relative output)	OFF	OUTPUT-condition	OUTPUT-condition	<ul style="list-style-type: none"> Verify OSSD connections
Power supply missing on OSSD 3,4	ON	OFF	ON		OSSD3/OSSD4 Flashing	OSSD3/OSSD4 Flashing	OUTPUT-condition	OUTPUT-condition	<ul style="list-style-type: none"> Connect terminal 14 to power supply + 24 V DC
Error on node detection circuit	OFF	Flashing 3 times	OFF	Flashing 3 times	OFF	OFF	OFF	OFF	<ul style="list-style-type: none"> Return the unit to DOLD to be repaired

Troubleshooting

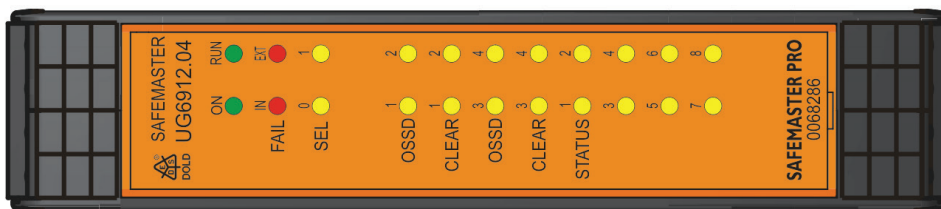

UG 6912.04/100

OUTPUT MODULE RELAY UG 6914.04/000 AND UG 6914.04/008

MEANING	LED								REMEDY
	RUN GREEN	IN FAIL RED	EXT FAIL RED	SEL 0÷1 ORANGE	RELAY1÷4 RED / GREEN	CLEAR1÷4 YELLOW	STATUS1÷8 YELLOW		
	Internal fault	OFF	Flashing 2 or 3 times	OFF		RED	OFF	OFF	
Compatibility error	OFF	Flashing 5 times	OFF		Flashing 5 times	Flashing 5 times	Flashing 5 times	Flashing 5 times	<ul style="list-style-type: none"> Firmware version not compatible with control unit, return to DOLD for FW upgrade
Fehler Relais-Ausgänge	OFF	Flashing 4 times	OFF		Flashing 4 times (only the LED corresponding to the output in FAIL mode)		OFF	OFF	<ul style="list-style-type: none"> Check connections at relays outputs If the problem persists return the UG 6914 to DOLD to be repaired
Error in communication with control unit	OFF	Flashing 5 times	OFF	Shows the physical address of the unit	OFF	OFF	OFF	OFF	<ul style="list-style-type: none"> Restart the system If the problem persists return the UG 6914 to DOLD to be repaired
Error on other unit	OFF	ON	OFF		OFF	OFF	OFF	OFF	<ul style="list-style-type: none"> Restart the system Check which unit is in FAIL mode
Same type of expansion unit with same address detected	OFF	Flashing 5 times	Flashing 5 times		OFF	OFF	OFF	OFF	<ul style="list-style-type: none"> Change the unit's address (see NODE SEL)
Externer Fbk-Fehler an Relais der Category 4	ON	OFF	Flashing 4 times		Flashing 4 times (only the LED corresponding to the output in FAIL mode)		OFF	OFF	<ul style="list-style-type: none"> Check connections at terminal REST_FBK
Short circuit or overload detected	OFF	OFF	ON	OFF	OUTPUT-condition	CLEAR condition	Flashing	Flashing	<ul style="list-style-type: none"> Check connections at Output
Error on node detection circuit	OFF	Flashing 3 times	OFF	Flashing 3 times	OFF	OFF	OFF	OFF	<ul style="list-style-type: none"> Return the unit to DOLD to be repaired

Troubleshooting

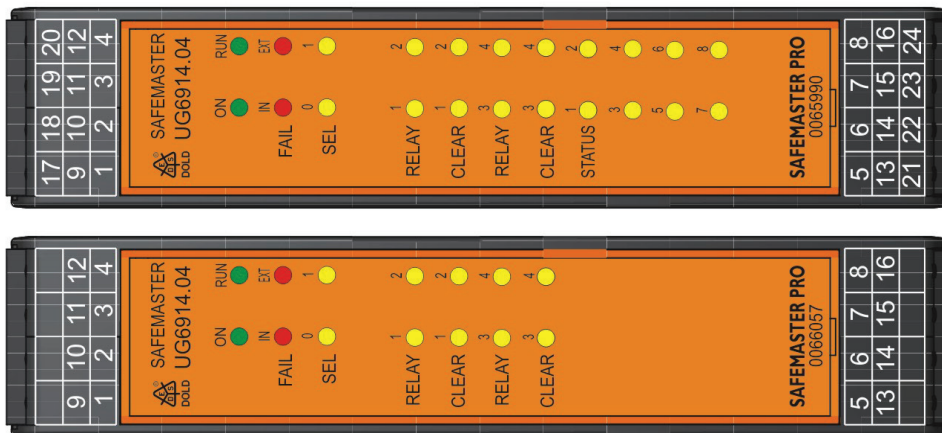

UG 6914.04/000 UG 6914.04/008

OUTPUT MODULE SIGNAL UG 6915/008

MEANING	LED						REMEDY
	RUN	IN FAIL	EXT FAIL	SELO÷1	STATUS1÷8	YELLOW	
	GREEN	RED	RED	ORANGE	YELLOW		
Internal fault	OFF	Flashing 2 or 3 times	OFF	Shows the physical address of the unit	OFF	OFF	<ul style="list-style-type: none"> Return the unit to DOLD to be repaired
Compatibility error	OFF	Flashing 5 times	OFF		Flashing 5 times	Flashing 5 times	<ul style="list-style-type: none"> Firmware version not compatible with control unit, return to DOLD for FW upgrade
Error in communication with control unit	OFF	Flashing 5 times	OFF		Flashing 5 times	OFF	OFF
Error on other unit	OFF	ON	OFF	OFF	OFF	OFF	<ul style="list-style-type: none"> Restart the system Check which unit is in FAIL mode
Same type of expansion unit with same address detected	OFF	Flashing 5 times	Flashing 5 times	OFF	OFF	OFF	<ul style="list-style-type: none"> Change the unit's address (see NODE SEL)
Short circuit or overload detected on status 1÷8	OFF	OFF	ON	OFF	Flashing	Flashing	<ul style="list-style-type: none"> Check connections at terminals 1÷8
Power supply missing on status 1÷8	OFF	OFF	ON	OFF	Flashing alternatively	Flashing alternatively	<ul style="list-style-type: none"> Connect terminal 5 to power supply + 24 V DC
Error on node detection circuit	OFF	Flashing 3 times	OFF	Flashing 3 times	OFF	OFF	<ul style="list-style-type: none"> Internal fault Return the unit to DOLD to be repaired

Troubleshooting

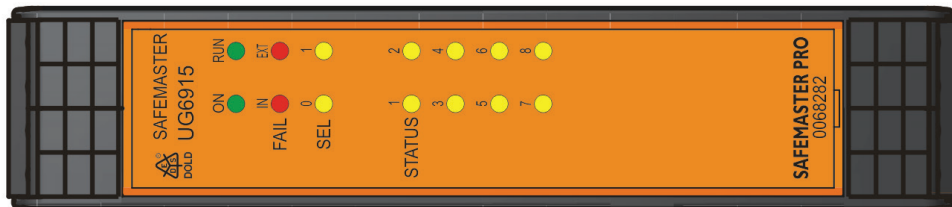

UG 6915/008

OUTPUT MODULE SIGNAL UG 6915/016

MEANING	LED						STATUS1÷8 YELLOW	REMEDY
	RUN	IN FAIL	EXT FAIL	SEL0÷1	STATUS1÷8 YELLOW	STATUS1÷8 YELLOW		
	GREEN	RED	RED	ORANGE	YELLOW	YELLOW		
Internal fault	OFF	Flashing 2 or 3 times	OFF	Shows the physical address of the unit	OFF	OFF	<ul style="list-style-type: none"> Return the unit to DOLD to be repaired 	
Compatibility error	OFF	Flashing 5 times	OFF		Flashing 5 times	Flashing 5 times	<ul style="list-style-type: none"> Firmware version not compatible with control unit, return to DOLD for FW upgrade 	
Error in communication with control unit	OFF	Flashing 5 times	OFF		OFF	OFF	<ul style="list-style-type: none"> Restart the system If the problem persists return the UG 6915 to DOLD to be repaired 	
Error on other unit	OFF	ON	OFF		OFF	OFF	<ul style="list-style-type: none"> Restart the system Check which unit is in FAIL mode 	
Same type of expansion unit with same address detected	OFF	Flashing 5 times	Flashing 5 times	OFF	OFF	OFF	<ul style="list-style-type: none"> Change the unit's address (see NODE SEL) 	
Short circuit or overload detected on status 1÷8	OFF	OFF	ON	OFF	Flashing	OFF	<ul style="list-style-type: none"> Verify output status 1÷8 connections 	
Short circuit or overload detected on status 9÷16	OFF	OFF	ON	OFF	OFF	Flashing	<ul style="list-style-type: none"> Verify output status 9÷16 connections 	
Power supply missing on status 1÷8	OFF	OFF	ON	OFF	Flashing alternatively	OFF	<ul style="list-style-type: none"> Connect terminal 5 to power supply + 24 V DC 	
Power supply missing on status 9÷16	OFF	OFF	ON	OFF	OFF	Flashing alternatively	<ul style="list-style-type: none"> Connect terminal 6 to power supply + 24 V DC 	
Error on node detection circuit	OFF	Flashing 3 times	OFF	Flashing 3 times	OFF	OFF	<ul style="list-style-type: none"> Internal fault. Return the unit to DOLD to be repaired 	

Troubleshooting

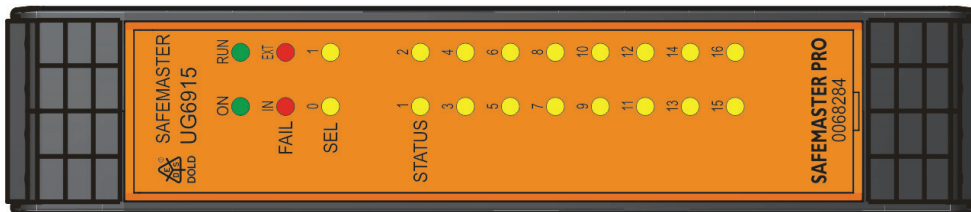

UG 6915/016

SPEED MONITORING MODULE UG 6917/002, UG 6917/X02 AND UG 6917/XX2

MEANING	LED								REMEDY	
	RUN	IN FAIL	EXT FAIL	SEL 0-1	ENC *)	PROX	SH			
	GREEN	RED	RED	ORANGE	YELLOW	YELLOW	YELLOW			
Internal fault	OFF	Flashing 2 or 3 times	OFF		OFF	OFF	OFF	OFF	<ul style="list-style-type: none"> Return the unit to DOLD to be repaired 	
Compatibility error	OFF	Flashing 5 times	OFF		Flashing 5 times	Flashing 5 times	Flashing 5 times	Flashing 5 times	<ul style="list-style-type: none"> Firmware version not compatible with control unit, return to DOLD for FW upgrade 	
<ul style="list-style-type: none"> Encoder not connected but requested from the configuration Encoder EXTERNAL error 	OFF	OFF	Continuous flashing	Shows the physical address of the unit	Continuous flashing	OFF	OFF	OFF	<ul style="list-style-type: none"> Verify encoder connection Verify power supply Verify input frequency (in range) 	
Encoder INTERNAL error	OFF	Flashing 3 times	OFF		Flashing 3 times	OFF	OFF	OFF	OFF	<ul style="list-style-type: none"> Change the encoder Return the unit to DOLD to be repaired
<ul style="list-style-type: none"> Proximity not connected but requested from the configuration Proximity EXTERNAL error 	OFF	OFF	Flashing 3 times		Flashing 3 times	OFF	Flashing 3 times	Flashing 3 times	Flashing 3 times	<ul style="list-style-type: none"> Verify proximity connection and power supply Verify input frequency (in range)
Proximity INTERNAL error	OFF	Flashing 3 times	OFF		OFF	OFF	OFF	OFF	<ul style="list-style-type: none"> Change the proximity Return the unit to DOLD to be repaired 	
Anderes Erweiterungsmodul desselben Typs mit derselben Adresse erfasst	OFF	Flashing 5 times	Flashing 5 times		OFF	OFF	OFF	OFF	<ul style="list-style-type: none"> Change the unit's address (see NODE SEL) 	
Error on node detection circuit	OFF	Flashing 3 times	OFF	Flashing 3 times	OFF	OFF	OFF	OFF	<ul style="list-style-type: none"> Return the unit to DOLD to be repaired 	

Troubleshooting

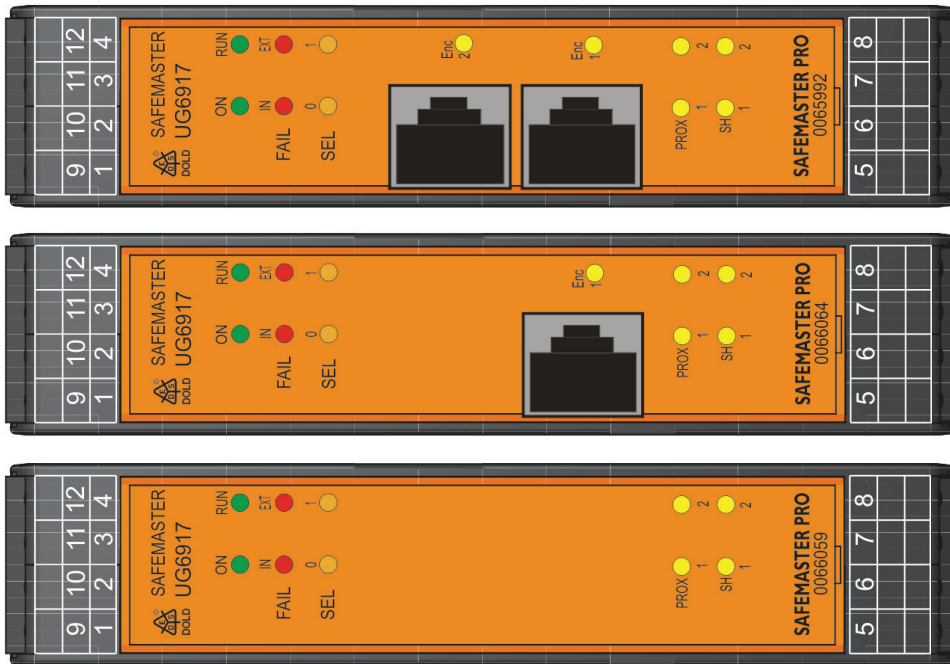

UG 6917/002 UG 6917/x02 UG 6917/xx2

*) LED ENC LED ENC not present on UG 6917/002

BUSEXTENDER MODULE UG 6918

MEANING	LED				REMEDY
	ON GREEN	RUN GREEN	IN FAIL RED	EXT FAIL RED	
Internal fault detected (Not recoverable. Restart the system)	ON	OFF Flashing	OFF	Follows UG 6911.10 error codification	
Fault detected on terminal connection (recoverable)	ON	OFF	OFF	OFF	

Troubleshooting



UG 6918

SOFTWARE

SAFEMASTER PRO DESIGNER

The "**SAFEMASTER PRO DESIGNER**" software can be used to configure a logic diagram of the connections between the SAFEMASTER PRO (control unit + expansions) and the components of the system being developed. The SAFEMASTER PRO will thus monitor and control the connected safety components.

The SAFEMASTER PRO DESIGNER uses a versatile graphic interface to establish the connections between the various components, as described below:

INSTALLING THE SOFTWARE

PC HARDWARE requirements

- RAM-Speicher: > 2 GB
- Hard disk: > 500 Mbyte of free space
- USB-connector: 2.0 or higher
- CD-ROM-drive

PC SOFTWARE requirements

- Windows 7 with Service Pack 1 installed (or higher OS)



Microsoft Framework 4.8 must be installed on the PC)

How to install SAFEMASTER PRO DESIGNER

- Insert the installation CD;
- Wait for the auto-run installer to request the software setup program;

Alternatively search and open the file SetupDesigner.exe

When the installation procedure is complete a window is displayed asking you to close the setup program.

FUNDAMENTALS

SYMBOL

Once the SAFEMASTER PRO DESIGNER has been correctly installed it creates an icon on the desktop.

To launch the program: Double-click on this icon. →



OPENING SCREEN

The opening screen shown below is displayed:

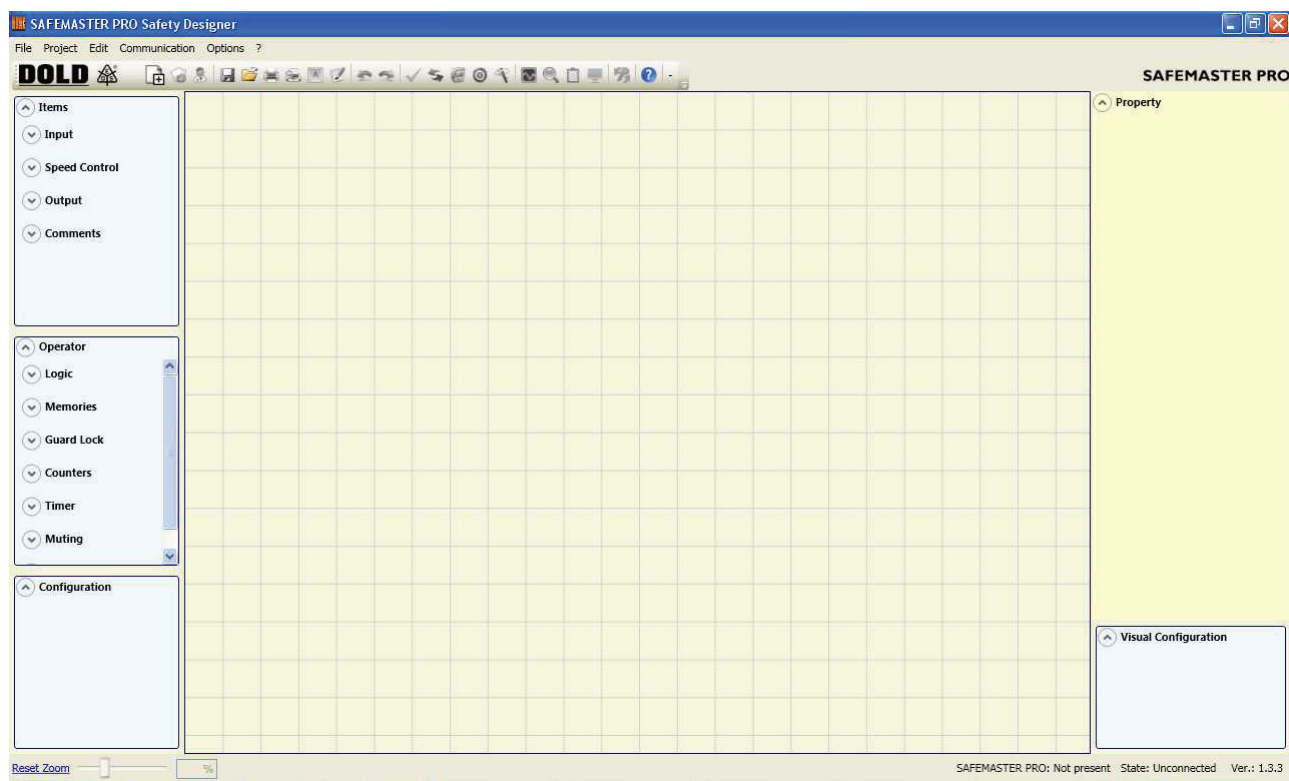

You are now ready to create your project.



Warning

The PFH_d , $MTTF_d$ and DC_{avg} values which are shown in "Project report - SAFEMASTER PRO - Safety information" refer exclusively to the internal operation of SAFEMASTER PRO.

For the calculation of the total PFH_d values of the various safety functions implemented through SAFEMASTER PRO, however, the effect of the safety components connected with SAFEMASTER PRO has to be taken into account (e.g. sensors and actuators), as described in EN ISO 13849-1, 2 or IEC 62061.

The implemented circuits and electrical diagrams and the system configuration Parameters values, including those of SAFEMASTER PRO, are under the full responsibility of the user.

STANDARD TOOL BAR

The standard tool bar is shown below. The meanings of the icons are listed below:



- | | | |
|------|---|---|
| 1 → |  | CREATE A NEW PROJECT |
| 2 → |  | CHANGE CONFIGURATION (arrangement of the different modules) |
| 3 → |  | CHANGE USER Parameters (name, company, etc.) |
| 4 → |  | SAVE THE ACTUAL PROJECT |
| 5 → |  | LOAD AN EXISTING PROJECT |
| 6 → |  | PRINT THE PROJECT SCHEMATIC |
| 7 → |  | SHOW PRINT PREVIEW OF PROJECT SCHEMATIC |
| 8 → |  | SHOW PRINT AREA OF PROJECT SCHEMATIC |
| 9 → |  | SNAP TO GRID |
| 10 → |  | PRINT THE PROJECT REPORT |
| 11 → |  | RESOURCES ALLOCATION |
| 12 → |  | UNDO MODIFICATION |
| 13 → |  | REDO MODIFICATION |
| 14 → |  | VALIDATE THE PROJECT |
| 15 → |  | CONNECT TO SAFEMASTER PRO |
| 16 → |  | SEND PROJECT TO SAFEMASTER PRO |
| 17 → |  | DISCONNECT FROM SAFEMASTER PRO |
| 18 → |  | READ PROJECT FROM SAFEMASTER PRO |
| 19 → |  | MONITOR (Real time I/O graphic) |
| 20 → |  | MONITOR (Real time I/O textual) |
| 21 → |  | DOWNLOAD LOG FILE |
| 22 → |  | SHOW SYSTEM CONFIGURATION |
| 23 → |  | DOWNLOAD ERRORS LOG |
| 24 → |  | DELETE ERRORS LOG |
| 25 → |  | SCHEMATIC SIMULATION |
| 26 → |  | GRAPHIC SIMULATION |
| 27 → |  | CHANGE PASSWORD |
| 28 → |  | ONLINE HELP |
| 29 → |  | PASSWORD RECOVERY |

CREATE A NEW PROJECT (CONFIGURE THE SAFEMASTER PRO SYSTEM)

Select icon CREATE  from the standard tool bar to start a new project.

The user authentication window is displayed.

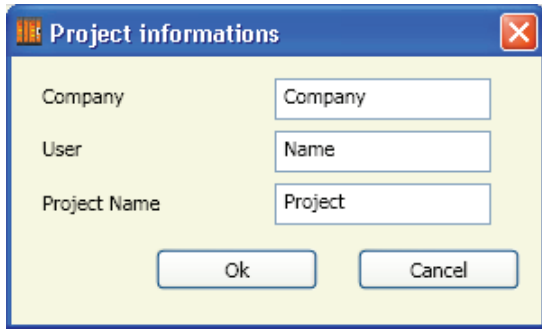

Next the SAFEMASTER PRO DESIGNER displays a window showing the UG 6911.12/080 only. It is possible to select the control module UG 6911.10 acting on the drop-down menu under the master module choosing the FW version. For UG 6911.10 it is < 5.0, for UG 6911.12/080 it is ≥ 5.0 and < 7.0.

You may add the various units needed to create your system, using the pull-down menus at the top of the screen (select slave) and at the bottom to select the relative node (0÷3).

The insertion order of modules is not important. Also the physical position of the modules need not be the same as in the configuration. For example, you can physically put the slave modules to the left of the master module. For some slave modules, it is also necessary to choose the type (UG 6917, UG 695x) by means of a second drop-down menu located below the node selection menu.

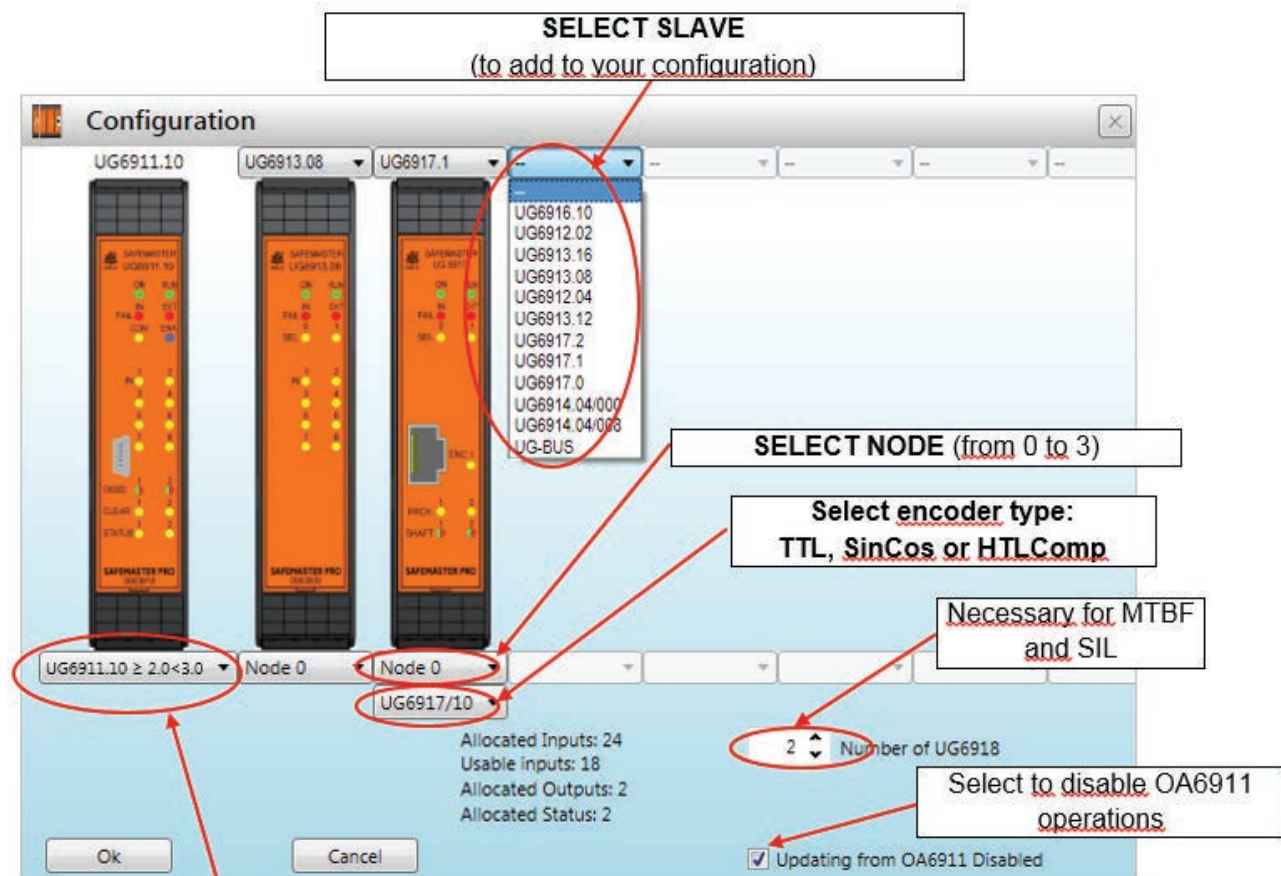

Selection of installed firmware in the control unit that should be configured.

See also section  "System composition".

EDIT CONFIGURATION (COMPOSITION OF THE VARIOUS UNITS)

The change of the system composition is obtained with the icon .

The configuration window is shown again.

CHANGE USER PARAMETERS

The change of user Parameters is obtained with the icon .

The dialog user identification request appears (see below). To accomplish this operation is not necessary to Log out from SAFEMASTER PRO. Generally it serves when a new user must create a new project (even using a previously created).

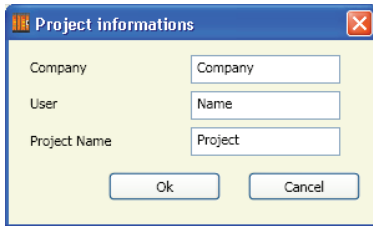

The dialog box titled "Project informations" contains the following fields and buttons:

- Company: [Company]
- User: [Name]
- Project Name: [Project]
- Buttons: Ok, Cancel

OBJECTS - OPERATOR - CONFIGURATION TOOL BARS

Four large tool windows are displayed to the left and right of the main window (see below):

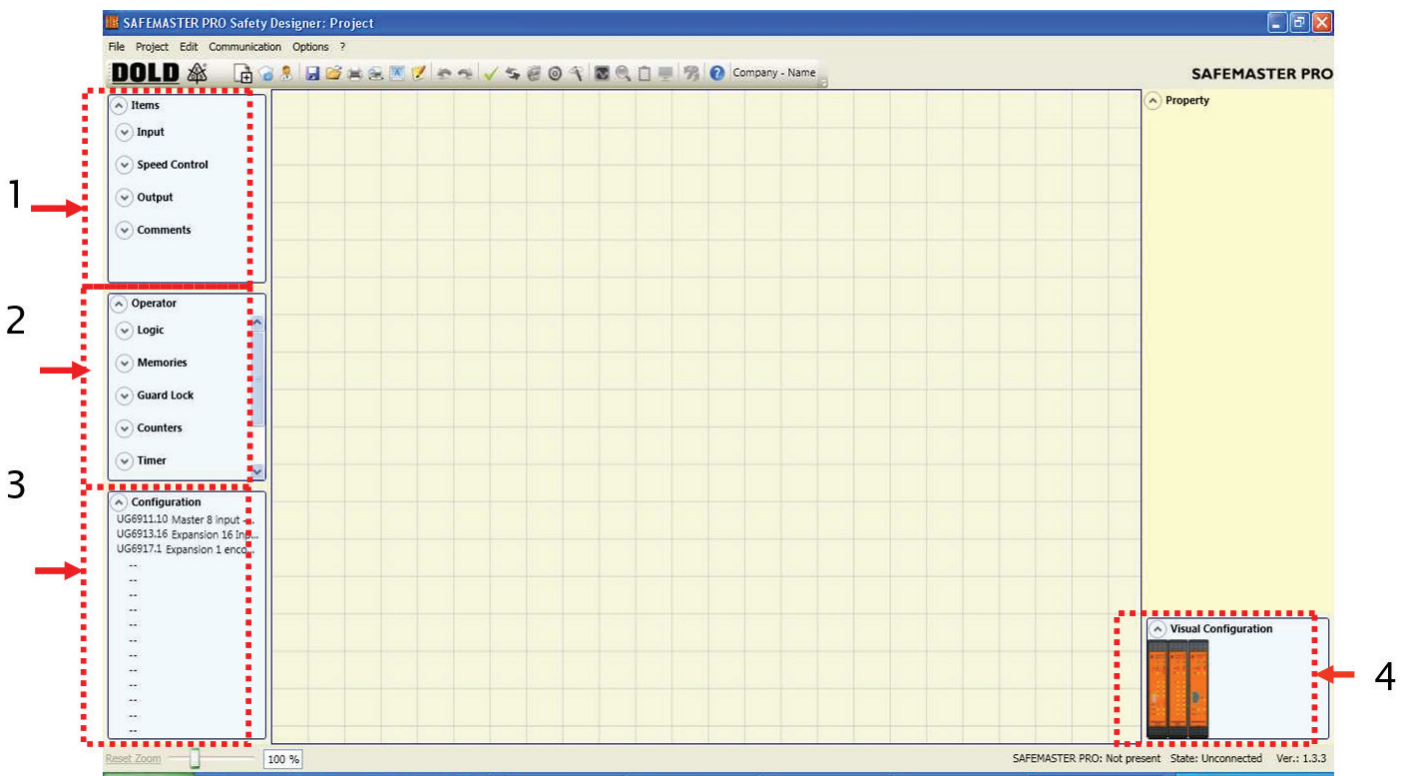

1 → OBJECT TOOL WINDOW

This contains the various input and output function blocks that will make up the project.

2 → OPERATOR TOOL WINDOW

This contains the various function blocks for connecting the objects in point 1; these blocks are divided into different types: logical, memories, counters etc.

3 → CONFIGURATION TOOL WINDOW

This contains the description of the project composition.

4 → CONFIGURATION TOOL WINDOW (view)

This contains the graphic representation of the project composition.

CREATING THE DIAGRAM

Once you have selected your system composition, you are ready to configure the project. The logic diagram is created using a **DRAG&DROP** function:

- Select the objects as required from the windows described previously (each single object is described in detail in the following sections) and drag it into the design area.
- Now when you select the object the **PROPERTIES** window is enabled, where you must fill in the fields as required.
- When you need to set a specific numerical value with a slide (e.g. filter) use the left and right arrows on your keyboard or click the sides of the slider of the slide.
- Connect the objects by moving the mouse over the required pin and then dragging it onto the pin to be connected.
- If the scheme requires the PAN function (moving working area in the window), select the object or area to move and use the arrow keys on your keyboard.
- When you need to duplicate an object, select it and press CTRL+C / CTRL+V keys on your keyboard.
- When you need to delete an object or a link, select it and press DEL key on your keyboard.
- By click with the right mouse key on object or object area more functions such as copy, insert and show description of object are available.

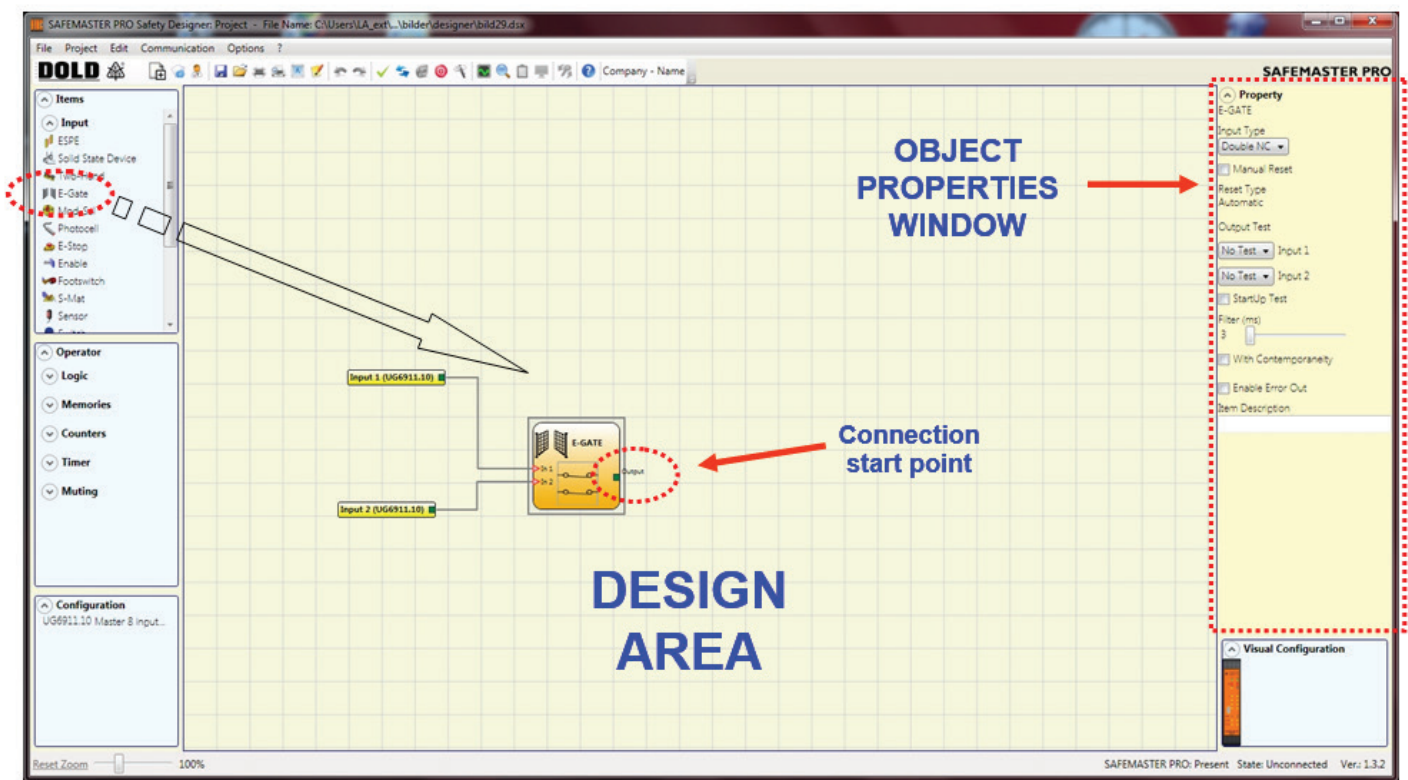

- If the scheme is very complicated and requires a connection between two elements very far, use the "Interpage" component. The element "Interpage out" must have a name which, invoked by the corresponding "Interpage in", allows the desired link.

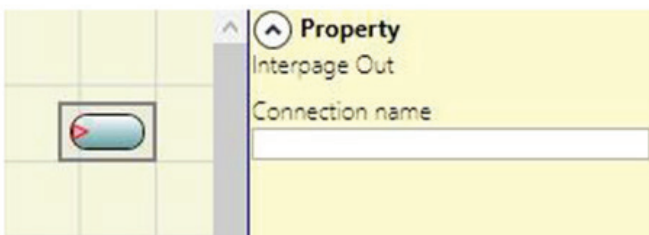

Left side of the diagram

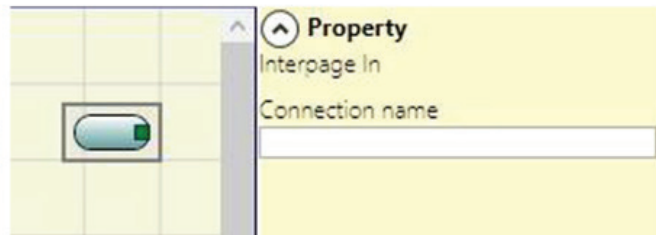

Right side of the diagram

CREATING THE DIAGRAM

- When you need to duplicate an object, select it and press CTRL+C / CTRL+V keys on your keyboard or click at the right mouse button and select context menu "Copy" and then "Paste".
- Wires position: It is possible to move the wires for a better graphic visibility of the scheme. To activate the function, simply place the mouse pointer and left click on the wire to be moved.

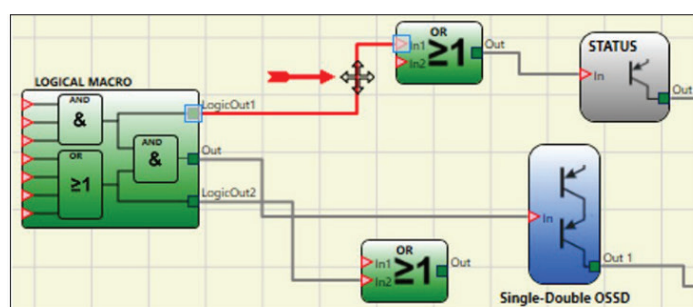
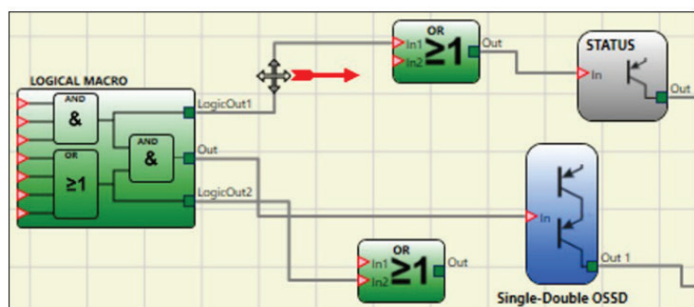

- When you need to delete an object or a link, select it and press DEL key on your keyboard.
- Find function: (press CTRL + F) allows you to make search within the scheme based on a search parameter. Research does not distinguish between upper and lower case.

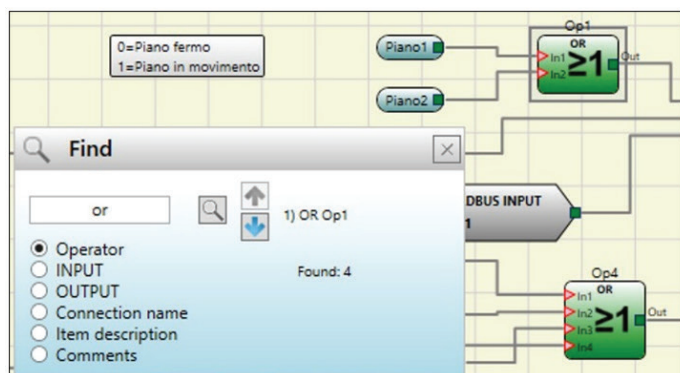

Find Operator

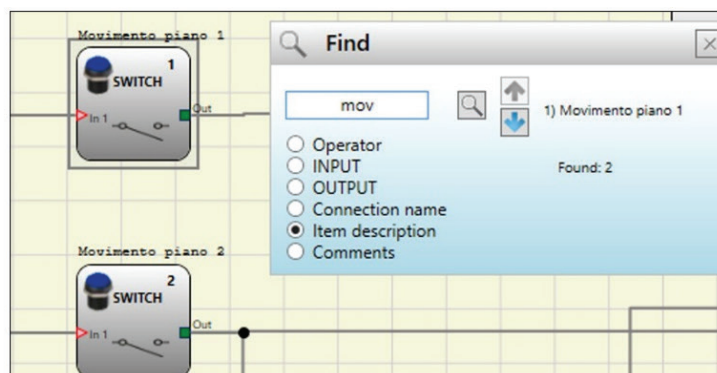

Find item description

USE OF MOUSE RIGHT BUTTON

ON block input / output

- Copy / Paste
- Delete
- Delete all the assigned pins
- Alignment with other functional blocks (multiple selection)
- On-line Help
- on block Status: enable / disable input pin logical negation
- Monitor Mode: Show / Hide Properties window

ON Block operators

- Copy / Paste
- Delete
- Alignment with other functional blocks (multiple selection)
- On-line Help
- On input pin: activate / deactivate logical negation
- Monitor Mode: Show / Hide Properties window

ON input / output terminals

- Alignment with other inputs / outputs

ON connection (wires)

- Delete
- Display full path of the connection (network)

PRINT LOGIC DIAGRAM

For print function, 3 symbols are available:



The logic diagram is always one complete picture that can be printed via this symbol. Depending on printer configuration, the logic diagram is cut in several pages.



Print preview can be show with this symbol.



With this symbol, the distribution of the logic diagram to the pages to be printed can be show during generation of the plan. Grey lines show that no objects or function blocs are cut in 2 pages, red lines shows that symbols may be cut at printing.

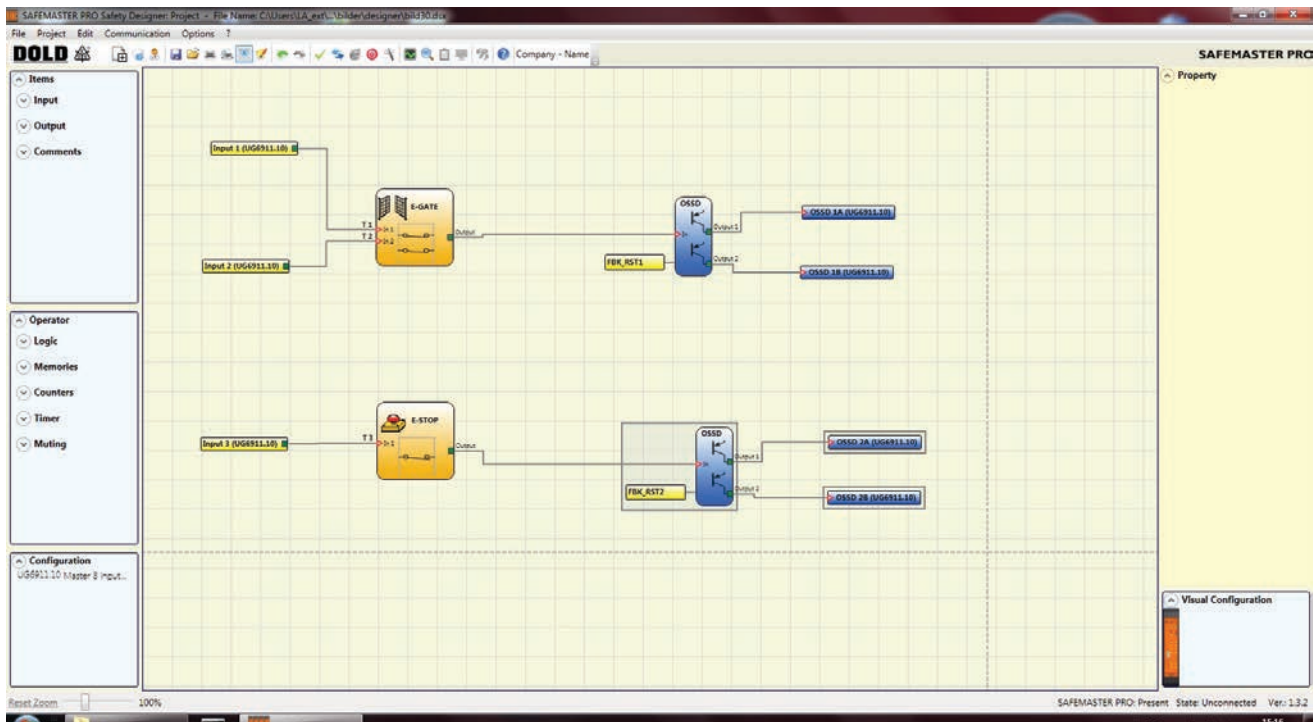

Symbols correctly placed

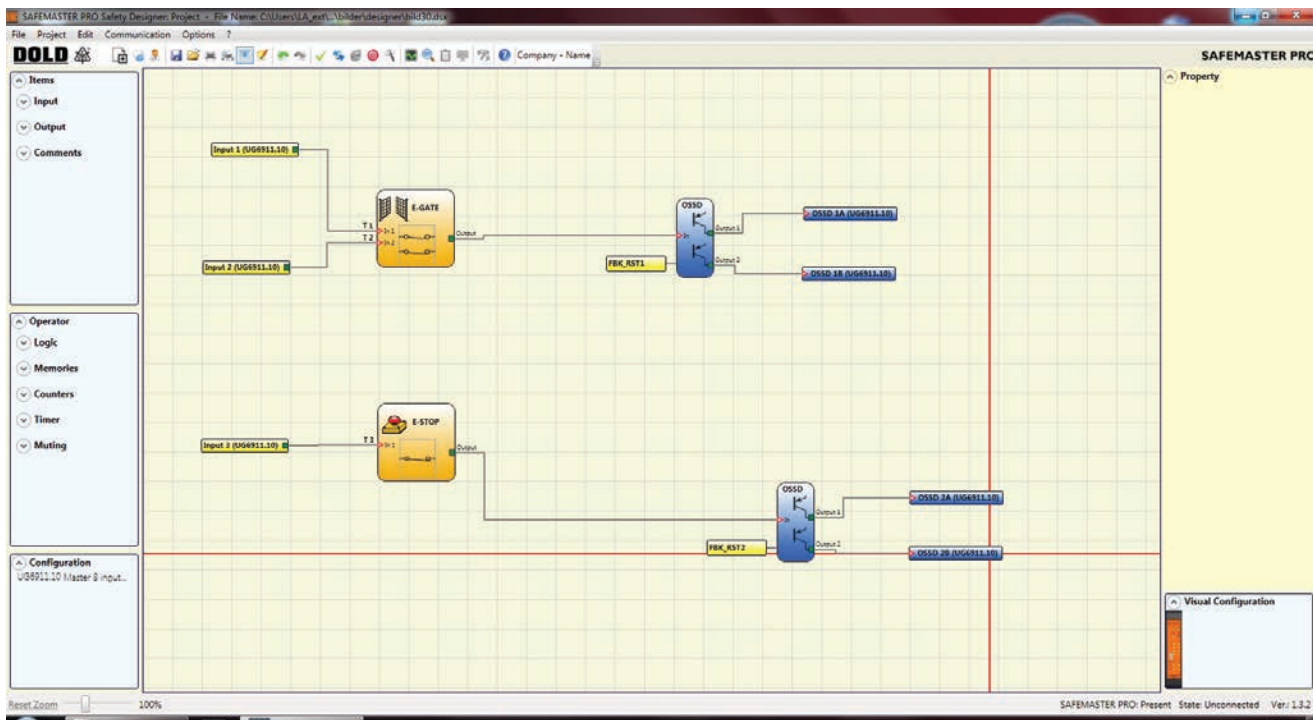



Placement not OK

EXAMPLE OF A PROJECT

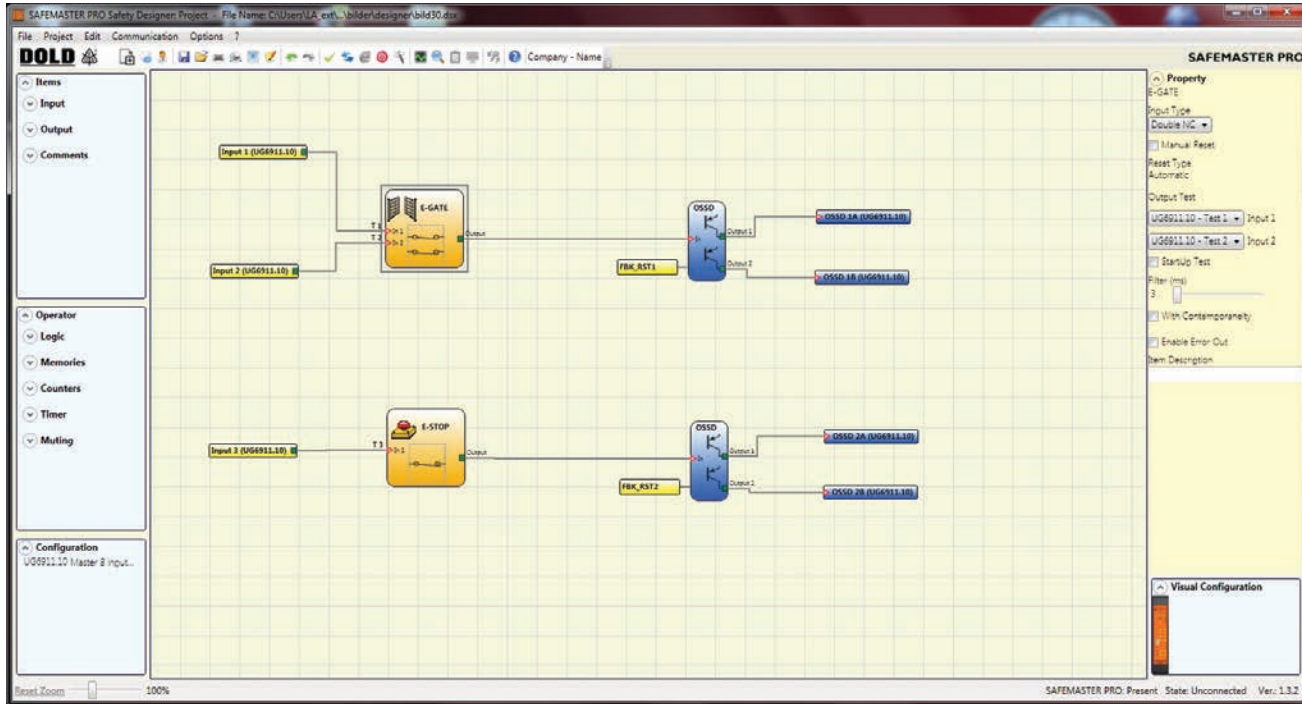

This Example shows an example of a project in which the UG 6911.10 unit only is connected to two safety blocks (E-GATE and E-STOP). The UG 6911.10 inputs (1, 2, and 3) for connecting the contacts of the safety components are shown on the left, in yellow. The SAFEMASTER PRO outputs (from 1 to 4) are activated according to the conditions defined in E-GATE and E-STOP (see the E-GATE - E-STOP sections).

By clicking on a block to select it, you enable the PROPERTIES WINDOW on the right, which you can use to configure the block activation and test Parameters (see the E-GATE - E-STOP sections).



At the end of the project design stage (or at intermediate steps) you can save the current configuration using the icon  on the standard tool bar.

Project validation



 Now the finished project must be verified. Execute the VALIDATE command (Icon  on the standard toolbar)

If the validation is successful, a sequential number is assigned to the input and output of the project. Then, this number is also listed in the REPORT and in the MONITOR of SAFEMASTER PRO DESIGNER.

Only if the validation is successful we will proceed to send the configuration.

 The validation function only verifies the consistency of programming with respect to the characteristics of the SAFEMASTER PRO system. It does not guarantee that the device has been programmed to meet all the safety requirements for the application.

Resources Allocation (without illustration)

 To activate the Resources Allocation function use the icon . Executing this command, all the used elements among Inputs, Outputs, Status, Fieldbus input and Probe are visible

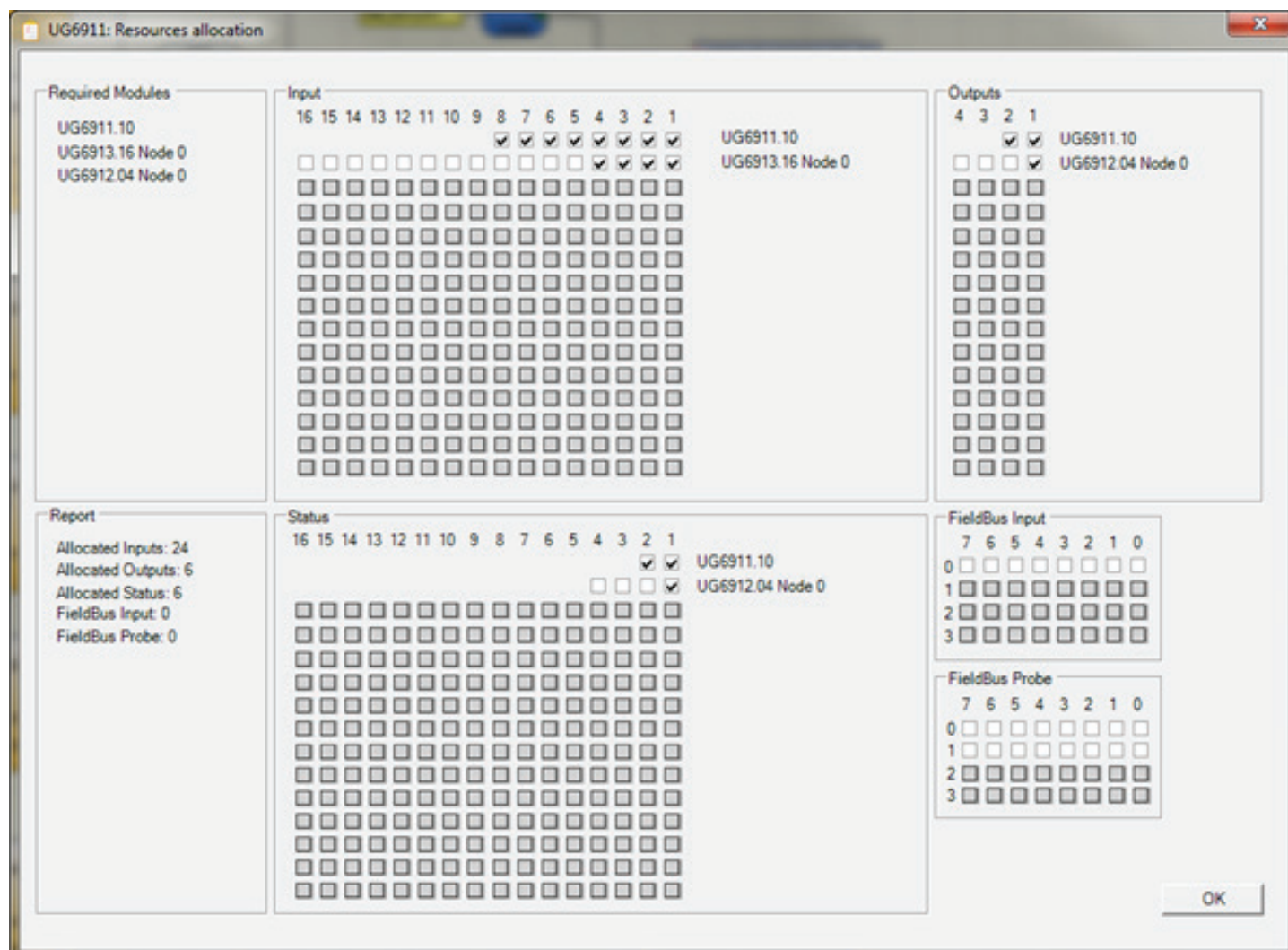

UG6911: Resources allocation

Required Modules
 UG6911.10
 UG6913.16 Node 0
 UG6912.04 Node 0

Input
 16 15 14 13 12 11 10 9 8 7 6 5 4 3 2 1
 UG6911.10
 UG6913.16 Node 0

Outputs
 4 3 2 1
 UG6911.10
 UG6912.04 Node 0

Report
 Allocated Inputs: 24
 Allocated Outputs: 6
 Allocated Status: 6
 FieldBus Input: 0
 FieldBus Probe: 0

Status
 16 15 14 13 12 11 10 9 8 7 6 5 4 3 2 1
 UG6911.10
 UG6912.04 Node 0

FieldBus Input
 7 6 5 4 3 2 1 0
 0
 1
 2
 3

FieldBus Probe
 7 6 5 4 3 2 1 0
 0
 1
 2
 3

OK

PROJECT REPORT

Print of the System composition with properties of each block.

(Icon  on the standard toolbar).

**Warning**

The PFH_d , $MTTF_d$ and DC_{avg} values which are shown in "Project report - SAFEMASTER PRO - Safety information" refer exclusively to the internal operation of SAFEMASTER PRO.

For the calculation of the total PFH_d values of the various safety functions implemented through SAFEMASTER PRO, however, the effect of the safety components connected with SAFEMASTER PRO has to be taken into account (e.g. sensors and actuators), as described in EN ISO 13849-1, 2 or IEC 62061.

The implemented circuits and electrical diagrams and the system configuration Parameters values, including those of SAFEMASTER PRO, are under the full responsibility of the user.

DOLD & SÖHNE KG

Project Report generated by SAFEMASTER PRO Safety Designer version 1.3.2

Project Name: Zweihand_Enable

User: Name

Company: Company

Date: 10.01.2014 11:07:46

Schematic CRC: 0102H

SAFEMASTER PRO: Configuration

Module UG6911.10 (Configured Firmware version: FW \geq 0.4 $<$ 1.0)

SAFEMASTER PRO: Safety Information's

PFH_d (according to IEC 61508): 6,06E-009 (1/h)

$MTTF_d$ (according to EN ISO 13849-1): 100 years

DC_{avg} (according to EN ISO 13849-1): 97.90 %

Attention!

This definition of PL and of the other related parameters as set forth in ISO 13849 1 only refers to the functions implemented in the SAFEMASTER PRO system by the SAFEMASTER PRO configuration software, assuming configuration has been performed correctly.

The actual PL of the entire application and the relative parameters must consider data for all the devices connected to the SAFEMASTER PRO system within the scope of the application.

This task and any other aspect of system configuration are the exclusive responsibility of the user/installer.



CONNECT TO SAFEMASTER PRO

After connecting the control unit UG6911.10 to the PC via CSU cable OA 6920 (USB) use the icon  for the connection. A window appears to request the password. Enter the password (see "Password protection").



SENDING THE CONFIGURATION TO THE SAFEMASTER PRO

To send the saved configuration from a PC to UG6911.10 (or UG6911.12/080) use the icon  on the standard toolbar and wait the execution. The control unit will save the project in its internal memory and (if present) in OA 6911 memory. (Password Required: level 2).

 This function is possible only after the project validation with OK result.

 If the firmware version in the control unit is not identical to the selected firmware version of the configuration file, a failure message is displayed as shown right (example) and the configuration is not transferred.

 To transfer the configuration, the configuration file has to be set to the same firmware status as it is installed in the control unit. See also section "Create a new project (configure the SAFEMASTER PRO system)".

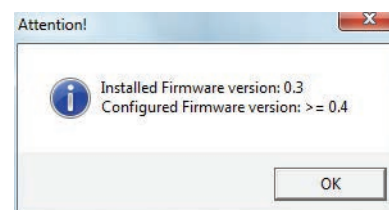

DOWNLOAD A CONFIGURATION FROM A SAFEMASTER PRO

Use the icon  on the Standard toolbar to download a project from SAFEMASTER PRO to SAFEMASTER PRO Designer. (Password level 1 is sufficient).

 If the project shall be used on other Safemaster Pro systems verify the modules effectively connected.

 Then perform a "Project Validation" and a "Testing the System".

 In this phase Safemaster Pro Designer (version 1.9.0 and higher) reads the original msx file contained in the base modules UG 6911.10 or UG 6911.12/080 with the blocks, comments, etc. (as drawn by the designer).

CONFIGURATION LOG

 Within the configuration file (project), are included the **creation date** and **CRC (4-digit hexadecimal identification)** of a project that are stored in UG 6911.10 (or UG 6911.12/080).

 This logbook can record up to 5 consecutive events, after which these are overwritten, starting from the least recent event.

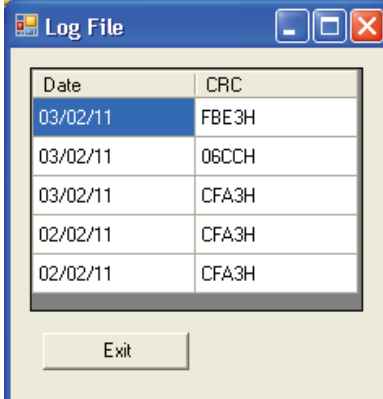

The image shows a 'Log File' dialog box with a table containing the following data:

Date	CRC
03/02/11	FBE3H
03/02/11	06CCH
03/02/11	CFA3H
02/02/11	CFA3H
02/02/11	CFA3H

Below the table is an 'Exit' button.

The log file can be visualized using the icon  in the standard tool bar. (Password Required: level 1).

SYSTEM COMPOSITION

The check of the actual composition of the SAFEMASTER PRO system is obtained using the icon  (Password Required: level 1)

A pop-up window will appear with:

- Connected units;
- Firmware version of each unit;
- Node number (physical address) of each unit.

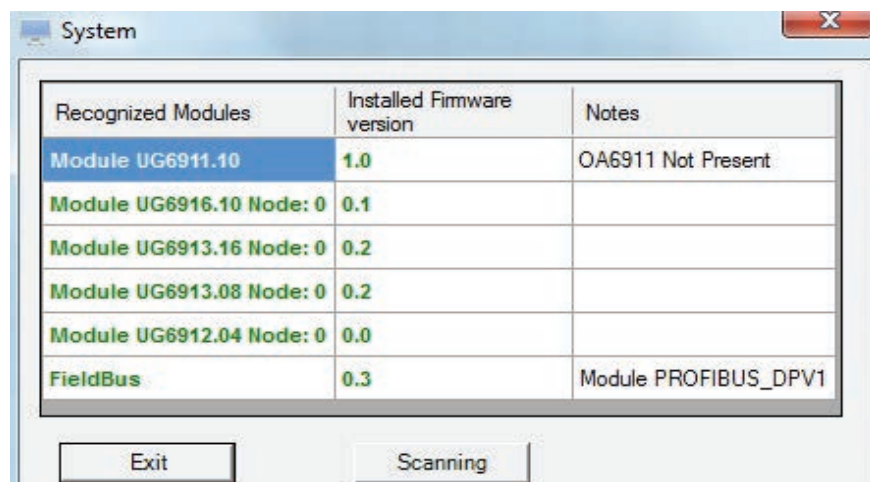

If the modules found are not correct the following window will appear; e.g. UG 6916.10 node number not correct (displayed in red color text).

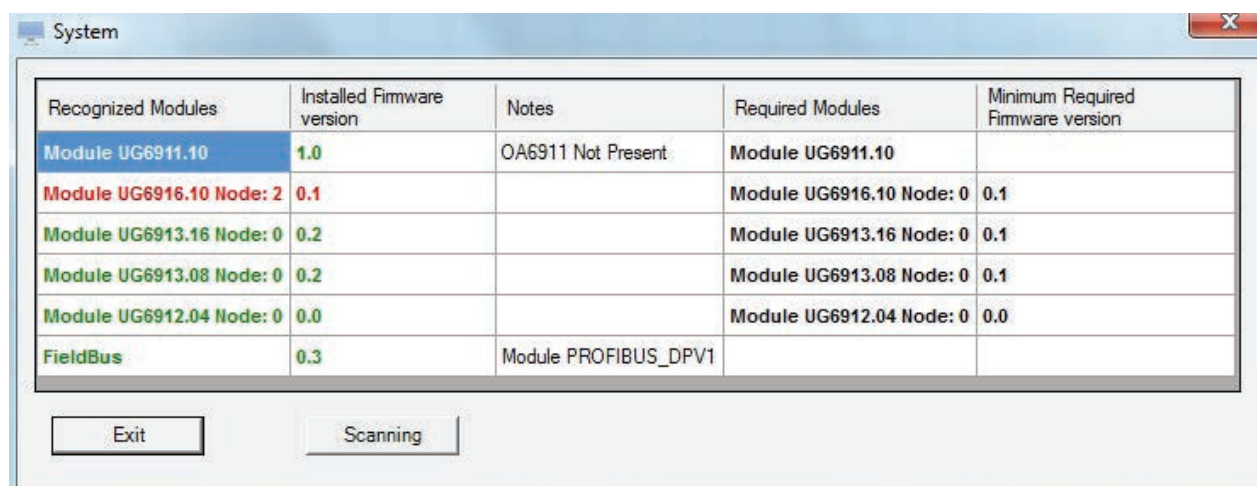

DISCONNECTING SYSTEM

To disconnect the PC from UG6911 use the icon ; when the system is disconnected it is reset and it starts with the sent project.

 If the system is not composed of all units provided by the configuration, after the disconnection, UG 6911.10 indicates the incongruity and does not start. (see Visualizations and Error codes from SAFEMASTER PRO Designer).

ERROR CODES FROM SAFEMASTER PRO DESIGNER

In case of malfunction the SAFEMASTER PRO system transmits to the SAFEMASTER PRO Designer a code corresponding to the error detected by the UG6911.10 unit.

To read the code, proceed as follows:

- Connect the UG6911.10 (indicating Fail) to the PC using the USB-cable
- Launch the SAFEMASTER PRO Designer, a window appears with the error code occurred.

The following table lists all possible errors detected and their solution:

CODE	FAIL	RESOLUTION
19D	The two UG6911 microcontrollers do not see the same hardware / software configuration	Check correct insertion of UG 6911 and expansions modules in In-Rail Bus
66D	2 or more same expansion modules with the same node number	Check the connections of Pins 2 and 3 of the expansions modules
68D	Exceeded max expansion modules number	Disconnect the modules in excess (max. 14)
70D	One or more modules have detected a change in the node number	Check the connections of Pins 2 and 3 of the expansions modules
73D	A slave module has detected an external error	Check the error code on module for more information
96D ÷ 101D	Errors related to memory card OA6911	Replace memory card OA 6911

CODE	UG 6914 FAIL	RESOLUTION
137D	EDM error on the couple Relay 1 and 2 used in Category 4	Check the connection of the external feedback contactors
147D	EDM error on the couple Relay 2 and 3 used in Category 4	
157D	EDM error on the couple Relay 3 and 4 used in Category 4	

CODE	UG 6917 FAIL	RESOLUTION
133D (Proxi1) 140D (Proxi2)	Over-frequency detected on Proximity input	The input frequency must be ≤ 5 kHz
136D (Encoder1) 143D (Encoder2)	Input signals not standard (duty cycle, phase displacement)	<ul style="list-style-type: none"> • DUTY CYCLE must be 50 % ± 33 % of the PERIOD (HTL, TTL) • The phase displacement must be 90° ± 33 % (HTL, TTL) (not applicable to sin / cos)
138D (Encoder1) 145D (Encoder2)	Over-frequency detected on Encoder input	The input frequency must be < 500 kHz (TTL, sin / cos); < 300 kHz (HTL).

CODE	FAIL	RESOLUTION
130D 135D 137D 138D 140D 194D 197D 198D 199D 201D 202D 203D 205D	Errors solid state output OSSD1	Check the OSSD1 connection relative to the module in error
144D 149D 151D 152D 154D 208D 211D 212D 213D 215D 216D 217D 219D	Errors solid state output OSSD2	Check the OSSD2 connection relative to the module in error
158D 163D 165D 166D 168D 222D 225D 226D 227D 229D 230D 232D 233D	Errors solid state output OSSD3	Check the OSSD3 connection relative to the module in error
172D 177D 179D 180D 182D 236D 239D 240D 241D 243D 244D 245D 247D	Errors solid state output OSSD4	Check the OSSD4 connection relative to the module in error

All other codes are related to errors or an internal malfunction.

Please replace the module that gave the error or return to DOLD for repair and / or debugging.

ERROR CODES FROM SAFEMASTER PRO DESIGNER

CODE	FAIL	RESOLUTION
1D ÷ 31D	Microcontroller error	Try to restart the system. If the error persists, send unit to DOLD Laboratory for repair.
32D ÷ 63D	Mainboard error	
64D ÷ 95D	Communication error between units	
96D ÷ 127D	Errors related to memory card OA6911	Replace memory card OA 6911
128D ÷ 138D	Error module UG6914 relay 1	Try to restart the system. If the error persists, send unit to DOLD Laboratory for repair.
139D ÷ 148D	Error module UG6914 relay 2	
149D ÷ 158D	Error module UG6914 relay 3	
159D ÷ 168D	Error module UG6914 relay 4	
128D ÷ 146D	Error modules UG6917- Encoder Eingang	Try to restart the system. If the error persists, send unit to DOLD Laboratory for repair.
128D ÷ 142D	Error module UG6912.04/100 OSSD1	
143D ÷ 156D	Error module UG6912.04/100 OSSD2	
157D ÷ 170D	Error module UG6912.04/100 OSSD3	
171D ÷ 184D	Error module UG6912.04/100 OSSD4	
128D ÷ 143D	Error modules UG6911.12/080, UG6916.12/080 OSSD1	
144D ÷ 158D	Error modules UG6911.12/080, UG6916.12/080 OSSD2	
159D ÷ 173D	Error modules UG6911.12/080, UG6916.12/080 OSSD3	
174D ÷ 188D	Error modules UG6911.12/080, UG6916.12/080 OSSD4	
192D ÷ 205D	Error modules UG6911.10, UG6916.10, UG6912.02, UG6912.04 OSSD1	
206D ÷ 219D	Error modules UG6911.10, UG6916.10, UG6912.02, UG6912.04 OSSD2	
220D ÷ 233D	Error modules UG6912.04 OSSD3	
234D ÷ 247D	Error module UG6912.04 OSSD4	

ERROR LOG DOWNLOAD

The error log file from U6911.10, UG6911.12/080 can be visualized using the icon  in the standard toolbar. (Password level 1 required).

A table will appear with the last 5 errors occurred from the date when the schema was sent to SAFEMASTER PRO or from the date of error log cancellation (icon .

MONITOR (I/O STATUS IN TEXTUAL)

To activate the MONITOR use the icon . (Password Required: level 1).

A pop-up window will appear (in real time) with:

- Status of the inputs (when the object has two or more input connections to SAFEMASTER PRO, the MONITOR will show as active only the first), see the example in figure
- Inputs Diagnostics;
- OSSD State;
- OSSD Diagnostics;
- Status of digital outputs;
- OUT TEST diagnostics.

Module	block	Type	INPUT	State	Input diagnostic	Module	OSSD	State	OSSD diagnostic	Module	Status	State	OutTest	OutTest diagnostic
UG6911.10	1	E-Gate	IN1	OFF		UG6911.10	OSSD1	OFF		X			UG6911.10 T1	
			IN2			UG6911.10	OSSD2	ON		X			UG6911.10 T2	
UG6911.10	2	E-Stop	IN3	ON									UG6911.10 T3	
			X										UG6911.10 T4	
			X											
			X											
			X											
			X											

Textual monitor

MONITOR (I/O STATUS IN REAL TIME - TEXTUAL - GRAPHIC)

To activate/deactivate the monitor use the icon . (Password Required: level 1).

The color of links allows you to view the diagnostics (in real time) with:

- **RED** = OFF
- **GREEN** = ON
- **DASHED ORANGE** = Connection Error
- **DASHED RED** = Pending enable (for example RESTART)

Placing the mouse pointer over the link, you can display the diagnostics

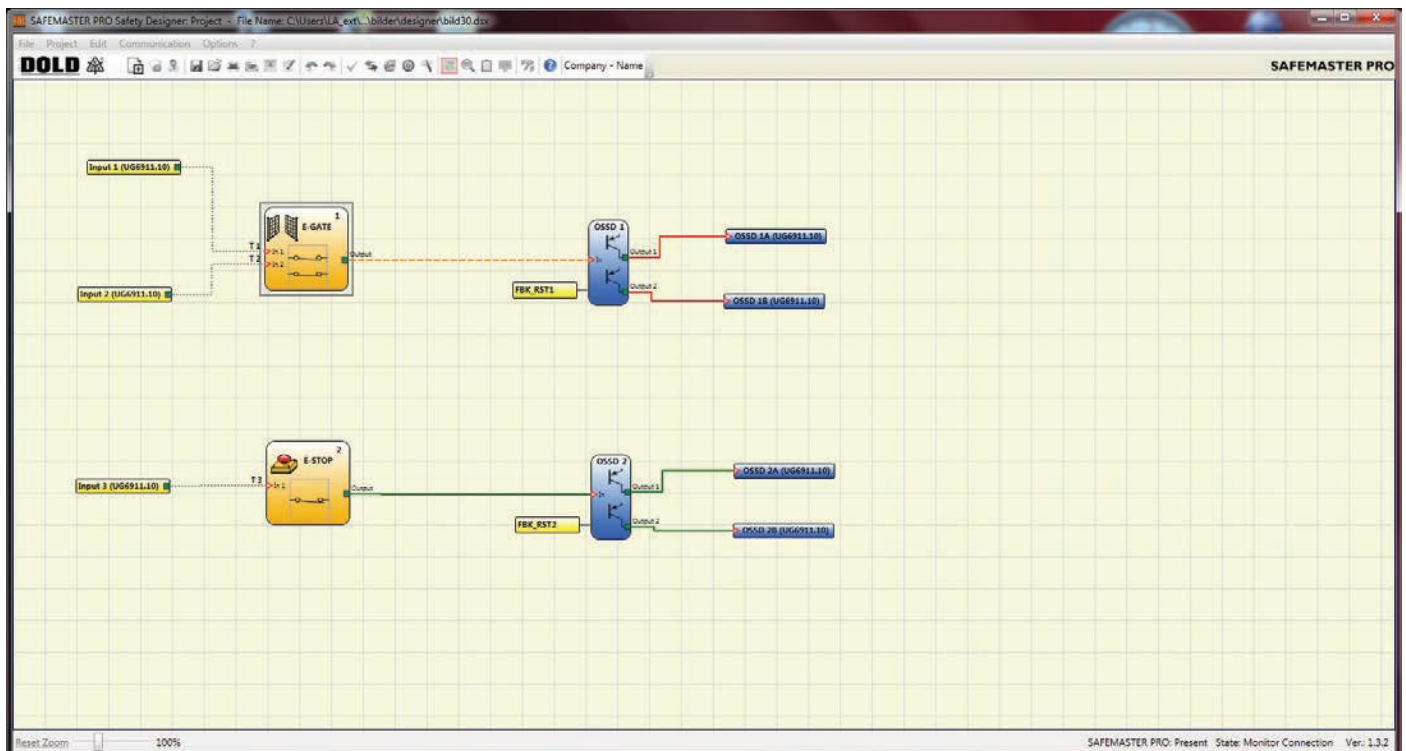

Graphic monitor

PASSWORD PROTECTION

The SAFEMASTER PRO DESIGNER requests a password in order to upload and save the project.

LEVEL 1 PASSWORD

All operators using the UG 6911.10 system must have a Level 1 PASSWORD.

This Password allows only to view the LOG file, composition of the system and MONITOR in real time.

The first time the system is initialized the operator must use the password "" (ENTER key).

Designers who know the level 2 password can enter a new level 1 password (alphanumeric, max 8 characters).



 Operators who know this password **are not enabled** to upload, modify or save the project

LEVEL 2 PASSWORD

Designers authorized to work on the creation of the project must know a Level 2 PASSWORD. The first time the system is initialized the operator must use the password "SAFEPASS" (all capital letters).

Designers who know the level 2 password can enter a new level 2 password (alphanumeric, max 8 characters).

 This password enables the project to be uploaded, modified and saved. In other words, it allows total control of the PC → SAFEMASTER PRO system. When a new project is UPLOADED the level 2 password could be changed.

 Should you forget either of these passwords, please contact DOLD which will provide an unlock file. When this file is saved in the directory in which the SAFEMASTER PRO DESIGNER software is installed, the following icon  appears in the standard tool bar.

Now it is possible to restore the original password "" and "SAFEPASS" in the control unit, (the control unit must be switched on and connected to the PC).

This procedure can only be done once for every control unit.

For a second reset the control unit has to be sent back to the manufacturer

PASSWORD CHANGE

To activate the PASSWORD Change use icon , after connecting with Level 2 Password.

A window appears allowing the choice of the new password; insert the old and new passwords in the appropriate fields (max 8 characters). Click OK.

At the end of the operation disconnect to restart the system.

If memory card OA 6911 is present the new password is also saved in it.



TESTING THE SYSTEM

 After validating and uploading the project to the UG6911.10 (or UG6911.12/080 and connecting all the safety devices, you must test the system to verify its correct operation

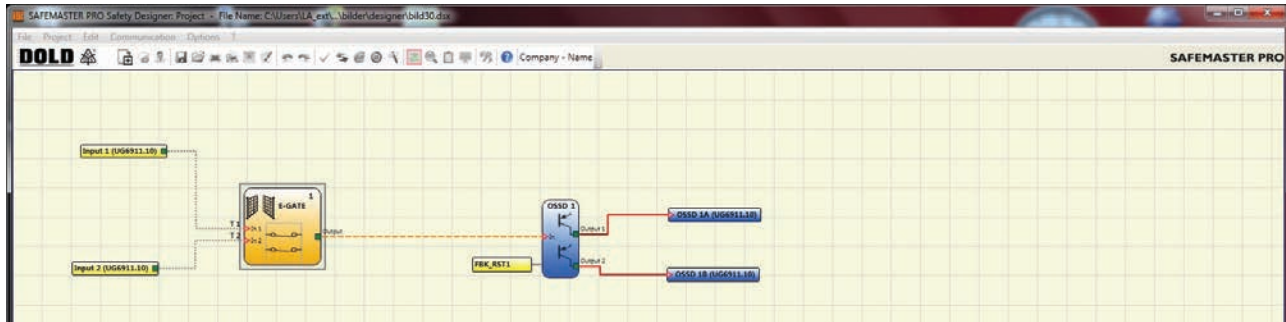

This is done by forcing a change of status for each safety device connected to the SAFEMASTER PRO to check that the status of the outputs actually changes.

The following example is helpful for understanding the TEST procedure.

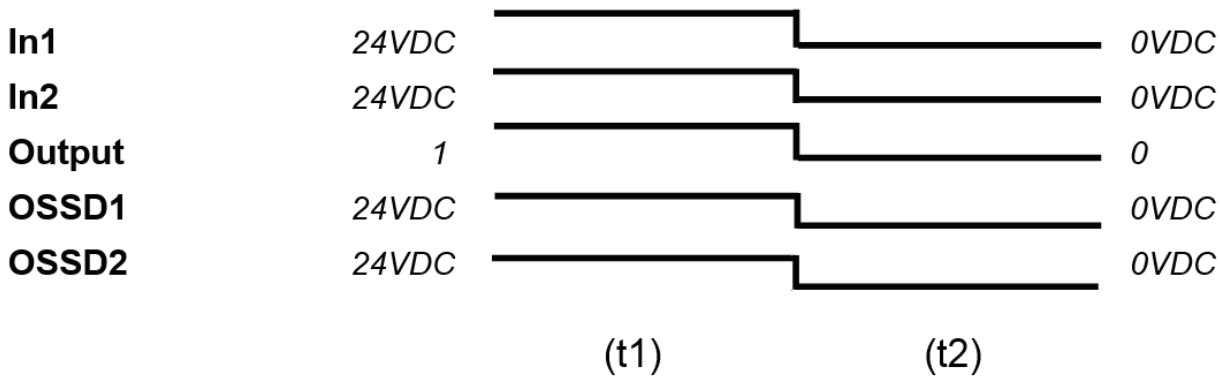

- (t1) In the normal operating condition (E-GATE closed) Input1 and Input2 are closed and the output of the E-GATE block is set to high logic level; in this mode the safety outputs (OSSD1/2) are active and the power supply to the relative terminals is 24 V DC.
- (t2) When the E-GATE is physically opened, the condition of the inputs and thus of the outputs of the E-GATE block will change: (Output = 1 → 0); the condition of the OSSD1 OSSD2 safety outputs will change from 24 V DC to 0 V DC. If this change is detected the mobile E-GATE is connected correctly.



 For the correct installation of each external sensor/component refer to their installation manual.
 This test must be performed for each safety component in the project.

OBJECT FUNCTIONS BLOCKS

OUTPUT OBJECTS

OSSD (safety outputs)

The OSSD semiconductor safety outputs require no maintenance, Output1 and Output2 supply 24 V DC if the input is 1 (TRUE), whereas they supply 0 V DC if the input is 0 (FALSE).

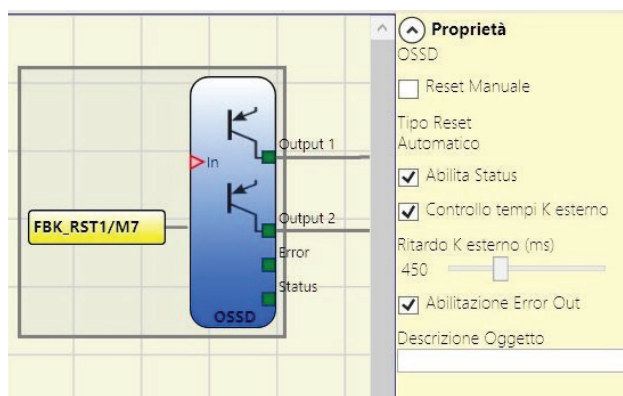

 Each pair of OSSD has an entrance on RESTART_FBK. This input must always be connected as described in paragraph RESTART_FBK

Parameters

Manual Reset:

If selected this enables the request to reset each time the input signal falls. Otherwise, enabling of the output directly follows the input conditions.

There are two types of reset: Manual and Monitored. When Manual is selected the system only verifies the signal's transition from 0 to 1. If Monitored is selected the double transition from 0 to 1 and then back to 0 is verified.

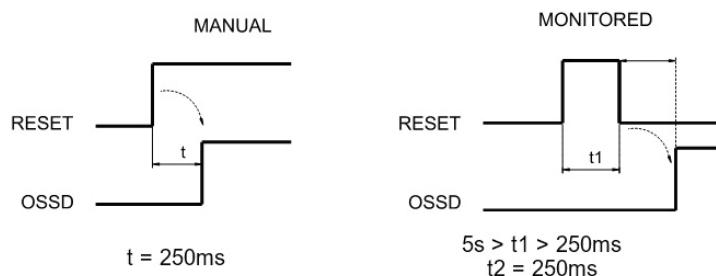

Enable Status:

If selected, a status output is available for connection to the logic diagram.

K external time check:

If selected, enables the setting of the time window within which the external feedback signal is to be monitored (according to output conditions).

With high level (TRUE) OUTPUT, the FBK signal must be at low level (FALSE) and vice versa, within the set time

OUTPUT	FBK	ERROR	LED CLEAR UG 6911.10, UG 6911.12/080
1	0	0	0
0	1	1	Flashing

Parameters

Enable Error Out:

If selected, enables the ERROR OUT output. This output is set to high level (TRUE) when an external FBK error is detected. The signal is reset in case of one of the following events:

1. Switching on and switching off of system
2. Activation of the RESET UG 6911 operator.

Item Description:

This allows a description of the component's function to be entered. The text is displayed in the top part of the symbol

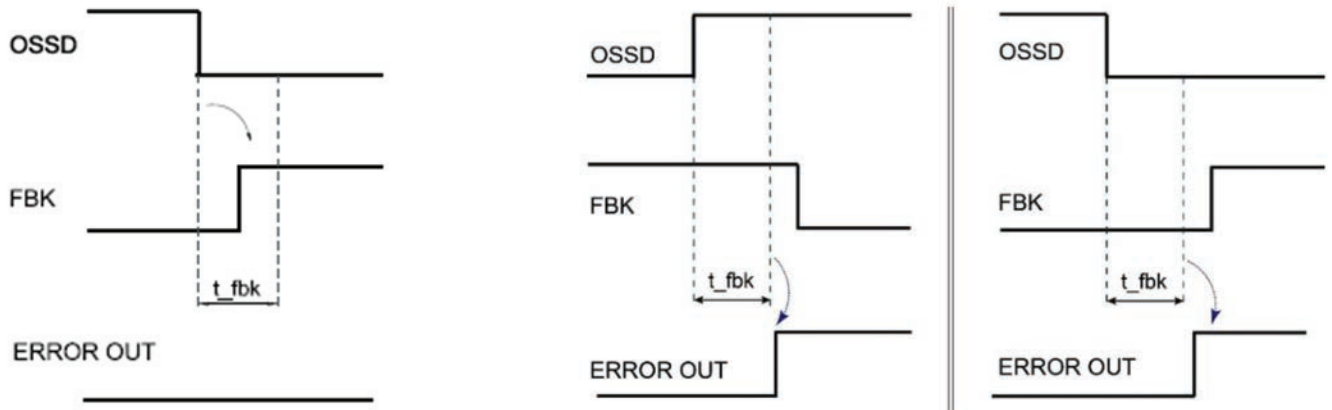

Example of OSSD with correct Feedback signal:
In this case ERROR OUT = FALSE

Example of OSSD with incorrect Feedback signal
(k external time exceeded):
In this case ERROR OUT = TRUE

OSSD feedback unconnected:

If selected, the feedback must not be connected.

If not selected the feedback must be connected directly to 24 V or through the series of NC contacts of K1/K2.

 This parameter is only applicable to the following modules:

- UG 6911.10 with firmware version ≥ 4.1
- UG 6916.10 with firmware version ≥ 0.11
- UG 6912.02, UG69 12.04 with firmware version ≥ 0.7
- UG 6912.04/100 with firmware version > 0.1

SINGLE-DOUBLE OSSD (safety output)

The SINGLE-DOUBLE OSSD use semiconductor technology. Out1 and Out2 are set to 24 V DC if the input In is 1 (TRUE), whereas they are set to 0 V DC if the input In is 0 (FALSE).

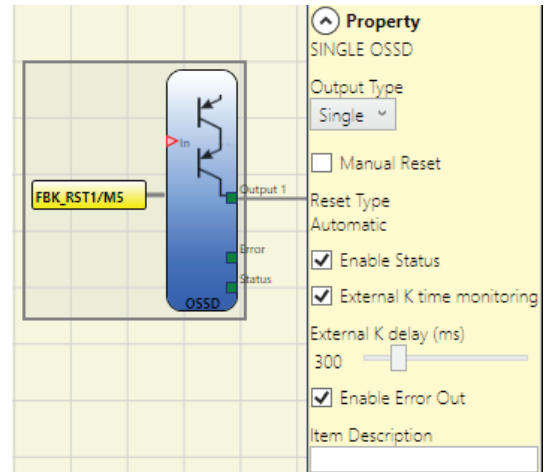

 Each single OSSD output has a related RESTART_FBK input. In the case of UG 6911.12/080 and UG 6916.12/080 this input only appears if the manual reset or the external K time control is activated. In the case of UG 6912.04/100 it always appears and must be connected as indicated in the RESTART_FBK paragraph.

Parameters



Output Types:

There is a choice of 2 different output types:

- Single Output Type
- Double Output Type

Using UG 6911.12/080, UG 6916.12/080 or UG 6912.04/100 module the operator can choose between different configurations:

1. Four SINGLE OUTPUTS function blocks (single output type)
2. Two SINGLE OUTPUTS function blocks (double output type)
3. Four SINGLE OUTPUTS function blocks (single output type) + one SINGLE OUTPUTS function block (double output type)

 Using single channel OSSDs, to maintain Safety Integrity Level (SIL) 3 requirements, the OSSD outputs must be independent.
 Common cause failures between OSSD outputs must be excluded by an appropriate cable installation (e.g. separate cable paths).

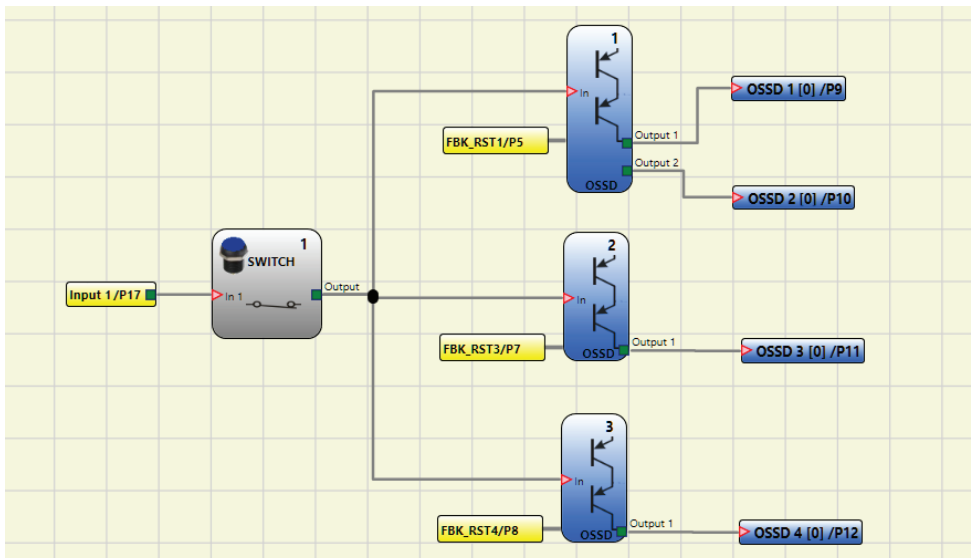

Example: 2 single output type function blocks + 1 double output type function block

Parameters

below you can find the explanation of the four SINGLE OSSD configurations of the modules UG 6911.12/080, UG 6916.12/080 and UG 6912.04/100:

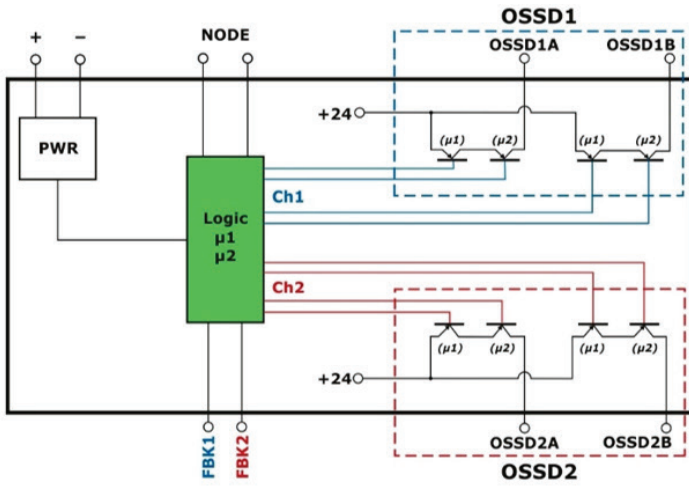

Configuration with 2 dual channel outputs (safety category SIL3 / PL e)

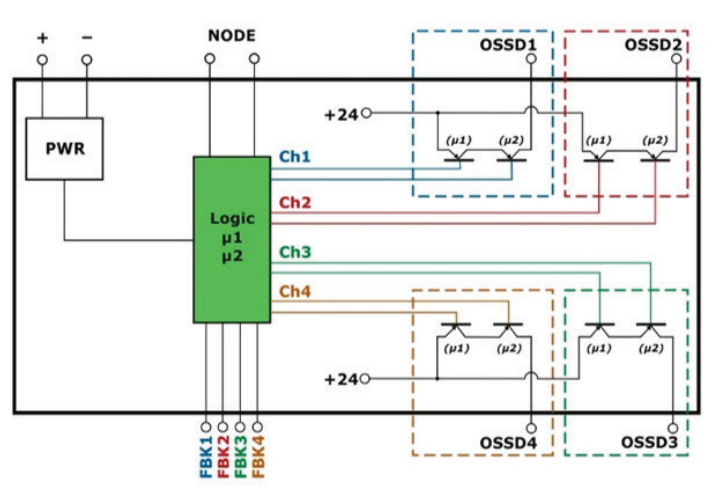

Configuration with 4 single outputs (safety category SIL3 / PL e)

Manual Reset:

If selected this enables the request to reset each time the input signal falls. Otherwise, enabling of the output directly follows the input conditions.

There are two types of reset: Manual and Monitored. When Manual is selected the system only verifies the signal's transition from 0 to 1. If Monitored is selected the double transition from 0 to 1 and then back to 0 is verified.

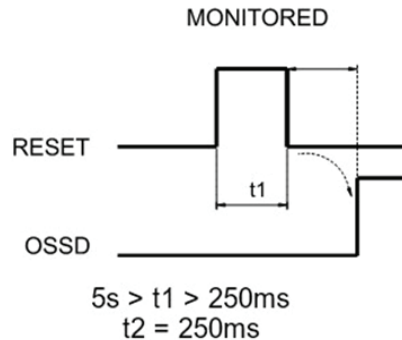
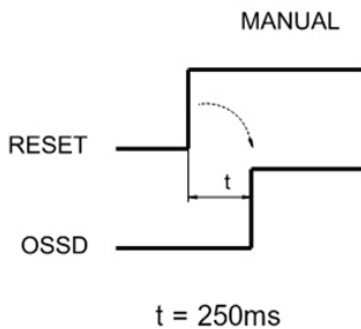

Enable Status:

If selected, the connection of the current OSSD state to any point on the screen is enabled.

K external time check:

If selected, enables the setting of the time window within which the external feedback signal is to be monitored (according to output conditions).

With high level (TRUE) OUTPUT, the FBK signal must be at low level (FALSE) and vice versa, within the set time. Otherwise, OUTPUT is set to low level (FALSE) and the error is indicated on the control unit UG 6911 by the flashing CLEAR LED of the corresponding OSSD error.

OUTPUT	FBK	ERROR	LED CLEAR UG 6911.10, UG 6911.12/080
1	0	0	0
0	1	1	Flashing

Parameters

Enable Error Out:

If selected, enables the ERROR OUT output. This output is set to high level (TRUE) when an external FBK error is detected. The signal is reset in case of one of the following events:

1. Switching on and switching off of system
2. Activation of the RESET UG 6911 operator.

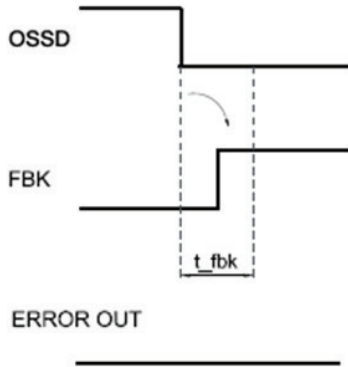

Example of OSSD with correct Feedback signal
In this case ERROR OUT = FALSE

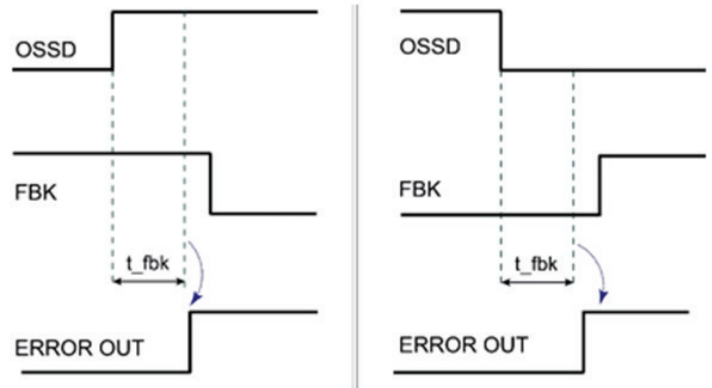

Example of OSSD with incorrect Feedback signal:
(externe Time K überschritten) In this case
ERROR OUT = TRUE

OSSD feedback unconnected:

If selected, the feedback must not be connected.

If not selected the feedback must be connected directly to 24 V or through the series of NC contacts of K1/K2.

 This parameter is only applicable to the module UG 6912.04/100 with firmware version > 0.1.

No test pulses:

If selected it disables the "Voltage-Dip"-Test on the OSSD safety outputs (refer to "Important note concerning OSSD Safety Outputs")

 Selecting "no test pulse" causes the loss of the safety function of the Single-Double OSSD (function block grey colored). As a consequence the SIL will be downgraded.

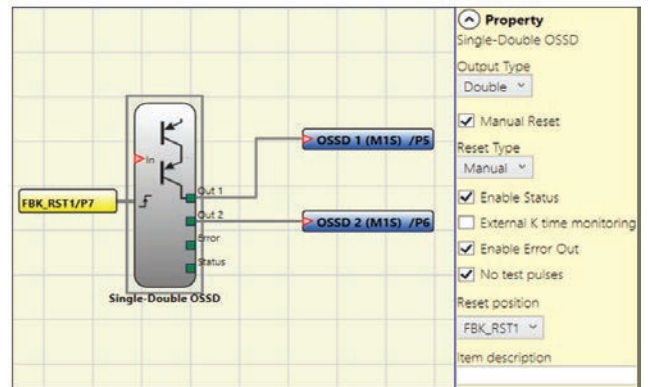

Reset Position:

The modules UG 6911.12/080, (FW vers. ≥ 7.0) and UG 6916.12/080, (FW vers. ≥ 0.3) allow to select the physical terminal of the module to give the reset command. You can also use the same terminal for different OSSD outputs.

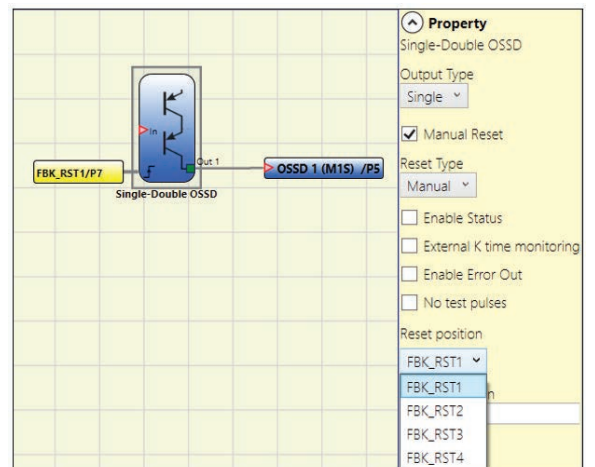

 The unused Feedback/Restart Pins can be used as single inputs in the schematic (UG 6911.12/080, (FW vers. ≥ 7.0), UG 6916.12/080, (FW vers. ≥ 0.3)).

Status (SIL 1 / PL c output)

The STATUS output makes it possible to monitor any point on the diagram by connecting it to the input. The output returns 24VDC if the input is 1 (TRUE), or 0VDC if the input is 0 (FALSE).

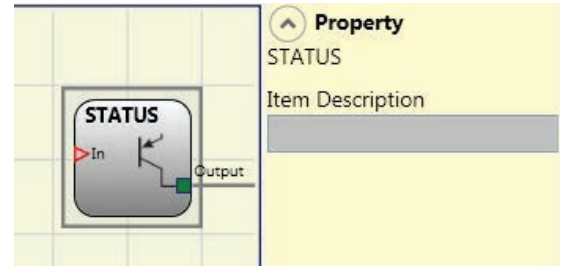

Parameters

Item Description:

This allows a description of the component's function to be entered. The text is displayed in the top part of the symbol



WARNING: The status output only reaches safety level SIL 1 / PL c.

RELAY (safety output)

Relay Outputs are N.O. relay contact. They are closed if the input in is 1(TRUE), otherwise the contact is open (FALSE)

Parameters

Category:

With this selection is it possible to select between 3 different Categories relay output:

Category 1:

Outputs with single Category 1 relay.
Each UG 6914.04 module can have up to 4 of this relay outputs.

Feature:

- Internal relays are monitored.
- EDM feedback (check of FBK 1-4) not used (not requested for Category 1).
- Each output can be set as AUTO or MANUAL RESTART

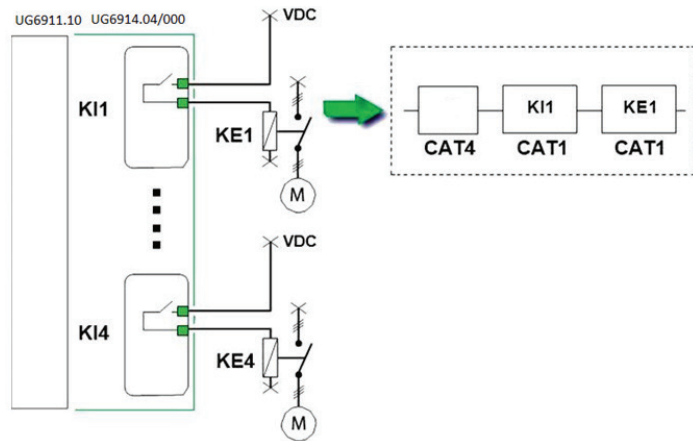
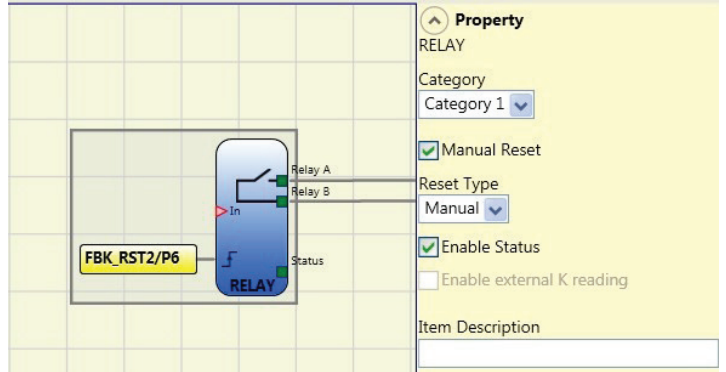

Example with external relay

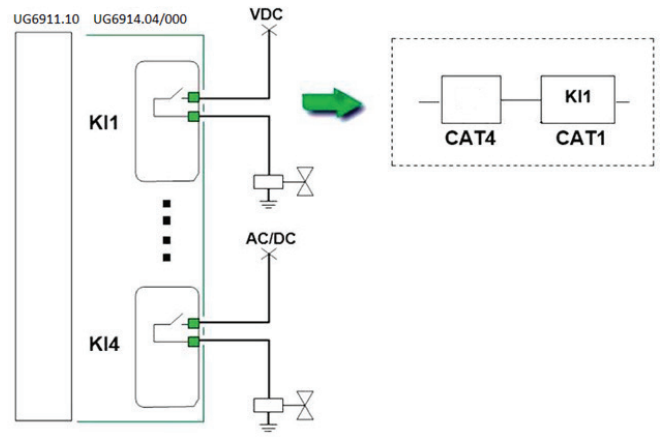

Example with the internal relay only

Category 2:

Outputs with single Category 2 relay with OTE feature.
Each UG6914 module can have up to 4 of this relay outputs.

OTE:

The OTE (Output Test Equipment) output is normally 1 (TRUE) except in the case of an internal error or a fault associated with feedback from the external contactors (FALSE)

Features:

- Internal relays are always monitored.
- Monitored EDM feedback
- The output can be configured to Manual or Automatic restart. The EDM feedback monitor cannot be activated with the Manual restart. To monitor the EDM feedback it must be configured Automatic restart. In this case, if you want to use the Manual restart, a dedicated logic shall be provided. Refer to the following note.

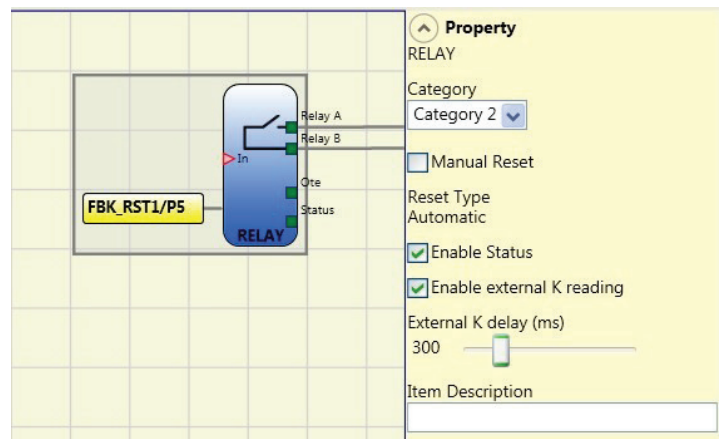

Output Test Equipment

 A OTE (Output Test Equipment) is mandatory with configurations of category 2 in order to report hazardous failures in accordance with EN 13849-1: 2015.

OTE (Output Test Equipment) output:

- ON in normal operation
- OFF in case of an internal error or a fault associated with feedback from the external contact (OFF). This permits to stop dangerous movements or at least signal the fault to the user.

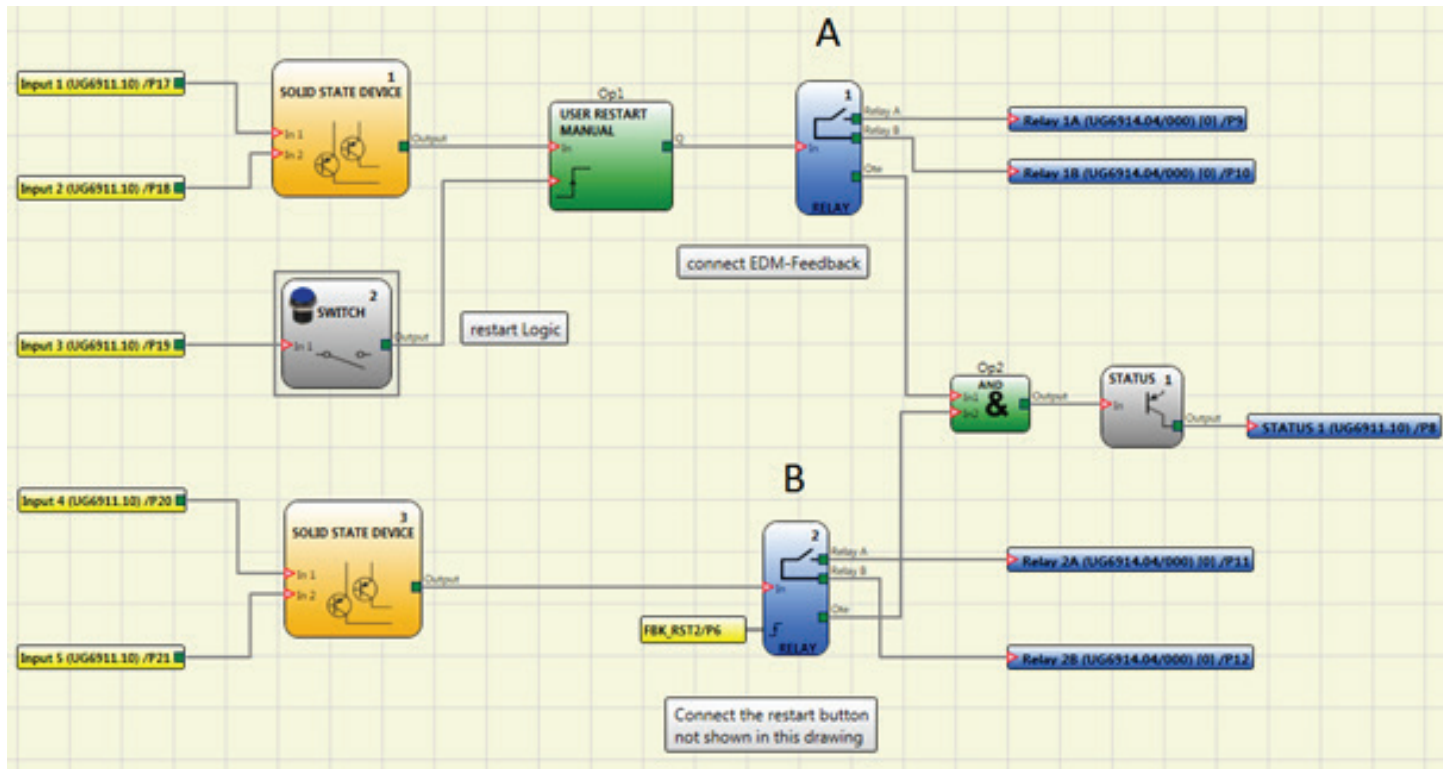

Example for the use of Automatic (A) or Manual (B) Restart of category 2

Parameters

Category 4:

Outputs with two Category 4 relays. Each UG 6914.04 module can have up to 2 of these outputs. With this output the relays are controlled in pairs.

Features:

- 2 double channel outputs
- Double internal relays are monitored.
- Each output can be set as AUTO or MANUAL RESTART

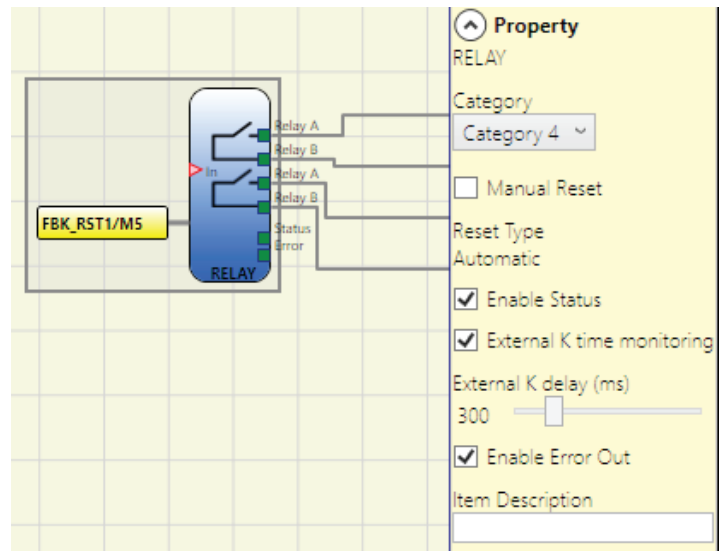

 In order to not affect the outcome of the calculation of the PL, the inputs (sensors or safety devices) must be of a category equal to or higher than the other devices in the chain.

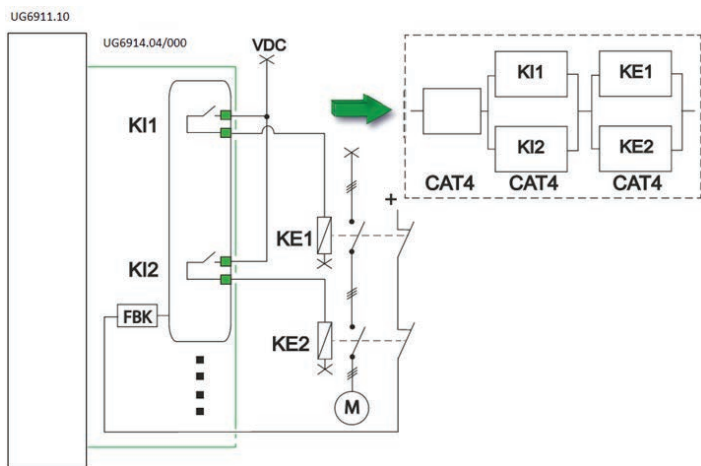

Example of the use with the internal relay only and monitored solenoid valves

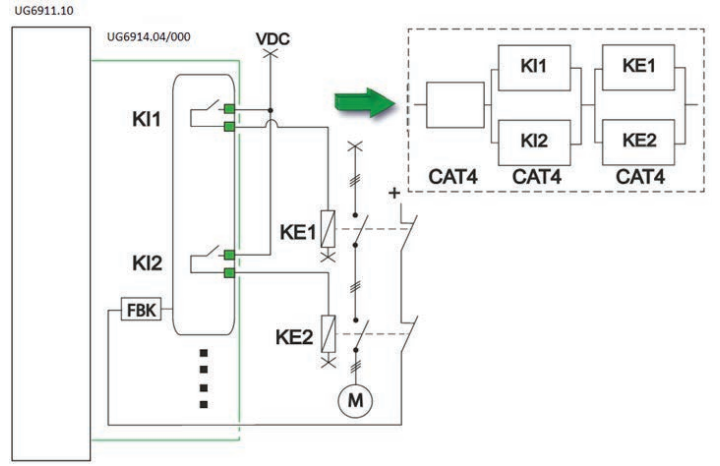

Example of the use with external contactors with feedback

Parameters

Manual Reset:

If selected enables the request to restart each time after the input signal falls. Otherwise, enabling of the output directly follows the input conditions. There are two types of reset: Manual and Monitored. When Manual is selected the system only verifies the signal's transition from 0 to 1. If Monitored is selected the double transition from 0 to 1 and then back to 0 is verified.

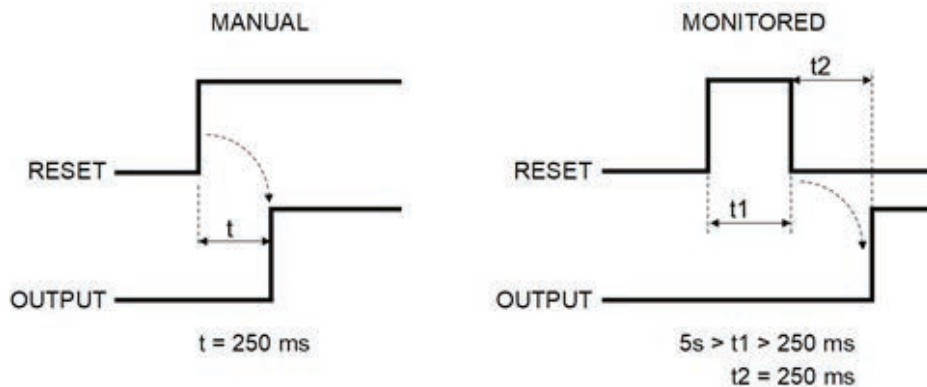

Enable Status:

If selected, the connection of the current relay state to any point on the screen is enabled..

Enable external K reading:

If this is selected it enables the reading and verification of external contactor switching times:

- With Category 1 control of external contactors cannot be enabled.
- With Category 4 control of external contactors is mandatory (always enabled).

External K delay (ms):

Select the maximum delay the external contactors are allowed to introduce. This value can be used to check the maximum delay between switching the internal relays and switching the external contactors (during both activation and deactivation).

Item Description:

This allows a description of the component's function to be entered. The text is displayed in the top part of the symbol.

Enable Error Out:

If selected, enables the ERROR OUT output. This output is set to high level (TRUE) when an external FBK error is detected. The signal is reset in case of one of the following events:

1. Switching on and switching off of system
2. Activation of the RESET UG 6911 operator.

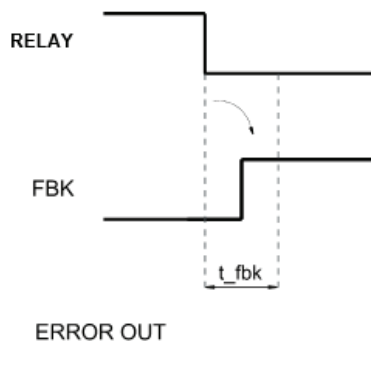

**Example of RELAY with correct Feedback signal:
In this case ERROR OUT=FALSE**

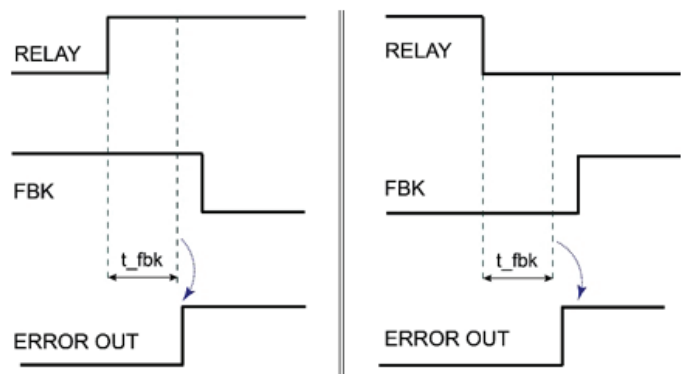

**Example of RELAY with incorrect Feedback signal
(k external time exceeded):
In this case ERROR OUT=TRUE**

Fieldbus Probe

FIELDDBUS PROBES indicate the logical status of any point of the SAFEMASTER PRO schematic. These information are then transmitted over the fieldbus and are represented with 4 bytes (UG 6911.12/080) or 2 bytes (UG 6911.10).

It is possible to insert a maximum of 32 probes with UG 6911.12/080 and 16 probes with UG 6911.10.

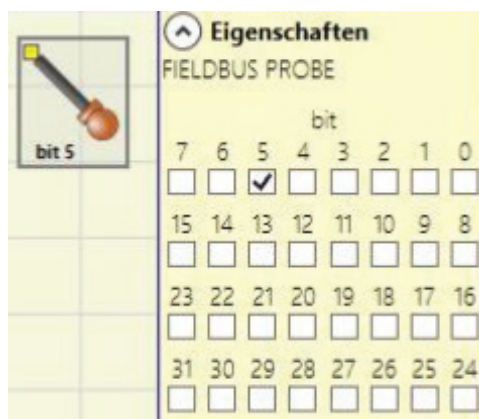

(For more detailed information, consult the fieldbus manual on the SAFEMASTER PRO Designer CD-ROM).



WARNING: The FIELDDBUS PROBE is **NOT** a safety output !

INPUT OBJECTS

E-STOP (emergency stop)

The E-STOP function block verifies the status of the inputs of an emergency stop device. If the emergency stop button has been pressed the output is 0 (FALSE). If not the output is 1 (TRUE).

Parameters

- Input Type:
- Single NC – Allows connection of single channel emergency stop buttons
 - Double NC – Allows connection of dual channel emergency stop buttons

Manual Reset:
If selected this enables the request to reset each time the emergency stop is activated. Otherwise, enabling of the output directly follows the input conditions.

There are two types of reset: Manual and Monitored. When Manual is selected the system only verifies the signal's transition from 0 to 1. If Monitored is selected the double transition from 0 to 1 and then back to 0 is verified

WARNING: If the Manual Reset is active, a consecutive Input has to be used. Example: In 1 and In 2 are used for the functional block, then In 3 has to be used for the Reset Input.

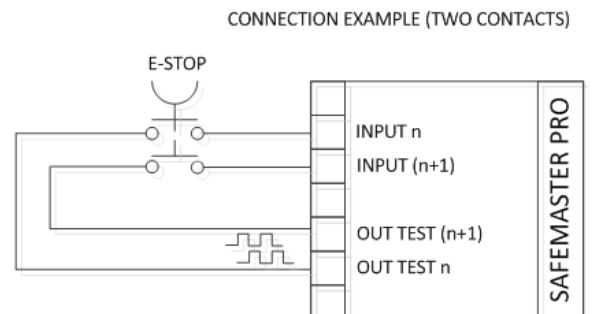
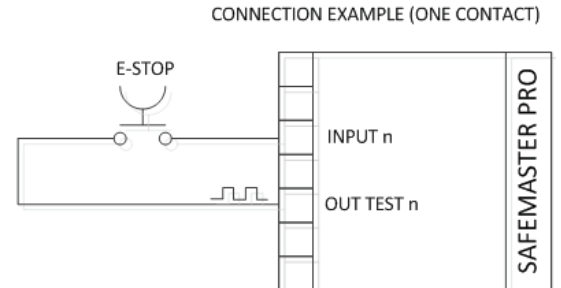
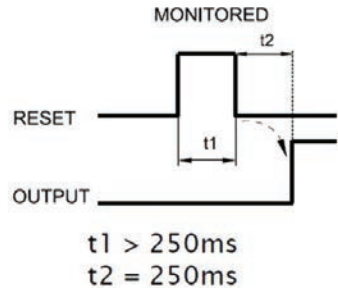
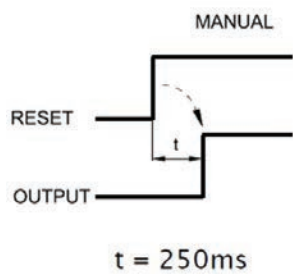
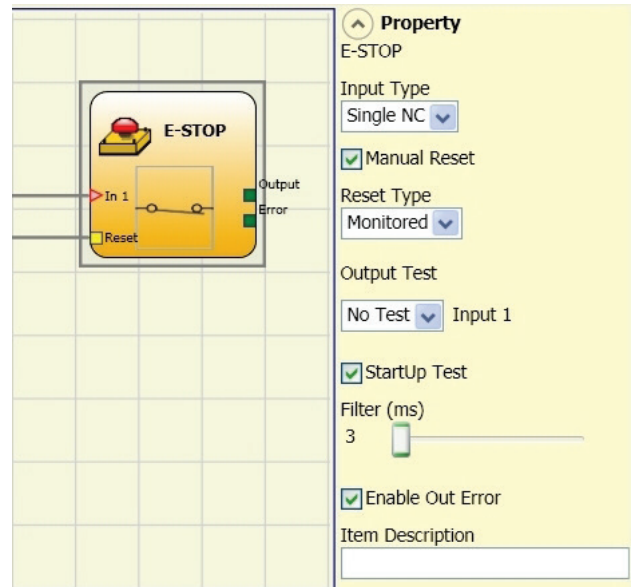

Parameters

Output Test:

This is used to select which test output signals are to be sent to the emergency stop (e-stop button). This additional test makes it possible to detect and manage any short-circuits between the lines. There is a choice of up to 8 possible test output signals, Test Output 1 ÷ Test Output 8 (depending on used module).

Startup Test:

If selected this enables the test at start-up of the external component (emergency stop). This test is performed by pressing and releasing the pushbutton to run a complete function test and enable the output. This test is only requested at machine start-up (when the unit is switched on).

Filter (ms):

This is used to filter the signals coming from the emergency stop. The filter can be configured to between 3 and 250 ms and eliminates any bouncing on the contacts. The length of the filter affects the calculation of the unit's total response time

With Simultaneity:

If selected this activates the test to verify simultaneous switching of the signals coming from the emergency stop.

Simultaneity (ms):

This is only active if the previous parameter is enabled. It defines the maximum time (in ms) between the switching of two different signals from the emergency stop.

Enable Error Out:

If selected reports a fault detected by the function block.

Item Description:

This allows a description of the component's function to be entered. The text is displayed in the top part of the symbol.

E-GATE (safety gate device)

The E-GATE function block verifies the input status of a mobile guard or safety gate device. If the mobile guard or safety gate is open, the output is 0 (FALSE). Otherwise the output is 1 (TRUE).

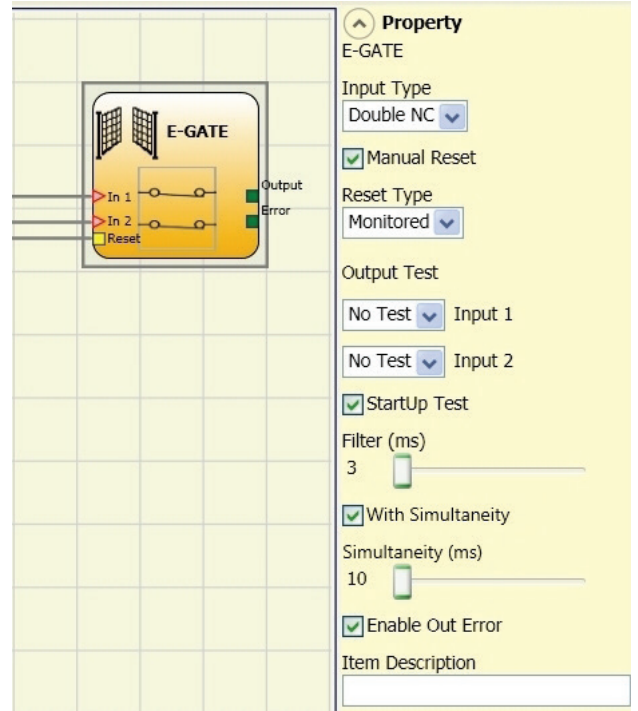

Parameters

Input Type:

- Double NC – Allows connection of components with two NC contacts
- Double NC / NO – Allows connection of components with one NO contact and one NC.

Manual Reset:

If selected this enables the request to reset each time the mobile guard/safety gate is activated. Otherwise, enabling of the output directly follows the input conditions.

Attention: With inactive input (block with Output FALSE), connect as follows:

- Contact NO to terminal corresponding to IN1
- Contact NC to terminal corresponding to IN2.

There are two types of reset:

Manual and Monitored. When Manual is selected the system only verifies the signal's transition from 0 to 1. If Monitored is selected the double transition from 0 to 1 and then back to 0 is verified.

WARNING: If the Manual Reset is active, a consecutive Input has to be used. Example: In 1 and In 2 are used for the functional block, then In 3 has to be used for the Reset Input.

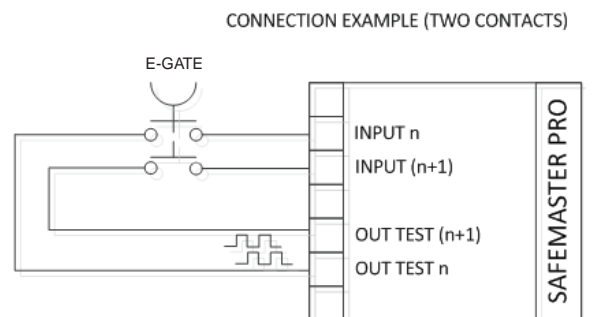
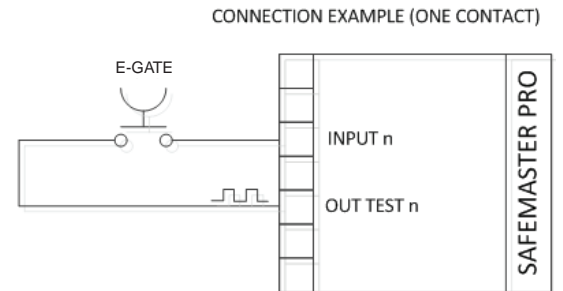
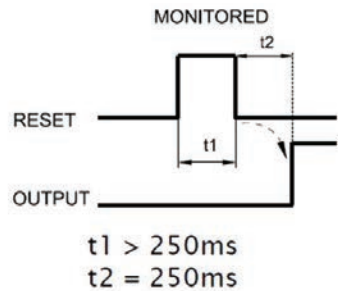
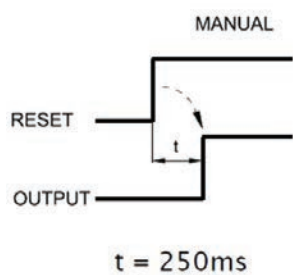

Parameters

Output Test:

This is used to select which test output signals are to be sent to the component contacts. This additional test makes it possible to detect and manage any short-circuits between the lines. There is a choice of up to 8 possible test output signals, Test Output 1 ÷ Test Output 8 (depending on used module).

Startup Test:

If selected this enables the test at start-up of the external component. This test is performed by opening the mobile guard or safety gate to run a complete function test and enable the output. This test is only requested at machine start-up (when the unit is switched on).

Filter (ms):

This is used to filter the signals coming from the external contacts. The filter can be configured to between 3 and 250 ms and eliminates any bouncing on the contacts. The length of the filter affects the calculation of the unit's total response time.

With Simultaneity:

If selected this activates the test to verify simultaneous switching of the signals coming from the external contacts.

Simultaneity (ms):

This is only active if the previous parameter is enabled. It defines the maximum time (in ms) between the switching of two different signals from the external contacts.

Item Description:

This allows a description of the component's function to be entered. The text is displayed in the top part of the symbol.

Enable Error Out:

If selected reports a fault detected by the function block.

Item Description:

This allows a description of the component's function to be entered. The text is displayed in the top part of the symbol.

SINGLE E-GATE (safety gate device)

SINGLE E-GATE function block verifies a mobile guard or safety gate device input status. If the mobile guard or safety gate is open, the output is 0 (FALSE). Otherwise the output is 1 (TRUE).

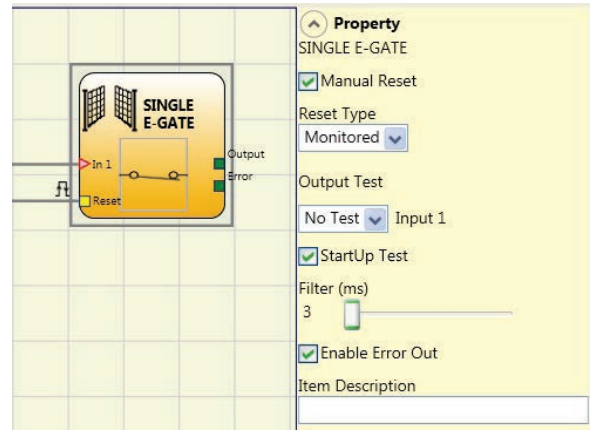

Parameters

Manual Reset:

If selected this enables the request to reset each time the mobile guard/safety gate is activated. Otherwise, enabling of the output directly follows the input conditions.

There are two types of reset:

Manual and Monitored. When Manual is selected the system only verifies the signal's transition from 0 to 1. If Monitored is selected the double transition from 0 to 1 and then back to 0 is verified.

WARNING: If the Manual Reset is active, a consecutive Input has to be used. Example: In 1 and In 2 are used for the functional block, then In 3 has to be used for the Reset Input.

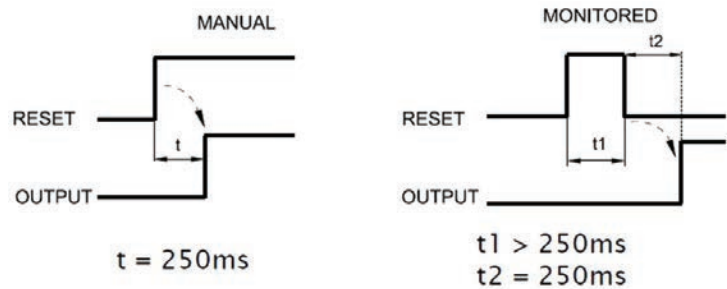

Output Test:

This is used to select which test output signals are to be sent to the component contacts. This additional control permits detection and management of any short-circuits between the lines. To enable this control, the test output signals must be configured (amongst those available).

Startup Test:

If selected this enables the test at start-up of the external component. This test is performed by opening the mobile guard or safety gate to run a complete function test and enable the output. This test is only requested at machine start-up (when the unit is switched on).

Filter (ms):

This is used to filter the signals coming from the external contacts. The filter can be configured to between 3 and 250 ms and eliminates any bouncing on the contacts. The length of the filter affects the calculation of the unit's total response time

Enable Error Out:

If selected reports a fault detected by the function block.

Item Description:

This allows a description of the component's function to be entered. The text is displayed in the top part of the symbol

LOCK FEEDBACK

The function block LOCK FEEDBACK verifies the lock status of a guard lock device for mobile guard or safety gate. In the case where the inputs indicate that the guard is locked the Output will be 1 (TRUE). Otherwise the output is 0 (FALSE).

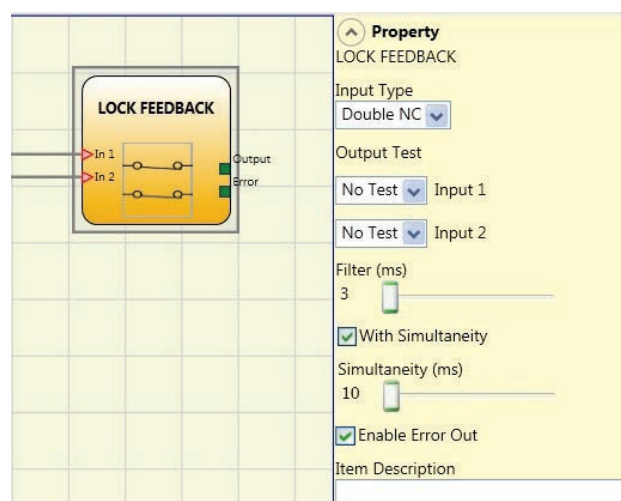
**Parameters****Input Type:**

- Single NC – Allows connection of components with one NO contact
- Double NC – Allows connection of components with two NC contacts.
- Double NC-NO – Allows connection of components with one NO contact and one NC.

**Attention: With inactive input (guard locking unlocked, block with Output FALSE), connect as follows:**

- Contact NO to terminal corresponding to IN1.
- Contact NC to terminal corresponding to IN2

Output Test:

This is used to select which test output signals are to be sent to the component contacts. This additional control permits detection and management of any short-circuits between the lines. To enable this control, the test output signals must be configured (amongst those available).

Filter (ms):

This is used to filter the signals coming from the external contacts. The filter can be configured to between 3 and 250 ms and eliminates any bouncing on the contacts. The length of the filter affects the calculation of the unit's total response time.

With Simultaneity:

If selected this activates the test to verify concurrent switching of the signals coming from the external contacts.

Simultaneity (ms):

This is only active if the previous parameter is enabled. It defines the maximum time (in ms) between the switching of two different signals from the external contacts.

Enable Error Out:

If selected reports a fault detected by the function block.

Item Description:

This allows a description of the component's function to be entered. The text is displayed in the top part of the symbol.

ENABLE (enable key)

The ENABLE function block verifies the status of the inputs of a manual key device. If the key is not turned the output is 0 (FALSE). Otherwise the output is 1 (TRUE).

Parameters

Input Type:

- Single NO – Allows connection of components with two NO contacts
- Double NO – Allows connection of components with two NO contacts.

Manual Reset:

If selected this enables the request to reset each time the command is activated. Otherwise, enabling of the output directly follows the input conditions.

There are two types of reset: Manual and Monitored.

When Manual is selected the system only verifies the signal's transition from 0 to 1. If Monitored is selected the double transition from 0 to 1 and then back to 0 is verified.

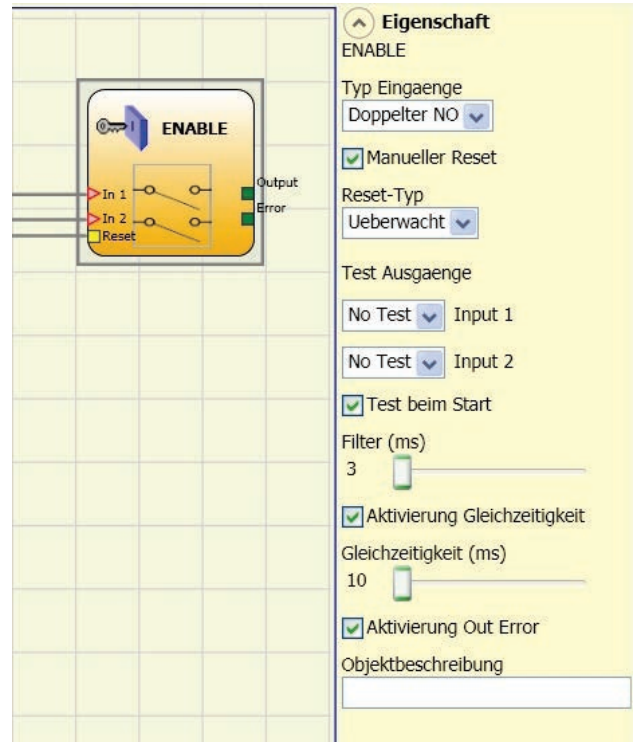

WARNING: If the Manual Reset is active, a consecutive Input has to be used. Example: In 1 and In 2 are used for the functional block, then In 3 has to be used for the Reset Input.

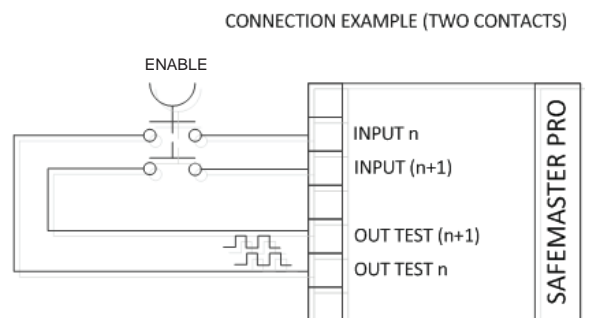
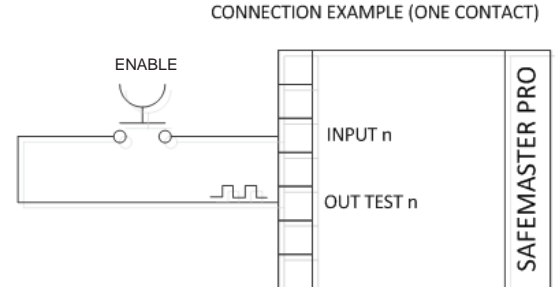
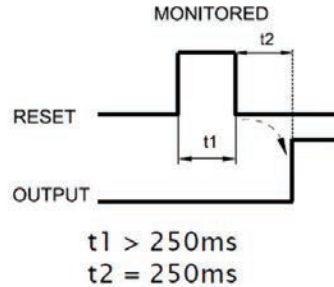
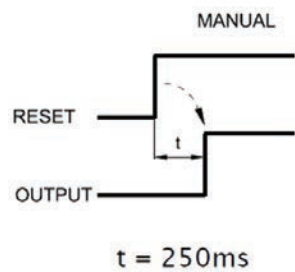

Output Test:

This is used to select which test output signals are to be sent to the component contacts. This additional test makes it possible to detect and manage any short-circuits between the lines. There is a choice of up to 8 possible test output signals, Test Output 1 ÷ Test Output 8 (depending on used module).

Startup Test:

If selected this enables the test at start-up of the external component. This test is performed by opening and closing the contacts of the ENABLE-Switch to run a complete function test and enable the output. This test is only requested at machine start-up (when the unit is switched on).

Filter (ms):

This is used to filter the signals coming from the external contacts. The filter can be configured to between 3 and 250 ms and eliminates any bouncing on the contacts. The length of the filter affects the calculation of the unit's total response time.

With Simultaneity:

If selected this activates the test to verify simultaneous switching of the signals coming from the external contacts.

Simultaneity (ms):

This is only active if the previous parameter is enabled. It defines the maximum time (in ms) between the switching of two different signals from the external contacts.

Enable Error Out:

If selected reports a fault detected by the function block.

Item Description:

This allows a description of the component's function to be entered. The text is displayed in the top part of the symbol.

ESPE (optoelectronic safety light curtain / laser scanner)

The ESPE function block verifies the state of the inputs of an optoelectronic safety light curtain (or laser scanner). If the area protected by the light curtain is occupied, (light curtain outputs FALSE) the output is 0 (FALSE). Otherwise, with the area clear and outputs to 1 (TRUE) the output is 1 (TRUE).

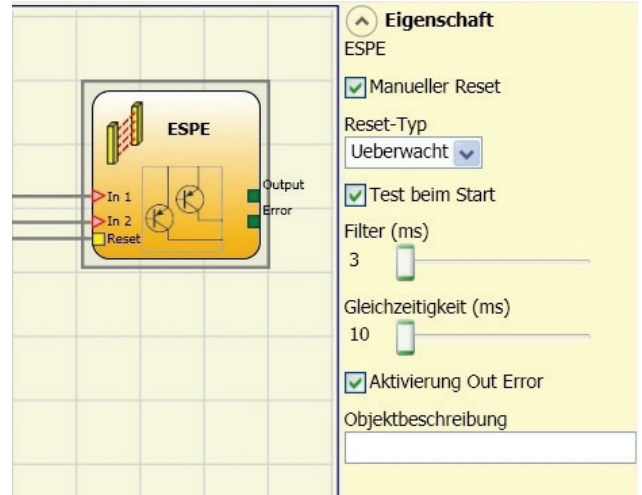

Parameters

Manual Reset:

If selected this enables the request to reset each time the area protected by the safety light curtain is occupied. Otherwise, enabling of the output directly follows the input conditions.

There are two types of reset:

Manual and Monitored. When Manual is selected the system only verifies the signal's transition from 0 to 1. If Monitored is selected the double transition from 0 to 1 and then back to 0 is verified.

 **WARNING:** If the Manual Reset is active, a consecutive Input has to be used. Example: In 1 and In 2 are used for the functional block, then In 3 has to be used for the Reset Input.

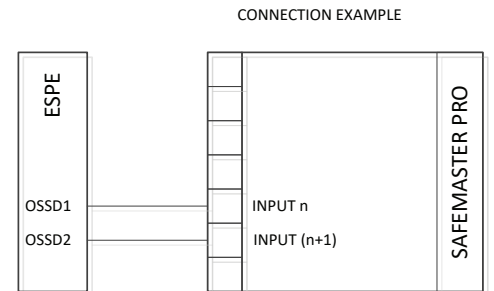
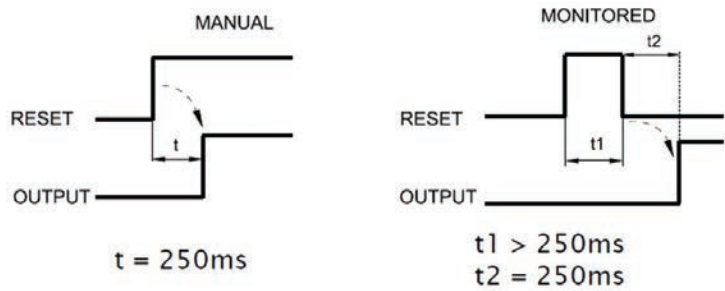

Startup Test:

If selected this enables the test at start-up of the safety light curtain. This test is performed by occupying and clearing the area protected by the safety light curtain to run a complete function test and enable the output. This test is only requested at machine start-up (when the unit is switched on).

Filter (ms):

This is used to filter the signals coming from the safety light curtain. The filter can be configured to between 3 and 250 ms and eliminates any bouncing on the contacts. The length of the filter affects the calculation of the unit's total response time

Simultaneity (ms)

This is only active if the previous parameter is enabled. It defines the maximum time (in msec) between the switching of two different signals from the safety light curtain.

Enable Error Out:

If selected reports a fault detected by the function block.

Item Description:

This allows a description of the component's function to be entered. The text is displayed in the top part of the symbol.

FOOTSWITCH (safety pedal)

The FOOTSWITCH function block verifies the status of the inputs of a safety pedal device. If the pedal is not pressed the output is 0 (FALSE). Otherwise the output is 1 (TRUE).

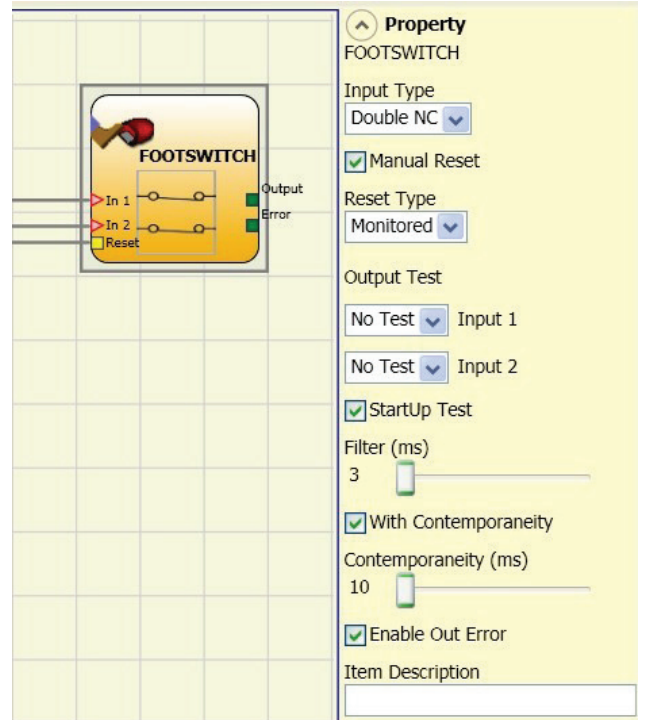

Parameters

Input Type:

- Single NC – Allows connection of pedals with one NC contact
- Single NO – Allows connection of pedals with one NO contact
- Double NC – Allows connection of pedals with two NC contacts
- Double NC/NO – Allows connection of pedals with one NO contact and one NC.

Manual Reset:

If selected this enables the request to reset each time the footswitch is activated. Otherwise, enabling of the output directly follows the input conditions.

There are two types of reset: Manual and Monitored.

When Manual is selected the system only verifies the signal's transition from 0 to 1. If Monitored is selected the double transition from 0 to 1 and then back to 0 is verified.

 **WARNING:** If the Manual Reset is active, a consecutive Input has to be used. Example: In 1 and In 2 are used for the functional block, then In 3 has to be used for the Reset Input.

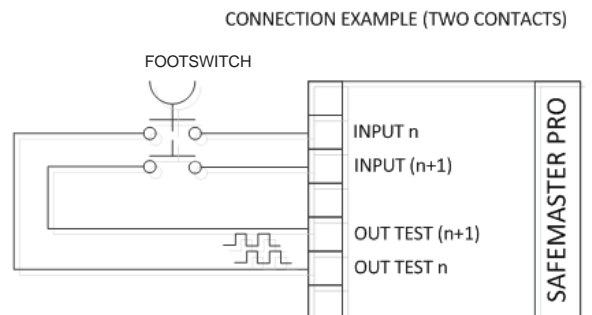
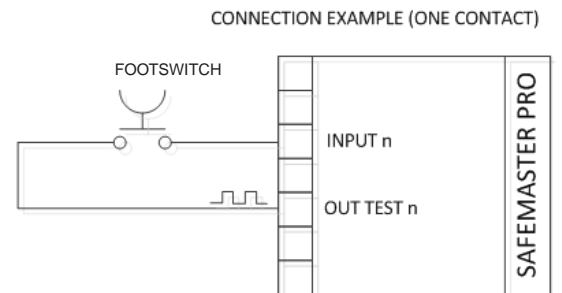
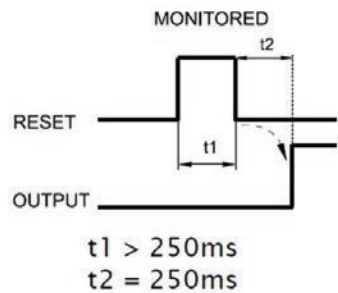
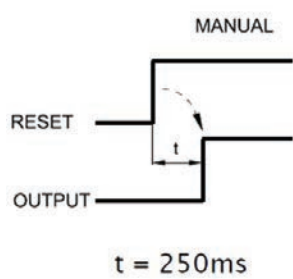

Parameters

Output Test:

This is used to select which test output signals are to be sent to the component contacts. This additional test makes it possible to detect and manage any short-circuits between the lines. There is a choice of up to 8 possible test output signals, Test Output 1 ÷ Test Output 8 (depending on used module).

Startup Test:

If selected this enables the test at start-up of the external component. This test is performed by pressing the pedal to run a complete function test and enable the output. This test is only requested at machine start-up (when the unit is switched on).

Filter (ms):

This is used to filter the signals coming from the external contacts. The filter can be configured to between 3 and 250 ms and eliminates any bouncing on the contacts. The length of the filter affects the calculation of the unit's total response time.

With Simultaneity:

At der Aktivierung dieser Funktion wird die Simultaneity zweier vom Fußschalter kommenden Signale überwacht.

Simultaneity (ms)

If selected this activates the test to verify simultaneous switching of the signals coming from the external contacts

Enable Error Out:

If selected reports a fault detected by the function block.

Item Description:

This allows a description of the component's function to be entered. The text is displayed in the top part of the symbol.

MOD-SEL (safety selector)

The MOD-SEL function block verifies the status of the inputs from a mode selector (up to 4 inputs):

If only one input is 1 (TRUE) the corresponding output is also 1 (TRUE). In all other cases, and thus when all inputs are 0 (FALSE) or more than one input is 1 (TRUE) all the outputs are 0 (FALSE).

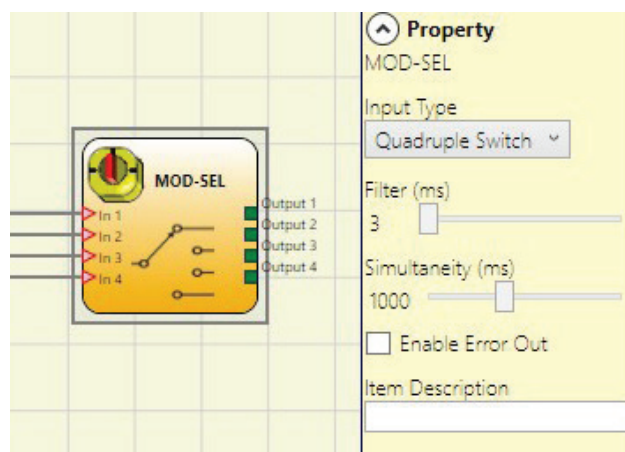
**Parameters**

Input Type:

- Double selector – Allows connection of two-way mode selectors
- Triple selector – Allows connection of three-way mode selectors
- Quadruple selector – Allows connection of four-way mode selectors.

Filter (ms):

This is used to filter the signals coming from the mode selector. The filter can be configured to between 3 and 250 ms and eliminates any bouncing on the contacts. The length of the filter affects the calculation of the unit's total response time.

Simultaneity (ms):

Always active. Determines the maximum permissible time (ms) between switching of the various signals from the external contacts of the device.

Enable Error Out:

If selected reports a fault detected by the function block.

Item Description:

This allows a description of the component's function to be entered. The text is displayed in the top part of the symbol.

PHOTOCELL (safety photocell)

The PHOTOCELL function block verifies the status of the inputs of an optoelectronic safety photocell. If the beam of the photocell is occupied (photocell output FALSE) the output is 0 (FALSE). Otherwise with the beam clear and an output of 1 (TRUE) the output is 1 (TRUE).

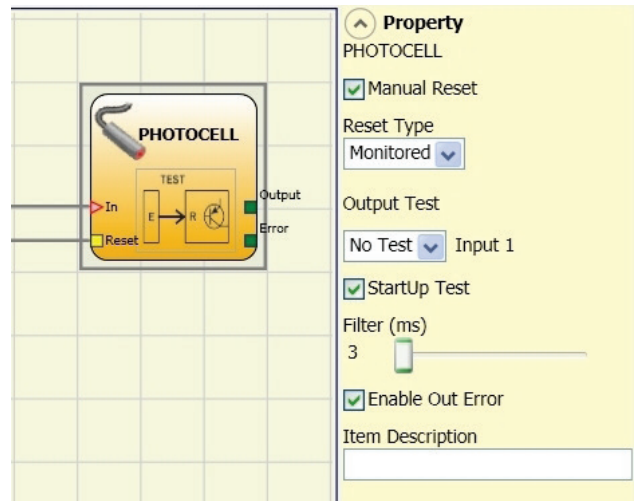

Parameters

Manual Reset:

If selected this enables the request to reset each time the safety photocell is activated. Otherwise, enabling of the output directly follows the input conditions.

There are two types of reset: Manual and Monitored.

When Manual is selected the system only verifies the signal's transition from 0 to 1. If Monitored is selected the double transition from 0 to 1 and then back to 0 is verified.

 **WARNING:** If the Manual Reset is active, a consecutive Input has to be used. Example: In 1 and In 2 are used for the functional block, then In 3 has to be used for the Reset Input.

 An output test signal is mandatory and can be selected from the 4 possible Test Output 1 - 4.

 The response time of the photocell must be > 2 ms and < 20 ms.

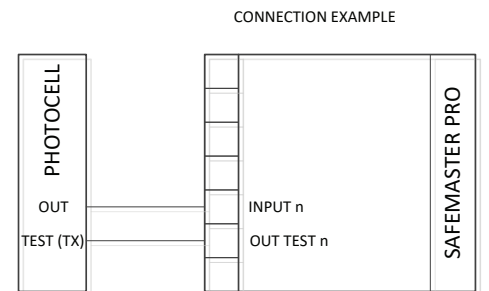
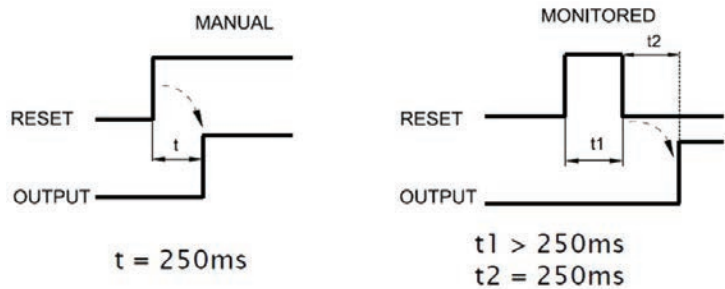

Output Test:

This is used to select which test output are to be sent to the photocell test input. This additional test makes it possible to detect and manage any short-circuits between the lines. One test signal is mandatory. There is a choice of up to 8 possible test output signals, Test Output 1 ÷ Test Output 8 (depending on used module).

Startup Test:

If selected this enables the test at start-up of the external component. This test is performed by occupying and clearing the light stream of the safety photocell to run a complete function test and enable the output. This test is only requested at machine start-up (when the unit is switched on).

Filter (ms):

This is used to filter the signals coming from the external contacts. The filter can be configured to between 3 and 250 ms and eliminates any bouncing on the contacts. The length of the filter affects the calculation of the unit's total response time

Enable Error Out:

If selected reports a fault detected by the function block.

Item Description:

This allows a description of the component's function to be entered. The text is displayed in the top part of the symbol.

TWO-HAND (bimanual control)

The TWO HAND function block verifies the status of the inputs of a two hand control switch. Only if both the press-buttons are pressed within 500msec the output is 1 (TRUE). Otherwise the output is 0 (FALSE).

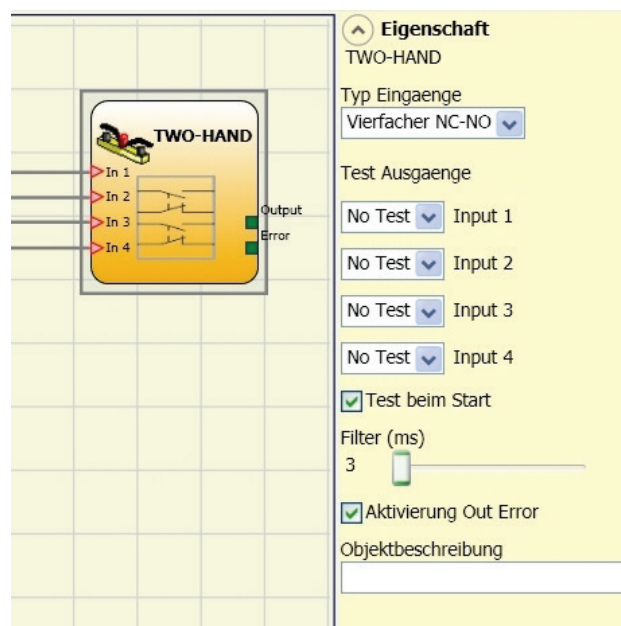
**Parameters**

Input Type:

- Double NO – Allows connection of two-hand switch with one NO contact for each button
- Double NO-NC – Allows connection of two-hand switch with a double NO/NC contact for each button

Attention: With inactive input (block with Output FALSE), connect as follows:

- Contact NO to terminal corresponding to IN1
- Contact NC to terminal corresponding to IN2

Output Test:

This is used to select which test output signals are to be sent to the component contacts. This additional test makes it possible to detect and manage any short-circuits between the lines. There is a choice of up to 8 possible test output signals, Test Output 1 ÷ Test Output 8 (depending on used module).

Startup Test:

If selected this enables the test at start-up of the external component. If this test is enabled, the two buttons must be released before they can be pressed (within 500msec) to run a complete function test and enable the output. This test is only requested at machine start-up (when the unit is switched on).

Filter (ms):

This is used to filter the signals coming from the mode selector. The filter can be configured to between 3 and 250 ms and eliminates any bouncing on the contacts. The length of the filter affects the calculation of the unit's total response time.

Enable Error Out:

If selected reports a fault detected by the function block.

Item Description:

This allows a description of the component's function to be entered. The text is displayed in the top part of the symbol.

SENSOR

The SENSOR function block verifies the status of the input of a sensor (not a safety sensor). If the beam of the sensor is occupied (sensor output FALSE) the output is 0 (FALSE). Otherwise, with the beam clear and an output of 1 (TRUE) then the output is 1 (TRUE)

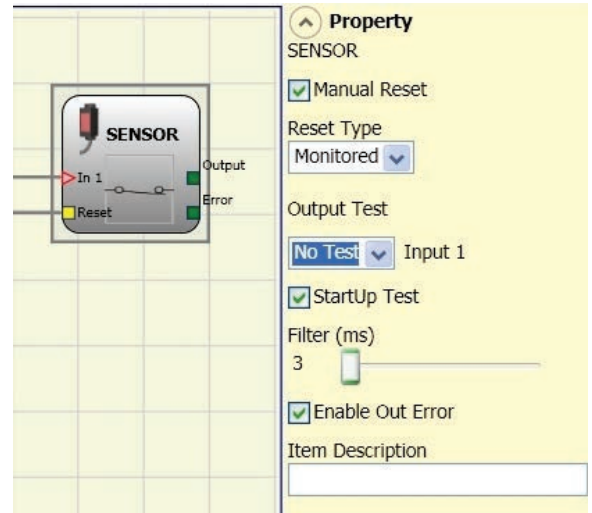

Parameters

Manual Reset:

If selected this enables the request to reset each time the area protected by the sensor is occupied. Otherwise, enabling of the output directly follows the input conditions.

There are two types of reset: Manual and Monitored.

When Manual is selected the system only verifies the signal's transition from 0 to 1. If Monitored is selected the double transition from 0 to 1 and then back to 0 is verified.

WARNING: If the Manual Reset is active, a consecutive Input has to be used. Example: In 1 and In 2 are used for the functional block, then In 3 has to be used for the Reset Input.

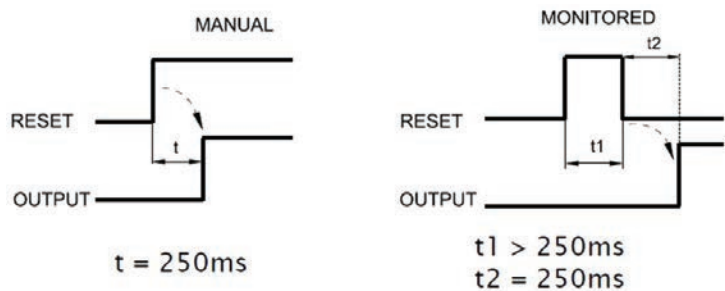

Output Test:

This is used to select which test output signals are to be sent to the sensor. This additional test makes it possible to detect and manage any short-circuits between the lines. There is a choice of up to 8 possible test output signals, Test Output 1 ÷ Test Output 8 (depending on used module).

Startup Test:

If selected this enables the test at start-up of the external component. This test is performed by occupying and clearing the area of the sensor to run a complete function test and enable the output. This test is only requested at machine start-up (when the unit is switched on).

Filter (ms):

This is used to filter the signals coming from the safety light curtain. The filter can be configured to between 3 and 250 ms and eliminates any bouncing on the contacts. The length of the filter affects the calculation of the unit's total response time

Enable Error Out:

If selected reports a fault detected by the function block.

Item Description:

This allows a description of the component's function to be entered. The text is displayed in the top part of the symbol.

S-MAT (safety mat)

The S-MAT function block verifies the status of the inputs of a safety mat. If a person stands on the mat the output is 0 (FALSE). Otherwise, with the mat clear, the output is 1 (TRUE).

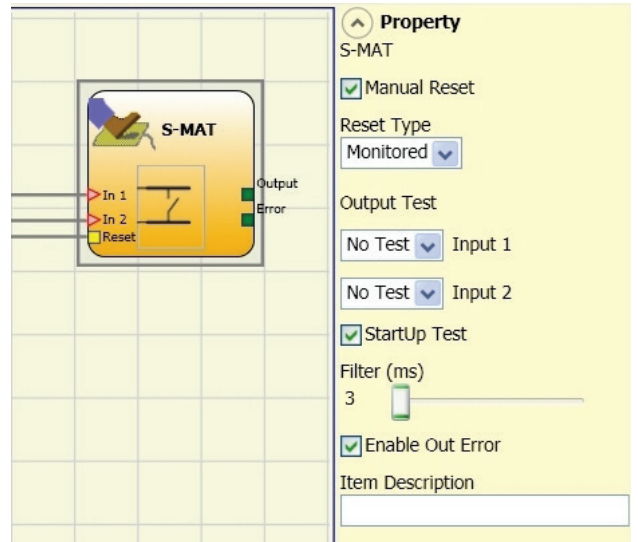

Parameters

Manual Reset:

If selected this enables the request to reset each time the safety mat is activated. Otherwise, enabling of the output directly follows the input conditions.

There are two types of reset: Manual and Monitored.

When Manual is selected the system only verifies the signal's transition from 0 to 1. If Monitored is selected the double transition from 0 to 1 and then back to 0 is verified.

WARNING: If the Manual Reset is active, a consecutive Input has to be used. Example: In 1 and In 2 are used for the functional block, then In 3 has to be used for the Reset Input.

Two output test signals are mandatory. Each output OUT TEST can be connected to only one input S-MAT (It is not allowed parallel connection of 2 inputs).

The function block S-MAT cannot be used with 2-wire components and termination resistance.

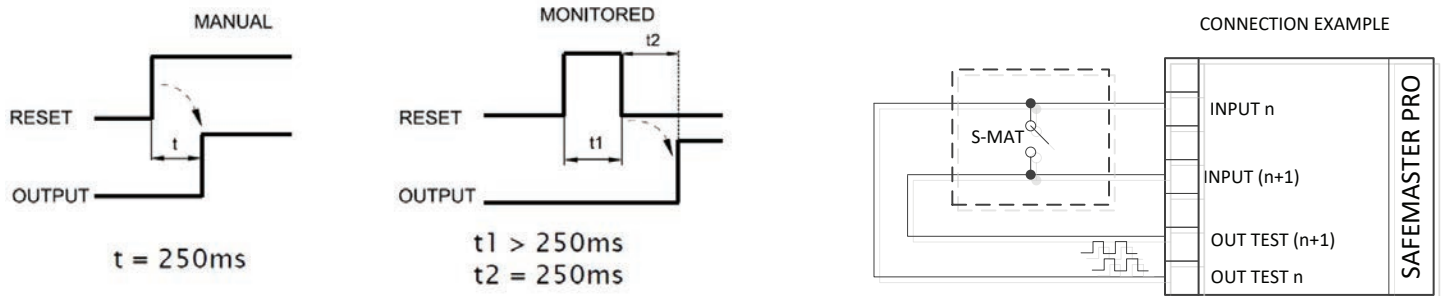

Output Test:

Test signals are mandatory. There is a choice of up to 8 possible test output signals, Test Output 1 ÷ Test Output 8 (depending on used module).

Startup Test:

If selected this enables the test at start-up of the external component. This test is performed by standing on the S-Mat to run a complete function test and enable the output. This test is only requested at machine start-up (when the unit is switched on).

Filter (ms):

This is used to filter the signals coming from the external contacts. The filter can be configured to between 3 and 250 ms and eliminates any bouncing on the contacts. The length of the filter affects the calculation of the unit's total response time.

Enable Error Out:

If selected reports a fault detected by the function block.

Item Description:

This allows a description of the component's function to be entered. The text is displayed in the top part of the symbol.

SWITCH (Schalter)

The SWITCH function block verifies the status of the input of a pushbutton or switch (not safety switches). If the pushbutton is pressed the output is 1 (TRUE). Otherwise, the output is 0 (FALSE).

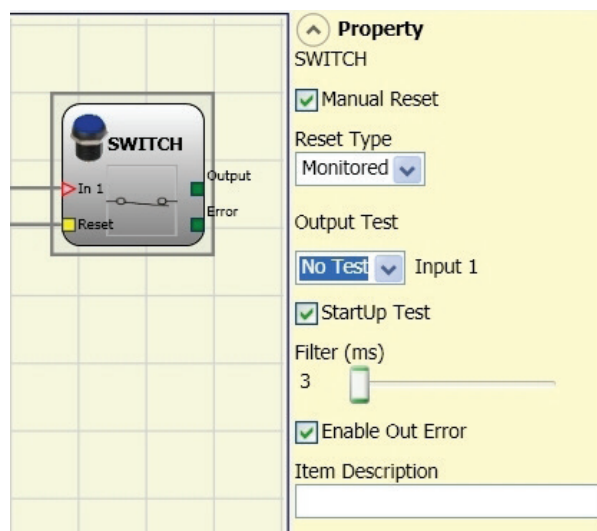

Parameters

Manual Reset:

If selected this enables the request to reset each time the switch is closed. Otherwise, enabling of the output directly follows the input conditions.

There are two types of reset: Manual and Monitored.

When Manual is selected the system only verifies the signal's transition from 0 to 1. If Monitored is selected the double transition from 0 to 1 and then back to 0 is verified.

WARNING: If the Manual Reset is active, a consecutive Input has to be used. Example: In 1 and In 2 are used for the functional block, then In 3 has to be used for the Reset Input.

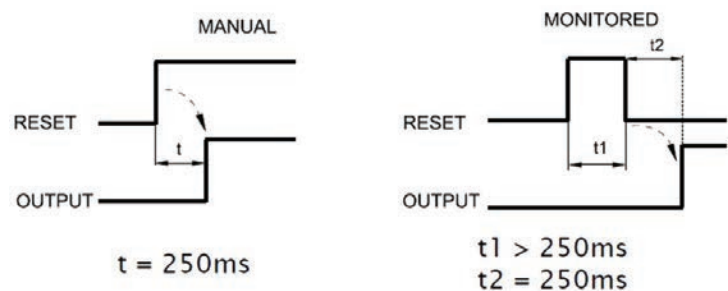

Output Test:

This is used to select which test output signals are to be sent to the emergency stop (mushroom pushbutton). This additional test makes it possible to detect and manage any short-circuits between the lines. There is a choice of up to 8 possible test output signals, Test Output 1 ÷ Test Output 8 (depending on used module).

Startup Test:

If selected this enables the test at start-up of the external component. This test is performed by release the switch before it can be pressed to run a complete function test and enable the output. This test is only requested at machine start-up (when the unit is switched on).

Filter (ms):

This is used to filter the signals coming from the safety light curtain. The filter can be configured to between 3 and 250 ms and eliminates any bouncing on the contacts. The length of the filter affects the calculation of the unit's total response time.

Enable Error Out:

If selected reports a fault detected by the function block.

Item Description:

This allows a description of the component's function to be entered. The text is displayed in the top part of the symbol.

ENABLING GRIP SWITCH

The ENABLING GRIP functional block checks the status of the Inx inputs of an enabling grip. If this is not gripped (position 1) or is gripped completely (position 3), the OUTPUT will be 0 (FALSE). If it is gripped to middle position (position 2), the OUTPUT will be 1 (TRUE).

Refer to truth tables at the bottom of the page.

Note: The ENABLING GRIP functional block requires that the assigned module has a minimum Firmware version as Table below:

UG 6911	UG 6916	UG 6913.08	UG 6913.16	UG 6913.12
1.0	0.4	0.4	0.4	0.0

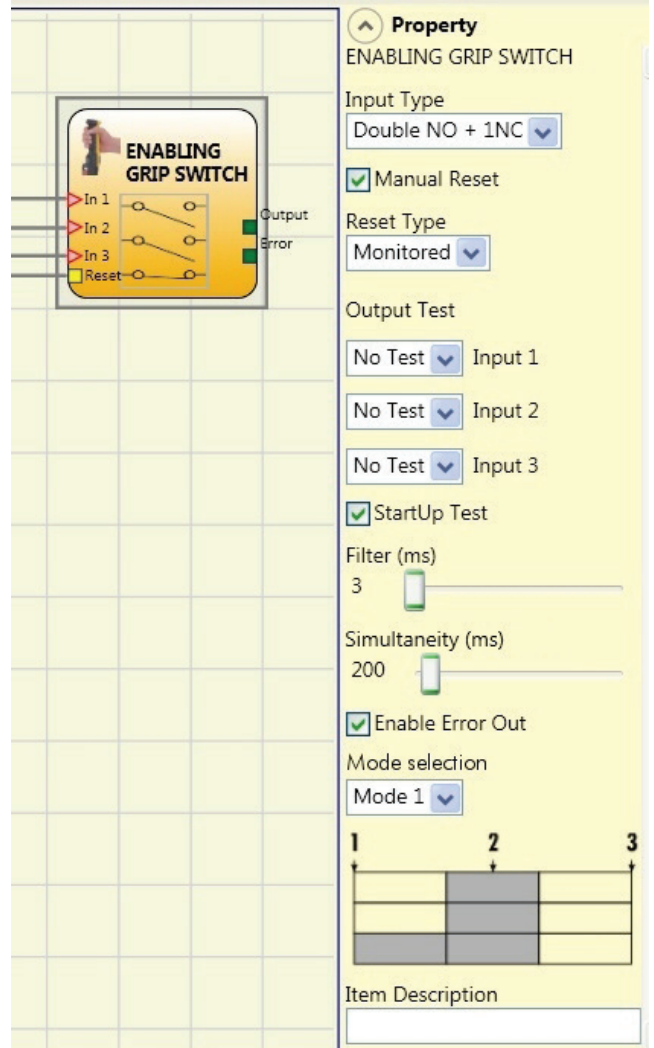

Parameters

Input Type:

- Double NO:
Permits connection of an enabling grip with 2 NO contacts
- Double NO + 1 NC:
Permits connection of an enabling grip switch with 2 NO contacts + 1 NC contact

Manual Reset:

If selected, enables the reset request after each activation of the device. Otherwise, enabling of the output follows directly the conditions of the inputs.

Reset may be of two types: Manual and Monitored. Selecting the Manual option, only transition of the signal from 0 to 1 is checked. If Monitored is selected, double transition from 0 to 1 and return to 0 is checked.

There are two types of reset:

Manual and Monitored.

When Manual is selected the system only verifies the signal's transition from 0 to 1. If Monitored is selected the double transition from 0 to 1 and then back to 0 is verified.

WARNING: If the Manual Reset is active, a consecutive Input has to be used. Example: In 1 and In 2 are used for the functional block, then In 3 has to be used for the Reset Input.

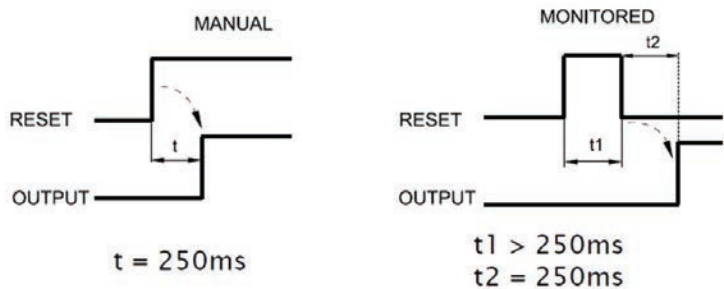

Parameters

Output Test:

Permits selection of the test output signals to be sent to the enabling grip.
This additional control permits detection and management of any short-circuits between the lines. To enable this control, the test output signals must be configured (amongst those available).

Startup Test:

If selected, enables the power-on test of the external component (Enabling Grip). To run the test, the device must be gripped and released to carry out a complete functional check and enable the Output terminal. This control is required only at machine start-up (power-on of the module).

Simultaneity (ms):

Always active. Determines that maximum permissible time (msec) between switching of the various signals from the external contacts of the device

Filter (ms):

Permits filtering of signals from the device control. This filter can be set to between 3 and 250 ms and eliminates any rebounds on the contacts. The duration of the filter affects calculation of module total response time

Enable Error Out:

If selected reports a fault detected by the function block.

Item Description:

This allows a description of the component's function to be entered. The text is displayed in the top part of the symbol.

Table Mode 1 (device 2 NO + 1 NC)

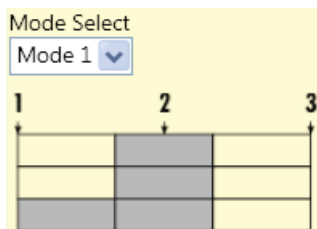

POSITION 1: Enabling grip fully released
POSITION 2: Enabling grip pressed to middle position
POSITION 3: Enabling grip fully pressed

(only with 2 NO+1 NC)

Input	Position		
	1	2	3
In 1	0	1	0
In 2	0	1	0
In 3	1	1	0
Output	0	1	0

Table Mode 2 (device 2 NO + 1 NC)

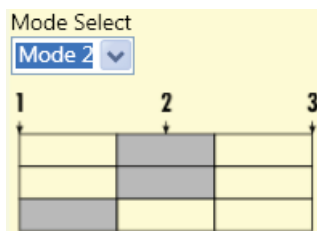

POSITION 1: Enabling grip fully released
POSITION 2: Enabling grip pressed to middle position
POSITION 3: Enabling grip fully pressed

(only with 2 NO+1 NC)

Input	Position		
	1	2	3
In 1	0	1	0
In 2	0	1	0
In 3	1	0	0
Output	0	1	0

TESTABLE SAFETY DEVICE

The TESTABLE SAFETY DEVICE functional block checks the status of the Inx inputs of a single or double safety sensor, both NO and NC. Refer to the tables below to check type of sensor and behavior.

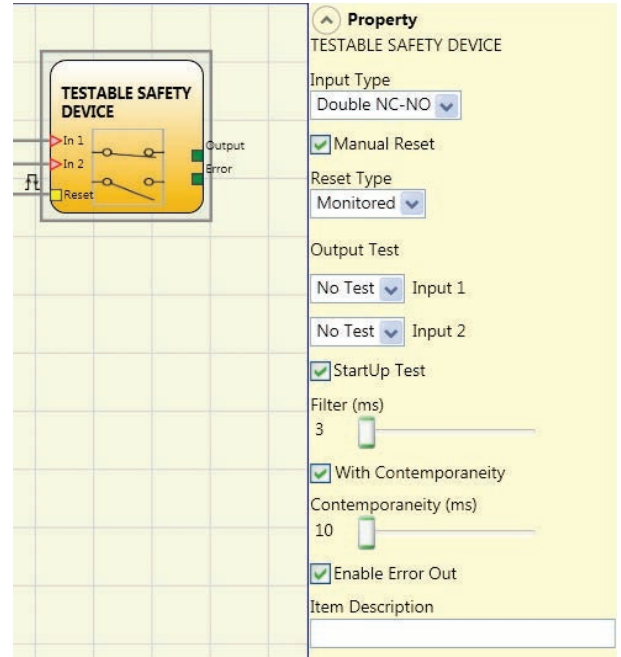

Parameters

Input Type:

- Refer to the tables below to check type of sensor and behaviour

Manual Reset:

If selected, enables the reset request after each activation of the device. Otherwise, enabling of the output follows directly the conditions of the inputs.

There are two types of reset:

Manual and Monitored.

Selecting the Manual option, only transition of the signal from 0 to 1 is checked. If Monitored is selected, double transition from 0 to 1 and return to 0 is checked.

(Single NC)



In 1	Output
0	0
1	1

(Single NO)

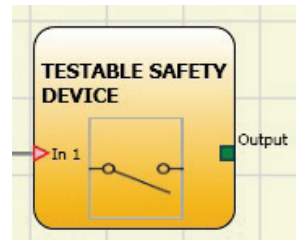

In 1	Output
0	0
1	1

(Double NC)

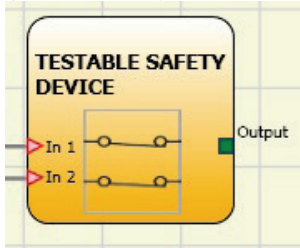

In 1	In 2	Output	Simultaneity error
0	0	0	-
0	1	0	X
1	0	0	X
1	1	1	-

(Double NC - NO)

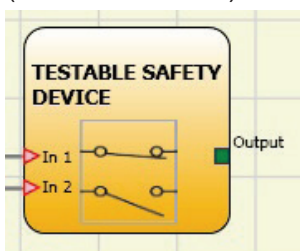

In 1	In 2	Output	Simultaneity error
0	0	0	X
0	1	0	-
1	0	1	-
1	1	0	X

Simultaneity error = the max. time between switching of the single contacts has been exceeded.

WARNING: If the Manual Reset is active, a consecutive Input has to be used. Example: In 1 and In 2 are used for the functional block, then In 3 has to be used for the Reset Input.

Parameters

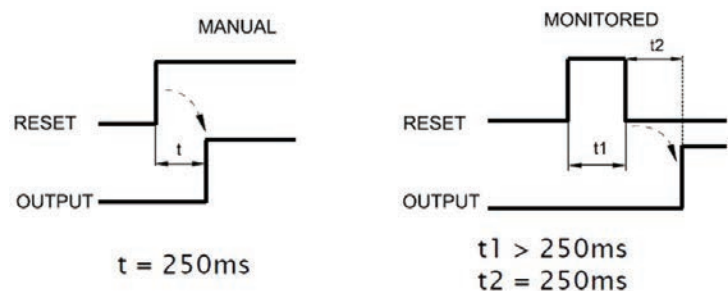

Output Test:

Permits selection of the test output signals to be sent to the contacts. This additional control permits detection and management of any short-circuits between the lines. To enable this control, the test output signals must be configured (amongst those available).

Startup Test:

If selected, enables the power-on test of the device. This test requires activation and de-activation of the device in order to run a complete functional check and enable the Output terminal. This test is required only at machine start-up (power-on of the module).

Filter (ms):

Permits filtering of signals from the device. This filter can be set to between 3 and 250 ms and eliminates any rebounds on the contacts. The duration of the filter affects calculation of module total response time.

With Simultaneity:

If selected, activates control of simultaneity between switching of signals from the device.

Simultaneity (ms):

Is active only if the previous parameter is enabled. Determines the maximum permissible time (msec) between switching of two different signals from the sensor.

Enable Error Out:

If selected reports a fault detected by the function block.

Item Description:

This allows a description of the component's function to be entered. The text is displayed in the top part of the symbol.

SOLID STATE DEVICE

The SOLID STATE DEVICE functional block checks the status of the Inx inputs. If the inputs are at 24 V DC, the Output will be 1 (TRUE), otherwise the OUTPUT will be 0 (FALSE).

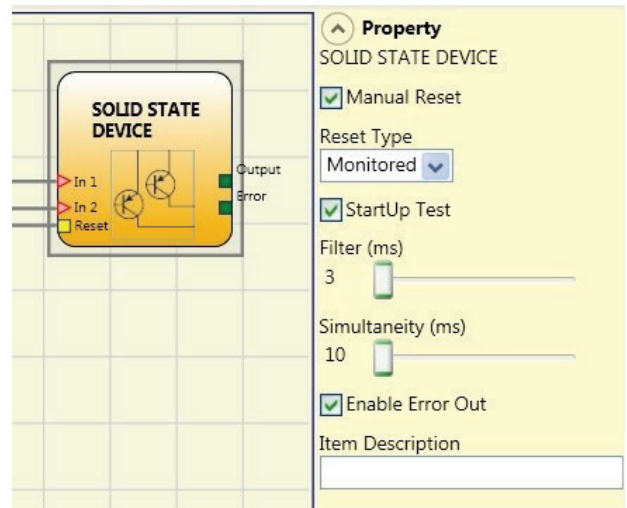
**Parameters****Manual Reset:**

If selected, enables the reset request after each occupation of the area protected by the light curtain. Otherwise, enabling of the output follows directly the conditions of the inputs

There are two types of reset:

Manual and Monitored.

Selecting the Manual option, only transition of the signal from 0 to 1 is checked. If Monitored is selected, double transition from 0 to 1 and return to 0 is checked.

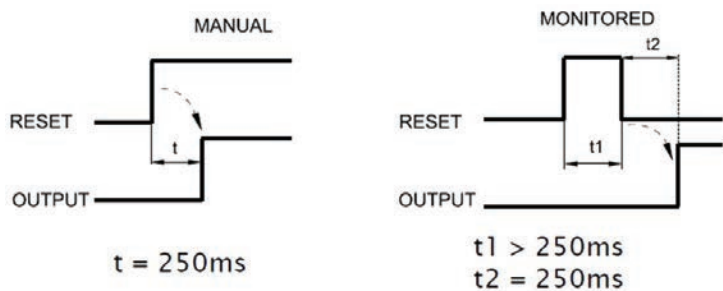

WARNING: If the Manual Reset is active, a consecutive Input has to be used. Example: In 1 and In 2 are used for the functional block, then In 3 has to be used for the Reset Input.

**Startup Test:**

If selected, enables the power-on test of the safety device. This test requires activation and de-activation of the device in order to run a complete functional check and enable the Output terminal. This test is required only at machine start-up (power-on of the module).

Filter (ms):

Permits filtering of signals from the safety device. This filter can be set to between 3 and 250 ms and eliminates any rebounds on the contacts. The duration of the filter affects calculation of module total response time.

Simultaneity (ms):

Determines that maximum permissible time (msec) between switching of two different signals from the device.

Enable Error Out:

If selected reports a fault detected by the function block.

Item Description:

This allows a description of the component's function to be entered. The text is displayed in the top part of the symbol.

FIELDBUS INPUT

Element that permits insertion of a non-safety input whose status is modified via the fieldbus.

It is possible to insert a maximum of 32 virtual inputs with UG 6911.12/080 or 8 with UG 6911.10. The bit on which status is to be modified must be selected for each. On the fieldbus the states are represented with 4 bytes with UG 6911.12/080 and 1 Byte with UG 6911.10.

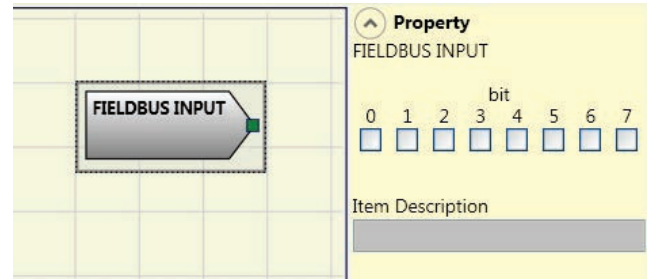

(For more detailed information, consult the fieldbus manual on the SAFEMASTER PRO Designer CD-ROM)

Parameters

Item Description:

This allows a description of the component's function to be entered. The text is displayed in the top part of the symbol.

 **WARNING:** the FIELDBUS INPUT is **NOT** a safety input !

LLO, LL1

They allow to feed in a logical level at the input of a component.

- LL0 → Logical level 0
- LL1 → Logical level 1



 **IMPORTANT:** LLO and LL1 cannot be used to disable the logical operators (AND, OR, XOR ...) in the diagram

NETWORK IN

The function block NETWORK implements a Network connection input interface; it generates an LL1 in the OUT output when the line is high, otherwise an LL0.

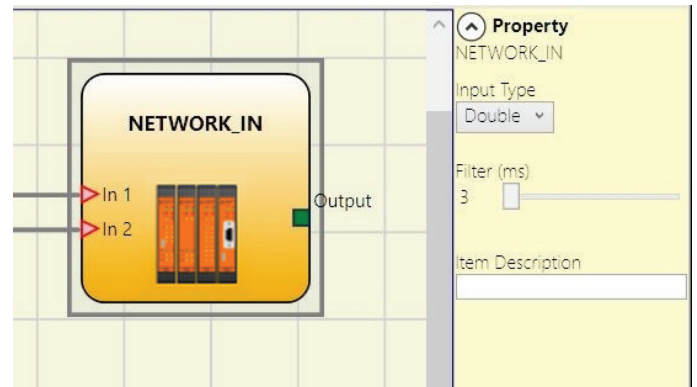
**Parameters**

Input Type:

- Single: Enables the connection of signalling outputs of an additional UG 6911 unit
- Double: Enables the connection of OSSD outputs of an additional UG 6911 unit

Filter (ms):

Enables the filtering of signals from an additional UG6911 unit. This filter can be set to between 3 and 250 ms. The length of the filter affects the calculation of the unit's total response time.



These inputs can only be applied to the master unit UG 6911.





They must be used when OSSD outputs are connected to the inputs of a second SAFEMASTER PRO system or together with the NETWORK operator.

SPEED CONTROL TYPE FUNCTION BLOCKS

Warning concerning safety:

 An external error or malfunction deriving from encoder/proximity or its wiring, does not necessarily involve a change of safety status of the normal output (i.e. “Zero”) of the function block.

 Failures or malfunctions of encoder/proximity switch or its wiring are then recognized by the module, managed and specified via the diagnostic bit on every function block (“Enable Error Out”)

 To ensure the safety features the diagnostic bit has to be used in the configuration program created by the user to cause a possible deactivation of the outputs if the axis is working. In absence of encoder/proximity external anomalies, Error bit will be equal to 0 (zero)

In presence of encoder/proximity external anomalies, error_out bit will be equal to 1 (one):

- Absence of encoder or proximity
- Absence of one or more wiring from encoder / proximity
- Absence of encoder power supply (only model with TTL external power supply)
- Error of congruence frequencies between signals from encoder/proximity
- Phase error between signals from the encoder or duty cycle error of a single phase

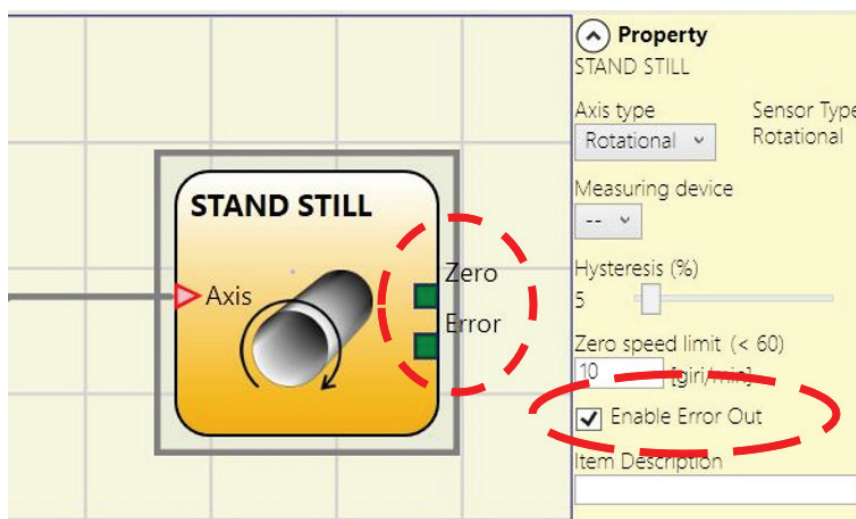

Example of speed control functional block

NOTE CONCERNING SPEED CONTROL FUNCTIONAL BLOCKS

Starting from the SAFEMASTER PRO Designer 1.8.0 Software Version the Speed Control Functional Blocks provide a graphical visualization of the configured thresholds.

In the figure on the right it is represented an example of a 3 thresholds graphical diagram. The solid line represents the threshold value while the dotted line represents how much hysteresis is applied to the threshold value.

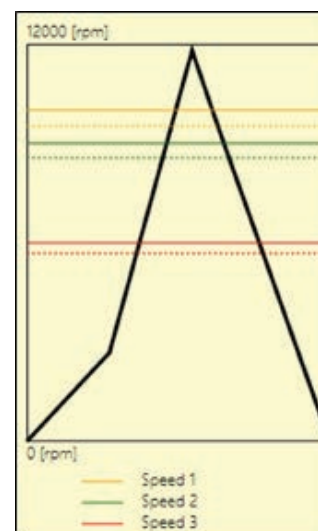

SPEED CONTROL

The SPEED CONTROL function block monitors the speed of a device generating an output 0 (FALSE) when the measured speed exceeds a predetermined threshold. In the case in which the speed is below the predetermined threshold the output will be 1 (TRUE).

Parameters

Axis Type:

It defines the type of axis controlled by the device. It will be Linear in the case of a translation and will be Rotary in the case of motion around an axis.

Sensor Type:

In the event that the previous parameter is Linear, the Sensor Type defines the type of sensor connected to the module inputs. It can be Rotary (e.g. shaft encoder) or Linear (e.g. optical array). This choice allows to define the following parameters.

Measuring device:

It defines the type of sensor(s) used.

The possible choices are:

- Encoder
- Proximity
- Encoder + Proximity
- Proximity1 + Proximity2
- Encoder1 + Encoder2

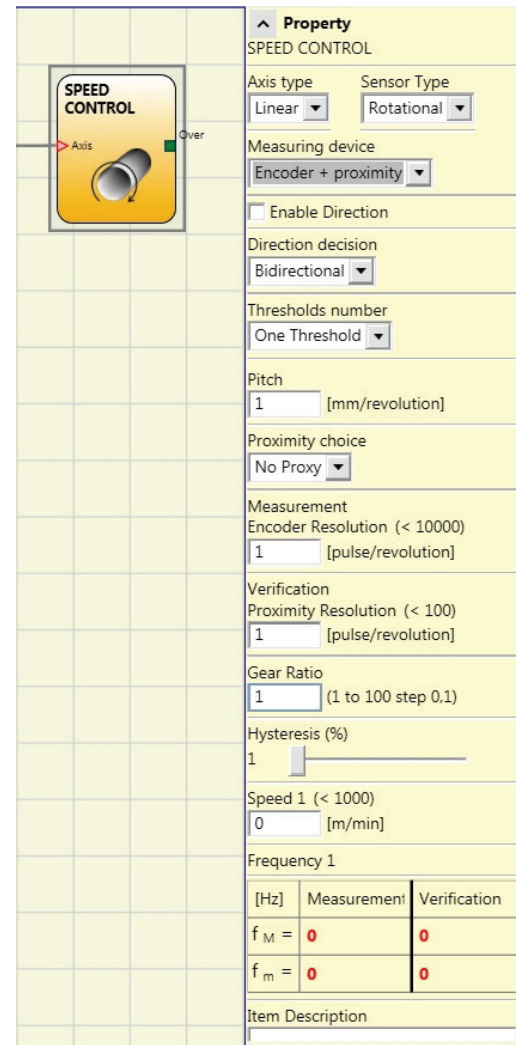

Sin/Cos:

Disable Analog check: When a Sin/Cos Module is used, it is possible to disable the analog verification $\sin^2\theta + \cos^2\theta$, carrying out a simplified plausibility check of the Encoder signals.

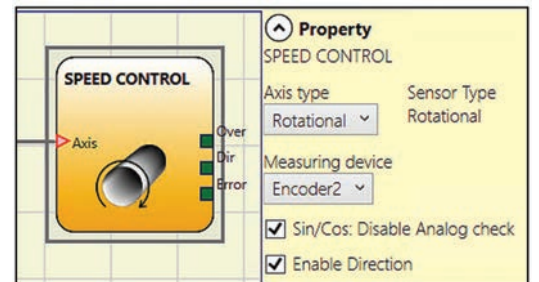

[Hz]	Measurement	Verification
f _M =	0	0
f _m =	0	0



 When analogue control is disabled, the diagnostic coverage decreases.
 In addition, the safety level of the project drops from: SIL 3 → SIL 2 / PL e → PL d.
 Please refer to chapter "Important safety instructions."

Parameters

Enable direction:

Enabling this parameter, the DIR output is enabled on the function block. This output will be 1 (TRUE) when the axis rotates Counterclockwise and will be 0 (FALSE) when the axis rotates Clockwise.

Direction decision:

It defines the direction of rotation for which the set thresholds are made active. The possible choices are:

- Bidirectional
- Clockwise
- Counterclockwise

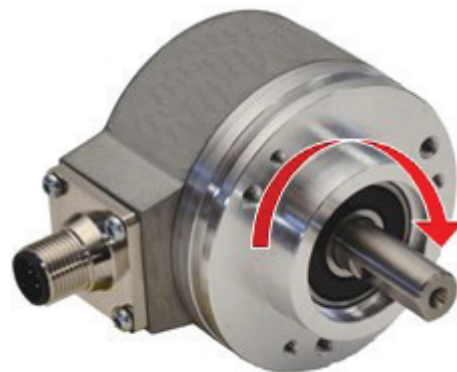

If Bidirectional is selected, the excess of the set threshold is detected whether the axis rotates clockwise or counterclockwise. Selecting Clockwise or Counterclockwise, this is detected only when the axis rotates in the selected direction.

2 threshold settings	
In ₁	Threshold No.
0	Speed 1
1	Speed 2

4 threshold settings		
In ₂	In ₁	Threshold No.
0	0	Speed 1
0	1	Speed 2
1	0	Speed 3
1	1	Speed 4

8 threshold settings			
In ₃	In ₂	In ₁	Threshold No.
0	0	0	Speed 1
0	0	1	Speed 2
0	1	0	Speed 3
0	1	1	Speed 4
1	0	0	Speed 5
1	0	1	Speed 6
1	1	0	Speed 7
1	1	1	Speed 8

Threshold number:

It allows you to enter the number of thresholds for the maximum value of speed. Changing this value will increase/ decrease the number of thresholds that can be entered from a minimum of 1 to a maximum of 8 with UG 6911.10 (FW ≥ 4.0 and UG 6917 FW ≥ 2.0) and 4 with UG 6911.10 (FW < 4.0) or UG 6911.12/080 or UG 6917 (FW < 2.0). In the case of thresholds greater than 1, the input pins for the selection of the specific threshold will appear in the lower part of the function block.

Pitch:

If the Axis Type chosen was linear, this field allows you to enter the sensor pitch to obtain a conversion between sensor revolutions and distance travelled.

Proximity choice:

It allows you to choose the type of proximity sensor from PNP, NPN, Normally Open (NO) and Normally Closed (NC), with 3 or 4 wires.

(In order to ensure a Performance Level = PLe use a proximity switch type PNP, NO)

Proximity Interleaved:

When an axis of the UG 6917 module is configured for a measurement with two proximity switches, these can be configured in interleaved mode. Under the conditions listed below the system reaches a Performance Level = PL_e

- Proximity switches must be fitted such that the recorded signals overlap
- Proximity switches must be fitted such that at least one is always activated

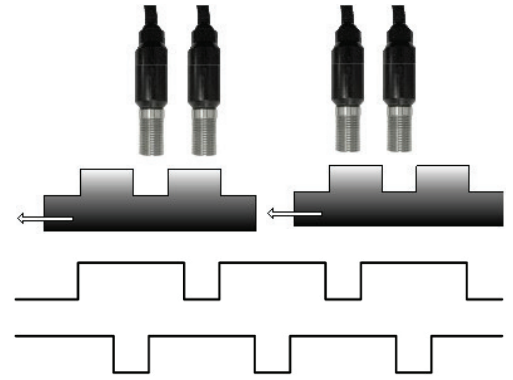
Measurement:

Enter in this field the number of pulses/revolution (in the case of rotary sensor) or μm / pulse (linear sensor) relating to the sensor used.

Verification:

Enter in this field the number of pulses/revolution (in the case of rotary sensor) or μm /pulse (linear sensor) relating to the second sensor used.

Gear Ratio:

This parameter is active if there are two sensors on the selected axis. This parameter allows you to enter the ratio between the two sensors. If both sensors are on the same moving parts, the ratio will be 1 otherwise the number corresponding to the report must be entered. E.g. there are an encoder and a proximity switch, and the latter is on a moving part that (due to a gear reduction ratio) rotates at twice the speed of the encoder. Therefore, this value must be set at 2.

Hysteresis (%):

It represents the percentage hysteresis value below which the speed change is filtered. Enter a value other than 1 to avoid continuous switching as the input changes.

Speed 1 ... 8:

Enter in this field the maximum speed value above which the function block output (OVER) will be 0 (FALSE). If the measured speed is less than the set value, the function block output (OVER) will be 1 (TRUE). If UG 6911.10 ($\text{FW} \geq 4.0$ and UG 6917 $\text{FW} \geq 2.0$), it's possible to enter the speed value with the decimal point (not with UG 6911.12/080).

Frequenz:

It shows the maximum calculated frequency values f_M and f_m (decreased by the hysteresis set). If the displayed value is GREEN, the calculation of frequency gave a positive result.

If the displayed value is RED, it is necessary to change the parameters given in the following formulas.

1. Rotary axis, rotary sensor. The frequency obtained is:

$$f[\text{Hz}] = \frac{\text{rpm} [\text{rev} / \text{min}]}{60} \times \text{Resolution} [\text{pulses} / \text{rev}]$$

2. Linear axis, rotary sensor. The frequency obtained is:

$$f[\text{Hz}] = \frac{\text{speed} [\text{m} / \text{min}] \times 1000}{60 \times \text{pitch} [\text{mm} / \text{rev}]} \times \text{Resolution} [\text{pulses} / \text{rev}]$$

3. Linear axis, linear sensor. The frequency obtained is:

$$f[\text{Hz}] = \frac{\text{speed} [\text{mm} / \text{s}] \times 1000}{\text{Resolution} [\mu\text{m} / \text{pulse}]}$$

4. Hysteresis. To be changed only if: f_M = GREEN; f_m = RED

f = Frequency Rpm = Rotational speed
 Resolution = Measurement Speed = Linear speed Pitch = Sensor pitch

WINDOW SPEED CONTROL

The WINDOW SPEED CONTROL function block monitors the speed of a device, generating the Zero to 1 (TRUE) output when the speed is within a prefixed range.

Parameters

Axis Type:

It defines the type of axis controlled by the device. It will be Linear in the case of a translation and will be Rotary in the case of motion around an axis.

Sensor Type:

In the event that the previous parameter is Linear, the Sensor Type defines the type of sensor connected to the module inputs. It can be Rotary (e.g. shaft encoder) or Linear (e.g. optical array). This choice allows to define the following parameters.

Measuring device:

It defines the type of sensor(s) used. The possible choices are:

- Encoder
- Proximity
- Encoder + Proximity
- Proximity1 + Proximity2
- Encoder1 + Encoder2

Sin/Cos:

Disable Analog check: When a Sin/Cos Module is used, it is possible to disable the analog verification $\sin^2\theta + \cos^2\theta$, carrying out a simplified plausibility check of the Encoder signals.

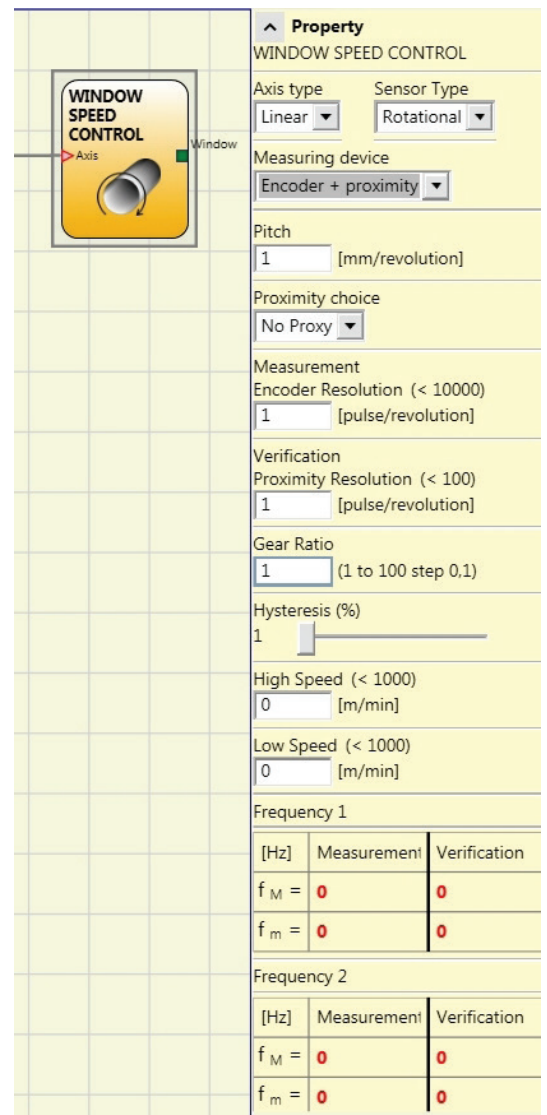
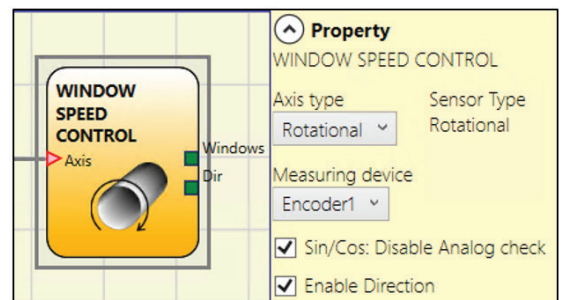
 When analogue control is disabled, the diagnostic coverage decreases.

 In addition, the safety level of the project drops from: SIL 3 → SIL 2 / PL e → PL d.

 Please refer to chapter "Important safety instructions."

Parameters

Pitch:
If the Axis Type chosen was linear, this field allows you to enter the sensor pitch to obtain a conversion between sensor revolutions and distance travelled.

Proximity choice:
It allows you to choose the type of proximity sensor from PNP, NPN, Normally Open (NO) and Normally Closed (NC), with 3 or 4 wires.

(In order to ensure a Performance Level = PLe use a proximity switch type PNP, NO)

Proximity Interleaved:
When an axis of the UG 6917 module is configured for a measurement with two proximity switches, these can be configured in interleaved mode. Under the conditions listed below the system reaches a Performance Level = PLe

- Proximity switches must be fitted such that the recorded signals overlap
- Proximity switches must be fitted such that at least one is always activated

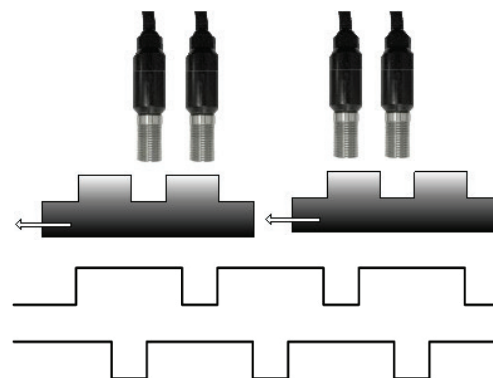

Measurement:
Enter in this field the number of pulses/revolution (in the case of rotary sensor) or $\mu\text{m}/\text{pulse}$ (linear sensor) relating to the sensor used.

Verification:
Enter in this field the number of pulses/revolution (in the case of rotary sensor) or $\mu\text{m}/\text{pulse}$ (linear sensor) relating to the second sensor used.

Gear Ratio:
This parameter is active if there are two sensors on the selected axis. This parameter allows you to enter the ratio between the two sensors. If both sensors are on the same moving parts, the ratio will be 1 otherwise the number corresponding to the report must be entered. E.g. there are an encoder and a proximity switch, and the latter is on a moving part that (due to a gear reduction ratio) rotates at twice the speed of the encoder. Therefore, this value must be set at 2.

Hysteresis (%):
It represents the percentage hysteresis value below which the speed change is filtered. Enter a value other than 1 to avoid continuous switching as the input changes.

High Speed:
Enter in this field the maximum speed value above which the output of the function block (WINDOW) will be 0 (FALSE). If the measured speed is less than the set value, the output (WINDOW) of the function block will be 1 (TRUE). If UG 6911.10 ($\text{FW} \geq 4.0$ and UG 6917 $\text{FW} \geq 2.0$), it's possible to enter the speed value with the decimal point (not with UG 6911.12/080).

Low Speed:
Enter in this field the minimum speed value below which the output of the function block (WINDOW) will be 0 (FALSE). If the measured speed is more than the set value, the output (WINDOW) of the function block will be 1 (TRUE). If UG 6911.10 ($\text{FW} \geq 4.0$ and UG 6917 $\text{FW} \geq 2.0$), it's possible to enter the speed value with the decimal point (not with UG 6911.12/080).

Parameters

Frequency:

It shows the maximum calculated frequency values f_M and f_m (decreased by the hysteresis set). If the displayed value is GREEN, the calculation of frequency gave a positive result.

If the displayed value is RED, it is necessary to change the parameters given in the following formulas.

1. Rotary axis, rotary sensor. The frequency obtained is:

$$f[\text{Hz}] = \frac{\text{rpm} [\text{rev} / \text{min}]}{60} \times \text{Resolution} [\text{pulses} / \text{rev}]$$

2. Linear axis, rotary sensor. The frequency obtained is:

$$f[\text{Hz}] = \frac{\text{speed} [\text{m} / \text{min}] \times 1000}{60 \times \text{pitch} [\text{mm} / \text{rev}]} \times \text{Resolution} [\text{pulses} / \text{rev}]$$

3. Linear axis, linear sensor. The frequency obtained is:

$$f[\text{Hz}] = \frac{\text{speed} [\text{mm} / \text{s}] \times 1000}{\text{Resolution} [\mu\text{m} / \text{pulse}]}$$

4. Hysteresis. To be changed only if: $f_M = \text{GREEN}$; $f_m = \text{RED}$

f = Frequency Rpm = Rotational speed
 $Resolution$ = Measurement $Speed$ = Linear speed $Pitch$ = Sensor pitch

STAND STILL

The function block STAND STILL monitors the speed of a device, generating the Zero to 1 (TRUE) output when the speed is lower than a selected value.

Parameters

Axis Type:

It defines the type of axis controlled by the device. It will be Linear in the case of a translation and will be Rotary in the case of motion around an axis.

Sensor Type:

In the event that the previous parameter is Linear, the Sensor Type defines the type of sensor connected to the module inputs. It can be Rotary (e.g. shaft encoder) or Linear (e.g. optical array). This choice allows to define the following parameters.

Measuring device:

It defines the type of sensor(s) used. The possible choices are:

- Encoder
- Proximity
- Encoder + Proximity
- Proximity1 + Proximity2
- Encoder1 + Encoder2

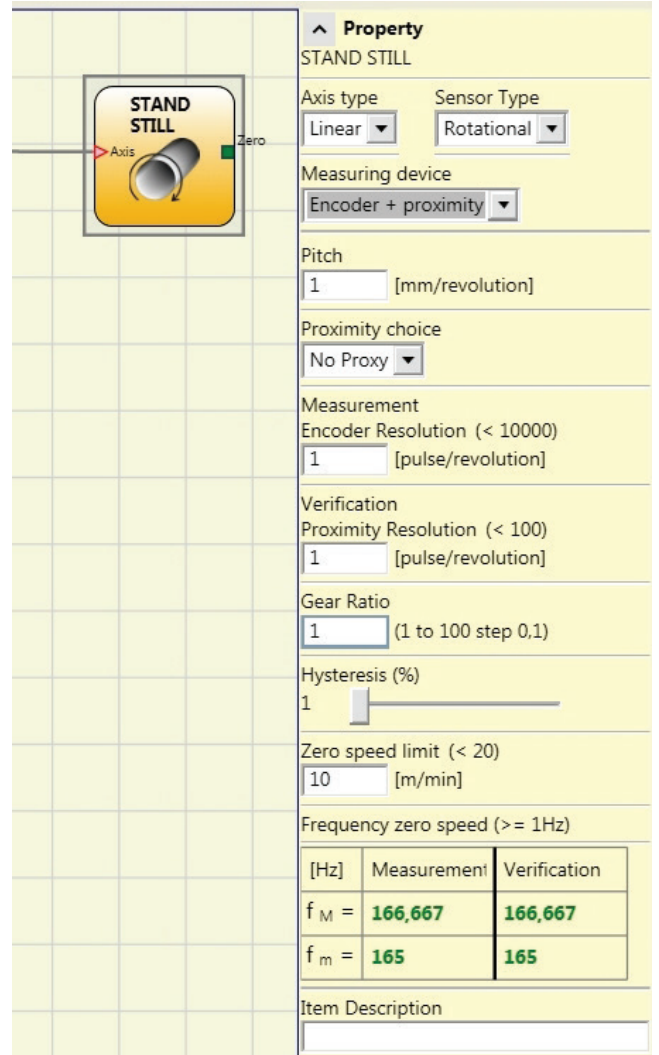

Sin/Cos:

Disable Analog check: When a Sin/Cos Module is used, it is possible to disable the analog verification $\sin^2\theta + \cos^2\theta$, carrying out a simplified plausibility check of the Encoder signals.

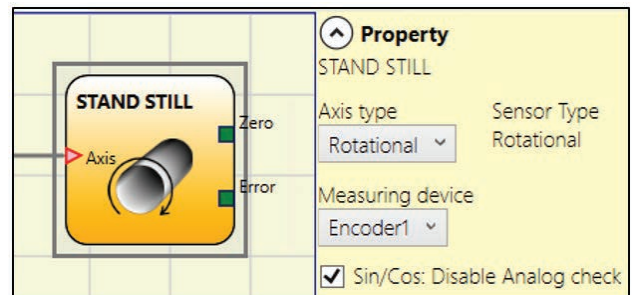

[Hz]	Measurement	Verification
$f_M =$	166,667	166,667
$f_m =$	165	165



 When analogue control is disabled, the diagnostic coverage decreases.
 In addition, the safety level of the project drops from: SIL 3 → SIL 2 / PL e → PL d.
 Please refer to chapter "Important safety instructions."

Parameters

Pitch:

If the Axis Type chosen was linear, this field allows you to enter the sensor pitch to obtain a conversion between sensor revolutions and distance travelled.

Proximity choice:

It allows you to choose the type of proximity sensor from PNP, NPN, Normally Open (NO) and Normally Closed (NC), with 3 or 4 wires.

(In order to ensure a Performance Level = PLe use a proximity switch type PNP, NO)

Proximity Interleaved:

When an axis of the UG 6917 module is configured for a measurement with two proximity switches, these can be configured in interleaved mode. Under the conditions listed below the system reaches a Performance Level = PLe

- Proximity switches must be fitted such that the recorded signals overlap.
- Proximity switches must be fitted such that at least one is always activated.

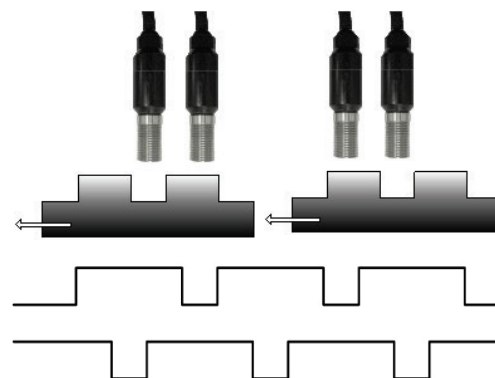

Measurement:

Enter in this field the number of pulses/revolution (in the case of rotary sensor) or $\mu\text{m}/\text{pulse}$ (linear sensor) relating to the sensor used.

Verification:

Enter in this field the number of pulses/revolution (in the case of rotary sensor) or $\mu\text{m}/\text{pulse}$ (linear sensor) relating to the second sensor used.

Gear Ratio:

This parameter is active if there are two sensors on the selected axis. This parameter allows you to enter the ratio between the two sensors. If both sensors are on the same moving parts, the ratio will be 1 otherwise the number corresponding to the report must be entered. E.g. there are an encoder and a proximity switch, and the latter is on a moving part that (due to a gear reduction ratio) rotates at twice the speed of the encoder. Therefore, this value must be set at 2.

Hysteresis (%):

It represents the percentage hysteresis value below which the speed change is filtered. Enter a value other than 1 to avoid continuous switching as the input changes.

Zero speed limit:

Enter in this field the maximum speed value above which the output of the function block (ZERO) will be 0 (FALSE). If the measured speed is less than the set value, the output (ZERO) of the function block will be 1 (TRUE).

Parameters

Frequency zero speed:

It shows the maximum calculated frequency values f_M and f_m (decreased by the hysteresis set). If the displayed value is GREEN, the calculation of frequency gave a positive result.

If the displayed value is RED, it is necessary to change the parameters given in the following formulas.

1. Rotary axis, rotary sensor. The frequency obtained is:

$$f[\text{Hz}] = \frac{\text{rpm} [\text{rev} / \text{min}]}{60} \times \text{Resolution} [\text{pulses} / \text{rev}]$$

2. Linear axis, rotary sensor. The frequency obtained is:

$$f[\text{Hz}] = \frac{\text{speed} [\text{m} / \text{min}] \times 1000}{60 \times \text{pitch} [\text{mm} / \text{rev}]} \times \text{Resolution} [\text{pulses} / \text{rev}]$$

3. Linear axis, linear sensor. The frequency obtained is:

$$f[\text{Hz}] = \frac{\text{speed} [\text{mm} / \text{s}] \times 1000}{\text{Resolution} [\mu\text{m} / \text{pulse}]}$$

4. Hysteresis. To be changed only if: $f_M = \text{GREEN}$; $f_m = \text{RED}$

f = Frequency Rpm = Rotational speed
 $Resolution$ = Measurement $Speed$ = Linear speed $Pitch$ = Sensor pitch

STAND STILL AND SPEED CONTROL

The function block STAND STILL AND SPEED CONTROL monitors the speed of a device, generating the Zero to 1 (TRUE) output when the speed is lower than a selected value. In addition, it generates the Over = 0 (FALSE) output if the measured speed exceeds a predetermined threshold.

Parameters

Axis Type:

It defines the type of axis controlled by the device. It will be Linear in the case of a translation and will be Rotary in the case of motion around an axis.

Sensor Type:

In the event that the previous parameter is Linear, the Sensor Type defines the type of sensor connected to the module inputs. It can be Rotary (e.g. shaft encoder) or Linear (e.g. optical array). This choice allows to define the following parameters.

Measuring device:

It defines the type of sensor(s) used. The possible choices are:

- Encoder
- Proximity
- Encoder + Proximity
- Proximity1 + Proximity2
- Encoder1 + Encoder2

Sin/Cos:

Disable Analog check: When a Sin/Cos Module is used, it is possible to disable the analog verification $\sin^2\theta + \cos^2\theta$, carrying out a simplified plausibility check of the Encoder signals.

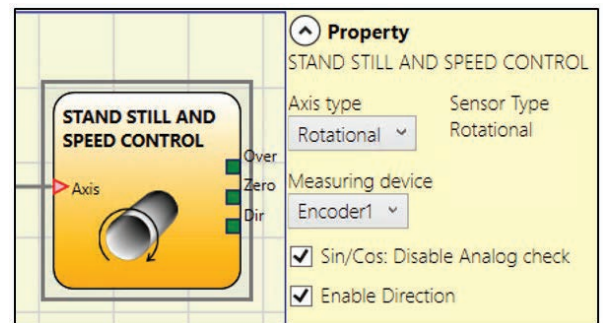
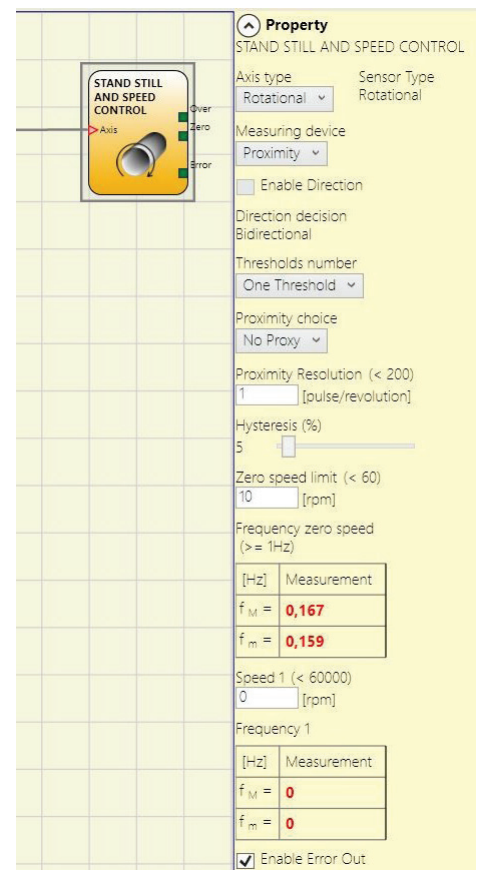

 When analogue control is disabled, the diagnostic coverage decreases.

 In addition, the safety level of the project drops from: SIL 3 → SIL 2 / PL e → PL d.

 Please refer to chapter "Important safety instructions."

Parameters

Enable direction:

Enabling this parameter, the DIR output is enabled on the function block. This output will be 1 (TRUE) when the axis rotates Counterclockwise and will be 0 (FALSE) when the axis rotates Clockwise.

Direction decision:

It defines the direction of rotation for which the set thresholds are made active.

The possible choices are:

- Bidirectional
- Clockwise
- Counterclockwise

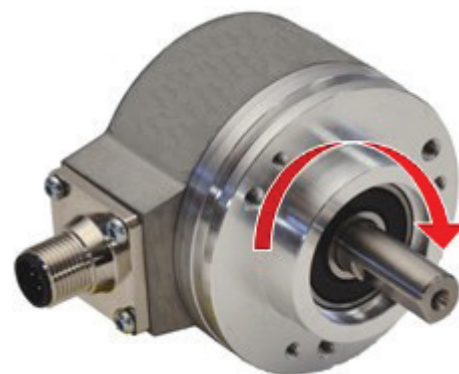

Example of CLOCKWISE axis rotation

If Bidirectional is selected, the excess of the set threshold is detected whether the axis rotates clockwise or counterclockwise. Selecting Clockwise or Counterclockwise, this is detected only when the axis rotates in the selected direction.

2 threshold settings	
In ₁	Threshold No.
0	Speed 1
1	Speed 2

4 threshold settings		
In ₂	In ₁	Threshold No.
0	0	Speed 1
0	1	Speed 2
1	0	Speed 3
1	1	Speed 4

8 threshold settings			
In ₃	In ₂	In ₁	Threshold No.
0	0	0	Speed 1
0	0	1	Speed 2
0	1	0	Speed 3
0	1	1	Speed 4
1	0	0	Speed 5
1	0	1	Speed 6
1	1	0	Speed 7
1	1	1	Speed 8

Threshold number:

It allows you to enter the number of thresholds for the maximum value of speed. Changing this value will increase/decrease the number of thresholds that can be entered from a minimum of 1 to a maximum of 8 with UG 6911.10 (FW ≥ 4.0 und UG 6917 FW ≥ 2.0) and 4 with UG 6911.10 (FW < 4.0) or UG 6911.12/080 or UG 6917 (FW < 2.0). In the case of thresholds greater than 1, the input pins for the selection of the specific threshold will appear in the lower part of the function block.

Pitch:

If the Axis Type chosen was linear, this field allows you to enter the sensor pitch to obtain a conversion between sensor revolutions and distance travelled.

Proximity choice:

It allows you to choose the type of proximity sensor from PNP, NPN, Normally Open (NA) and Normally Closed (NC), with 3 or 4 wires.

(In order to ensure a Performance Level = PLe use a proximity switch type PNP, NO)

Parameters

Proximity Interleaved:

When an axis of the UG 6917 module is configured for a measurement with two proximity switches, these can be configured in interleaved mode. Under the conditions listed below the system reaches a Performance Level = PLe

- Proximity switches must be fitted such that the recorded signals overlap.
- Proximity switches must be fitted such that at least one is always activated

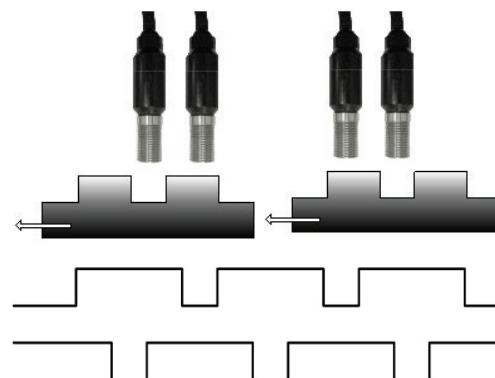

Frequenz:

It shows the maximum calculated frequency values f_M and f_m (decreased by the hysteresis set). If the displayed value is GREEN, the calculation of frequency gave a positive result.

If the displayed value is RED, it is necessary to change the parameters given in the following formulas.

1. Rotary axis, rotary sensor. The frequency obtained is:

$$f[\text{Hz}] = \frac{\text{rpm} [\text{rev} / \text{min}]}{60} \times \text{Resolution} [\text{pulses} / \text{rev}]$$

2. Linear axis, rotary sensor. The frequency obtained is:

$$f[\text{Hz}] = \frac{\text{speed} [\text{m} / \text{min}] \times 1000}{60 \times \text{pitch} [\text{mm} / \text{rev}]} \times \text{Resolution} [\text{pulses} / \text{rev}]$$

3. Linear axis, linear sensor. The frequency obtained is:

$$f[\text{Hz}] = \frac{\text{speed} [\text{mm} / \text{s}] \times 1000}{\text{Resolution} [\mu\text{m} / \text{pulse}]}$$

4. Hysteresis. To be changed only if: $f_M = \text{GREEN}$; $f_m = \text{RED}$

f = Frequency Rpm = Rotational speed
 $Resolution$ = Measurement $Speed$ = Linear speed $Pitch$ = Sensor pitch

Measurement:

Enter in this field the number of pulses/revolution (in the case of rotary sensor) or $\mu\text{m}/\text{pulse}$ (linear sensor) relating to the sensor used.

Verification:

Enter in this field the number of pulses/revolution (in the case of rotary sensor) or $\mu\text{m}/\text{pulse}$ (linear sensor) relating to the second sensor used.

Gear Ratio:

This parameter is active if there are two sensors on the selected axis. This parameter allows you to enter the ratio between the two sensors. If both sensors are on the same moving parts, the ratio will be 1 otherwise the number corresponding to the report must be entered. E.g. there are an encoder and a proximity switch, and the latter is on a moving part that (due to a gear reduction ratio) rotates at twice the speed of the encoder. Therefore, this value must be set at 2.

Hysteresis (%):

It represents the percentage hysteresis value below which the speed change is filtered. Enter a value other than 1 to avoid continuous switching as the input changes.

Parameters

Zero speed limit:

Enter in this field the maximum speed value above which the output of the function block (ZERO) will be 0 (FALSE). If the measured speed is less than the set value, the output (ZERO) of the function block will be 1 (TRUE).

Speed 1 ... 8:

Enter in this field the maximum speed value above which the function block output (OVER) will be 0 (FALSE). If the measured speed is less than the set value, the function block output (OVER) will be 1 (TRUE).

If UG 6911.10 (FW \geq 4.0 and UG 6917 FW \geq 2.0), it's possible to enter the speed value with the decimal point (not with UG 6911.12/080).

TEXT BLOCKS

Comments

This allows a description to be entered and placed in any point of the diagram.

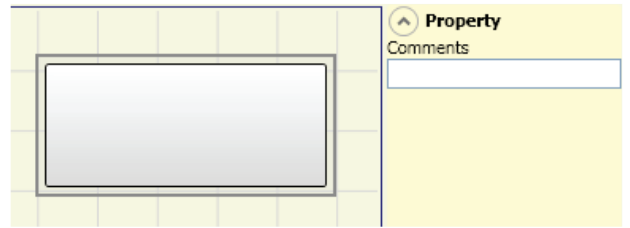

Title

Automatically adds the name of the manufacturer, the designer, the project name and the CRC.

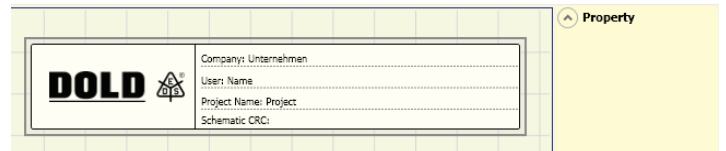

OPERATOR FUNCTION BLOCKS

All the input of these operators could be inverted (logical NOT). It could be done clicking with the right mouse key on the input to be inverted. A little circle will be showed on the inverted input. To cancel the inversion, simply click another time on the same input pin.

 The maximum number of user blocks is 64 at UG 6911.10 and 128 at UG 6911.12/080.

LOGICAL OPERATORS

AND

Logical AND returns an output of 1 (TRUE) if all the inputs are 1 (TRUE).

In ₁	In ₂	In _x	Out
0	0	0	0
1	0	0	0
0	1	0	0
1	1	0	0
0	0	1	0
1	0	1	0
0	1	1	0
1	1	1	1

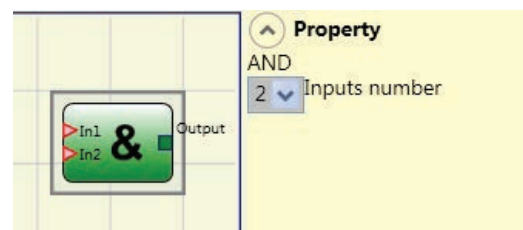

Parameters

Inputs number: This is used to set between 2 and 8 inputs.

NAND

Logical NAND returns an output of 0 (FALSE) if all the inputs are 1 (TRUE).

In ₁	In ₂	In _x	Out
0	0	0	1
1	0	0	1
0	1	0	1
1	1	0	1
0	0	1	1
1	0	1	1
0	1	1	1
1	1	1	0

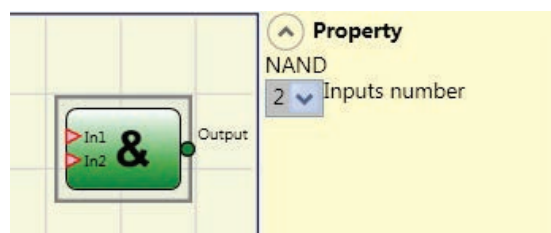

Parameters

Inputs number: This is used to set between 2 and 8 inputs.

NOT

Logical NOT inverts the logical status of the input

In	Out
0	1
1	0

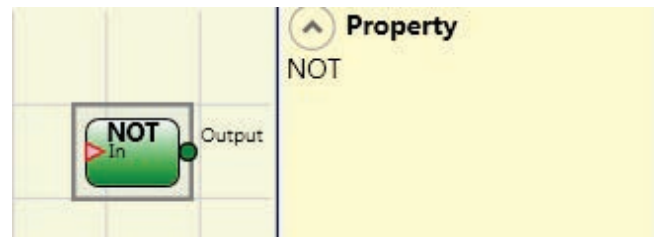

OR

Logical OR returns an output of 1 (TRUE) if at least one of the inputs is 1 (TRUE).

In ₁	In ₂	In _x	Out
0	0	0	0
1	0	0	1
0	1	0	1
1	1	0	1
0	0	1	1
1	0	1	1
0	1	1	1
1	1	1	1

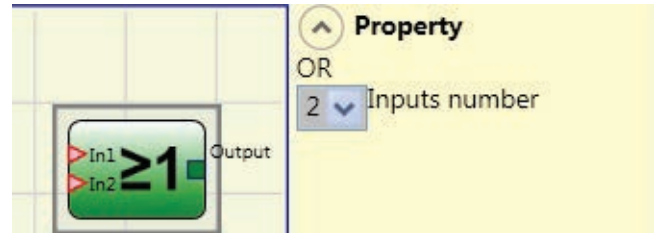

Parameters

Inputs number: This is used to set between 2 and 8 inputs.

NOR

Logical NOR returns an output of 0 (FALSE) if at least one of the inputs is 1 (TRUE).

In ₁	In ₂	In _x	Out
0	0	0	1
1	0	0	0
0	1	0	0
1	1	0	0
0	0	1	0
1	0	1	0
0	1	1	0
1	1	1	0

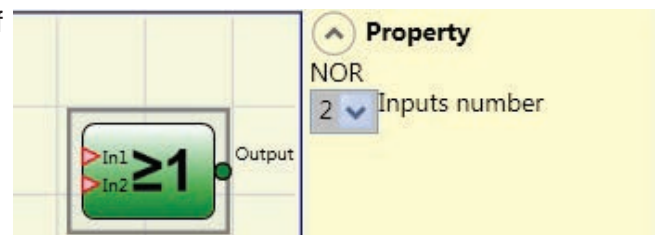

Parameters

Inputs number: This is used to set between 2 and 8 inputs.

XOR

Logical XOR returns an output 0 (FALSE) if the input's number at 1 (TRUE) is even or the inputs are all 0 (FALSE).

In ₁	In ₂	In _x	Out
0	0	0	0
1	0	0	1
0	1	0	1
1	1	0	0
0	0	1	1
1	0	1	0
0	1	1	0
1	1	1	1

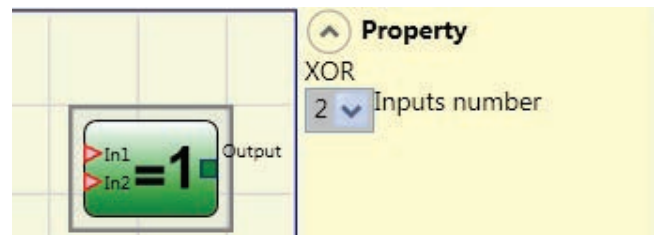
**Parameters**

Inputs number: This is used to set between 2 and 8 inputs.

XNOR

Logical XNOR returns an output 1 (TRUE) if the input's number at 1 (TRUE) is even or the inputs are all 0 (FALSE.)

In ₁	In ₂	In _x	Out
0	0	0	1
1	0	0	0
0	1	0	0
1	1	0	1
0	0	1	0
1	0	1	1
0	1	1	1
1	1	1	0

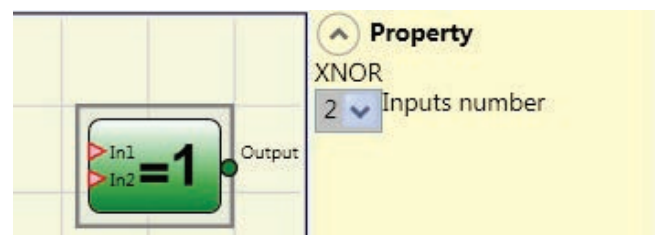
**Parameters**

Inputs number: This is used to set between 2 and 8 inputs.

LOGICAL MACRO

This operator enables the grouping together of two or three logic gates.

A maximum of 8 inputs is foreseen.

The result of the first two operators converges into a third operator, the result of which is the OUTPUT.

If one of the Logic Inputs equals "1", the corresponding logic is disabled and the input is directly connected to the end logic (refer to diagram opposite for example).

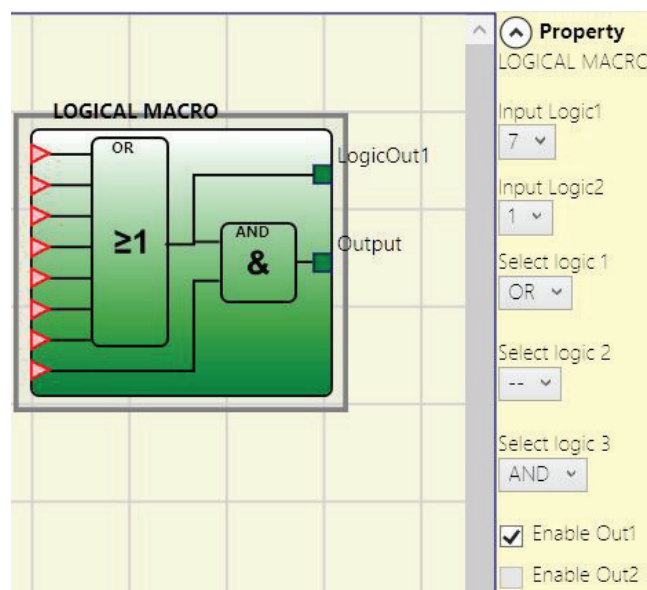

(UG 6911 Firmware Version 3.0 or higher)

Parameters

Input Logic 1, 2:

Enables the selection of the number of logic inputs (from 1 to 7).

Select Logic 1, 2, 3:

Enables the selection of one of the following types of operator AND, NAND, OR, NOR, XOR, XNOR.

Disable OUT:

If selected, it deactivates the main output allowing to use only logics 1 and 2.

Enable (OUT1, OUT2):

If selected, activates an output with the result of the first two operators.

MULTIPLEXER

Logical MULTIPLEXER forwards the signal of the inputs to the output according to the Sel selection. If the SEL1 ÷ SEL4 have only one bit set, the selected In n is connected to the Output. If the SEL inputs are:

- more than one = 1 (TRUE)
 - none = 1 (TRUE)
- The output is set to 0 (FALSE) independently from the In n values.

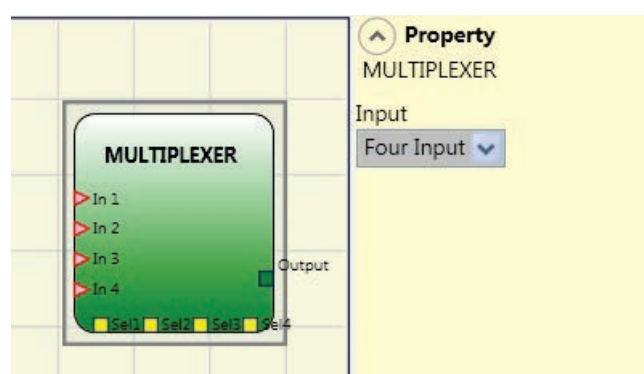

Parameters

Input:

This is used to set between 2 and 4 inputs.

DIGITAL COMPARATOR (only at UG 6911.12/080)

The Operator DIGITAL COMPARATOR allows to compare (in binary format) a group of signals with a constant or two groups of signals to each other.

Comparison with constant:

In this case the Signal Comparator check must not be activated.

The DIGITAL COMPARATOR block allows to compare a series of input signals (from 2 to a maximum of 8) with a integer constant that can vary from 0 to 255.

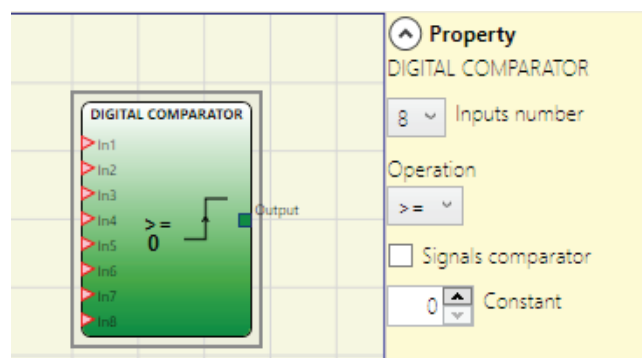

Input In1 is the LSB (least significant bit) while input In8 (or less if the number of inputs selected is less than 8) is the MSB (most significant bit).

Example of operator with 8 inputs

In1	0
In2	1
In3	1
In4	0
In5	1
In6	0
In7	0
In8	1

Decimal value equal to 150

Example of operator with 5 inputs

In1	0
In2	1
In3	0
In4	1
In5	1

Decimal value equal to 26

Among the various operations that can be used are:

- < Lower:
The OUT output will be 1 (TRUE) as long as the input value is less than the decimal value set as constant. The OUT output will be set to 0 (FALSE) when the input value is higher than or equal to the decimal value set as constant.
- ≥ Higher or equal:
The OUT output will be 1 (TRUE) as long as the input value is higher than or equal to the decimal value set as constant. The OUT output will be set to 0 (FALSE) when the input value is lower than the decimal value set as constant.
- > Higher:
The OUT output will be 1 (TRUE) as long as the input value is higher than the decimal value set as constant. The OUT output will be set to 0 (FALSE) when the input value is lower than or equal to the decimal value set as constant.
- ≤ Lower oder Equal:
The OUT output will be 1 (TRUE) as long as the input value is lower than or equal to the decimal value set as constant. The OUT output will be set to 0 (FALSE) when the input value is higher than the decimal value set as constant.
- = Equal:
The OUT output will be 1 (TRUE) as long as the input value is equal to the decimal value set as constant. The OUT output will be set to 0 (FALSE) when the input value is different from the decimal value set as constant.
- != Unequal:
The OUT output will be 1 (TRUE) as long as the input value is different from the decimal value set as constant. The OUT output will be set to 0 (FALSE) when the input value is equal to the decimal value set as constant.

DIGITAL COMPARATOR (only at UG 6911.12/080)**Signal comparison:**

Selecting this item will allow the DIGITAL COMPARATOR operator to compare the first four A inputs (In1_A...In4_A) with the second four B inputs (In1_B...In4_B).

Depending on the value of the inputs and the operation selected, the following results will be obtained:

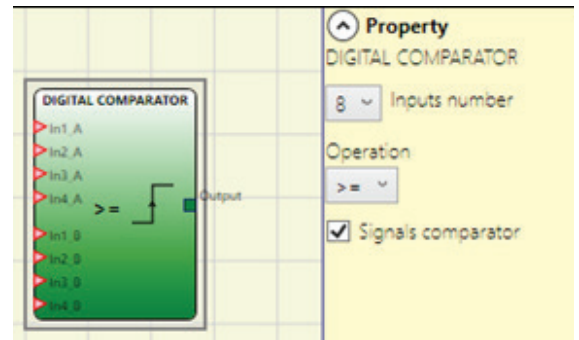

- **< Lower:**
The OUT output will be 1 (TRUE) as long as the value of A inputs is lower than the value of B inputs. The OUT output will be set to 0 (FALSE) when the value of A inputs is higher than or equal to the value of B inputs.
- **≥ Higher or equal:**
The OUT output will be 1 (TRUE) as long as the value of A inputs is higher than or equal to the value of B inputs. The OUT output will be set to 0 (FALSE) when the value of A inputs is lower than the value of B inputs.
- **> Higher:**
The OUT output will be 1 (TRUE) as long as the value of A inputs is higher than the value of B inputs. The OUT output will be set to 0 (FALSE) when the value of A inputs is lower than or equal to the value of B inputs.
- **≤ Lower oder Equal:**
The OUT output will be 1 (TRUE) as long as the value of A inputs is lower than or equal to the value of B inputs. The OUT output will be set to 0 (FALSE) when the value of A inputs is higher than the value of B inputs.
- **= Equal:**
The OUT output will be 1 (TRUE) as long as the value of A inputs is equal to the value of B inputs. The OUT output will be set to 0 (FALSE) when the value of A inputs is different from the value of B inputs.
- **!= Unequal:**
The OUT output will be 1 (TRUE) as long as the value of A inputs is different from the value of B inputs. The OUT output will be set to 0 (FALSE) when the value of A inputs is equal to the value of B inputs.

MEMORY OPERATORS

MEMORY OPERATORS can be used if you decide to save any data (TRUE or FALSE) from other project components.

Status changes are performed according to the truth tables shown for each operator.

D FLIP-FLOP (Max. 16 with UG 6911.10, 32 with UG 6911.12/080)

The D FLIP FLOP operator saves the previously set status on output Q according to the following truth table.

Preset	Clear	Ck	D	Q
1	0	X	X	1
0	1	X	X	0
1	1	X	X	0
0	0	L	X	Keep memory
0	0	Rising edge	1	1
0	0	Rising edge	0	0

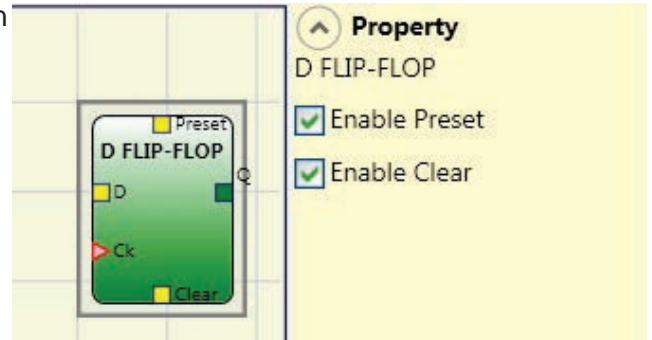

Parameters

Enable Preset:

If selected enables output Q to be set to 1 (TRUE).

Enable Clear:

If selected enables the saving process to be reset.

SR FLIP-FLOP

The SR FLIP FLOP operator saves the previously set status on output Q using Set and Reset according to the following truth table.

SET	RESET	Q
0	0	Keep memory
0	1	0
1	0	1
1	1	0

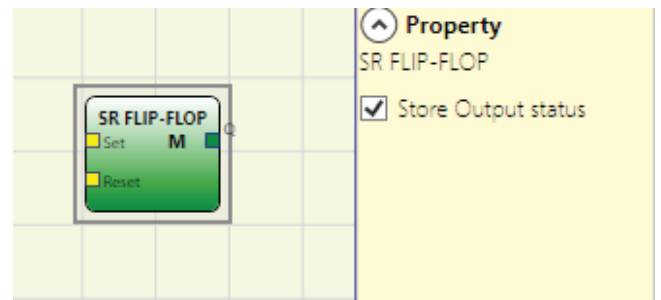



Parameters

Store output status:

If selected, it stores the output status of the Flip-flop in non-volatile memory every time it is changed. When the system is turned on, the last stored value is restored.

It is possible to have up to 8 Flip-Flops with output status storage that will be distinguishable by an 'M'.

 Some limitations to the use of this storage. The maximum time required for a single storage is estimated at 50 ms and the maximum number of possible storages is set at 100000.

 The total number of storages must not exceed the set limit, otherwise the operational life of the product will be reduced, and the frequency of such storages must be sufficiently low to enable them to be stored safely.

T FLIP-FLOP

This operator switches the Q output at each rising edge of the T input (Toggle).

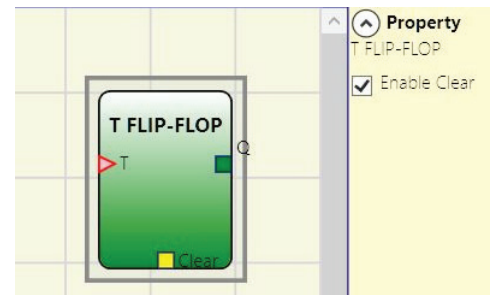

Parameters

Enable Clear:

If selected enables the saving process to be reset.

USER RESTART MANUAL (Max. 16 with UG 6911.10, 32 with UG 6911.12/080 with other RESTART operators)

The USER RESTART MANUAL operator saves the restart signal according to the following truth table.

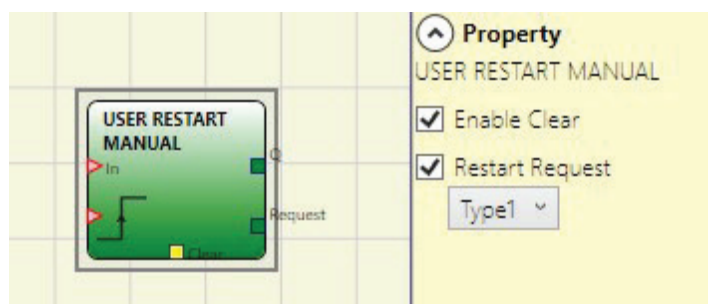

Clear	Restart	In	Q	Restart Request Type 1	Restart Request Type 2
1	X	X	0	0	1
X	X	0	0	0	1
0	0	1	Keep memory	1	Flashing 1Hz
0	Rising Edge	1	1	0	0

Parameters**Enable Clear:**

If selected, enables an input to reset the memorization.

Restart Request:

If selected, it enables an output that can be used to signal the possibility of performing the Restart. The behaviour can be of type 1 or type 2 (type 2 only with UG 6911.12/080), as represented in the truth table.

 In case of Restart Request Type 2 the output uses a system timer

USER RESTART MONITORED (Max. 16 with UG 6911.10, 32 with UG 6911.12/080 with other RESTART operators)

The USER RESTART MONITORED operator is used to save the restart signal according to the following truth table.

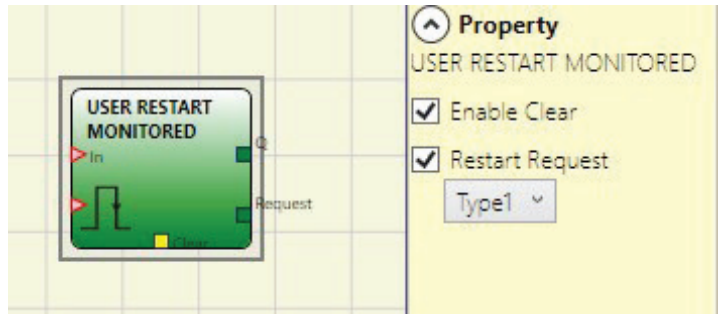

Clear	Restart	In	Q	Restart Request Type 1	Restart Request Type 2
1	X	X	0	0	1
X	X	0	0	0	1
0	0	1	Keep memory	1	Flashing 1 Hz
0		1	1	0	0

Parameters

Enable Clear:

If selected enables the saving process to be reset.

Restart Request:

If selected, it enables an output that can be used to signal the possibility of performing the Restart. The behaviour can be of type 1 or type 2 (type 2 only with UG 6911.12/080), as represented in the truth table.

 In case of Restart Request Type 2 the output uses a system timer

MACRO RESTART MANUAL (Max. 16 with UG 6911.10, 32 with UG 6911.12/080 with other RESTART operators)

The MACRO RESTART MANUAL operator is used to combine a logic gate chosen by the user with the Restart Manual functional block ("USER RESTART MANUAL") in accordance with the following truth table.

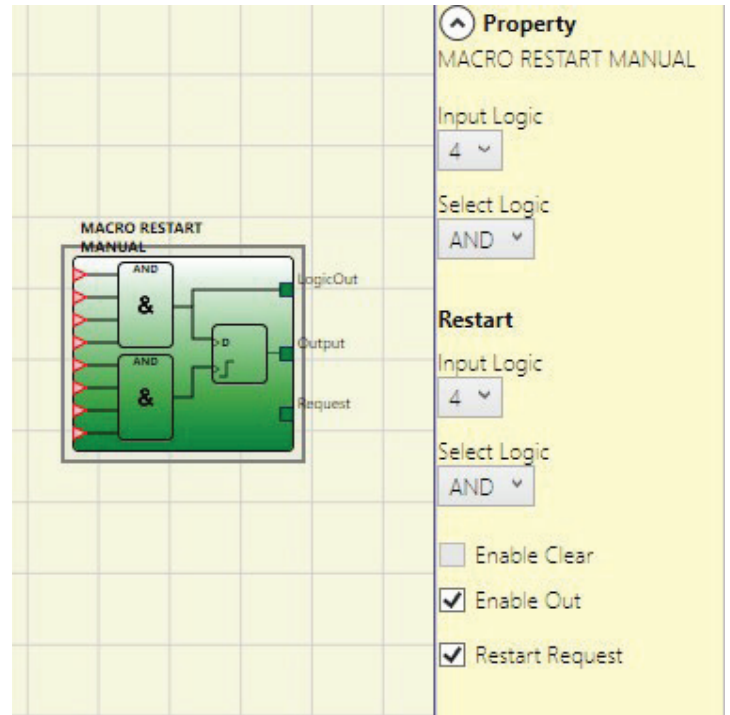

Clear	Restart Logic Out	Input Logic Out	Output	Restart Request
1	X	X	0	0
X	X	0	0	0
0	L	1	Keep memory	1
0	Rising edge	1	1	0

Parameters

Input Logic:

Enables the selection of the number of logic inputs (from 1 to 7). Selecting 1 the logic will not be considered.

Select Logic:

Enables the selection of one of the following types of operator AND, NAND, OR, NOR, XOR, XNOR

Restart Logic inputs:

Enables the selection of the number of inputs for restart logic (from 1 to 7). Selecting 1 the logic will not be considered.

Select Logic:

Enables the selection of one of the following types of operator AND, NAND, OR, NOR, XOR, XNOR

Enable Clear:

If selected enables the saving process to be reset.

Enable Out:

If selected activates an output with the result of the calculation done by the logic.

Restart Request

If selected, it enables an output that can be used to signal the possibility of performing the Restart. The behaviour is represented in the truth table.

MACRO RESTART MONITORED (Max. 16 with UG 6911.10, 32 with UG 6911.12/080 with other RESTART operators)

The MACRO RESTART MONITORED operator is used to combine a logic gate chosen by the user with the Restart Manual functional block ("USER RESTART MONITORED") in accordance with the following truth table.

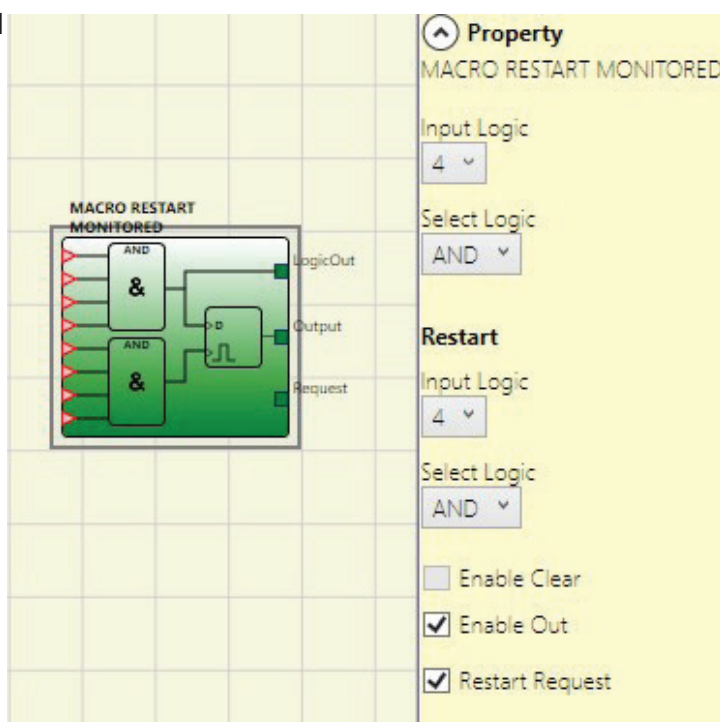

Clear	Restart Logic Out	Input Logic Out	Output	Restart Request
1	X	X	0	0
X	X	0	0	0
0	0	1	Keep memory	1
0		1	1	0

Parameters

Logic inputs:

Enables the selection of the number of logic inputs (from 1 to 7). Selecting 1 the logic will not be considered.

Select Logic:

Enables the selection of one of the following types of operator AND, NAND, OR, NOR, XOR, XNOR

Restart Logic inputs:

Enables the selection of the number of inputs for restart logic (from 1 to 7). Selecting 1 the logic will not be considered.

Select Logic:

Enables the selection of one of the following types of operator AND, NAND, OR, NOR, XOR, XNOR

Aktivierung Clear:

If selected enables the saving process to be reset.

Out aktivieren:

If selected activates an output with the result of the calculation done by the logic.

Restart Request:

If selected, it enables an output that can be used to signal the possibility of performing the Restart. The behaviour is represented in the truth table

PRE-RESET (Max. 32 with UG 6911.12/080 with other RESTART operators)

The PRE-RESET operator can be used when there is no possibility of having a single reset button in a position from which a complete visibility of the hazardous area is available.

In this case it is necessary to use a PRE-RESET button inside a zone of operation with a complete visibility and a RESET button outside the zone of operation to activate the Q output.

For both Pre-reset and Reset inputs the transition 0→1→0 is considered a valid signal. It is mandatory that the pulse 0→1→0 has a maximum duration of 5 s.

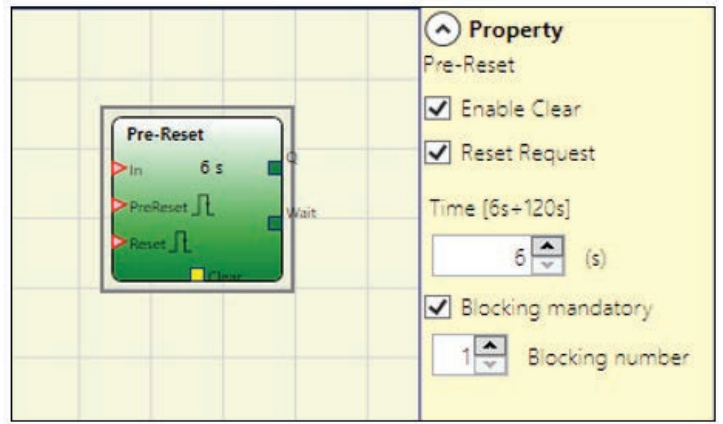

Parameters

Time:

The external reset is operative if pressed within a preset time configurable by the user in the range 6...120 s.

Blocking Mandatory:

If selected, the minimum number of interruptions (of the light curtain or similar) is 1 before the RESET signal can be activated. If you specify a BLOCKING NUMBER other than 1, this number corresponds to the maximum permissible number of interruptions. Blocking number: Blocking number has the range from 1 to 7.

Reset Request:

Enabling this item will make available an output from this operator. This signal is 1 from the PreReset signal transition to the end of the allowable time or to the next Reset signal transition.

Enable Clear:

If selected, enables an input to reset the memorization.

The behavior of the PRE-RESET operator is shown in the following timings:

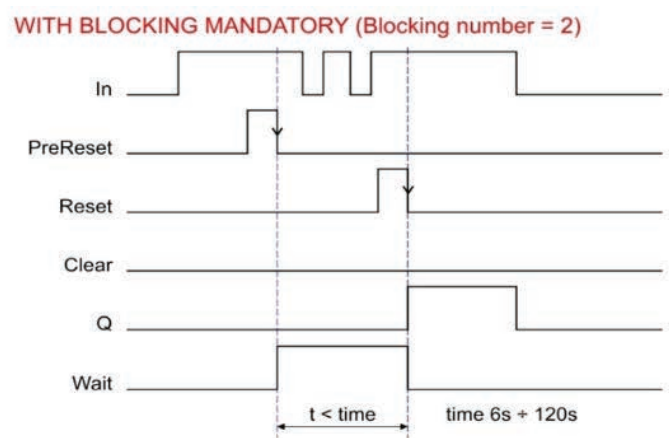
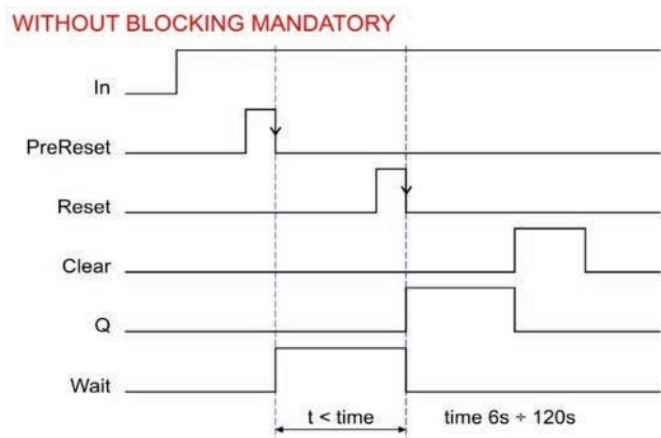

GUARD LOCK OPERATORS

GUARD LOCK (Max. 4 with UG 6911.10, 8 with UG 6911.12/080)

The GUARD LOCK is designed to control locking/unlocking of an **ELECTROMECHANICAL GUARD LOCK** in a variety of operating contexts.

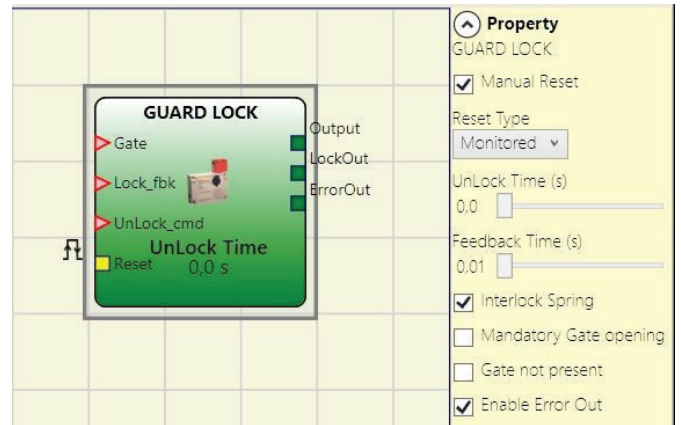

Parameters

Manual Reset:

There are two types of reset: Manual and Monitored. When Manual is selected the system only verifies the signal's transition from 0 to 1. If Monitored is selected the double transition from 0 to 1 and then back to 0 is verified



UnLock time (s):

The time that must pass between the **UnLock_cmd** input reaching and the real guard unlock (**LockOut output**).

- 0 ms ÷ 1 s Step 100 ms
- 1,5 s ÷ 10 s Step 0,5 s
- 15 s ÷ 25 s Step 5 s

Feedback Time (s):

Maximum delay accepted between **LockOut** output and **Lock_fbk** input (must be the one shown on the lock data sheet with appropriate gap decided by the operator)..

- 10 ms ÷ 100 s Step 10 ms
- 150 ms ÷ 1 s Step 50 ms
- 1.5 s ÷ 3 s Step 0.5 s

Interlock Spring:

The guard is locked passively and released actively, i.e. the mechanical force of the spring keeps it locked. The guard thus continues to be locked even when the power supply is disconnected.

Mandatory Gate opening:

Only with door opening and subsequent confirmation of input **GATE**, the cycle proceeds.

Gate not present:

If selected, enables configuration without Gate but only with **LOCK FEEDBACK** (feedback coil lock).

Enable Error Out:

This can be selected to enable a signal (Error Out) to indicate a lock malfunction. When Error Out = 1 (TRUE) there is a fault in the lock. (e.g. open door with guard lock locked, Feedback Time exceeding the maximum allowed, etc.).

Description of „GUARD LOCK“ operator inputs / outputs

Lock_Fbk input

The “Lock_fbk” input is used to detect the status (feedback) of the electromagnet that unlocks/locks the guard lock.

Electromechanical guard locks are unlocked/locked via an electric control that energizes/de-energizes an electromagnet. Its status (energized/de-energized) is indicated by appropriate contacts.

For example, the status of the electromagnet may be indicated by a normally open contact that is closed when the electromagnet is energized, as in the case shown in the following figure:

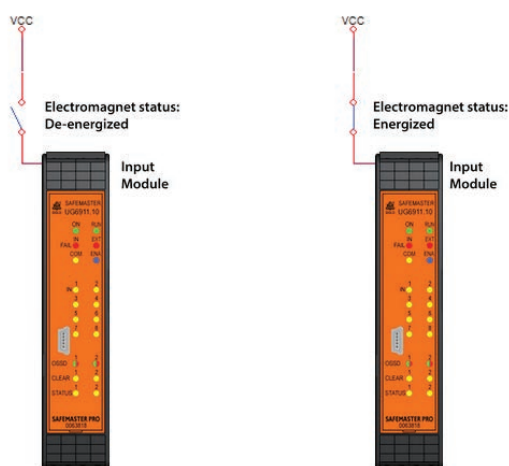

Example of feedback of the status of the electromagnet of a guard lock.

The signal received by the module is processed by the “Guard Lock” operator

GATE input

When the “Gate” input is selected, it detects (feedback) of the door / gate connected to the guard lock.

The status of the door/gate (GATE) is detected using specific contacts. For example, the status of the door/gate is closed, as shown in the following case.

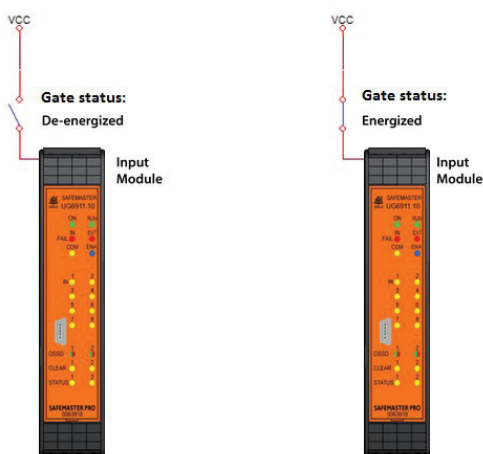

Example of feedback of the status of a door / gate connected to the guard lock.

The signal received by the module is processed by the “Guard Lock” operator.

UnLock_cmd input

The “UnLock_cmd” input detects the command sent by the user to lock or unlock the guard lock.

In detail:

- Request to unlock: the UnLock_cmd signal must be set to LL1
- Request to lock: the UnLock_cmd signal must be set to LL0

The command signal may be sent via a key, for example

Output output

This signal indicates the information shown in the table below, depending on its value.

	Value	MEANING
Output	LL1	- Door / Gate closed - Guard lock locked
Output	LL0	- User request to unlock the guard lock - Error condition

LockOut output

This signal controls the guard lock electromagnet and can assume LL0 and LL1 value.

ErrorOut putput

If enabled, when this signal is set to LL1 it indicates an error in the control of the guard lock. It is set to LL0 when no errors have occurred.

Operation: General description

The “**Guard Lock**” operator analyses consistency between the status of the “**Unlock_cmd**” signal, the status of a door/gate (E-GATE), if present, via the “Gate” signal, and the status of the electromagnet via the “**Lock_fbk**” signal. The main output, “**Output**”, is LL1 (TRUE) when the guard lock is closed and locked.

Operation in the "no Gate" mode

In this case, the user must select the “Gate not present” parameter.

The **Lock_Fbk** input must always be connected to a “LOCK FEEDBACK” input element (see the LOCK FEEDBACK section) that verifies the status of the guard lock electromagnet.

The **UnLock_cmd** input can be connected freely in the diagram and determines the request to unlock the guard lock (when set to LL1).

The **Output** signal is LL1 (TRUE) if the safety guard is locked. When an unlock command is applied to the **UnLock_cmd** input, the **Output** signal is set to LL0 and the guard lock is unlocked via the **LockOut** signal.

The **Output** signal can also be set to LL0 (FALSE) when error conditions are present (e.g. Feedback Time exceeding the maximum allowed, etc.).

When the **UnLock_cmd** signal is detected, the **LockOut** signal unlocks the guard lock after the UnLock Time, a parameter that can be defined by the user.

The time after which the electromagnet is activated depends entirely on the technical/physical characteristics of the specific device and may therefore vary according to the type of guard lock used. Thus, since the **LockOut** signal controls the activation of this device, the status of the **Lock_Fbk** feedback signal will change at different times, depending on the type of guard lock. This variability can be avoided by changing the value of the Feedback Time parameter, which is the maximum delay accepted by the “Guard_Lock” operator before the **Lock_Fbk** signal switches status following a request to activate the electromagnet. Clearly, the following condition must be met:

$$\text{Feedback Time} \geq \text{Electromagnet activation time}$$

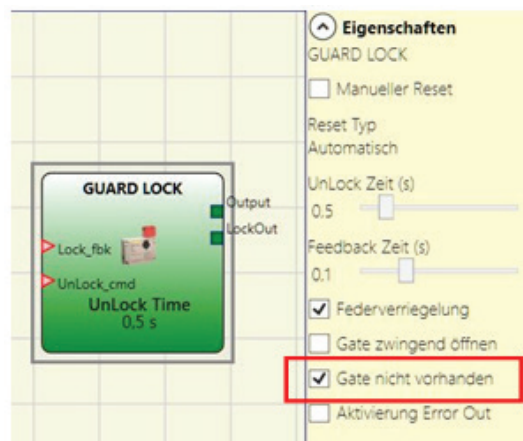

Operation in the "no Gate" mode

Example of operation in the "no Gate" mode

In this example the user unlocks the guard lock with the "SWITCH" block. The "LockOut" signal controls a "STATUS" block output that controls the guard lock electromagnet, the status of which is detected by the **Lock_Fbk** input via the "LOCK FEEDBACK" input block.

"Output1" indicates the status of the operations.

The guard lock used in the example continues to be locked when the electromagnet is not energized. Therefore the "Interlock spring" option must be selected.

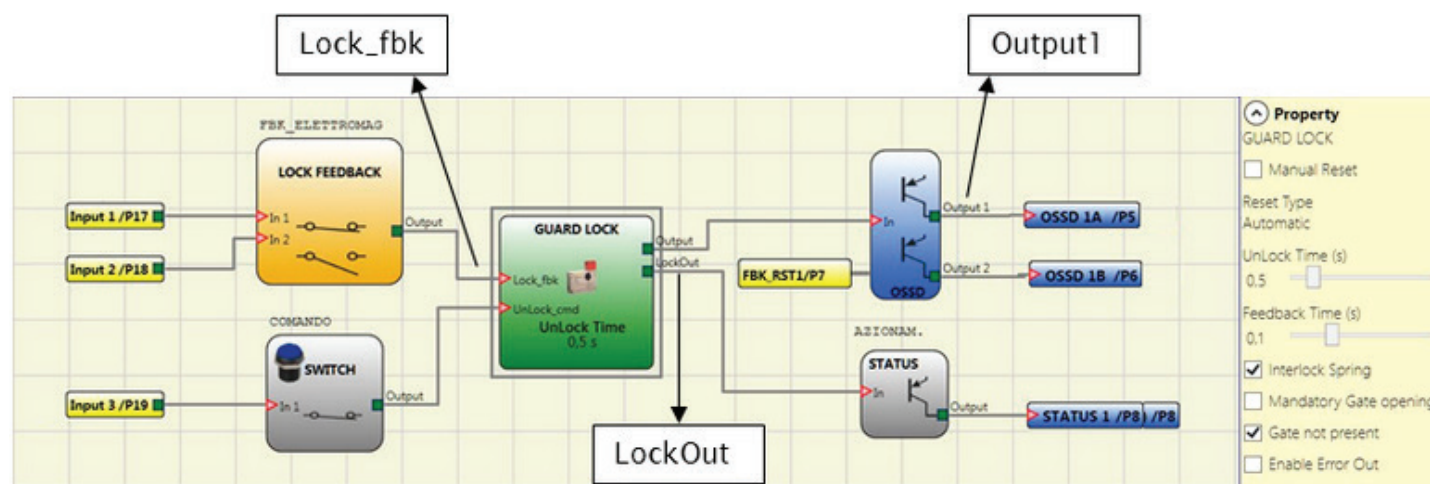

Example of operation in the no Gate mode



The Guard Lock operator parameters are shown on the right. On the left there is an example of an application diagram. The electromagnet feedback consists of two contacts, one normally closed and one normally open. When the electromagnet is energized the two contacts switch status.

The example shows the traces relative to the operation. These are described in detail below:

1. At this time the user requests to unlock the guard lock. The "COMMAND" signal switches from LL0 to LL1, and the "OUTPUT1" signal switches from LL1 to LL0.
2. At this time the electromagnet is activated with a delay of "Unlock Time", after the command is sent. This delay has been set to 0.5 seconds. The "ACTIV." signal switches from LL0 to LL1.
3. At this time the electromagnet is actually activated, 95 ms after the command was sent. This delay is due to the technical characteristics of the electromagnet. In any case, 95ms is less than 100ms ("Feedback Time") and so no errors have occurred.
4. At this time the user releases the unlock command and the "COMMAND" signal switches from LL1 to LL90 as does the "ACTIV." activation signal.
5. At this time the electromagnet is actually deactivated, approx. 95ms after the command was sent due to the technical characteristics of the device. The guard lock is now locked.
6. As soon as the "Guard Lock" operator detects that the guard lock is locked, the "OUTPUT1" signal switches to LL1.

Operation in the "no Gate" mode

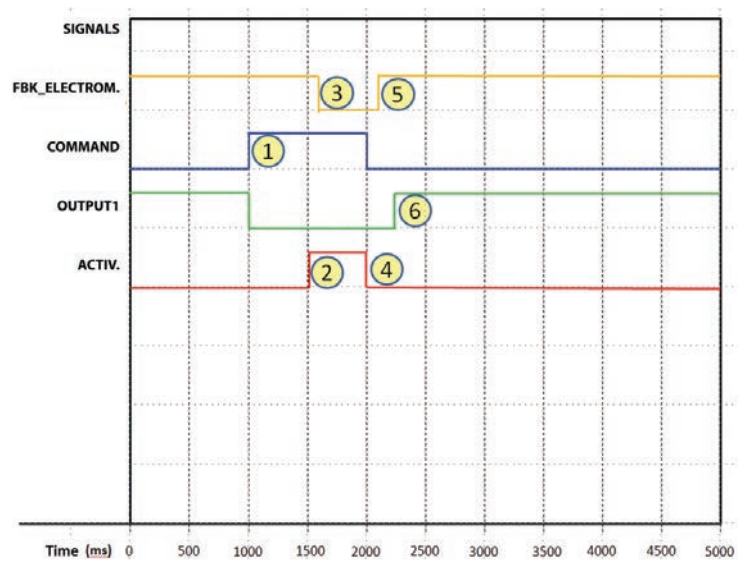

Traces relative to "Guard Lock" block operation in the no Gate mode

Operation in the "with Gate" mode

In this case, the user must **NOT** select the "Gate not present" parameter. The **Gate** input must always be connected to an "E-GATE" input element (see the E-GATE (safety gate device) section) that verifies the status of the door/gate.

The **Lock_Fbk** input must always be connected to a "LOCK FEEDBACK" input element (see the LOCK FEEDBACK section) that verifies the status of the guard lock electromagnet.

The **UnLock_cmd** input can be connected freely in the diagram and determines the request to unlock the guard lock (when set to LL1).

The **Output** signal is LL1 (TRUE) if the safety guard is closed and locked. When an unlock command is applied to the **UnLock_cmd** input, the **Output** signal is set to LL0 and the guard lock is unlocked via the **LockOut** signal. The **Output** signal can also be set to LL0 (FALSE) when error conditions are present (e.g. open door with guard lock locked, Feedback Time exceeding the maximum allowed, etc.)

Ab dem Moment, in dem der Freigabebefehl **UnLock_cmd** erfasst wird, gibt das **LockOut**-Signal die Verriegelung nach einem Timeraum frei, der einer vom Benutzer als Parameters eingebbaren UnLock-Time entspricht.

When the **UnLock_cmd** signal is detected, the **LockOut** signal unlocks the guard lock after the UnLock Time, a parameter that can be defined by the user.

The time after which the electromagnet is activated depends entirely on the technical/physical characteristics of the specific device and may therefore vary according to the type of guard lock used. Thus, since the **LockOut** signal controls the activation of this device, the status of the **Lock_Fbk** feedback signal will change at different times, depending on the type of guard lock. This variability can be avoided by changing the value of the Feedback Time parameter, which is the maximum delay accepted by the "Guard_Lock" operator before the **Lock_Fbk** signal switches status following a request to activate the electromagnet. Clearly, the following condition must be met:

$$\text{Feedback Time} \geq \text{Electromagnet activation time}$$



Operation in the "with Gate" mode

Example of operation in the "with Gate" mode

In this example the user unlocks the guard lock with the "SWITCH" block. The "LockOut" signal controls a "STATUS" output that controls the guard lock electromagnet, the status of which is detected by the **Lock_Fbk** input via the "LOCK FEEDBACK" input block.

"Output1" indicates the status of the operations.

The status of the safety gate is monitored by the "Gate" input via the "E-GATE" input.

The guard lock used in the example continues to be locked when the electromagnet is not energized. Therefore the "Interlock spring" option must be selected.

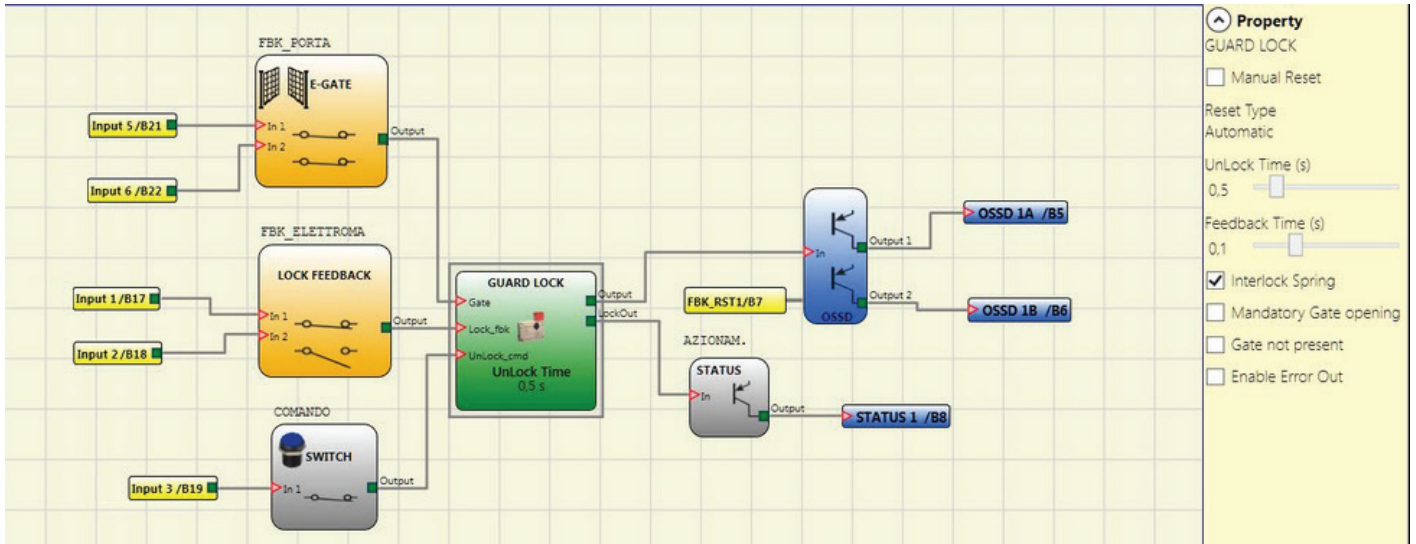

Example of operation in the with Gate mode



The Guard Lock operator parameters are shown on the right. On the left there is an example of an application diagram. The electromagnet feedback consists of two contacts, one normally closed and one normally open. When the electromagnet is energized the two contacts switch status. The gate feedback consists of two normally closed contacts.

The example shows the traces relative to the operation. These are described in detail below:

1. At this time the user requests to unlock the guard lock. The "COMMAND" signal switches from LL0 to LL1, and the "OUTPUT1" signal switches from LL1 to LL0.
2. At this time the electromagnet is activated with a delay of "Unlock Time", after the command is sent. This delay has been set to 0.5 seconds. The "ACTIV." signal switches from LL0 to LL1.
3. At this time the electromagnet is actually activated, 95 ms after the command was sent. This delay is due to the technical characteristics of the electromagnet. In any case, 95ms is less than 100ms ("Feedback Time") and so no errors have occurred.
4. At this time the guard is unlocked and the user opens the gate, the FBK_GATE signal switches from LL1 to LL0.
5. At this time the user closes the gate and the FBK_GATE signal thus switches from LL0 to LL1.
6. At this time the user releases the unlock gate command. The "Guard Lock" detects the gate closed condition, via the FBK_GATE signal, and sends a command to lock the guard lock. The "ACTIV." signal switches from LL1 to LL0.
7. At this time the electromagnet is actually deactivated, approx. 95ms after the command was sent due to the technical characteristics of the device. The guard lock is now locked.
8. As soon as the "Guard Lock" operator detects that the guard lock is locked and the gate is closed, the "OUTPUT1" signal switches to LL1.

Operation in the "with Gate" mode

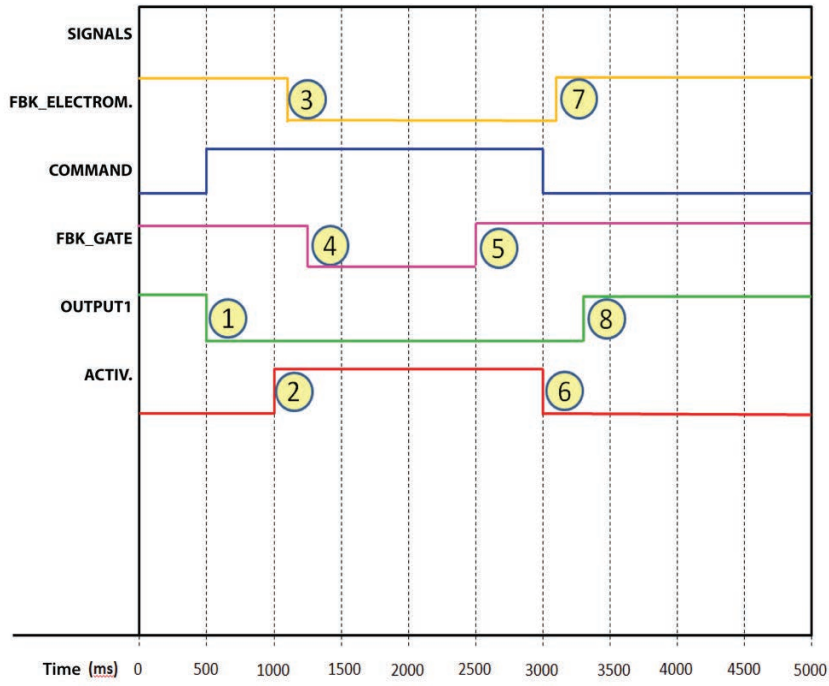

Traces relative to "Guard Lock" block operation in the with Gate mode

Operation in the “Mandatory Gate Opening” mode

In this case, the user must **NOT** select the “Gate not present” parameter and must select the “Mandatory Gate opening” parameter

The Gate input must always be connected to an “E-GATE” input element (see the E-GATE (safety gate device) section) that verifies the status of the door/gate.

Note: In this operating mode the “Gate” input must confirm the opening of the gate.

The **Lock_Fbk** input must always be connected to a “LOCK FEEDBACK” input element (see the LOCK FEEDBACK section) that verifies the status of the guard lock electromagnet.

The **UnLock_cmd** input can be connected freely in the diagram and determines the request to unlock the guard lock (when set to LL1).

The **Output** signal is LL1 (TRUE) if the safety guard is closed and locked. When an unlock command is applied to the **UnLock_cmd** input, the **Output** signal is set to LL0 and the guard lock is unlocked via the **LockOut** signal.

The **Output** signal can also be set to LL0 (FALSE) when error conditions are present (e.g. open door with guard lock locked, Feedback Time exceeding the maximum allowed, etc.).

When the **UnLock_cmd** signal is detected, the **LockOut** signal unlocks the guard lock after the UnLock Time, a parameter that can be defined by the user.

The time after which the electromagnet is activated depends entirely on the technical/physical characteristics of the specific device and may therefore vary according to the type of guard lock used. Thus, since the **LockOut** signal controls the activation of this device, the status of the **Lock_Fbk** feedback signal will change at different times, depending on the type of guard lock. This variability can be avoided by changing the value of the Feedback Time parameter, which is the maximum delay accepted by the “Guard_Lock” operator before the **Lock_Fbk** signal switches status following a request to activate the electromagnet. Clearly, the following condition must be met:

$$\text{Feedback Time} \geq \text{Electromagnet activation time}$$

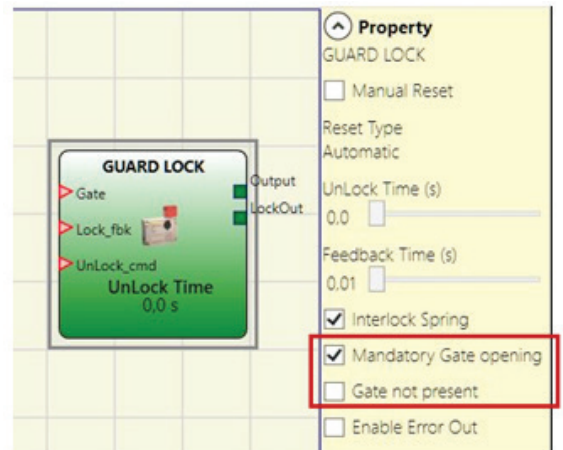

Operation in the “Mandatory Gate Opening” mode

Example of operation in the “Mandatory Gate Opening” mode

In this example the user unlocks the guard lock with the “SWITCH” block. The “LockOut” signal controls a “STATUS” output that controls the guard lock electromagnet, the status of which is detected by the **Lock_Fbk** input via the “LOCK FEEDBACK” input block.

“Output1” indicates the status of the operations.

The status of the safety gate is monitored by the “Gate” input via the “E-GATE” input block, the “Mandatory Gate opening” parameter is selected.

The guard lock used in the example continues to be locked when the electromagnet is not energized. Therefore the “Interlock spring” option must be selected.

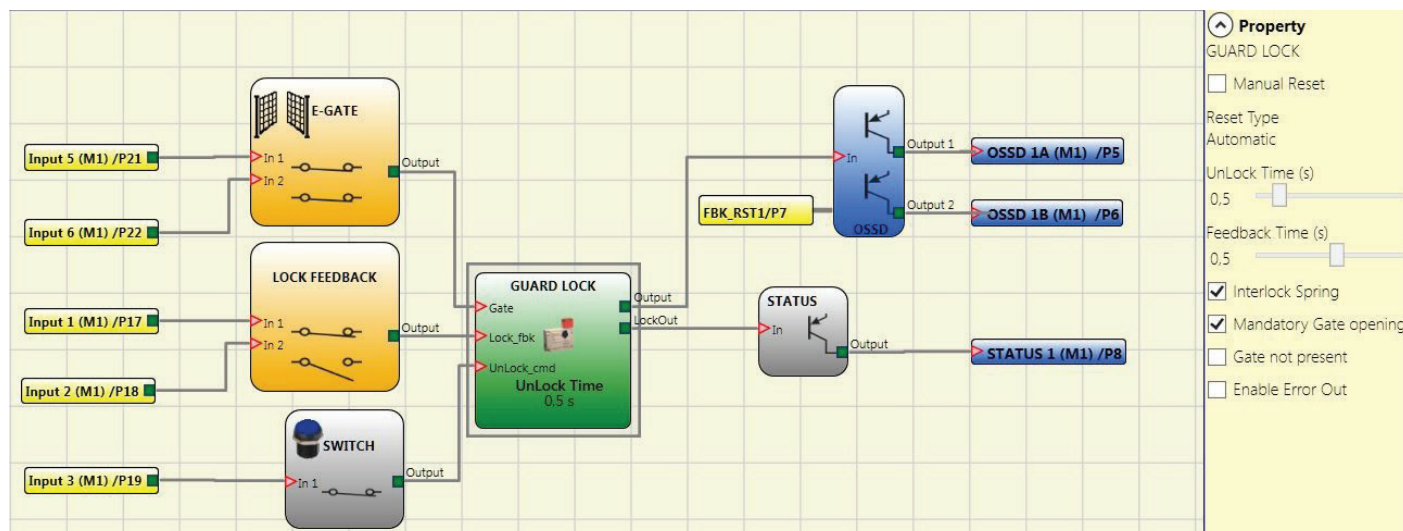

Example of operation in the Mandatory Gate Opening mode

Info The Guard Lock operator parameters are shown on the right. On the left there is an example of an application diagram. The electromagnet feedback consists of two contacts, one normally closed and one normally open. When the electromagnet is energized the two contacts switch status. The gate feedback consists of two normally closed contacts.

The example shows the traces relative to the operation. These are described in detail below:

1. At this time the user requests to unlock the guard lock. The “COMMAND” signal switches from LL0 to LL1, and the “OUTPUT1” signal switches from LL1 to LL0.
2. At this time the electromagnet is activated with a delay of “Unlock Time”, after the command is sent. This delay has been set to 0.5 seconds. The “ACTIV.” signal switches from LL0 to LL1.
3. At this time the electromagnet is actually activated, 95 ms after the command was sent. This delay is due to the technical characteristics of the electromagnet. In any case, 95ms is less than 100ms (“Feedback Time”) and so no errors have occurred.
4. At this time the guard is unlocked and the user opens the gate, the FBK_GATE signal switches from LL1 to LL0.
5. At this time the user closes the gate and the FBK_GATE signal thus switches from LL0 to LL1.
6. At this time the user releases the unlock gate command. The “Guard Lock” detects the gate closed condition, via the FBK_GATE signal, and sends a command to lock the guard lock. The “ACTIV.” signal switches from LL1 to LL0.
7. At this time the electromagnet is actually deactivated, approx. 95ms after the command was sent due to the technical characteristics of the device. The guard lock is now locked.
8. As soon as the “Guard Lock” operator detects that the guard lock is locked and the gate is closed, the “OUTPUT1” signal switches to LL1.

Operation in the “Mandatory Gate Opening” mode

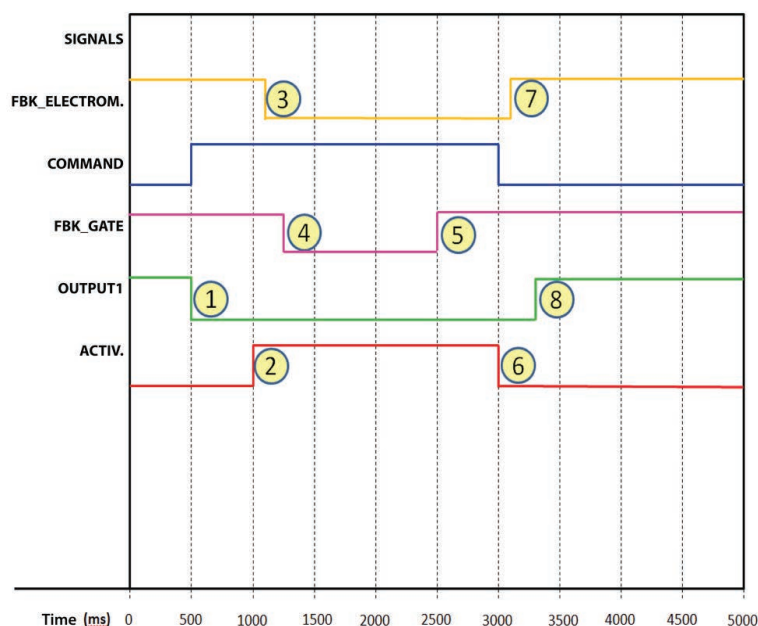

Traces relative to “Guard Lock” block operation in the “Mandatory gate opening” mode

In “Mandatory gate opening” mode, the “Guard_lock” operator indicates an error condition if it does not detect that the gate has been opened following a request to unlock the guard lock. This concept is highlighted in the figure below (figure 59). In this case, the “Enable Error out” option has been selected in the diagram in figure 57, so that the error is shown in the graph.

As previously described, the operator requests unlocking of the guard lock, but the door is never opened, and this condition is indicated by the “FBK_GATE” signal, which stays at LL1. Thus, when the guard lock unlocking/locking cycle ends, at time “E”, the “Guard_Lock” operator switches the status of the “ERROR” signal from LL0 to LL1.

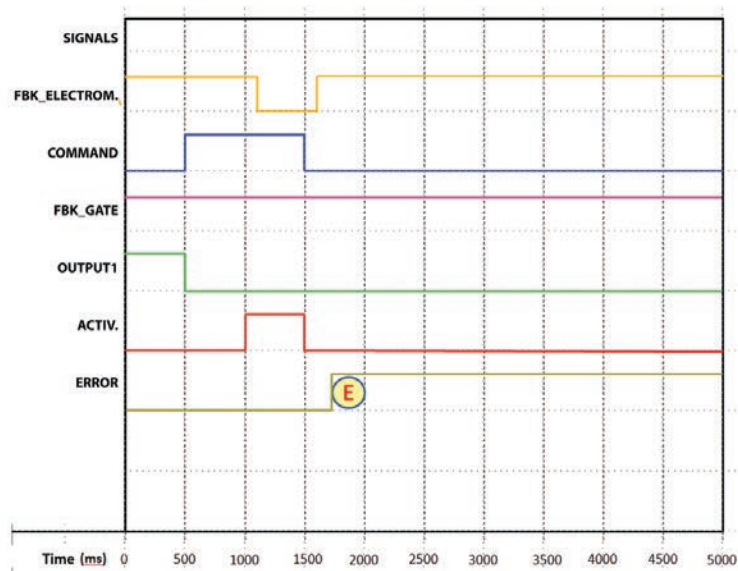

Example of possible error in the “Mandatory Gate Opening” mode.

In this case the error condition is generated because the gate has not been opened, even though a request has been sent to unlock/lock the guard lock.

COUNTER OPERATORS

COUNTER operator is a pulse counter that sets output Q to 1 (TRUE) as soon as the desired count is reached.

COUNTER (Max. number 16)

The operator COUNTER is a pulse counter.

Es gibt drei Betriebsarten:

- 1) AUTOMATIC
- 2) MANUAL
- 3) MANUAL/AUTOMATIC

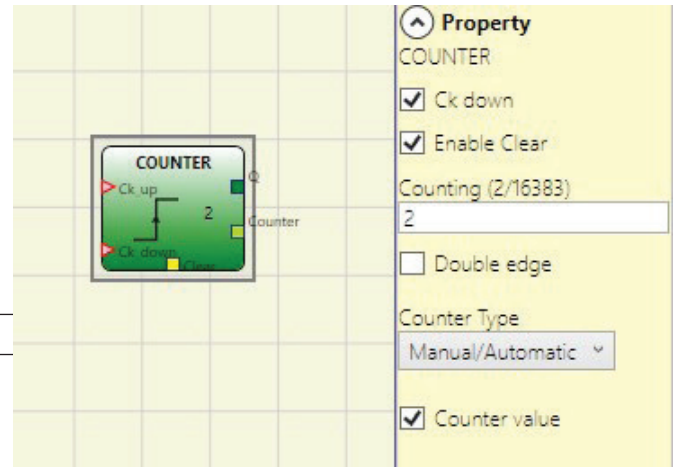

Parameters

Ck down:

Enables counting down.

Enable Clear:

If selected this enables the request to clear in order to restart the counter setting output Q to 0 (FALSE). It also offers the possibility of enabling or not enabling (Automatic Enable) automatic operation with manual reset. If this is not selected operation is automatic. Once the set count is reached output Q is set to 1 (TRUE) and stays in this condition for two internal cycles after which it is reset.

Two-way (Double edge):

If selected it enables counting on both the rising and falling edges

Counter Type:

If selected, it allows the current counter value to be extracted from the delay block. This output can be sent as input to one or more COUNTER COMPARATOR blocks. Counter value is 6 for all examples:

- 1) The counter generates a pulse duration equal to 2 x Tcycle (indicated in the REPORT) as soon as the set count is reached. If the CLEAR pin is not enabled this is the default mode..

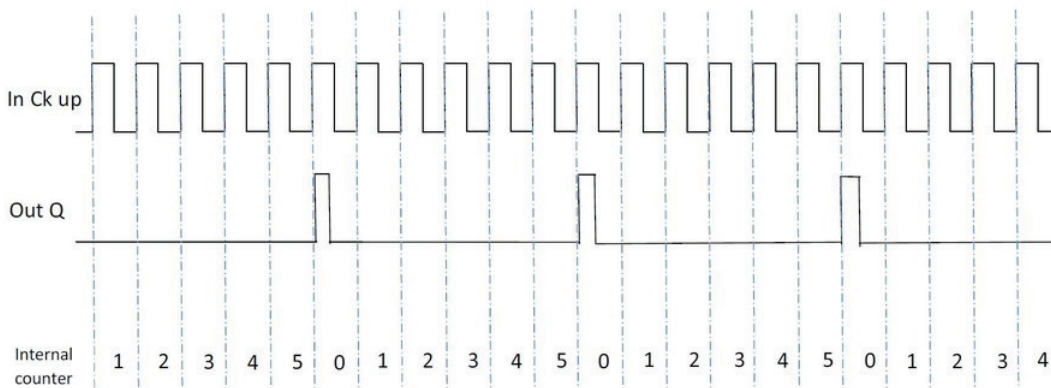

COUNTER (Max. number 16)

2) The counter leads to 1 (TRUE) the output Q as soon as it reaches the set count. The output Q goes to 0 (FALSE) when the signal CLEAR is activated.

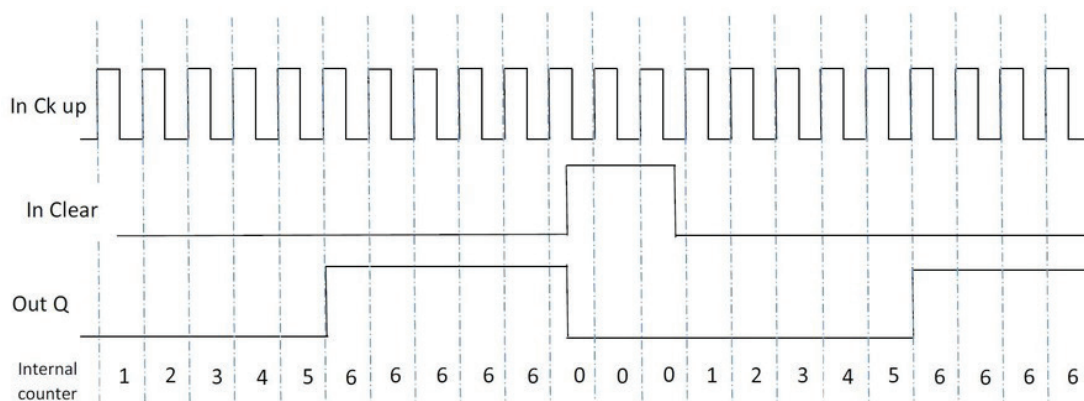

3) The counter generates a pulse duration equal to the system response time as soon as the set count is reached. If the CLEAR signal is activated, the internal count goes back to 0.

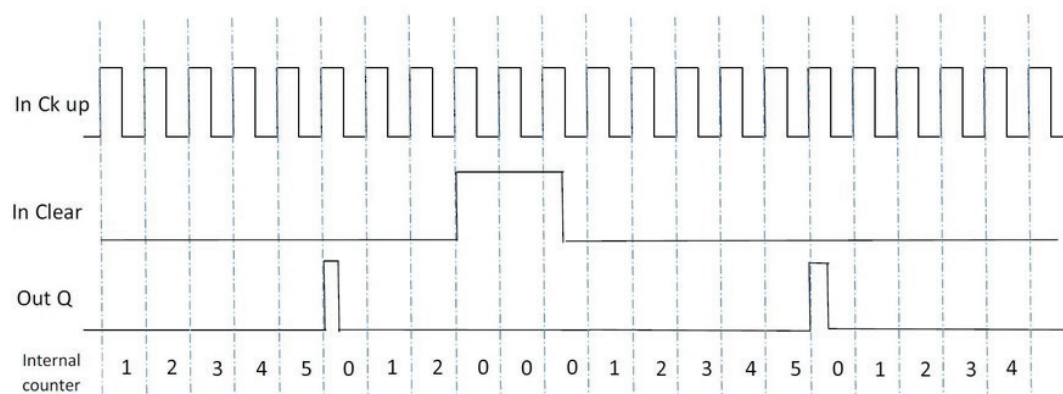

COUNTER COMPARATOR

The operator COUNTER COMPARATOR enables to compare the value of the COUNTER connected with the set threshold value. The OUT output will be 0 (FALSE) as long as the COUNTER value is lower than the threshold value. The OUT output will be set to 1 (TRUE) for COUNTER values equal to or higher than the threshold value.

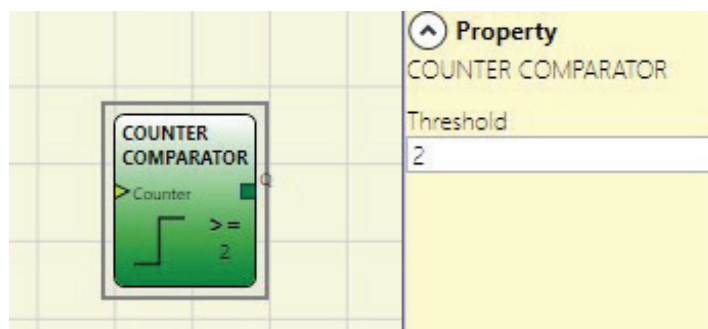

Attention: The COUNTER COMPARATOR operator can only be connected to the Counter value of a COUNTER operator. Multiple COUNTER COMPARATOR can be also connected to a single COUNTER operator

TIMER OPERATORS (MAX. 32 WITH UG 6911.10; 48 WITH UG 6911.12/080)

TIMER operators allow you to generate a signal (TRUE or FALSE) for a user-definable period.

CLOCKING

The CLOCKING operator generates a clock signal output with the set period if the IN input is 1 (TRUE). Clocking has up to 7 inputs to control output Duty Cycle.

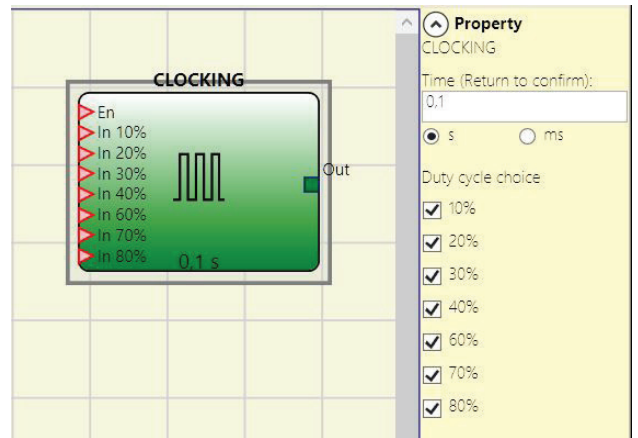

Parameters

Time:

The period can be set to between 10 ms and 1098,3 s

Scale:

The user can choose two different scales for the time T to be set

- 10 ms...60 s, step 10 ms
- 60,1 s...1098,3 s step 100 ms

Duty cycle choice:

Up to 7 inputs can be selected for 7 different output signal duty cycles. Depending on the active input, the OUT clock signal has its corresponding duty cycle. EN input must always be high level (TRUE).

Refer to the table below to check operator functioning:

EN	10%	20%	30%	40%	50%	60%	70%	80%	OUT
0	0	0	0	0	0	0	0	0	0
1	0	0	0	0	0	0	0	0	50%
1	1	0	0	0	0	0	0	0	10%
1	0	1	0	0	0	0	0	0	20%
1	0	0	1	0	0	-	0	0	30%
1	0	0	0	1	0	-	0	0	40%
1	0	0	0	0	1	-	0	0	50%
1	0	0	0	0	0	1	0	0	60%
1	0	0	0	0	0	0	1	0	70%
1	0	0	0	0	0	0	0	1	80%
1	1	0	0	0	0	0	0	1	90%

 The circuit upstream of the CLOCKING operator must guarantee the presence of a single input signal other than the EN enable (apart from the pair 10 % 80 %).

 The presence of the EN input together with > 1 high level (TRUE) inputs, generates an output signal with a duty cycle = 50 %.

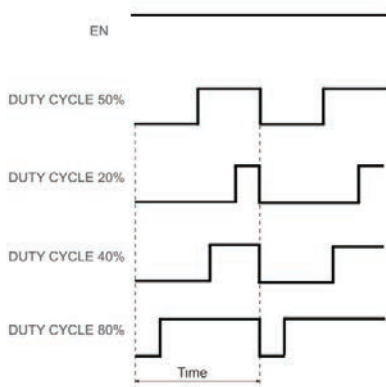

MONOSTABLE

The MONOSTABLE operator generates a level 1 (TRUE) output activated by the rising edge of the input and remains in this condition for the set time.

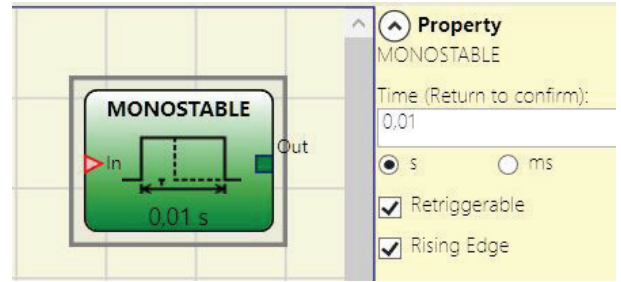

Parameters

Time:

The period can be set to between 10 ms and 1098,3 s

Scale:

The user can choose two different scales for the time T to be set

- 10 ms...60 s, step 10 ms
- 60,1 s...1098,3 s step 100 ms

Retriggerable:

If selected the time is reset each time the input status changes.

Rising edge:

If selected, the output is set to 1 (TRUE) on the input signal's rising edge where it remains for the set time, which can be extended for as long as the input stays at 1 (TRUE).

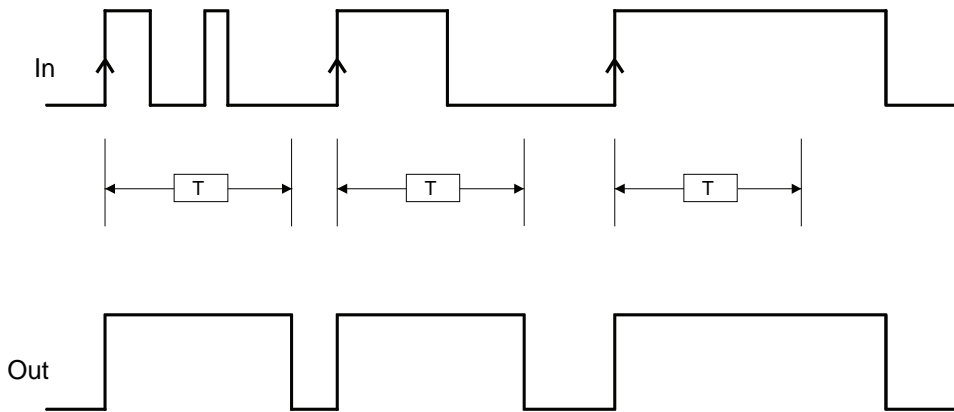

If not selected the logic is inverted, the output is set to 0 (FALSE) on the input signal's falling edge, where it remains for the set time, which can be extended for as long as the input stays at 0 (FALSE).

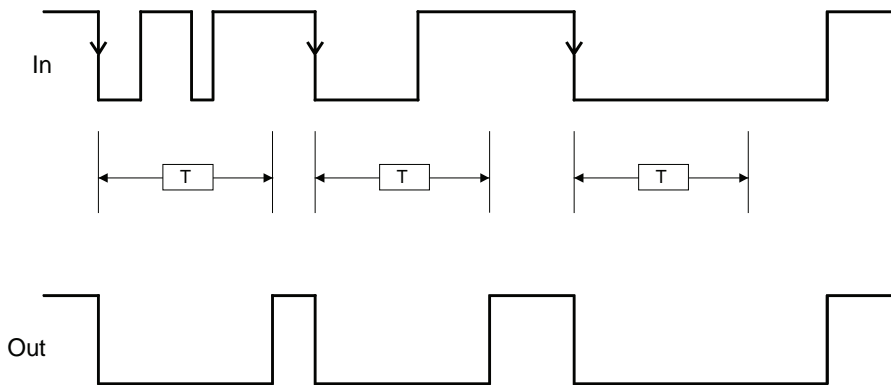

MONOSTABLE B

The MONOSTABLE_B operator generates a level 1 (TRUE) output activated by the rising/falling edge of the input and remains in this condition for the set time

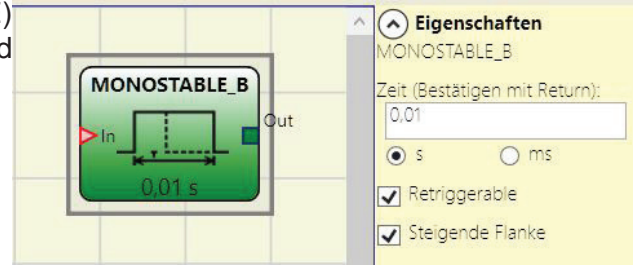

Parameters

Time:

The period can be set to between 10 ms and 1098,3 s

Scale:

The user can choose two different scales for the time T to be set

- 10 ms...60 s, step 10 ms
- 60,1 s...1098,3 s step 100 ms

Retriggerable:

If selected the time is reset each time the input status changes

Rising edge:

If selected, provides a level 1 (TRUE) in the OUT output if a rising edge is detected on the IN input.

If not selected, the logic is inverted, the OUT output is set to 0 (FALSE) on the IN signal's falling edge, where it remains for the set time.

 Unlike the MONOSTABLE operator, the output of MONOSTABLE_B does not maintain a level 1 (TRUE) for a time which exceeds the set period t.

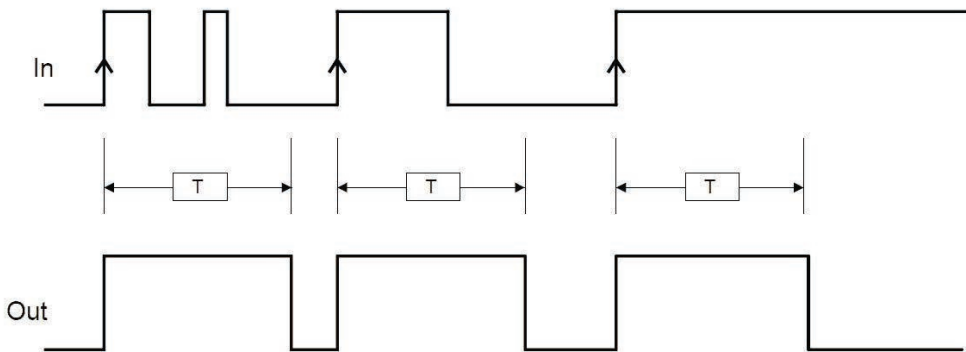

Rising edge

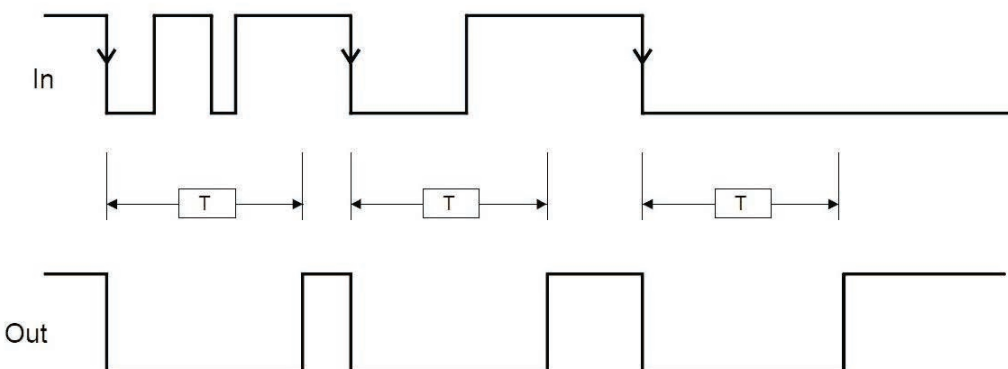

Falling edge

PASSING MAKE CONTACT

In the PASSING MAKE CONTACT operator the output follows the signal on the input. However, if this is 1 (TRUE) for longer than the set time, the output changes to 0 (FALSE).

When there is an input falling edge, the timer is cleared

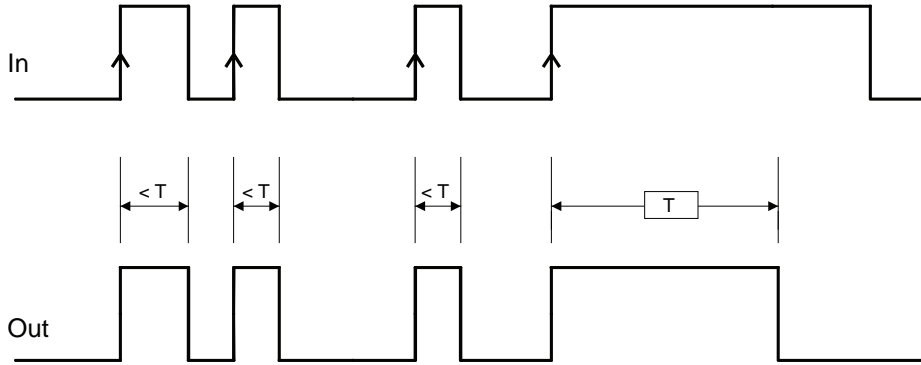
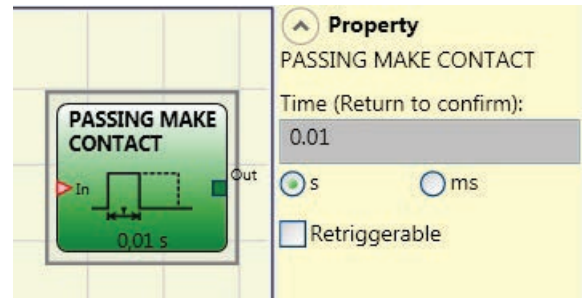

Parameters

Time:

The period can be set to between 10 ms and 1098,3 s

Scale:

The user can choose two different scales for the time T to be set

- 10 ms...60 s, step 10 ms
- 60,1 s...1098,3 s step 100 ms

Retriggerable:

If selected the time is not reset when there is an input falling edge. The output stays 1 (TRUE) for all the selected time. When there is a new input rising edge, the timer restarts again.

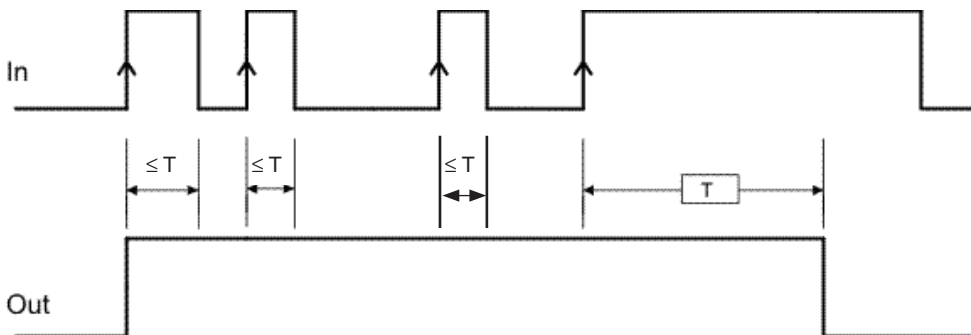

DELAY

The DELAY operator applies a delay to a signal by setting the output to 1 (TRUE) after the set time, against a change in the level of the input signal.



Parameters

Time:

The period can be set to between 10 ms and 1098.3 s

Scale:

The user can choose two different scales for the time T to be set

- 10 ms...60 s, step 10 ms
- 60,1 s...1098,3 s step 100 ms

Retriggerable:

If selected the time is reset each time the input status changes

Rising edge:

If selected, the delay starts on the input signal's rising edge at the end of which the output changes to 1 (TRUE) if the input is 1 (TRUE) where it remains for as long as the input stays at 1 (TRUE).

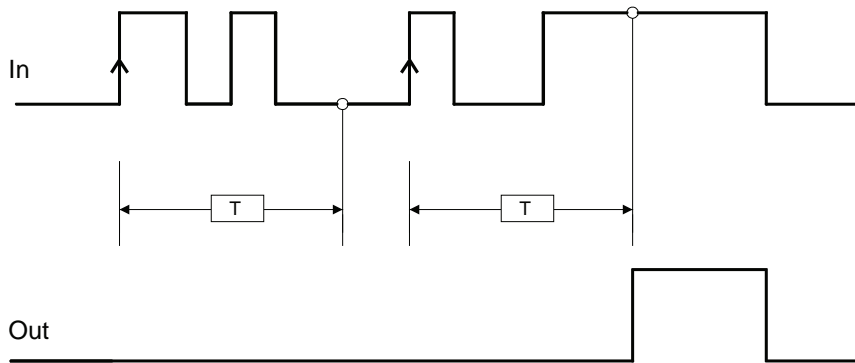

If not selected the logic is inverted, the output is set to 1 (TRUE) on the input signal's falling edge, the delay starts on the input signal's falling edge, at the end of the set time the output changes to 0 (FALSE) if the input is 0 (FALSE) otherwise it remains 1 TRUE.

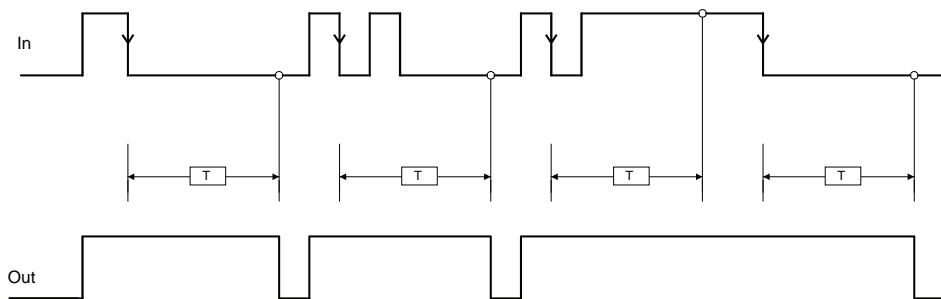

DELAY LINE

The operator DELAY LINE applies a delay to a signal by setting the OUT output to 0 after the set time, set at a falling edge of the IN signal.

If IN returns to 1 before the end of the set time, the OUT output still generates an LLO impulse lasting approximately twice the response time and delayed by the set time.

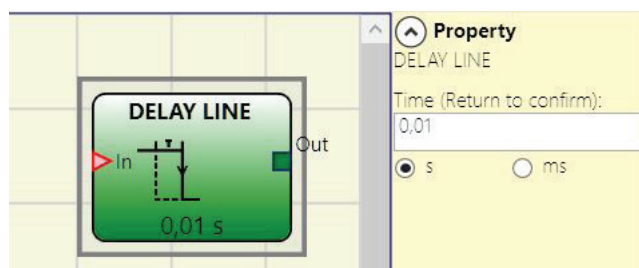

**Parameters**

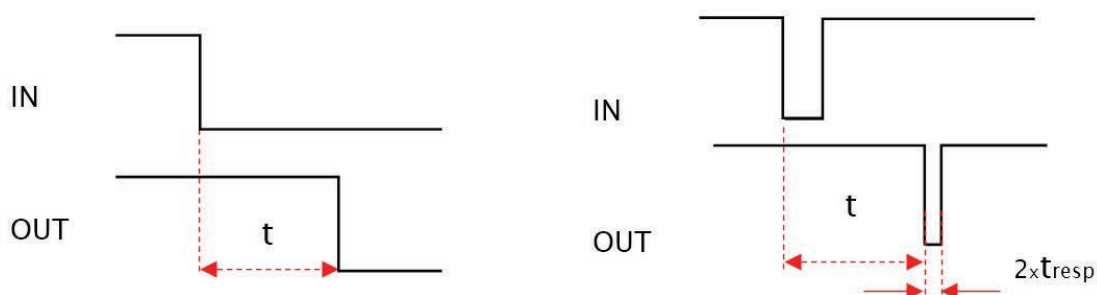
Time:
Enables the insertion of the desired delay time by selecting the preferred unit of measurement. The delay can be set to between 10 ms and 1098.3 s.

**Scale:**

The user can choose two different scales for the time T to be set

- 10 ms...60 s, step 10 ms
- 60,1 s...1098,3 s step 100 ms

-  Unlike the DELAY operator, the DELAY LINE operator does not filter interruptions in the IN input which are shorter than the set time
-  This operator is recommended when using delayed OSSD (the OSSD must be programmed with RESTART MANUAL).

LONG DELAY

The LONG DELAY operator allows to apply a delay (up to more than 15 hours) to a signal bringing to 1 (TRUE) the Out output after the set time, in case of a level variation of the signal on the In input.

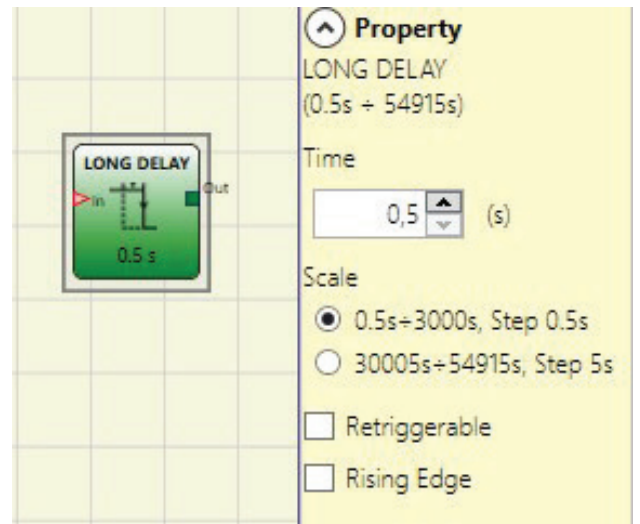

Parameters

Time:

The delay can be set from 0.5 s to 54915 s

Scale:

The user can choose two different scales for the time T to be set

- 0.5 s ... 3000 s, step 0.5 s
- 3005 s ... 54915 s step 5 s

Rising edge:

If selected, the delay starts on the input signal's rising edge at the end of which the output changes to 1 (TRUE) if the input is 1 (TRUE) where it remains for as long as the input stays at 1 (TRUE).

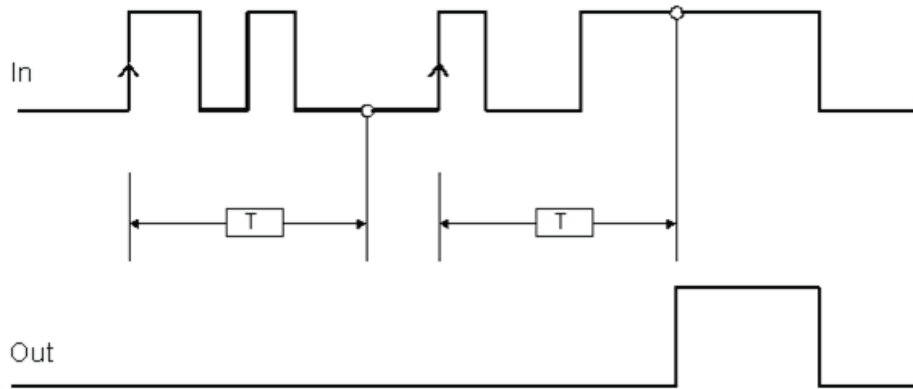

If not selected the logic is inverted, the output is set to 1 (TRUE) on the input signal's rising edge, the delay starts on the input signal's falling edge, at the end of the set time the output changes to 0 (FALSE) if the input is 0 (FALSE) otherwise it remains 1 TRUE.

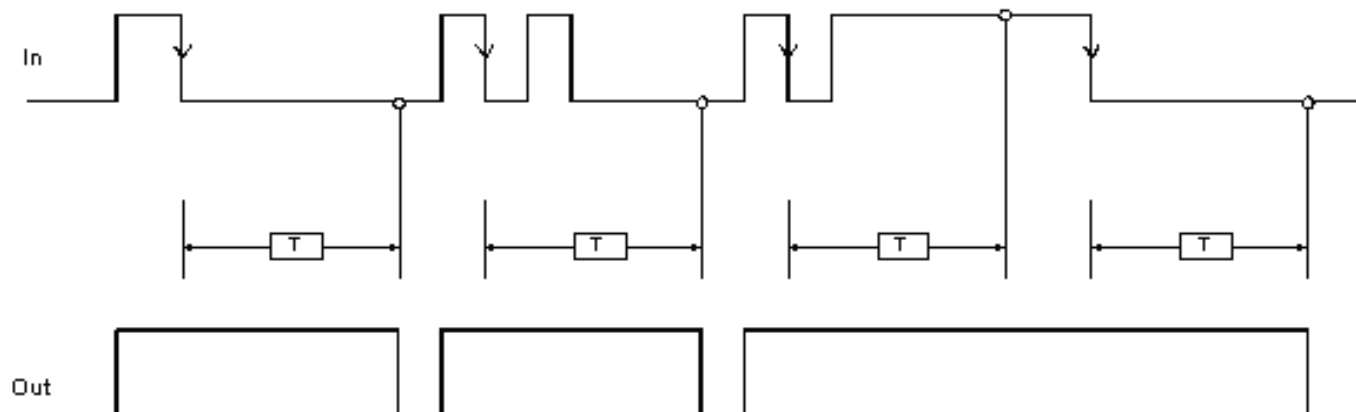

Retriggerable:

If selected the time is resetted every time the input status changes.

Timer-Value:

If selected, it allows to extract from the delay block the punctual value of the timer. This output can be sent as input to a DELAY COMPARATOR block.

DELAY COMPARATOR

This operator enables to compare the value of the LONG DELAY timer connected with the set threshold value. The OUT output will be 0 (FALSE) as long as the timer value is lower than the threshold value. The OUT output will be set to 1 (TRUE) for Timer values equal to or higher than the threshold value

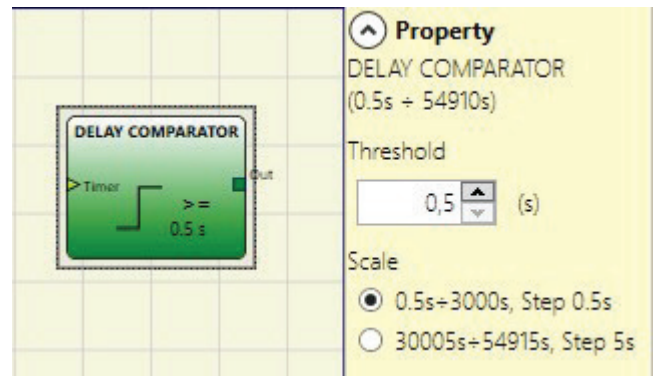
**Parameters**Threshold:

The threshold can be set from 0,5 s to 54910 s.

Scale:

The user can choose two different scales for the time T to be set

- 0.5 s ... 3000 s, step 0.5 s
- 3005 s ... 54915 s step 5 s



Attention: The Delay Comparator operator can only be connected to the Timer value output of a LONG DELAY operator. Multiple DELAY COMPARATORS can be connected to each LONG DELAY operator.

LONG DELAY LINE

The operator LONG DELAY LINE inserts a delay to a signal bringing the OUT output to 0 after the time set in the event of an IN signal descent.

If before the set time has elapsed IN returns to 1, the OUT output still generates a 0 level pulse, which lasts approximately 2 times the response time and is delayed by the set time

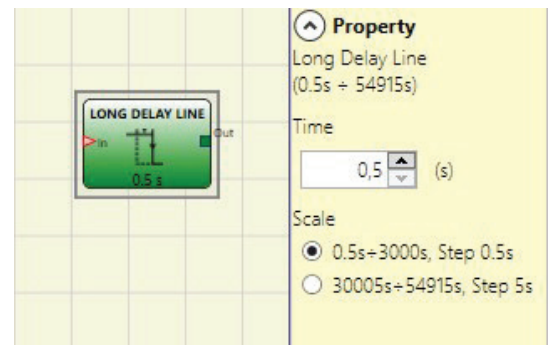

Parameters

Time:

It enables to select the desired delay time. The delay can be set from 0.5 s to 54915 s

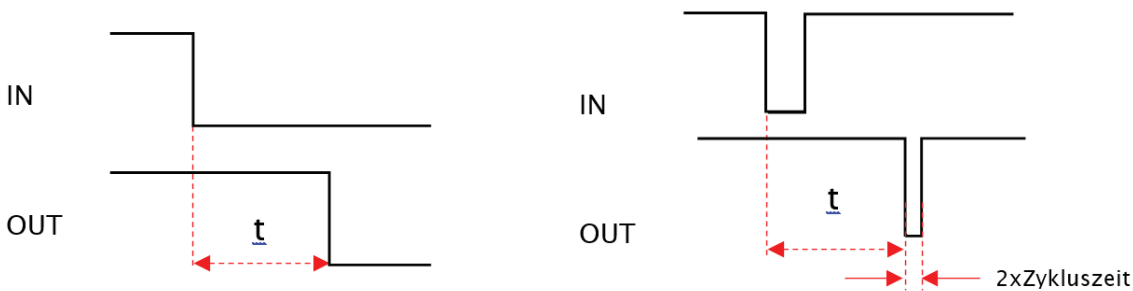

Scale:

The user can choose two different scales for the time T to be set

- 0.5 s ... 3000 s, step 0.5 s
- 3005 s ... 54915 s step 5 s

 Unlike the DELAY operator, the LONG DELAY LINE operator does not filter out any interruptions to the IN input that are shorter than the set time.

 This operator is indicated when using delayed OSSDs (the OSSD must be programmed with MANUAL RESTART).

MUTING OPERATORS (MAX. 4 WITH UG 6911.10, AND 8 WITH UG 6911.12/080)**The MUTING function**

The Muting function generates a temporary, automatic interruption of safety device operation in order to permit normal transit of material through the guarded opening. In other words, when the system recognizes the material and distinguishes between this and any operator (in a potentially dangerous situation), it is enabled to bypass the safety device temporarily, allowing the material to pass through the guarded opening.

„Concurrent“ MUTING (MUTING "Con")

The activation of the Muting function occurs following interruption of the sensors S1 and S2 beam (the order does not matter) within a time range from 2s and 5s decided by the operator (or S3 and S4 with material that is moving in the direction opposite).

The MUTING operator with "Concurrent" logic performs muting of the input signal through sensor inputs S1, S2, S3 and S4.

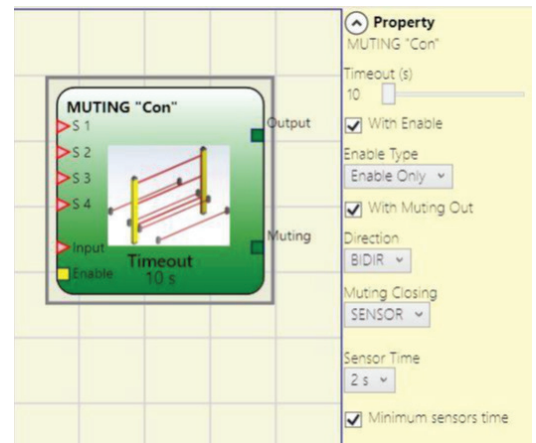

Preliminary condition: The Muting cycle can only start if all the sensors are 0 (FALSE) and inputs are 1 (TRUE) (barrier free).

Parameters**Timeout (s):**

Sets the time, between 10 secs and unlimited, within which the Muting cycle must end. If the cycle is not complete at the end of this time, Muting is immediately discontinued.

With Enable:

If selected it enables the possibility of enabling or not enabling the Muting function. Otherwise the Muting function is always enabled.

There are two Enable modes: Enable/Disable and Enable Only. If Enable/Disable is selected the Muting cycle cannot start if Enable is fixed at 1 (TRUE) or 0 (FALSE) but is only activated with a rising edge. To disable muting, set Enable to 0 (FALSE). In this mode the falling edge disables Muting regardless of the condition. If Enable Only is selected Muting cannot be disabled but Enable must be set to 0 (FALSE) in order to enable a new rising edge for the next Muting cycle

Direction:

The order in which the sensors are occupied can be set. If set to BIDIR they can be occupied in both directions, from S1&S2 to S3&S4 and from S3&S4 to S1&S2, if set to UP they can be occupied from S1&S2 to S3&S4 and if set to DOWN from S3&S4 to S1&S2.

Muting closing:

There are two types, CURTAIN and SENSOR. If you select CURTAIN muting closes when the input signal rises, if you select SENSOR it closes when the third sensor has been cleared.

Parameters**Select CURTAIN**

S1	S2	Input	S3	S4	Muting
0	0	1	0	0	0
1	0	1	0	0	0
1	1	1	0	0	1
1	1	X	0	0	1
1	1	X	1	1	1
0	0	0	1	1	1
0	0	1	1	1	0
0	0	1	0	0	0

Select SENSOR

S1	S2	Input	S3	S4	Muting
0	0	1	0	0	0
1	0	1	0	0	0
1	1	1	0	0	1
1	1	X	0	0	1
1	1	X	1	1	1
0	0	0	1	1	1
0	0	1	1	1	1
0	0	1	0	1	0
0	0	1	0	0	0

Blind Time:

Only with Muting Close=Curtain, blind time is enabled if you know that after the complete transition of the pallet (muting cycle close) some protruding objects could still occupy the light curtain and send the input to 0 (FALSE). During blind time the input remains 1 (TRUE). Blind Time can range from 250 ms to 1 s.

Sensor-Time:

A difference of between 2 and 5 seconds can be set for activating the sensors.

Minimum sensors time:

If selected, allows the activation of Muting cycle only if a time >150ms elaps between the activation of sensor 1 and sensor 2, or sensor 3 and 4 respectively.

„L“ MUTING

The activation of the Muting function occurs following interruption of the sensors S1 and S2 beam (the order does not matter) within a time range from 2 s and 5 s decided by the operator. The state of Muting ends after the liberation of the guarded opening.

The MUTING operator with “L” logic performs muting of the input signal through sensor inputs S1 and S2.

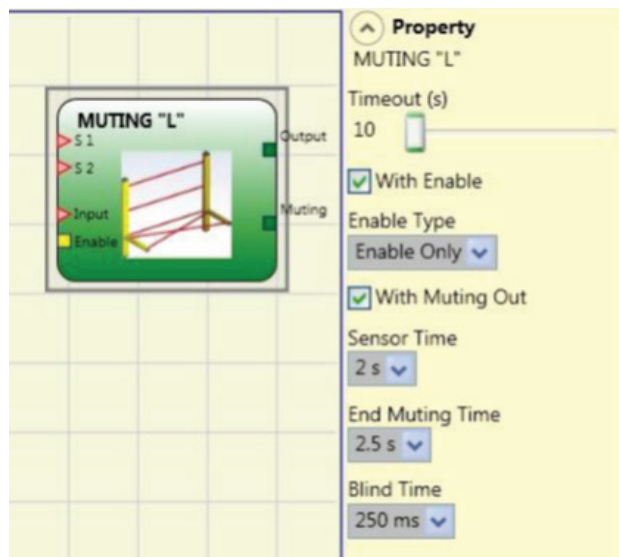

Preliminary condition: The Muting cycle can only start if S1 and S2 are 0 (FALSE) and the inputs are 1 (TRUE) (barrier free).

Parameters**Timeout (s):**

Sets the time, between 10 secs and unlimited, within which the Muting cycle must end. If the cycle is not complete at the end of this time, Muting is immediately discontinued.

With Enable:

If selected it enables the possibility of enabling or not enabling the Muting function. Otherwise the Muting function is always enabled.

There are two Enable modes: Enable/Disable and Enable Only. If Enable/Disable is selected the Muting cycle cannot start if Enable is fixed at 1 (TRUE) or 0 (FALSE) but is only activated with a rising edge. To disable muting, set Enable to 0 (FALSE). In this mode the falling edge disables Muting regardless of the condition. If Enable Only is selected Muting cannot be disabled but Enable must be set to 0 (FALSE) in order to enable a new rising edge for the next Muting cycle.

Sensor-Time:

A difference of between 2 and 5 seconds can be set for activating the sensors.

End Muting Time:

Sets the muting falling time, from 2.5 to 6 seconds, after the second sensor has been cleared.

Blind Time:

Enabled if you know that after the complete transition of the pallet (muting cycle close) some protruding objects could still occupy the light curtain and send the input to 0 (FALSE). During blind time the input remains 1 (TRUE). Blind Time can range from 250 ms to 1 s

„Sequential“ MUTING

The activation of the Muting function occurs following sequential interruption of the sensors S1 and S2, subsequently S3 and S4 sensors (without time limit). If the pallet proceeds in the opposite direction the correct sequence is: S4, S3, S2, S1.

The MUTING operator with "Sequential" logic performs muting of the input signal through sensor inputs S1, S2, S3 and S4.

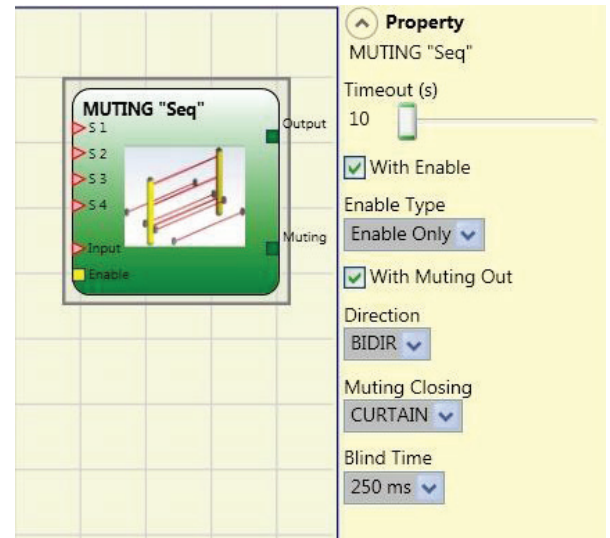

Property
MUTING "Seq"

Timeout (s)
10

With Enable
Enable Type
Enable Only

With Muting Out
Direction
BIDIR

Muting Closing
CURTAIN

Blind Time
250 ms



Info Preliminary condition: The Muting cycle can only start if all the sensors are 0 (FALSE) and the inputs are 1 (TRUE) (barrier free).

Parameters

Timeout (s):

) Sets the time, between 10 secs and unlimited, within which the Muting cycle must end. If the cycle is not complete at the end of this time, Muting is immediately discontinued.

With Enable:

If selected it enables the possibility of enabling or not enabling the Muting function. Otherwise the Muting function is always enabled.

There are two Enable modes: Enable/Disable and Enable Only. If Enable/Disable is selected the Muting cycle cannot start if Enable is fixed at 1 (TRUE) or 0 (FALSE) but is only activated with a rising edge. To disable muting, set Enable to 0 (FALSE). In this mode the falling edge disables Muting regardless of the condition. If Enable Only is selected Muting cannot be disabled but Enable must be set to 0 (FALSE) in order to enable a new rising edge for the next Muting cycle.

Direction:

The order in which the sensors are occupied can be set. If set to BIDIR they can be occupied in both directions, from S1 to S4 and from S4 to S1, if set to UP they can be occupied from S1 to S4 and if set to DOWN from S4 to S1.

Muting Closing:

There are two types, CURTAIN and SENSOR. If you select CURTAIN muting closes when the input signal rises, if you select SENSOR it closes when the last sensor has been cleared.

Parameters**Select CURTAIN**

S1	S2	Input	S3	S4	Muting
0	0	1	0	0	0
1	0	1	0	0	0
1	1	1	0	0	1
1	1	X	0	0	1
1	1	X	1	0	1
1	1	X	1	1	1
0	1	X	1	1	1
0	0	0	1	1	1
0	0	1	1	1	0
0	0	1	0	1	0
0	0	1	0	0	0

Select SENSOR

S1	S2	Input	S3	S4	Muting
0	0	1	0	0	0
1	0	1	0	0	0
1	1	1	0	0	1
1	1	X	0	0	1
1	1	X	1	0	1
1	1	X	1	1	1
0	1	X	1	1	1
0	0	0	1	1	1
0	0	1	1	1	1
0	0	1	0	1	0
0	0	1	0	0	0

Blind Time:

Only with Muting Close=Curtain, blind time is enabled if you know that after the complete transition of the pallet (muting cycle close) some protruding objects could still occupy the light curtain and send the input to 0 (FALSE). During blind time the input remains 1 (TRUE). Blind Time can range from 250 ms to 1 s.

„T“ MUTING

The activation of the Muting function occurs following interruption of the sensors S1 and S2 beam (the order does not matter) within a time range from 2s and 5s decided by the operator. The state of Muting ends after the liberation of at least one of the two sensors.

The MUTING operator with “T” logic performs muting of the input signal through sensor inputs S1 and S2.

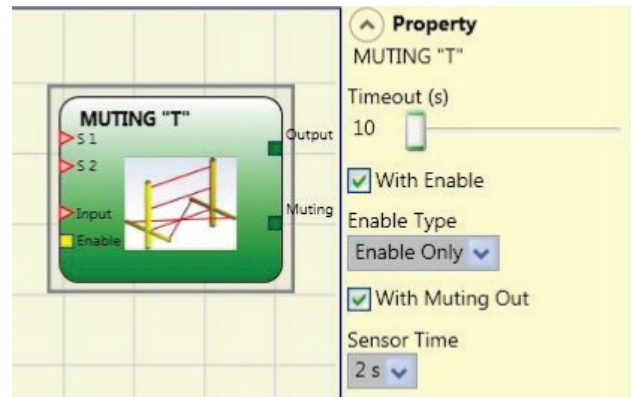

Preliminary condition: The Muting cycle can only start if S1 and S2 are 0 (FALSE) and the inputs are 1 (TRUE) (barrier free).

Parameters

Timeout (s):

Sets the time, between 10 s and unlimited, within which the Muting cycle must end. If the cycle is not complete at the end of this time, Muting is immediately discontinued.

With Enable:

If selected it enables the possibility of enabling or not enabling the Muting function. Otherwise the Muting function is always enabled.

There are two Enable modes: Enable/Disable and Enable Only. If Enable/Disable is selected the Muting cycle cannot start if Enable is fixed at 1 (TRUE) or 0 (FALSE) but is only activated with a rising edge. To disable muting, set Enable to 0 (FALSE). In this mode the falling edge disables Muting regardless of the condition. If Enable Only is selected Muting cannot be disabled but Enable must be set to 0 (FALSE) in order to enable a new rising edge for the next Muting cycle

Sensor-Time:

A difference of between 2 and 5 seconds can be set for activating the sensors.

MUTING OVERRIDE

The OVERRIDE function must be used when the machine stops due to incorrect Muting activation sequences with the material obstructing the guarded opening. This function activates the OSSD outputs making it possible to remove the material that is obstructing the guarded opening.

The operator must be connected after the Muting operator (Muting OUTPUT directly to the Override INPUT). The operator permits override of the directly connected Muting Input.

Override can be activated only if Muting is not active (INPUT=0) and at least one Muting sensor is occupied (or the light curtain is occupied).

Override ends when the light curtain and sensors are cleared and the OverOut switches to logical "0" (FALSE). Override can be set to pulsed or maintained action mode.

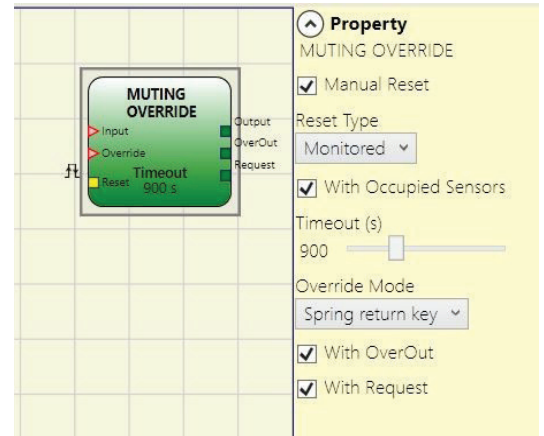

Override with maintained action control.

This function must be activated maintaining the Override command active (OVERRIDE=1) during all subsequent operations. However, a new Override can be activated, de-activating and re-activating the command. When the light curtain and sensors are cleared (gap free) or on expiry of the timeout, Override ends without the need for further commands.

Override with pulsed action.

This function is enabled activating the Override command (OVERRIDE=1).

Override ends when the light curtain and sensors are cleared (gap free) or on expiry of the timeout. The function can be restarted only if the Override command is re-activated (OVERRIDE=1)

Manual Reset:

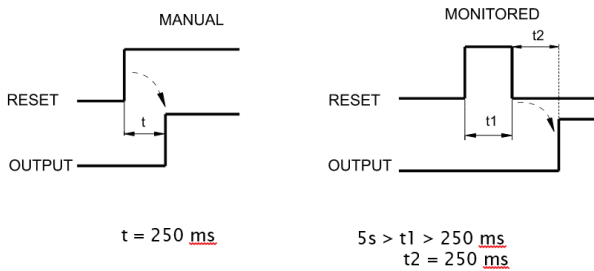

- Should the INPUT be active (TRUE), the reset enables the output of the function block.
- Should the INPUT be not active (FALSE), the output of the function block follows the OVERRIDE request.

There are two types of reset: Manual and Monitored. When Manual is selected the system only verifies the signal's transition from 0 to 1. If Monitored is selected the double transition from 0 to 1 and then back to 0 is verified.



With sensors occupied:

- Must be selected with "T" sequential, simultaneous muting.
- With "L" muting, must not be selected.

	Otherwise, a Warning is displayed in the compilation phase and in the report.
	The user must adopt additional safety measures during the Override phase.

Parameters

„With sensors occupied selected“	Sensor occupied	Light curtain occupied	Input	Override Request	Override Output
X	X	-	0	1	1
-	-	X	0	1	1
	X	-	0	1	1
	X	X	0	1	1

Conditions to be checked for activation of Override

Timeout (s):

Used to set the time, between 10 sec and infinity, by which the Override function must end.

Override Mode:

Used to configure the type of Override (pulsed or maintained action):

- Spring return key:

This function must be activated maintaining the Override command active (OVERRIDE=1) during all subsequent operations. However, a new Override can be activated, de-activating and re-activating the command. When the light curtain and sensors are cleared (gap free) or on expiry of the timeout, Override ends without the need for further commands.

- Enable with key:

This function is enabled activating the Override command (OVERRIDE=1).

Override ends when the light curtain and sensors are cleared (gap free) or on expiry of the timeout. The function can be restarted only if the Override command is re-activated (OVERRIDE=1)

Mit OverOut:

Used to activate an Override active output (active when high).

With Request:

Used to activate an output (active when high) indicating that the Override function can be activated.

MISCELLANY (SPECIAL FUNCTION BLOCKS)

SERIAL OUTPUT (MAX. 4 WITH UG 6911.10, 8 WITH UG 6911.12/080)

The Serial Output operator outputs the status of up to 8 inputs, serializing the information

Operating principles

This operator outputs the status of all the connected inputs in two different ways:

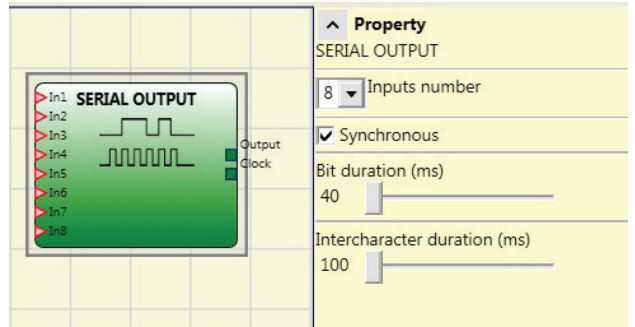

Asynchrone Methode der Serialisierung:

- 1) The status of the line in the idle condition is 1 (TRUE);
- 2) The start data transmission signal is 1 bit = (FALSE);
- 3) Transmission of n bits with the status of the connected inputs encoded using the Manchester method
 - State 0: Rising edge of the signal at the center of the bit
 - State 1: Falling edge of the signal at the center of the bit
- 4) Intercharacter interval is 1 (TRUE) to allow synchronization of an external device.

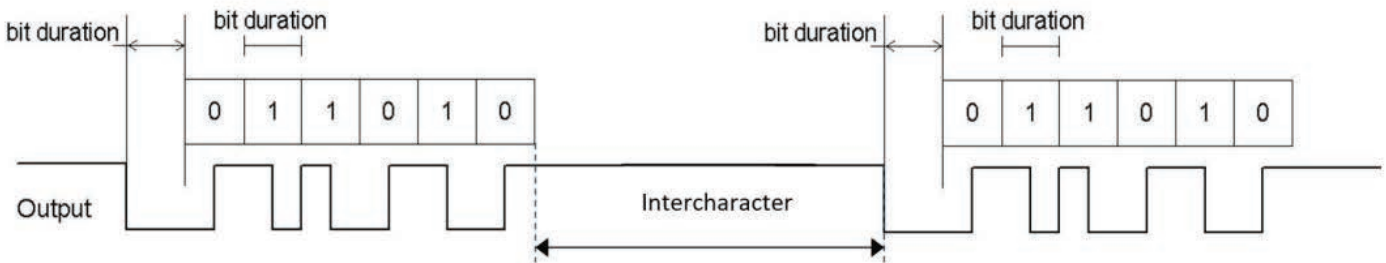

Therefore, with the Asynchronous method the Clock output is not present

Synchronous serialization:

- 1) The output and the clock in the idle condition are 0 (FALSE);
- 2) Transmission of n bits with the input status using OUTPUT as data, CLOCK as the timing base
- 3) Intercharacter interval is 0 (FALSE) to allow synchronization of an external device.

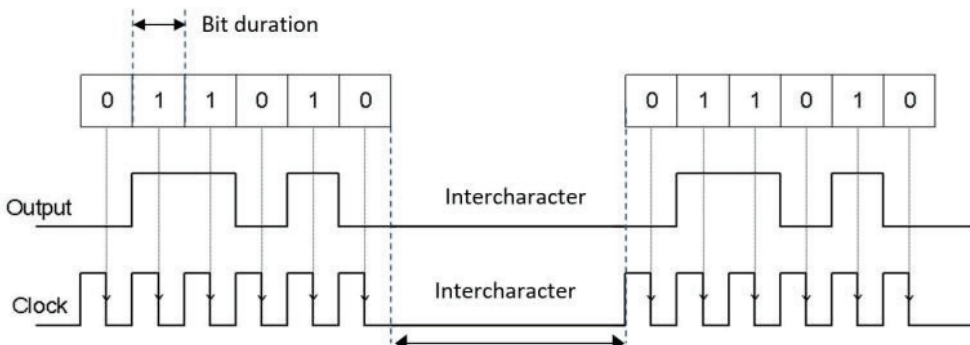

Parameters

Inputs number:

Defines the number of inputs of the function block, which may be 2÷8 (asynchronous) or 3÷8 (synchronous)

Bit duration (ms):

Enter the value corresponding to the length of each single bit (input n) in the pulse train that makes up the transmission.

- 40 ms ÷ 200 ms (Step 10 ms)
- 250 ms ÷ 0.95 s (Step 50 ms)

Intercharacter duration (ms):

Enter the time that must pass between the transmission of one pulse train and the next.

- 100 ms ÷ 2.5 s (Step 100 ms)
- 3 s ÷ 6 s (Step 500 ms)

NETWORK

The Network operator is used to distribute Stop and Reset commands via a simple local network. Use Network_in and Network_out to exchange START, STOP and RUN signals between the different nodes.

Operating principles:

This operator allows stop and reset commands to be distributed simply in a local PLC network.

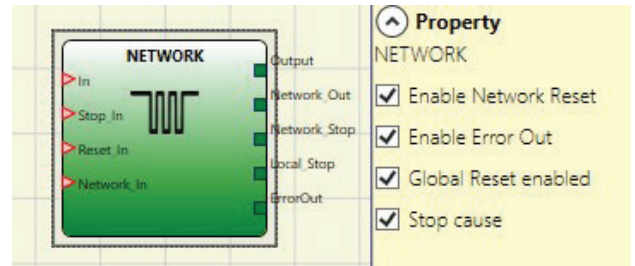

The Network operator requires the following:

1. Network_In input connected to a single or double input must be connected to the Network_Out output of the preceding unit in the local network.
2. Network_Out output connected to a STATUS signal or OSSD output must be connected to the Network_in input of the next unit in the local network.
3. Stop_In and Reset_In inputs must be connected to input devices that act as Stop (e.g. E-STOP) and Reset (e.g. SWITCH), respectively.
4. In input can be connected freely in the diagram (e.g. input function blocks or results of logical combinations).
5. Output can be connected freely in the diagram. Output is 1 (TRUE) when the IN input is 1 (TRUE) and the function block has been restarted.

Parameters

Enable Network Reset:

When selected this allows the distribution network to reset the function block. If not enabled, the function block can only be reset via the local Reset_In input.

Enable Error Out:

If selected this enables the presence of the Error_Out status signal.

Globale Reset enabled (only UG 6911.10 **NOT** UG 6911.12/080):

If selected, the operator can restart the entire system with the reset button from any node in the network. If deselected the operator can restart all the nodes **that have been not caused the stop** from anywhere in the network, except the node that has caused the stop (this node has to be restarted with its own reset).

Stop cause (only UG 6911.12/080):

If selected, it enables the **Network_stop** and **Local_stop** outputs and indicates the cause of the STOP status. These outputs are normally at 0 with the system in RUN and the Output at 1. If a network stop is requested, the Network_stop output increases to 1. If the Output output goes to 0 due to the In input or the Stop_in input, the Local_stop output goes to 1. The outputs will remain in this status until the next main reset.



The RESET commands must be installed outside all the danger areas of the network in positions where the danger areas and the entire work areas are clearly visible.



The maximum number of UG 6911.10 modules that can be connected in a network configuration is equal to 10.



Each UG 6911.10 module can have a maximum of 9 expansion modules connected.

Parameters

Condition 1:

With reference to the figures below, at power-on:

1. The Net_out of the various nodes are in the 0 (FALSE) condition;
2. The STOP signal is sent via the Net_out line;
3. When the RESET command is pressed on one of the nodes all the nodes that are present are started when the START signal is sent;
4. As the end result, the Net_out of all the connected nodes is in condition 1 (TRUE) if the various Net_in inputs are in condition 1 (TRUE);
5. The RUN signal is sent via the network of the 4 nodes present.

Condition 2:

With reference to the figures below, when the emergency stop is pressed in one of the four nodes:

1. The Net_out moves to condition 0 (FALSE);
2. The STOP signal is sent via the Net_out line;
3. The next node receives the stop code and deactivates the output;
4. The stop command generates the stop code for all Net_in and Net_out lines;
5. As the end result, the Net_out of all the connected nodes is in condition 0 (FALSE).
6. When the emergency stop is restored to the normal position, all the nodes can be restarted by sending the START signal with a single reset. The latter condition does not occur when ENABLE RESET NETWORK is not enabled. In that case, the local reset method must be used. The system will employ about 4s to restore all the outputs of the blocks that make up the network.

 Perform a local reset of the module which caused the network shutdown, to restore its safety output.

Response Time:

The max response time of the network starting from emergency stop is given by the formula:

UG 6911.10:	$tr = 11.3 \text{ ms} + [175.3 \text{ ms} \times (\text{Number of base modules} - 1)]$
UG 6911.12/080:	$tr = 12.7 \text{ ms} + [232.7 \text{ ms} \times (\text{Number of base modules} - 1)]$

	MASTER n°1	MASTER n°2	MASTER n°3	MASTER n°4
E-Stop pressing	$t_{r\text{MASTER1}}$	$t_{r\text{MASTER1}}$	$t_{r\text{MASTER1}}$	$t_{r\text{MASTER1}}$
	12,6ms	164ms	376ms	488ms

 The maximum number of networkable modules UG6911 is equal to 10.

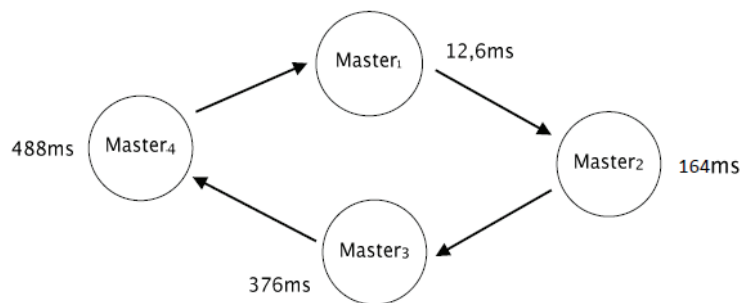

Parameters

Condition 3:

With reference to the figure below, when the IN input of the NETWORK function block of one of the 4 nodes moves to condition 0 (FALSE):

1. The local OUTPUT moves to condition 0 (FALSE);
2. The RUN signal continues to be sent via the Network_out lines;
3. The states of the remaining nodes remain unchanged;
4. In that case, local reset must be used. The Reset-in LED flashes to indicate this condition. This condition is signaled by the corresponding LED flashing Reset_In entrance. The affected node will be restarted with its own reset.

The Reset_in and Network_in inputs and the Network_out output can only be mapped to the I/O pins of the Master UG6911.10

LED signals on control unit UG 6911.10 with active network:

		NETWORK functional block signals					
		Network in		Network out (OSSD)	Network out (STATUS)	Reset in	
State		LED	FAIL EXT	IN ⁽¹⁾	OSSD ⁽²⁾	STATUS	IN ⁽³⁾
	STOP	OFF	OFF	OFF	RED	OFF	OFF
	CLEAR	OFF	OFF	flashing	RED/GREEN (flashing)	flashing	flashing
	RUN	OFF	OFF	ON	GREEN	ON	ON
	FAIL	ON	ON	blinkt	-	-	-

(1) LED corresponding to the input where is wired Network IN
 (2) LED corresponding to the output where is wired NETWORK OUT
 (3) LED corresponding to the input where is wired Reset IN

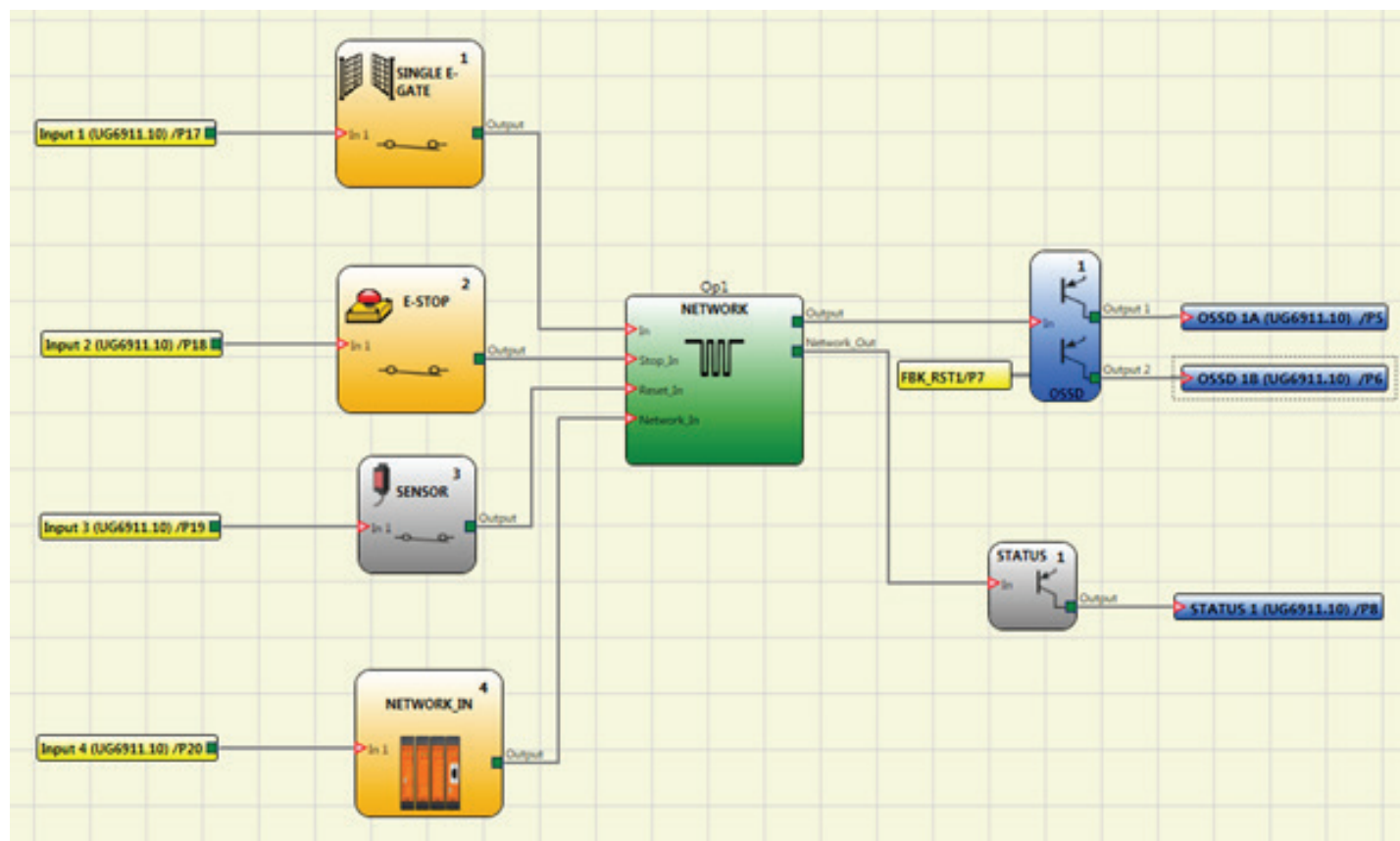

Example of use of the NETWORK block (Category 2)

Parameters

Example of application in Category 2 according to ISO 13849-1:

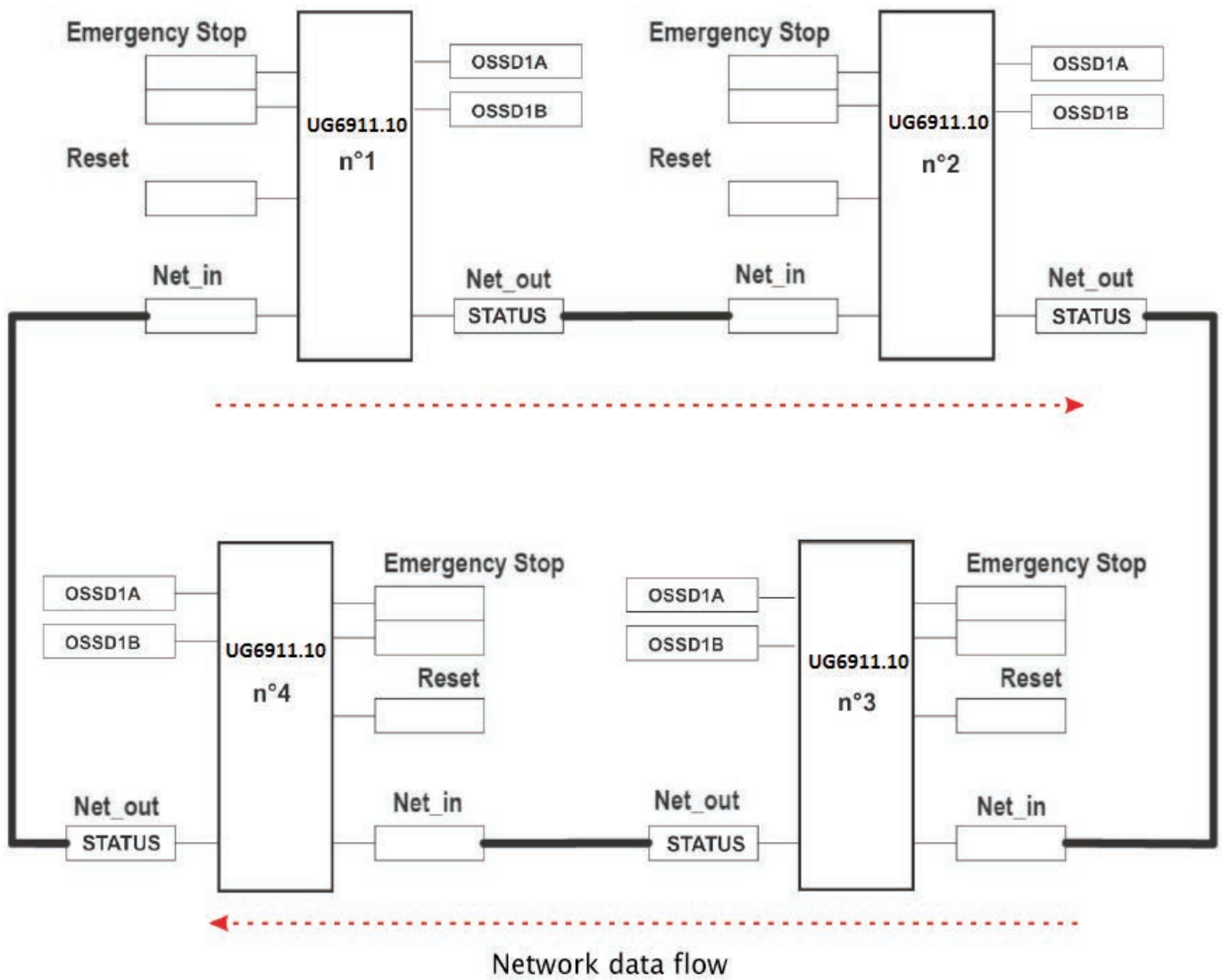

Network parameters for the PL calculation

Architecture:	Cat. 2
Diagnostic coverage:	DC = 90 %
Reliability of Module UG6911.10:	MTTF _d = 437 (years)

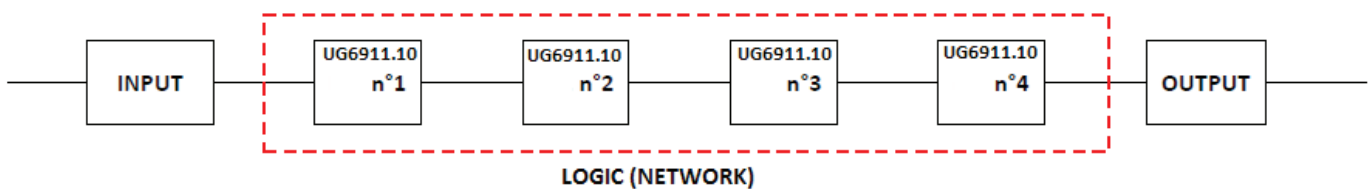

Parameters

Example of application in Category 4 according to ISO 13849-1:

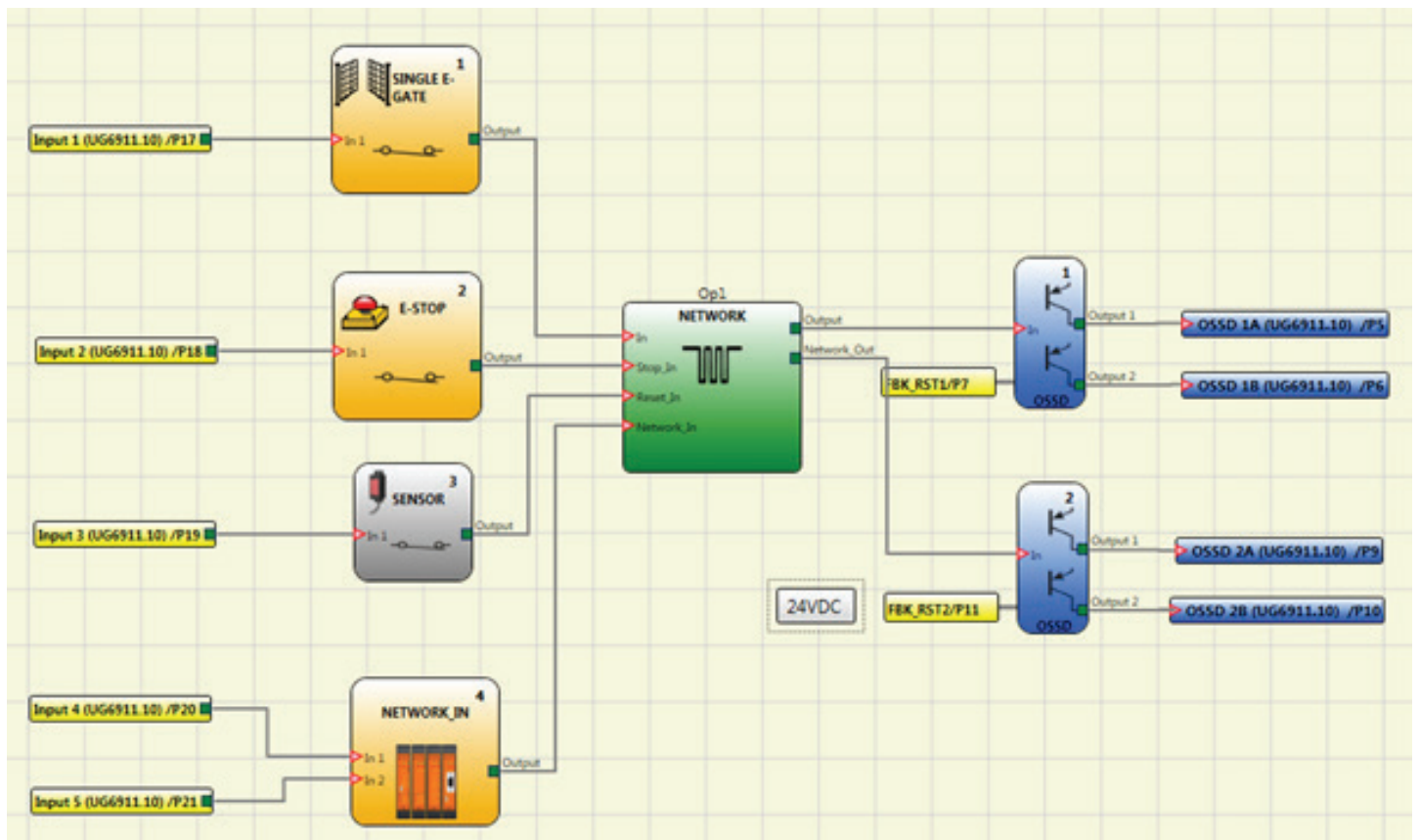

Example of use of the NETWORK block (Category 4)

Parameters

Example of application in Category 4 according to ISO 13849-1:

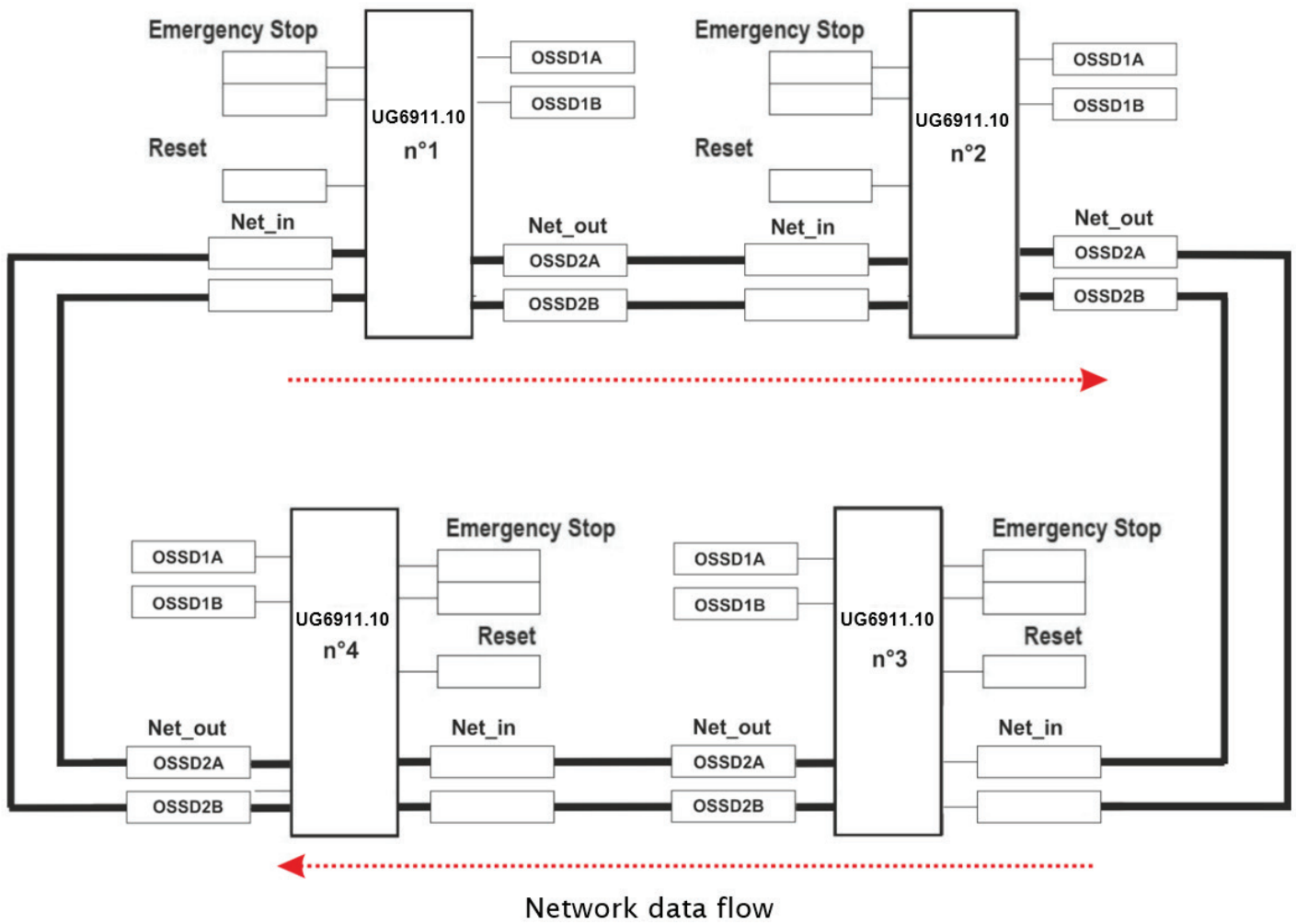

Network parameters for the PL calculation

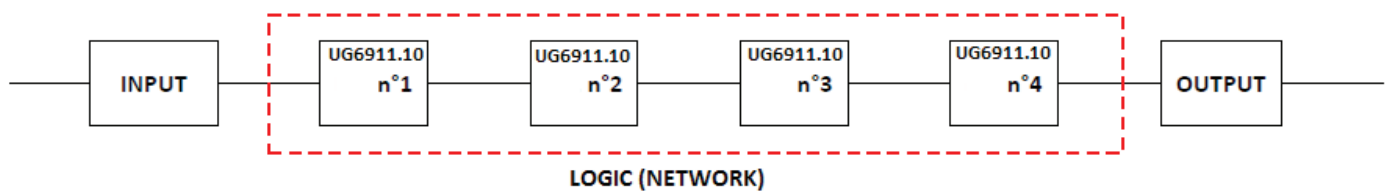

Architecture:	Cat. 4
Diagnostic coverage:	DC = 99%
PFH _d of module UG 6911.10	PFH _d = 6.86-09 (hours ⁻¹)

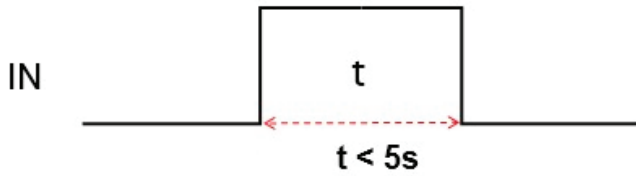

RESET

This operator generates a system Reset when there is a double OFF-ON-OFF transition on the corresponding input which lasts less than 5 s.



-  If $> 5s$, RESET is not generated.
-  It can be used to reset faults without disconnecting system power.

OSSD EDM (MAX. 32 WITH UG 6911.12/080)

The OSSD EDM (External Device Monitoring) operator allows to control an EDM feedback related to a safety output using a generic SAFEMASTER PRO input.

The Output can only be connected to one safety output functional block (OSSD, single OSSD, Relay). This output functional block must have the K external time monitor deactivated.

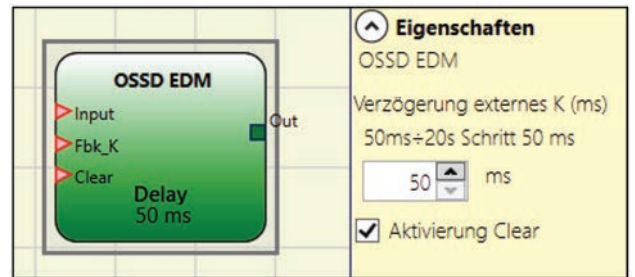

Output:

- OSSD output connected downstream is at high level (TRUE) \rightarrow the Fbk_K signal must be at low level (FALSE) (within the set delay) and vice versa.
- If the delay is not respected, the Output of the OSSD EDM block goes to low level (FALSE) and the anomaly is signaled by the flashing of the CLEAR led corresponding to the OSSD in error.

Enable Error Out:

If Enable Error Out of the connected output is selected, this output is set to high level (TRUE) when an external FBK error is detected (example: exceeded the external time K).

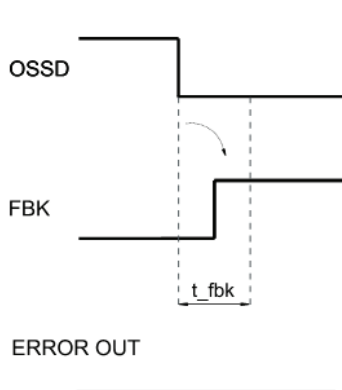

Example of OSSD with correct Fbk signal:
In this case ERROR OUT=FALSE

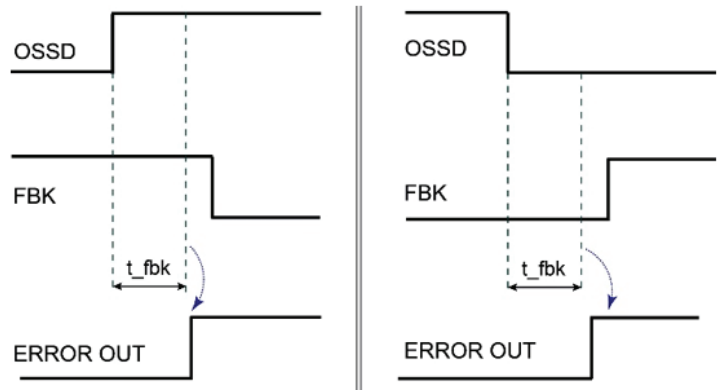

Example of OSSD with incorrect Fbk signal
(External K delay exceeded):
In this case ERROR OUT=TRUE

Parameters

External K delay:

Allows the operator to set the time window within which the external feedback signal (Fbk_K) is to be monitor according to output conditions.

Enable Clear:

With this input at 1 it is possible to clear the error when the fault has been repaired. Using this input it is no longer necessary to reset SAFEMASTER PRO UG 6911.12/080 or turn off the system.

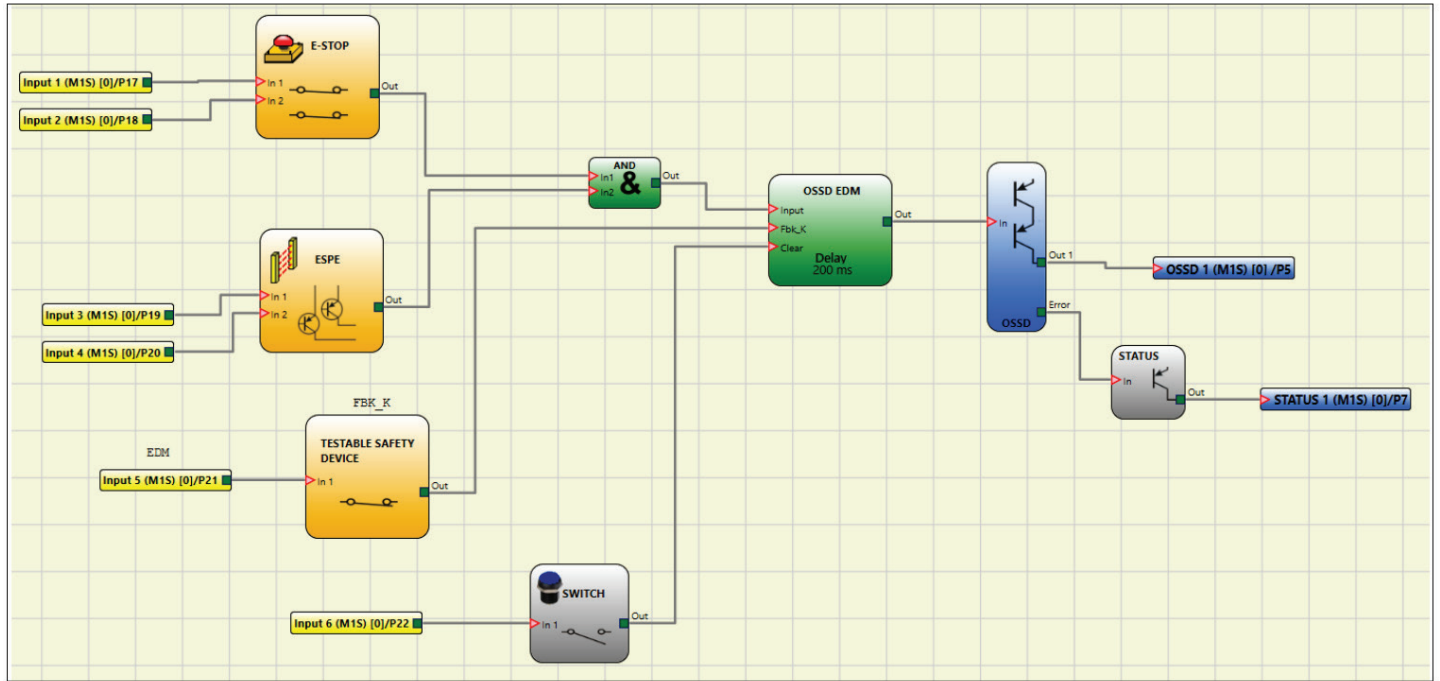

OSSD EDM operator scheme example

INTERPAGE IN / OUT

If the scheme is very complicated and requires a connection between two elements very far, use the "Interpage" component.

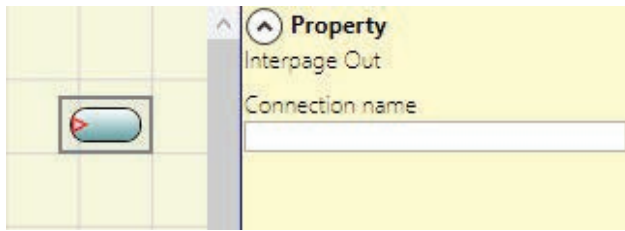

(left side of the schematic)

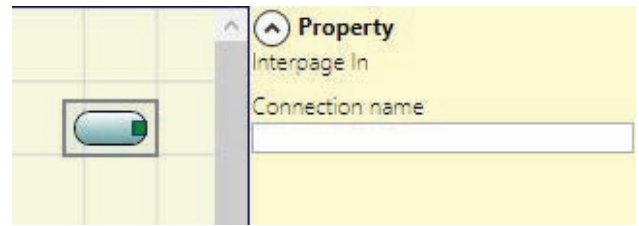

(right side of the schematic)

In order to set up a connection the elements "Interpage Out" and "Interpage In" must have the same name.

TERMINATOR

This operator can be connected to Input block OUTPUT only to allow this Input to be inserted without schematic connections.

The Input connected to Terminator appears in the Input map list and its state is transferred to the BUS.

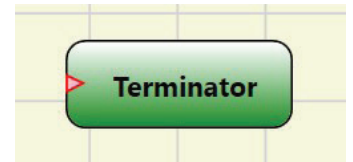

SPECIAL APPLICATIONS

OUTPUT DELAY WITH MANUAL RESET

If you need to have two OSSD output with one of them delayed (in MANUAL mode) use the following scheme

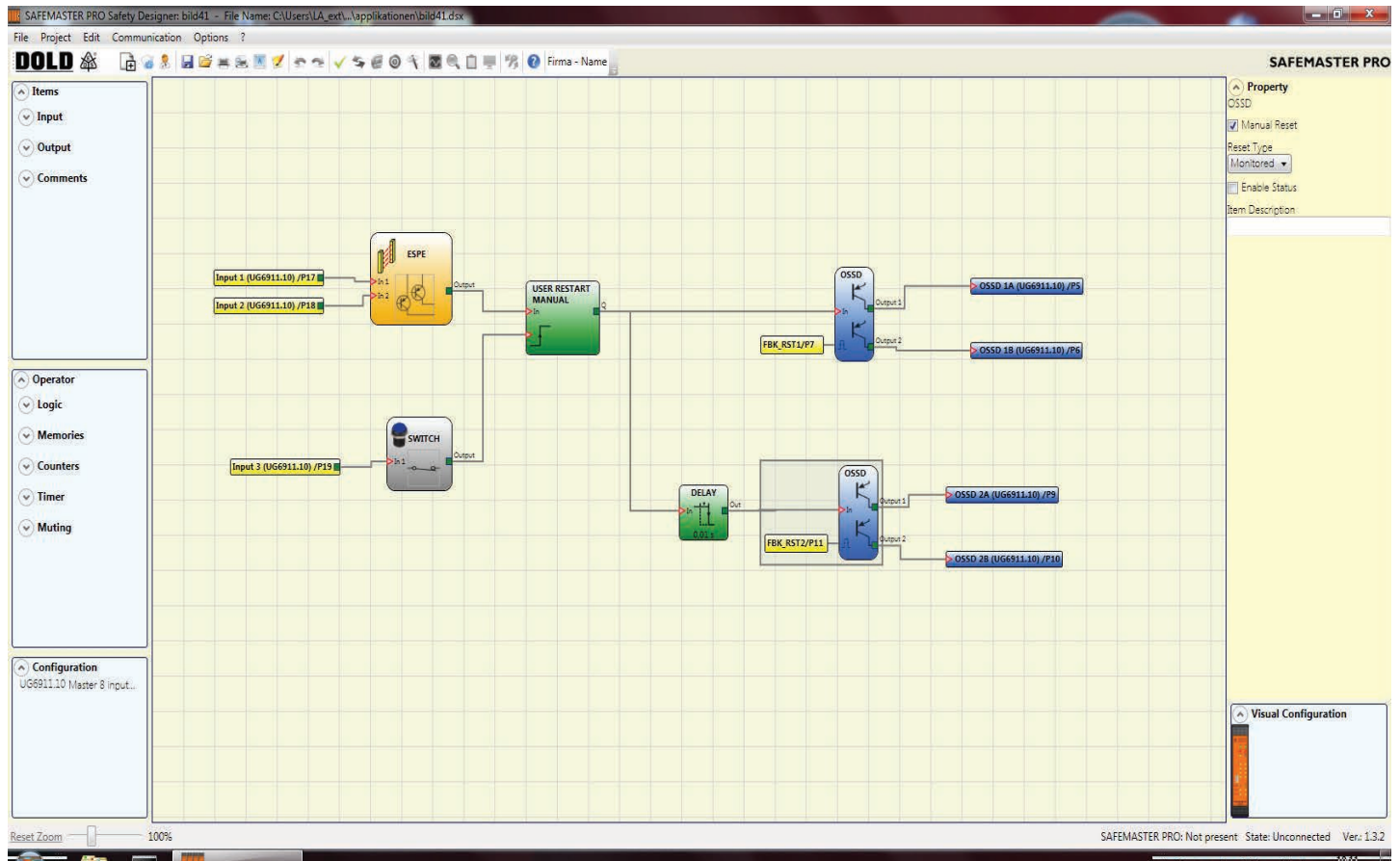





Two outputs with one delayed (in MANUAL mode)

Info Whereas the operating mode of the logical DELAY (see DELAY paragraph) the application must be the following:
 The two outputs have to be programmed with RESET TYPE manual (monitored) using the function USER MANUAL RESTART.

SIMULATOR

OUTPUT DELAY WITH MANUAL

-  This simulator is only designed to assist in the design of safety functions.
-  The results of the simulation do not constitute validation of the project.
-  The resulting safety function must always be validated, from the point of view of both hardware and software, under actual usage conditions in accordance with the applicable regulations, such as EN ISO 13849-2: validation or IEC 62061: Chapter 8 - Validation of the safety-related electrical control system..
-  SAFEMASTER PRO configuration safety parameters are provided in the SAFEMASTER PRO Designer software report.

 The simulation is only available with UG6911 firmware version 3.0 or higher.

The top toolbar features two new green icons. These icons refer to the new Simulator functions.

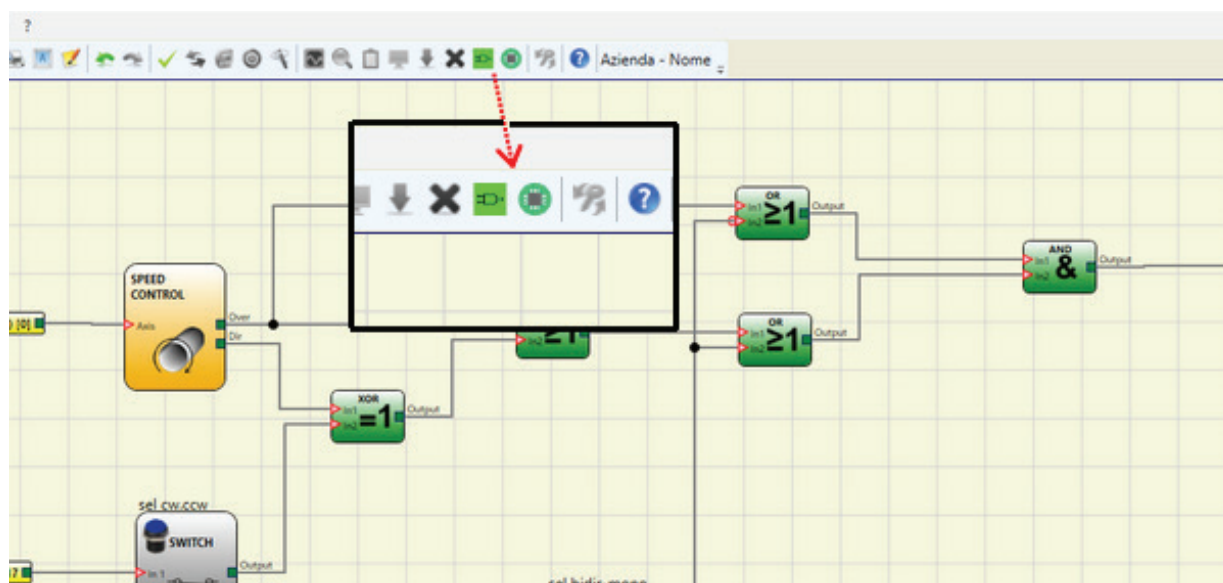

Simulation icons

The first icon  indicates “Schematic Simulation“. It enables the schematic simulator (both static and dynamic) in which you can activate the input to verify the diagram that is loaded.

The second icon  indicates “Graphic Simulation“. It enables the simulator guided by the stimuli file which also allows the desired traces to be displayed in a specific graph.

 The simulation icons are only available with node UG 6911.10 disconnected.

SCHEMATIC SIMULATION

Click on the icon  to start the schematic simulation.

Schematic simulation can be used to check/guide the output signals of the various function blocks in real-time, even during the actual simulation. You may choose the block outputs you wish to control and check the response of the various elements of the schematic model according to the colour of the different lines.

As with the monitor function, the colour of the line (or of the actual key) indicates the signal status: green means the signal is set to LL1, red means the signal is set to LL0.

With "Schematic Simulation", some new keys appear in the toolbar. These can be used to control the simulation: the "Play" and "Stop" keys to start and stop the simulation, the "PlayStep" key for step-by-step operation and the "Reset" key. When the simulation is reset, the Time value is reset to 0 ms.

When you press "Play" to start the simulation, the amount of time that has elapsed is displayed next to the word "Time". This time is measured in "Step" units of time multiplied by the user-defined "KT" factor.

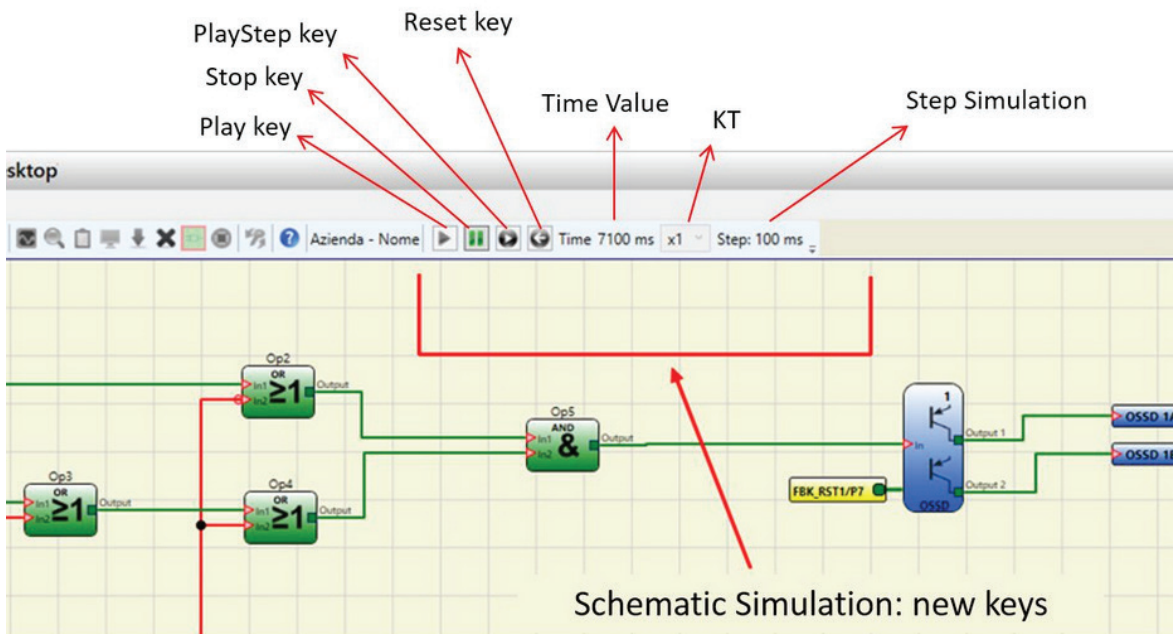

Schematic Simulation

Click on the bottom right key of each input block to activate the respective output status (even when the simulator is not running, i.e. when the time is not elapsing: in this case the simulation is "static"). If the key turns red when you click on it, the output will be set to level LL0. If it turns green, the output will be set to level LL1.

In some function blocks, such as "speed control" or "lock_feedback", for example, the key is grey. This indicates that the value must be entered manually in a specific pop-up window. The type of value to be entered differs according to the type of function block (e.g., in a "speed control" block you will need to enter the frequency).

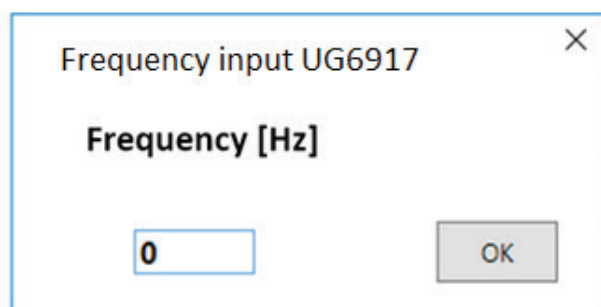
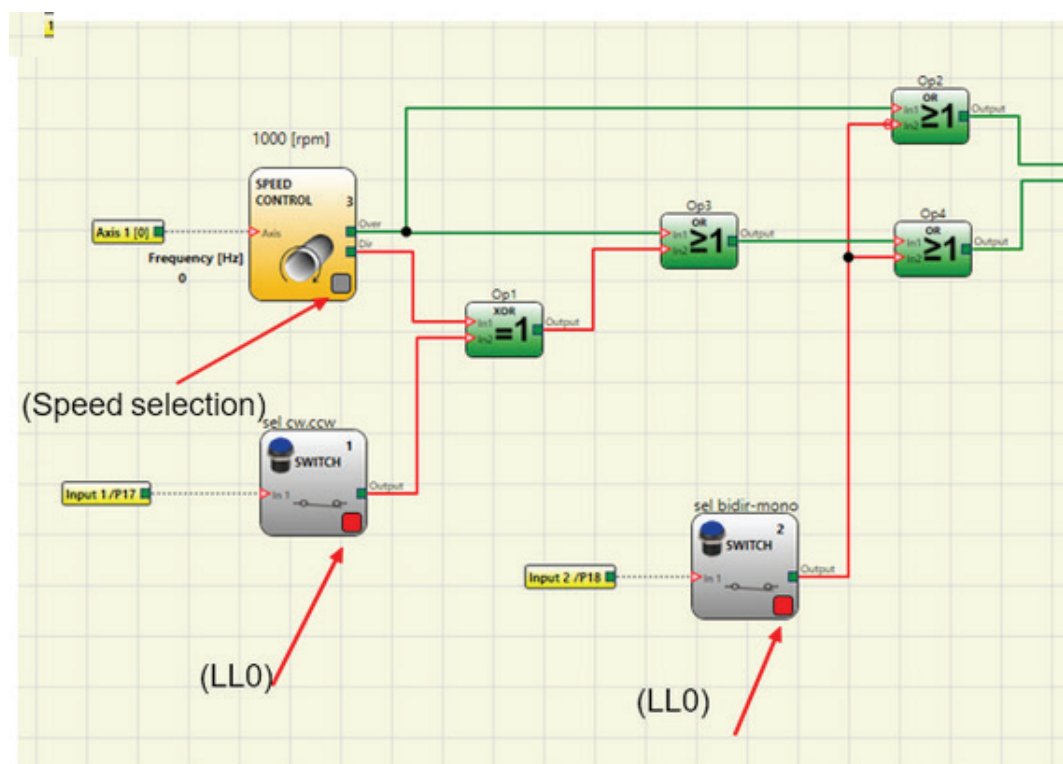

The upper diagram shows the activation of the output blocks;
The lower diagram shows a window for UG 6917 frequency input.

GRAPHIC SIMULATION

Click on the icon  to start the graphic simulation.

Graphic simulation can be used to display the signal pattern over time in a graph. First you must define the stimuli in a specific text file: this means defining the trend over time in the waveforms used as inputs (stimuli). Based on the stimuli file created, the simulator injects these into the diagram and displays the traces required in order to perform the simulation.

When the simulation is complete, a graph like the one shown below is automatically displayed. From the graph you can print the traces displayed ("Print"), save the results in order to load them again later (Save) or display other traces ("Change visibility"). The names of the traces match the description of the function blocks.

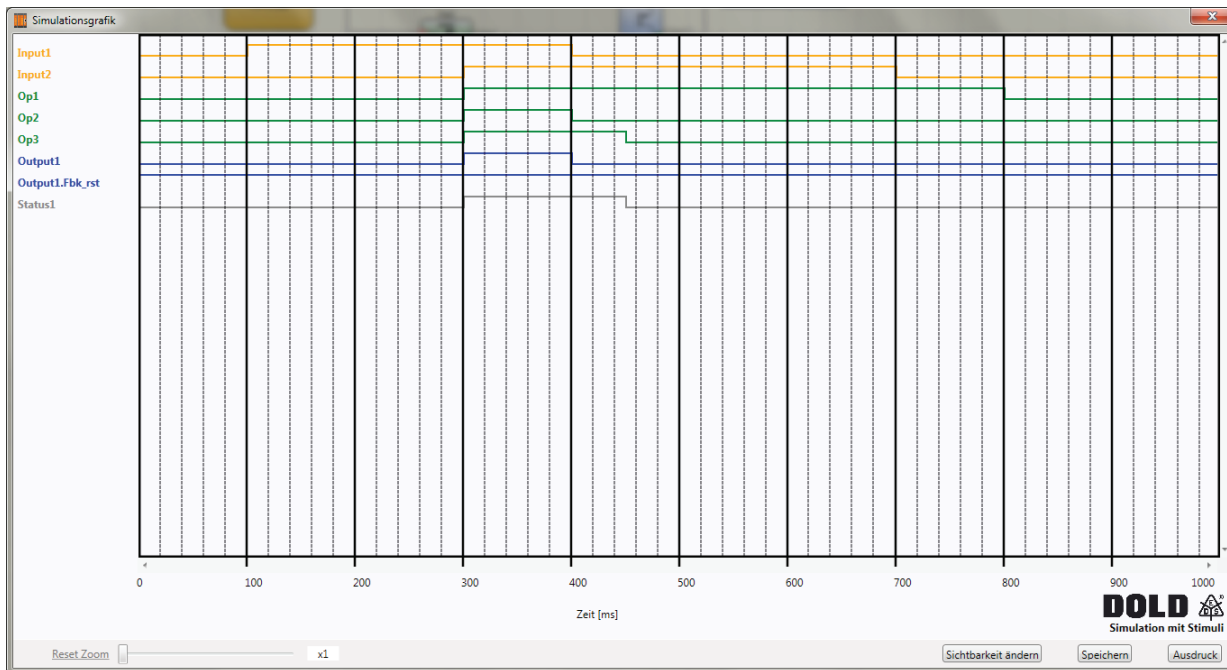

Example of a result of the graphic simulation

The simulation can only be carried out after performing at least the following steps:

1. Create a stimuli file to suit your needs
2. Upload the stimuli file and wait until the simulation finishes

Click on the icon  to display the page shown below:

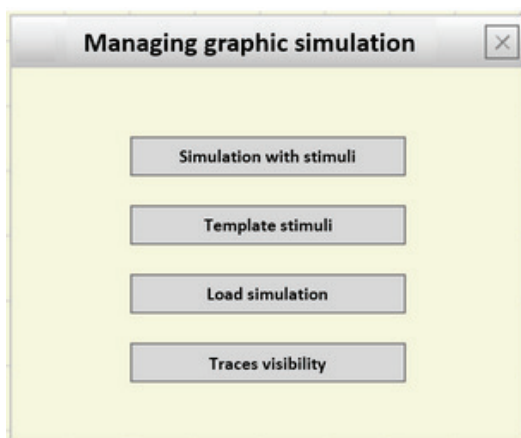

Menu for selecting the graphic simulation mode

Description of the menu items

Template Stimuli:

Used to save the template file with the desired name and disk location. This file will contain the names of the signals as shown in the diagram 69. Now you may use a text editor to enter the status of the input signals at a given moment in time as well as the duration of the simulation and the time step to be used.

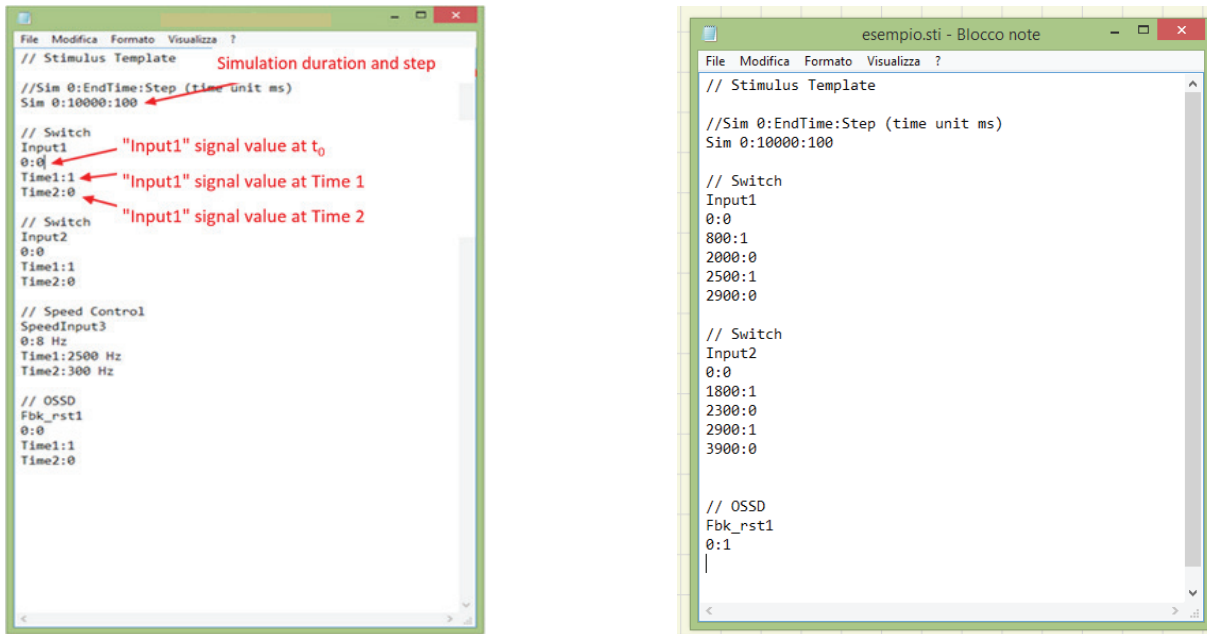

Example of complete template file

Simulation with Stimuli:

Used to load a template file (suitably completed) and, once loaded, to immediately start the simulation. At the end of the simulation, a graph is displayed with the resulting signals.

Load Simulation:

Used to load a previously completed simulation, provided at least one has been saved.

Traces Visibility:

Used to select the traces (signal waveforms) to be displayed in the graph. When you press this key, it opens a pop-up window as shown in Figure 53 from which you can add or remove traces to or from the graph.



Traces visibility



The traces that can be added to the graph are shown in the box on the left. The traces currently displayed and which can be removed from the graph are shown in the box on the right.

Description of the menu items

Application example of graphic simulation

The following example refers to the use of a press located inside a safety area. The motor of the press can only be started when two conditions are simultaneously true: the safety area gate is closed and the command to start the motor is sent. The motor will start two seconds after the start signal is sent.

Diagram

In the diagram the input elements are the safety area gate and the motor start command. These two signals are used as the input for an AND logic operator the result of which will be delayed by two seconds by a retarder block. The delayed signal will then energize the relay which will, in turn, allow the press motor to be started.

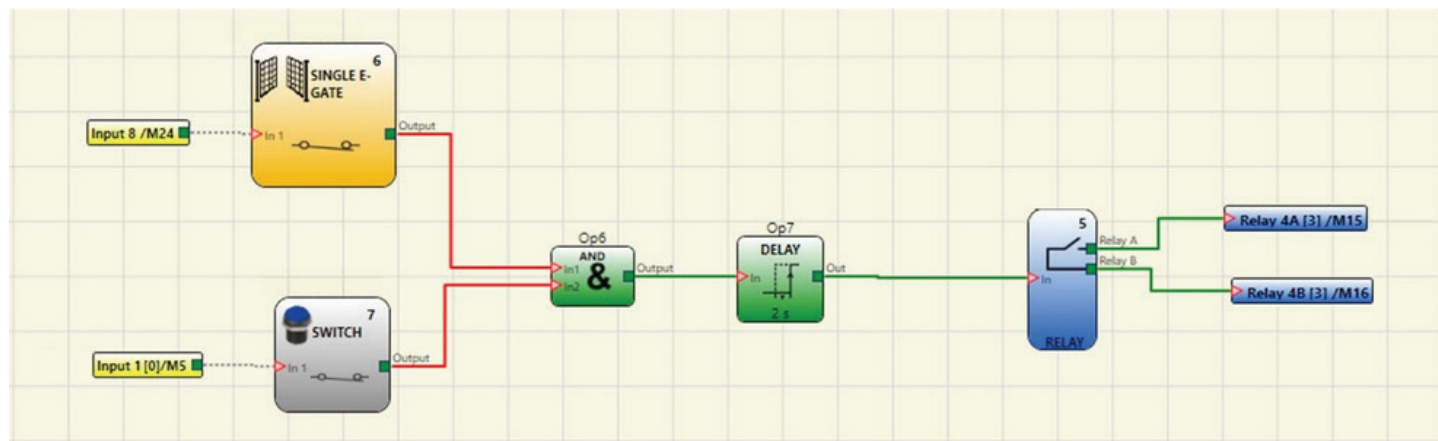

Diagram referring to the application example

Stimuli File

The stimuli file provide the closure of the gate when 2000 ms have elapsed (signal set to LL1) and the start command sent by the operator when 3000 ms have elapsed (signal set to LL1).

```

1 // Stimulus Template
2
3 //Sim 0:EndTime:Step (time unit ms)
4 Sim 0:10000:100
5
6 // Single E-Gate - Safe Area Gate
7 Input6
8 0:0
9 2000:1
10 10000:0
11
12 // Switch Press Start button
13 Input7
14 0:0
15 3000:1
16 10000:0
    
```

Stimuli file referring to the application example

Description of the menu items

Result of the simulation

The graph shows the signals relating to the simulation, in this case:

- When 2000 ms have elapsed the “Safety area” signal rises to logic level 1, which indicates closing of the gate.
- When 3000 ms have elapsed the “Start_Press” signal rises to logic level 1, which indicates the request to start sent by the operator.
- The AND operator output signal “OP6” rises to logic level 1 when 3000 ms have elapsed, i.e., when the two „Safety area“ and „Start_Press“ inputs rise to logic level 1.
- The AND operator output signal is delayed by 2000 ms by the delay operator.
- The “OP7” retarder output signal sends the command to close the relay when 5000 ms have elapsed, at which time the „M-press“ relay is activated.

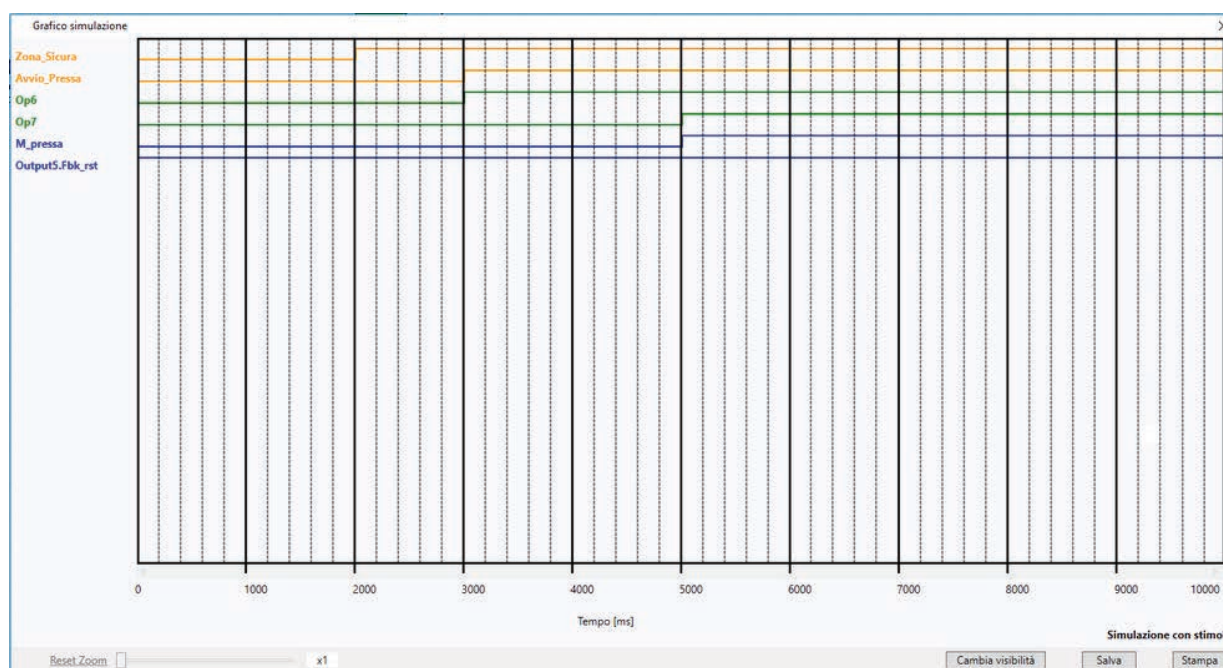

Graph produced by the simulation of the application example

ACCESSORIES AND SPARE PARTS

Type	Description	Art.-number
UG 6911.10	Control unit (8 Input / 2 dual channel OSSD), with software SAFEMASTER PRO DESIGNER	0063818
UG 6911.12/080	Control unit (8 Input / 4 single channel OSSD), with software SAFEMASTER PRO DESIGNER	0068574
UG 6916.10	Input/Output module (8 Input / 2 dual channel OSSD)	0063819
UG 6916.12/080	Input/Output module (8 Input / 4 single channel OSSD)	0068590
UG 6913.08	Input module (8 inputs)	0063820
UG 6913.12	Input module (12 inputs)	0064865
UG 6913.16	Input module (16 inputs)	0063821
UG 6912.02	Output module OSSD (2 dual channel OSSD)	0063822
UG 6912.04	Output module OSSD (4 dual channel OSSD)	0063823
UG 6912.04/100	Output module OSSD (4 high current safety outputs)	0068286
UG 6912.14	Output module relay (1 safety relay output)	0063824
UG 6912.28	Output module relay (2 safety relay output)	0063825
UG 6914.04/000	Output module relay (4 safety relay output)	0066057
UG 6914.04/008	Output module relay (4 safety relay output + 8 status outputs)	0065990
UG 6915/008	Output module signal (8 signal outputs)	0068282
UG 6915/016	Output module signal (16 signal outputs)	0068284
UG 6917/002	Speed monitoring module (for 2 proximity switches)	0066059
UG 6917/102	Speed monitoring module (for 2 proximity switches + 1 TTL encoder)	0066060
UG 6917/112	Speed monitoring module (for 2 proximity switches + 2 TTL encoder)	0066061
UG 6917/202	Speed monitoring module (for 2 proximity switches + 1 HTL encoder)	0066062
UG 6917/222	Speed monitoring module (for 2 proximity switches + 2 HTL encoder)	0066063
UG 6917/302	Speed monitoring module (for 2 proximity switches + 1 Sin/Cos encoder)	0066064
UG 6917/332	Speed monitoring module (for 2 proximity switches + 2 Sin/Cos encoder)	0065992
UG 6918	BusExtender	0064866
UG 6951	Fieldbus module CANopen	0063828
UG 6952	Fieldbus module PROFIBUS DP	0063826
UG 6954	Fieldbus module PROFINET	0064861
UG 6955	Fieldbus module Ethernet IP	0064862
UG 6956	Fieldbus module EtherCAT	0064863
UG 6957	Fieldbus module Universal Serial Bus (USB)	0064864
UG 6958	Fieldbus module MODBUS TCP/IP	0068268
UG 6959	Fieldbus module MODBUS RTU	0068270
OA 6911	Memory chip	0063829
OA 6920	USB-connection cable for PC	0064160
BU 6921	Mounting set IN-RAIL-Bus 250 mm for DIN 7.5 mm Rail	0064244
BU 6922	Mounting set IN-RAIL-Bus 250 mm for DIN 15 mm Rail	0064245
PN 6919	Software SAFEMASTER PRO DESIGNER	0064246

Please, visit the website www.dold.com for the list of the authorized representative of each Country

LIABILITY

Precise, complete compliance with all standards, instructions and warnings in this handbook is essential for the correct operation of the device. E. DOLD & Söhne KG therefore declines any responsibility for all and anything resulting from failure to comply with all or some of the aforesaid instructions.

DOLD takes no responsibility for the solutions created by customers concerning the circuits, the electrical diagrams and the chosen configuration Parameters for their application. The implemented circuits and electrical diagrams and the system configuration Parameters values, including those of SAFEMASTER PRO, are fully under the responsibility of the user..

Characteristics are subject to change without prior notice.

No part of this document may be reproduced unless **authorized by DOLD.**

DECLARATION OF CONFORMITY

EG - Konformitätserklärung

Declaration of Conformity

Déclaration de conformité européenne



Hersteller: E. Dold & Söhne GmbH & Co. KG
Manufacturer: / Fabricant:
Anschrift: Bregstraße 18
Address: / Adresse: 78120 Furtwangen
 Germany

Produktbezeichnung: konfigurierbares Sicherheitssystem **SAFEMASTER PRO** mit: gemäß Anhang
Product description: configurable safety system with: in accordance with annex
Désignation du produit: système de sécurité configurable avec: selon l'annexe

Das bezeichnete Produkt stimmt mit den Vorschriften folgender europäischer Richtlinien überein:
 The indicated product is in conformance with the regulations of the following european directives:
 Le produit désigné est conforme aux instructions des directives européennes:

Maschinenrichtlinie: <i>Machinery directive: / Directives Machines:</i>	2006/42/EG	EU-Abl. L157/24, 09.06.2006
EMV - Richtlinie: <i>EMC - Directive: / Directives- CEM::</i>	2014/30/EU	EU-Abl. L96/79, 29.03.2014
RoHS - Richtlinie <i>RoHS -Directive: / Directives - RoHS:</i>	2011/65/EU	EU-Abl. L174/88, 01.07.2011

Prüfgrundsätze: <i>Basis of Testing:</i>	EN ISO 13849-1:2015	EN IEC 61496-1:2020
<i>Lignes de contrôle:</i>	IEC 62061:2021	EN 81-20:2020
	EN 81-50:2020	EN 61508 Parts 1,3 :2010
	EN 61131-2	

Die Übereinstimmung eines Baumusters des bezeichneten Produktes mit der oben genannten Maschinenrichtlinie wurde bescheinigt durch:
 Consistency of a production sample with the marked product in accordance to the above machinery directive has been certified by:
 La conformité d'un échantillon du produit désigné aux directives machines susmentionnées a été certifiée par:

Benannte Stelle: TÜV Süd Product Service GmbH
Certification office: / l'organisme notifié: Ridlerstraße 65, 80339 München
Nummer der benannten Stelle: 0123
Number of certification office: / Numéro de l'organisme notifié:
Nummer der Bescheinigung: Z10 040066 0019 Rev. 01
Certification number: / Numéro de certificat:
Ausstellungsdatum : 16.03.2022
Date of issue: / Date de délivrance:

Für die Zusammenstellung der technischen Unterlagen ist bevollmächtigt:
For the compilation of technical documents is authorized:
Pour la composition des documents techniques est autorisé:

Rechtsverbindliche Unterschrift:
Signature of authorized person:
Signature autorisée :

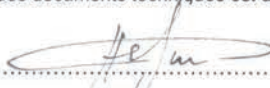
 Gamal Hagar, Entwicklungsleiter / R&D Manager

 Christian Dold, Produktmanagement / Productmanagement

Ort, Datum : Furtwangen, 17.03.2022
Place, Date: / Lieu, date:

Diese Original - Erklärung bescheinigt die Übereinstimmung mit den genannten Richtlinien, beinhaltet jedoch keine Zusicherung von Eigenschaften. Die Sicherheitshinweise der Produktdokumentation sind zu beachten.
 This original declaration confirms the conformity of the mentioned directives but does not comprise any guarantee of the product characteristics. The safety directives of the product documentation are to be considered.
 Cette déclaration originale certifie la conformité des directives nommées mais ne comprend aucune garantie des caractéristiques du produit. Les directives de sécurité de la documentation du produit sont à considérer.

DECLARATION OF CONFORMITY

EG - Konformitätserklärung

Declaration of Conformity

Déclaration de conformité européenne



Anhang zur EG-Konformitätserklärung Safemaster PRO - 17.03.2022 :

Annex to the declaration of conformity Safemaster PRO - 17.03.2022 :

l'annexe à la déclaration de conformité SAFEMASTER PRO - 17.03.2022 :

mögliche Produkte des Systems :

possible products of system :

produits possibles du système :

UG6911.10 UG6911.12/080	Steuereinheit Control unit Unité de contrôle		
UG6912.kk UG6912.04/vvv	Ausgangsmodul Output module Module de sortie	mit : with : avec :	kk = 02, 04, 14, 28 vvv = 100
UG6913.kk	Eingangsmodul Input module Module d'entrée	mit : with : avec :	kk = 08, 12, 16
UG6914.kk/vvv	Ausgangsmodul Relais Output module relay Module de sortie relais	mit : with : avec :	kk = 04 vvv = 000, 008
UG6915/vvv	Ausgangsmodul Signal Output module signal Module de sortie signalisation	mit : with : avec :	vvv = 008, 016
UG6916.10 UG6916.12/080	Ein- / Ausgangsmodul Input / Output module Module d'entrée / - sortie		
UG6917/vvv	Drehzahlüberwachungsmodul Speed monitoring module Module de contrôle de vitesse de rotation	mit : with : avec :	vvv = 002, 102, 112, 202, 222, 302, 332
UG6918	Bus Extender Bus extender Module d'extension bus		
UG6951	Feldbusmodul CANopen Fieldbus module CANopen Module bus de terrain CANopen		
UG6952	Feldbusmodul Profibus DP-V1 Fieldbus module Profibus DP-V1 Module bus de terrain Profibus DP-V1		
UG6953	Feldbusmodul DeviceNet Fieldbus module DeviceNet Module bus de terrain DeviceNet		
UG6954	Feldbusmodul PROFINET Fieldbus module PROFINET Module bus de terrain PROFINET		
UG6955	Feldbusmodul Ethernet-IP Fieldbus module Ethernet-IP Module bus de terrain Ethernet-IP		
UG6956	Feldbusmodul EtherCAT Fieldbus module EtherCAT Module bus de terrain EtherCAT		
UG6957	Feldbusmodul USB Fieldbus module USB Module bus de terrain USB		
UG6958	Feldbusmodul Modbus TCP/IP Fieldbus module Modbus TCP/IP Module bus de terrain Modbus TCP/IP		
UG6959	Feldbusmodul Modbus RTU Fieldbus module Modbus RTU Module bus de terrain Modbus RTU		



DOLD



E. Dold & Söhne GmbH & Co. KG
Bregstraße 18 • 78120 Furtwangen • Germany
Phone: +49 7723 654-0 • Fax +49 7723 654356
dold-relays@dold.com • www.dold.com