

DYNAMISCHE SORPTIONSUNTERSUCHUNGEN AM SYSTEM VOC/AKTIVKOHLE

J. Möllmer



Institut für Nichtklassische Chemie Leipzig e.V.

Outline

- Effects influencing breakthrough curve measurements
 - Dosage of organics
 - Requirements
 - Limitations
- Example I (VOC separation from biomass plant)
- Example II (VOC/humidity on AC)

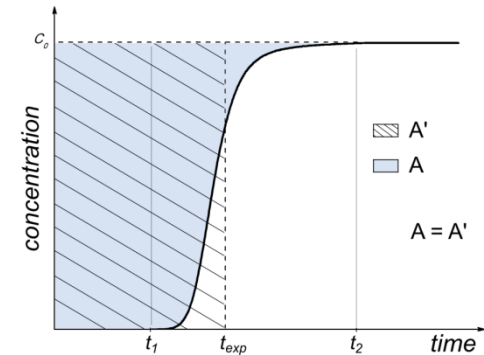

VOC – Volatile Organic Compounds

Vaporizable, carbon-containing compounds



Motor vehicles

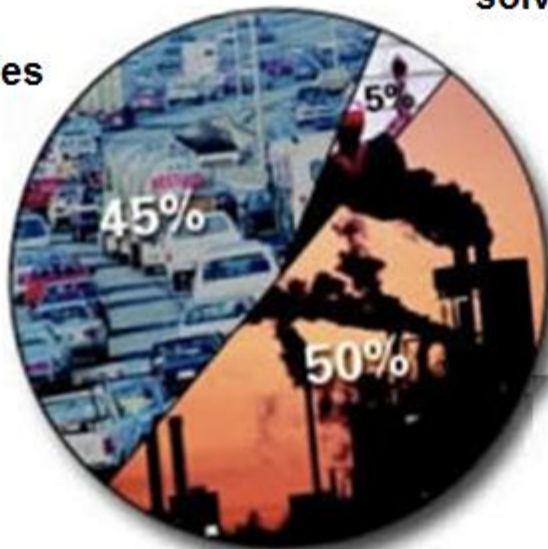

Consumer solvents



Industrial/
Commercial
Processes



SOURCES OF VOC

Contamination leads to massive health issues like

Cancer, Liver and kidney damage

Central nervous system damage

Overview – examples for VOC separation

Sorption with activated carbon

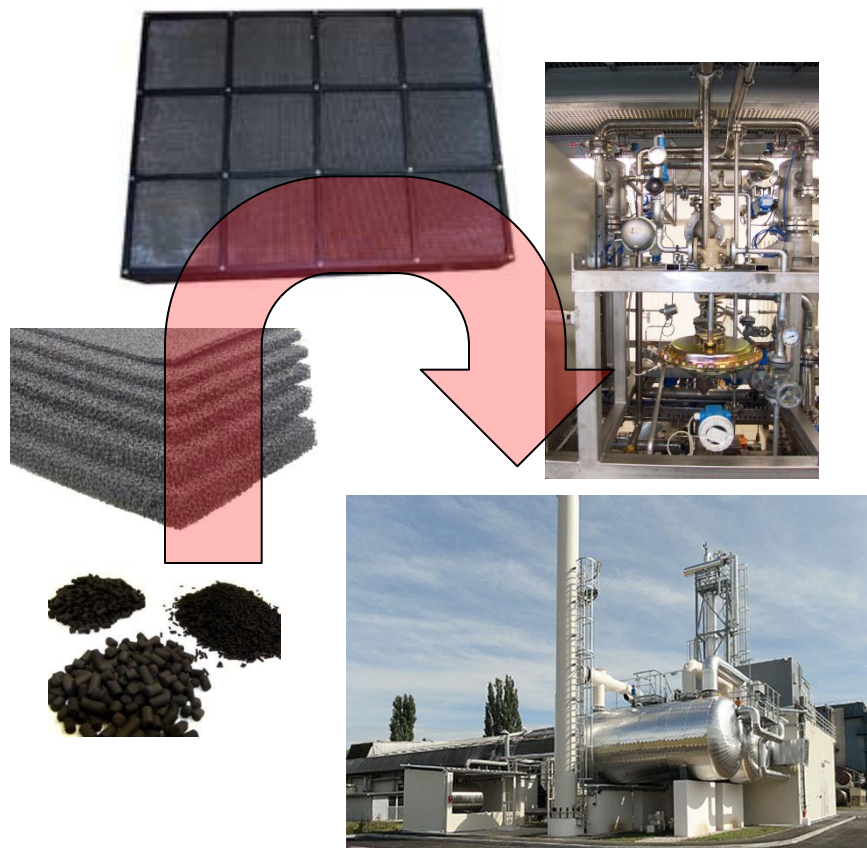

→ Breakthrough Testing

Thermal or catalytic decomposition

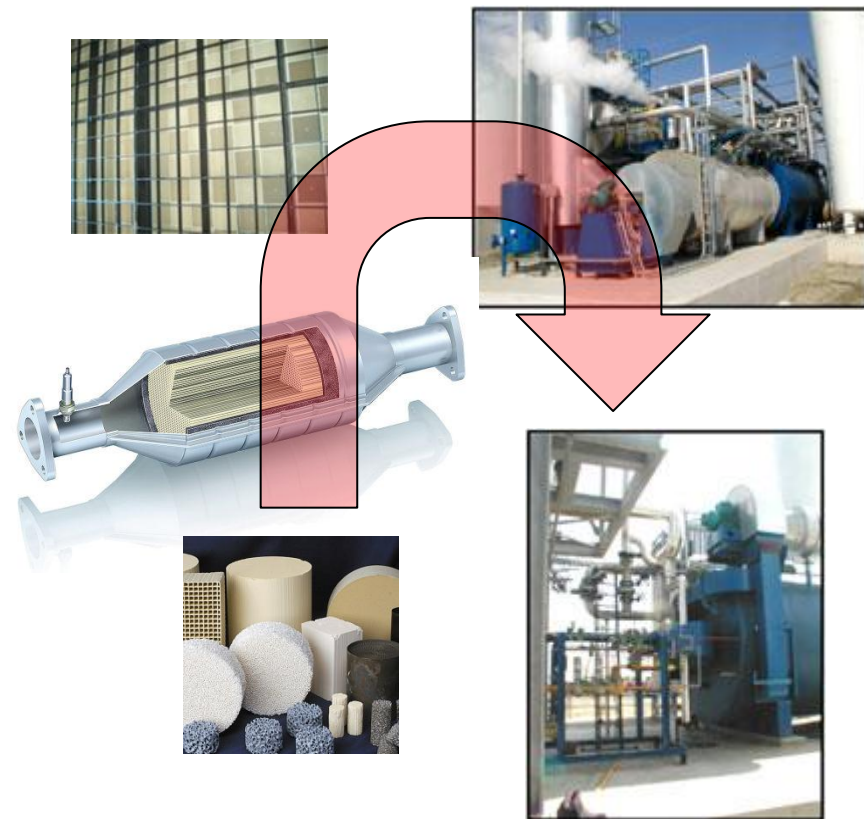

Overview – Principle of Breakthrough Measurement



Dosage system

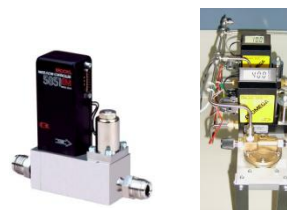

Mass flow controller



bubbler



Thermostated unit



Reactor/Adsorber



Glass or metal
version



Detector

FID, MS, IR, electrochemical,
others



Off-gas treatment (optional)

Dosage system – Example I

Providing a saturated inert gas flow by

- Bubbling with inert gas through one bubbler

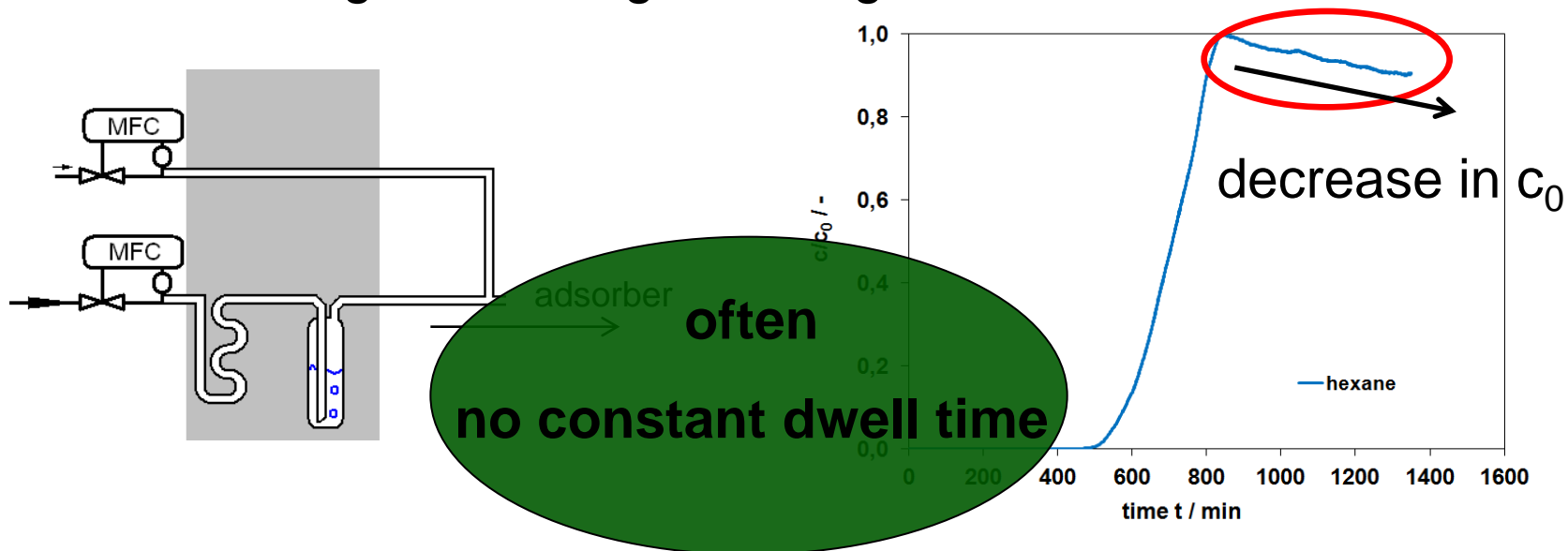

Pro

- No heater needed
- Easy handling

Contra

- Only for pure organics
- c_0 depends on fill level

Dosage system – Example II

Providing a saturated inert gas flow by

- Bubbling with inert gas through two bubbler

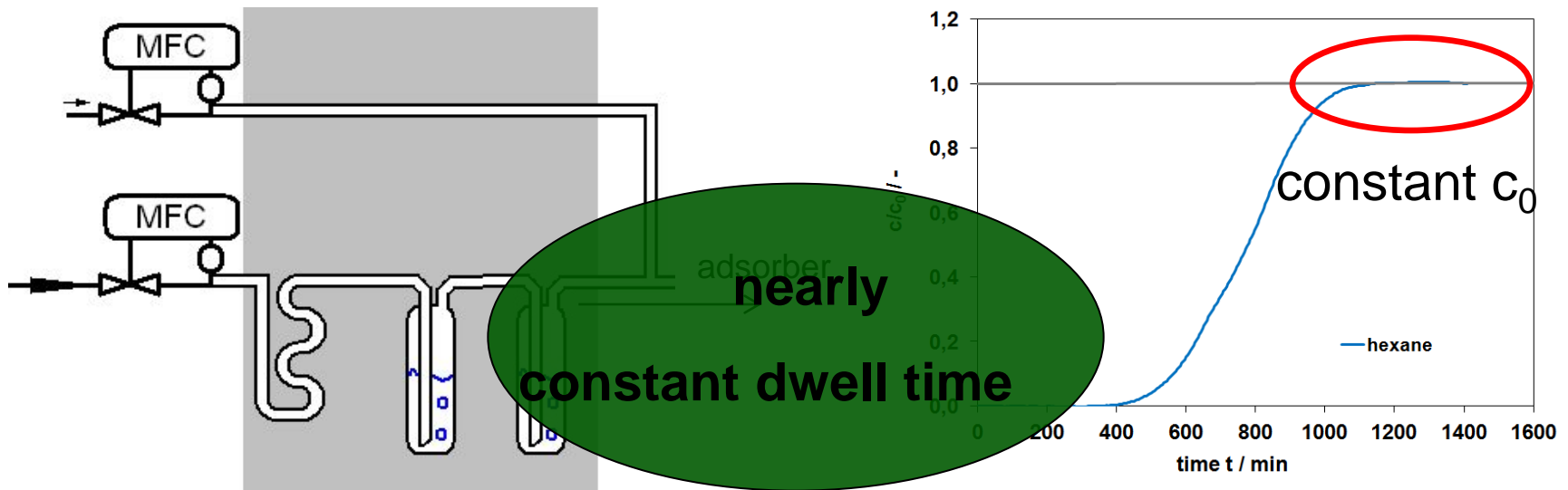

Pro

- No heater needed
- Nearly constant c_0

Contra

- Only for pure organics
- More complex handling

Dosage system – Example III

Providing a saturated inert gas flow by

- Heater/vaporizer – direct injection

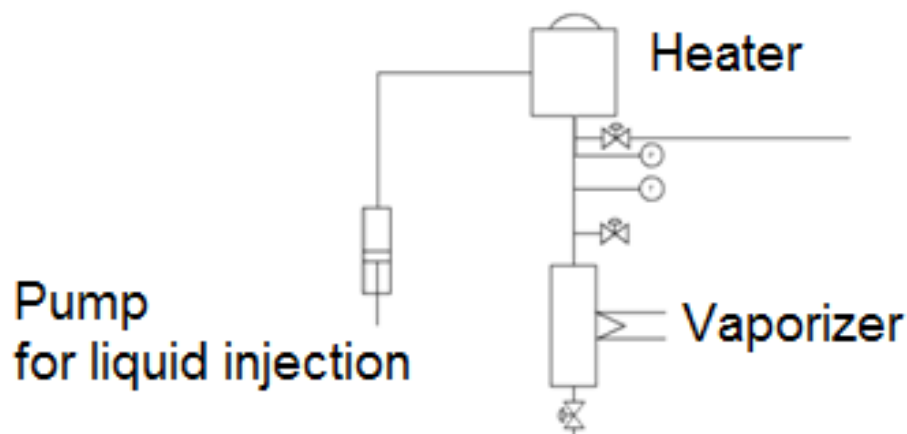

Pro

- Miscible liquid mixtures possible
- Direct control of c_0

Contra

- Heater is needed
- Complex equipment

Dosage system – limitations

- Larger concentration is limited due to the c_{sat} of the used solvent/VOC (depends on T and p)
 - be sure that no condensation can occur **(heating up tubes)**
- Low concentration is limited due to the c_{sat} of the used solvent/VOC (dilution; lower T possible)
 - normally dilution down to 1:500 works (dilution depends also on overall flow)
- Dilution below 1:500 – **use premixed testing gases !!!**

Reactor/Adsorber

Reactor differs in size and geometry

$$\rightarrow d_{\text{bed}} : d_{\text{Particle}} > 10:1$$

$$\rightarrow h_{\text{bed}} : d_{\text{bed}} > 3:1$$

$d_{\text{bed}} = 40 \text{ mm}$

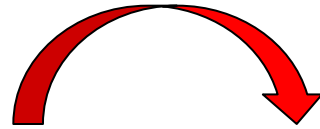
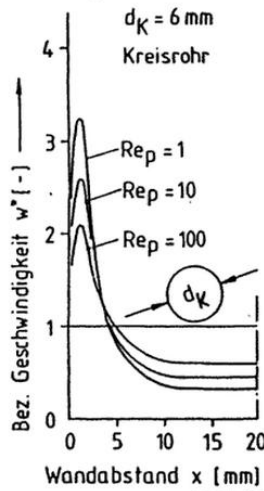

Minimization of
Bypass flow

Early breakthrough on wall

→ curve flattens

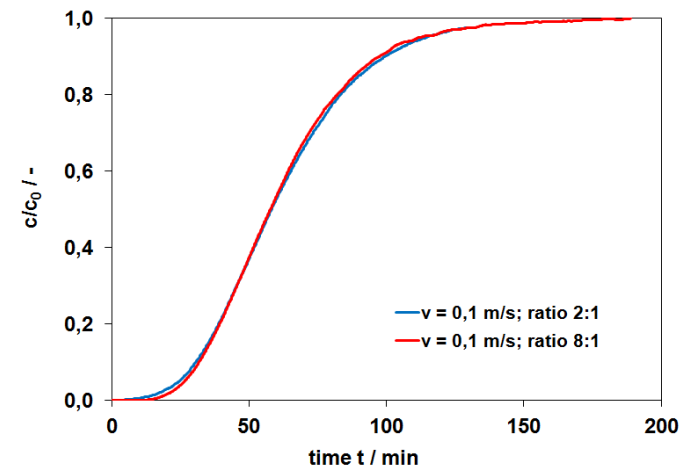

To do:

- Check bed parameters depending on particle size
- Check bed length and velocity for pressure drop

H.W. Kajsziika, Adsorptive Abluftreinigung und Lösemittelrückgewinnung durch Inertgasregenerierung, Utz Verlag, 1998.

Reactor/Adsorber

Reactor differs in size and geometry

$$\rightarrow d_{\text{bed}} : d_{\text{Particle}} > 10:1$$

$$\rightarrow h_{\text{bed}} : d_{\text{bed}} > 3:1$$

$d_{\text{bed}} = 40 \text{ mm}$

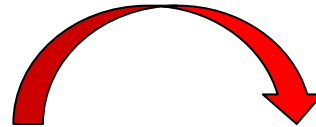
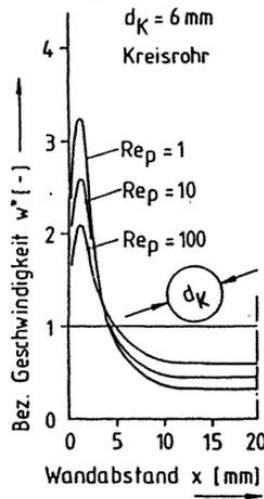

Minimization of
Bypass flow

Early breakthrough on wall

→ curve flattens

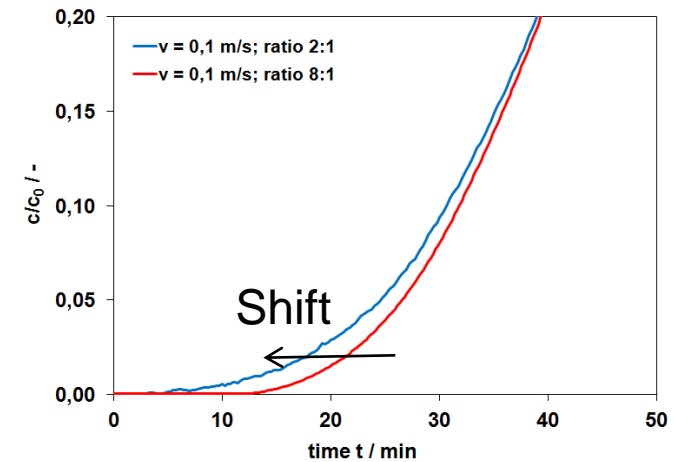

To do:

- Check bed parameters depending on particle size
- Check bed length and velocity for pressure drop

H.W. Kajsziika, Adsorptive Abluftreinigung und Lösemittelrückgewinnung durch Inertgasregenerierung, Utz Verlag, 1998.

Detector

Depends on analytical question

- Number of compounds
- Concentration range (**detection limit depends on scope**, but should be at least 100-1000 times lower as c_0)
- Check **time resolution** for online GC systems or ECD
- Coupled systems possible → be sure if the **overall flow is large enough for all analytical devices** (e.g. aspirated IR or μ GC)

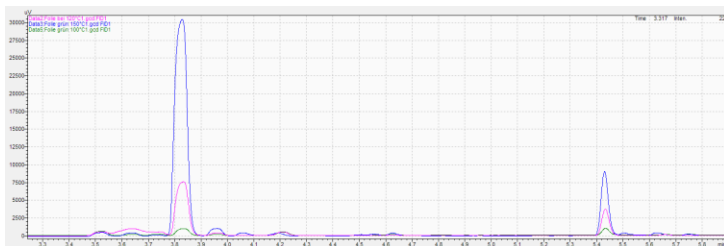

Dead time correction

- Dead time or volume – time is needed for flowing the bed up to the detection unit

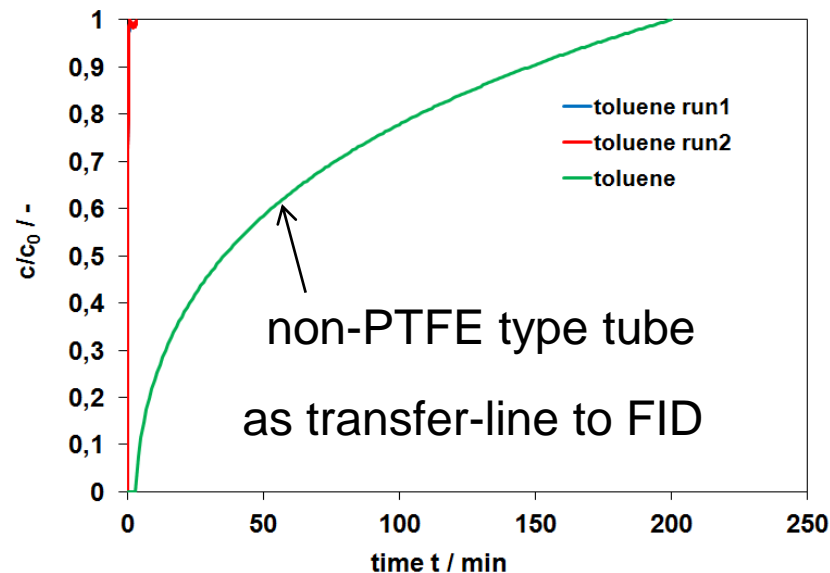
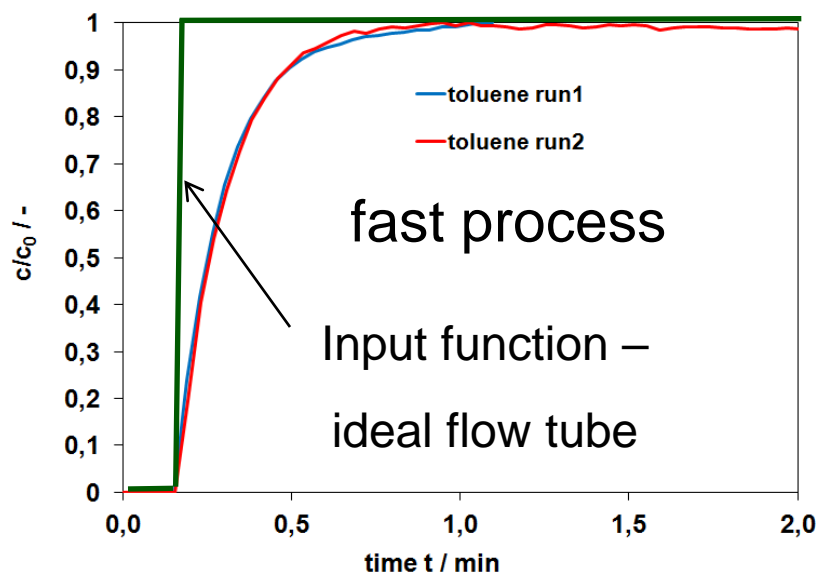

- Avoid interaction between VOC and tubes/fitting/sealing
- Avoid back mixing in the whole system

Summary I

- Breakthrough measurements can be a complex scenario
- Modular concept ensure high flexibility
- Check process conditions and select equipment, but

Down-scaling your process, be careful

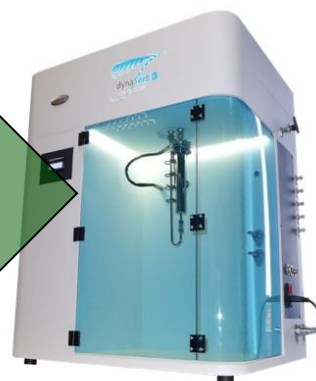

Example I - Biomass gasification

- Gasification of lignocellulosic biomass, mostly:



wood chips



cereal or maize straw

- Biomass → Gasification → Purification → Turbine/
Power plant

- Gasification agents: Air, O₂, Steam, (CO₂)

- Product gas contains: H₂ 35-45%, CO₂ 20-25%,
CO 19-25%, CH₄ 9-11%, C_xH_{2x+y} 3-4%, impurities
like benzene, toluene, styrene, ...

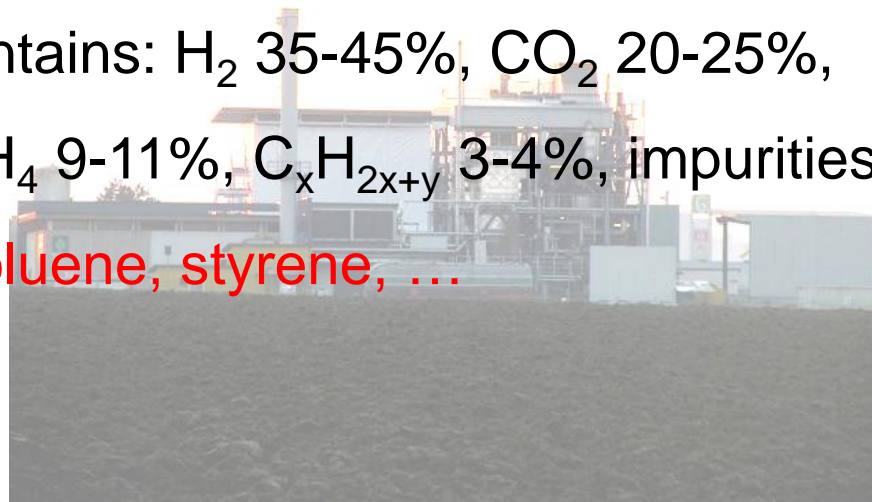

Adsorptive Purification – Lab test

Characterization of activated carbon

Isotherms



Static method

Hexane
Cyclohexane
Benzene
Toluene

Breakthrough experiments

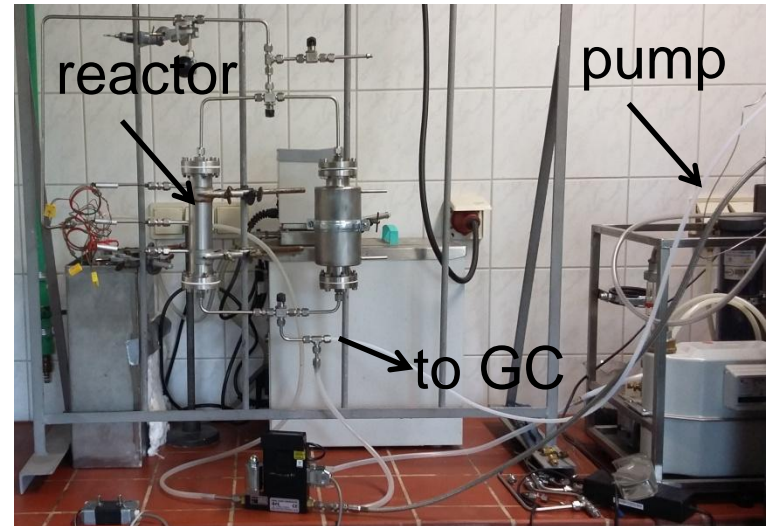

Dynamic experiment (fixed bed)

Experimental section: Breakthrough Curves

DynaSorb BT:

- Dynamic method
- Fully automated
- Different adsorber sizes available
- Temperature measurement inside the adsorber bed
- Data collecting and data evaluation tools (with simulation according LDF-approach)



DynaSorb BT

Adsorptive Purification – Lab test: isotherms

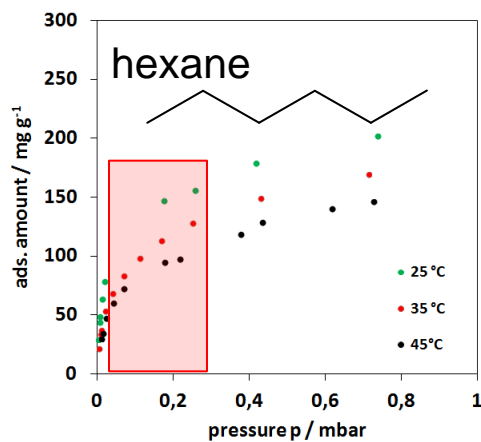
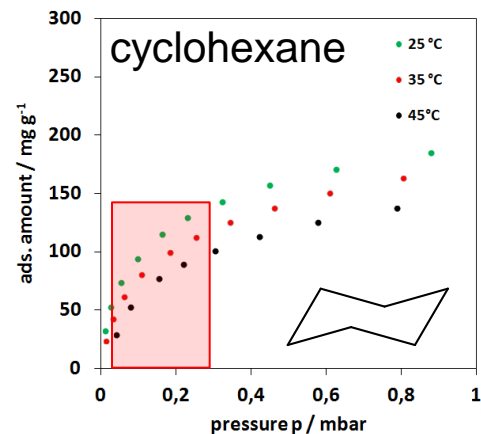
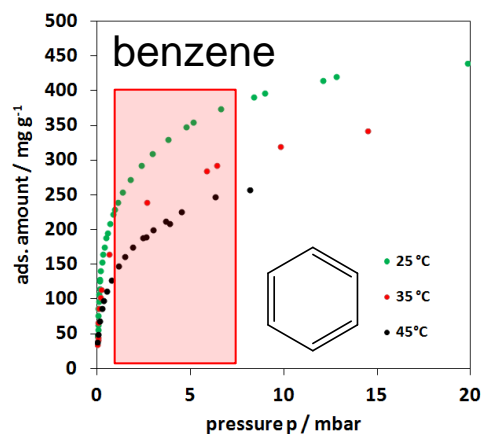
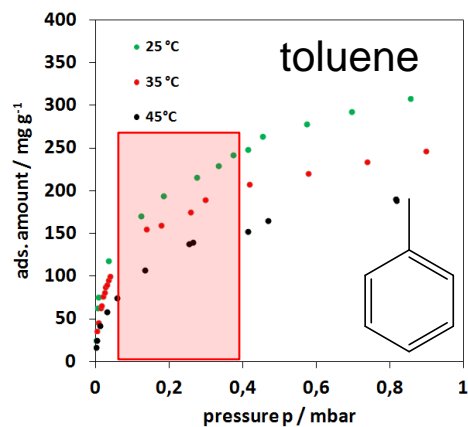

- Affinity: toluene > benzene > cyclohexane > hexane

 relevant concentration range

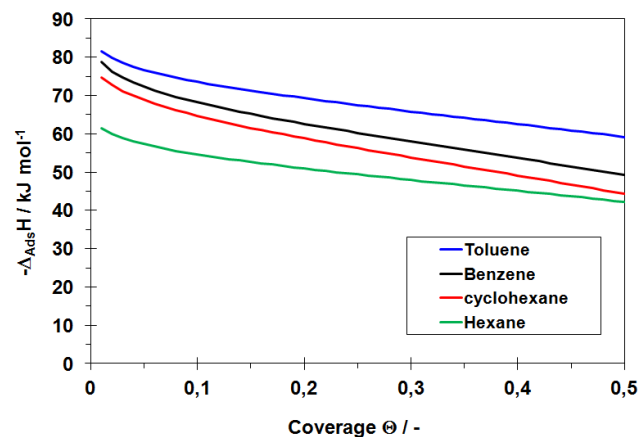

Adsorptive Purification – Lab test: breakthrough curves

- Breakthrough of pure vapors benzene and toluene at 35 °C

Variation of c

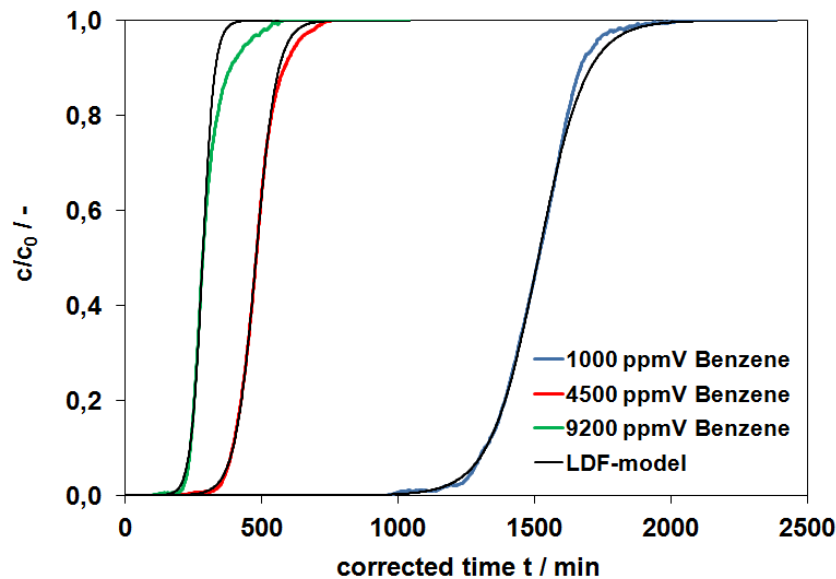

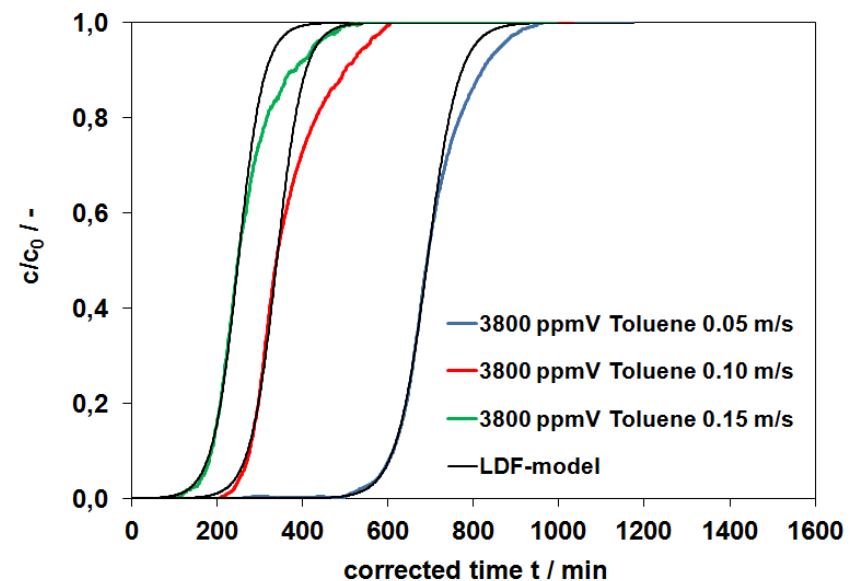

Variation of velocity



- Lower concentration leads to larger breakthrough time
- Higher velocity leads to decrease in breakthrough time

Adsorptive Purification – Lab test: breakthrough curves

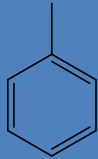
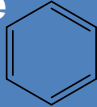
- Determination of k_{LDF} from breakthrough experiments at 35 °C

pure components (constant velocity)	toluene 	benzene 	cyclohexane 	hexane 
~ 1000 ppm $k_{LDF} / 10^{-4} \text{ s}^{-1}$	1.75	1.73	1.94	4.33
~ 4500 ppm $k_{LDF} / 10^{-4} \text{ s}^{-1}$	4.60	4.21	4.27	8.64
~ 9000 ppm $k_{LDF} / 10^{-4} \text{ s}^{-1}$	6.88	7.57	6.72	10.67
Lorimier et al. 2005	3.2 – 5.8			

- k_{LDF} depends on molecular size:

hexane > benzene > toluene/cyclohexane

C. Lorimier, A. Subrenat, L. LeCoq, P. Le Chloirec, Environ. Technol. 26 (2005), 1217-1230.

Adsorptive Purification – Lab test: breakthrough curves

- Breakthrough of mixed vapors benzene/toluene at 35 °C

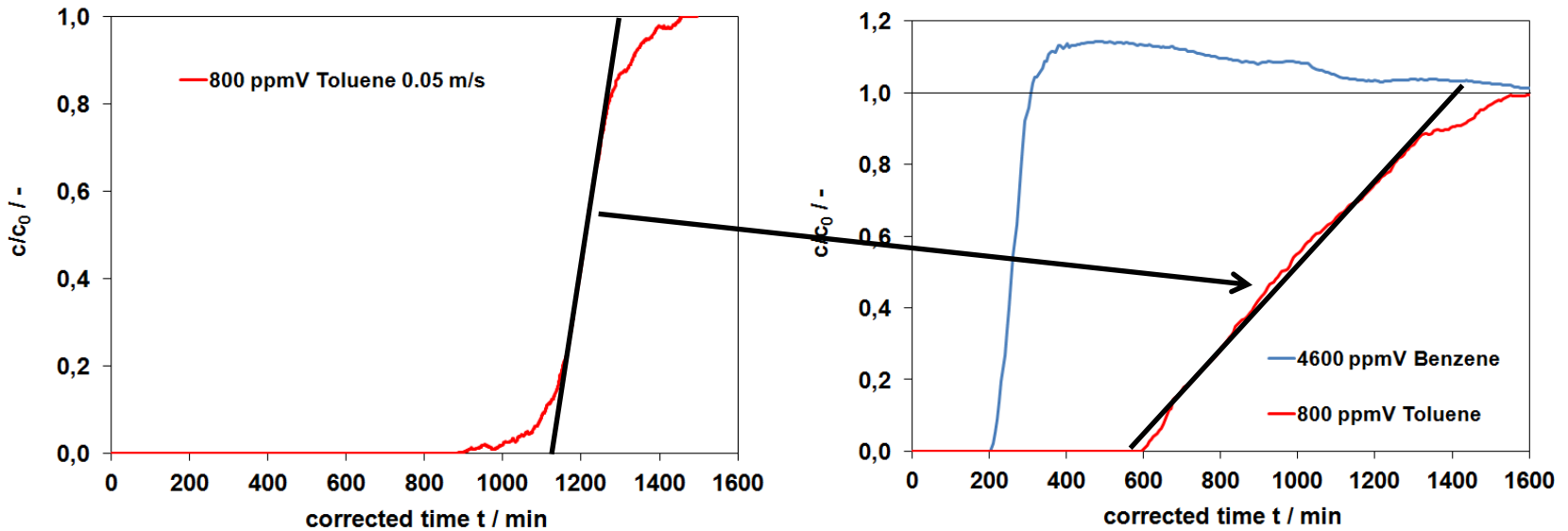

- Benzene is displaced by toluene
- Slope of toluene breakthrough flattens

Adsorptive Purification – Lab test: breakthrough curves

- Breakthrough of mixed vapors benzene/hexane at 35 °C

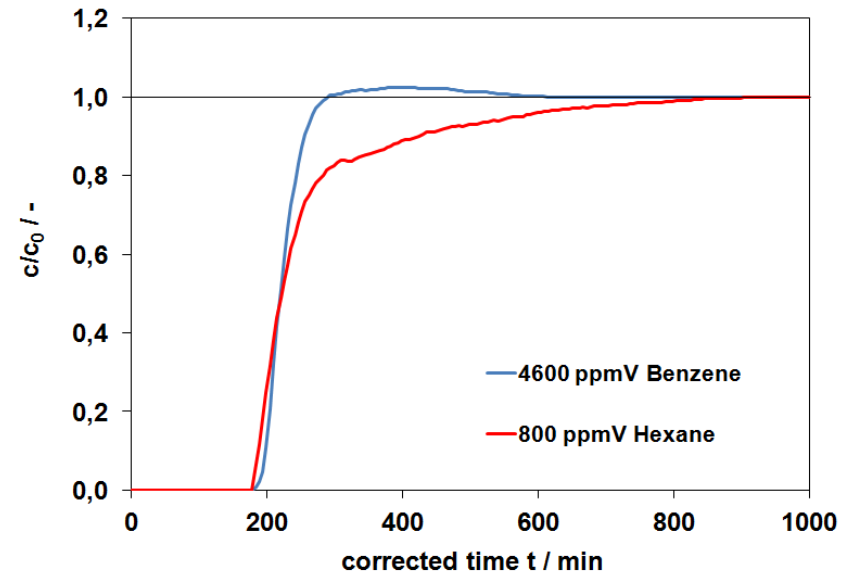
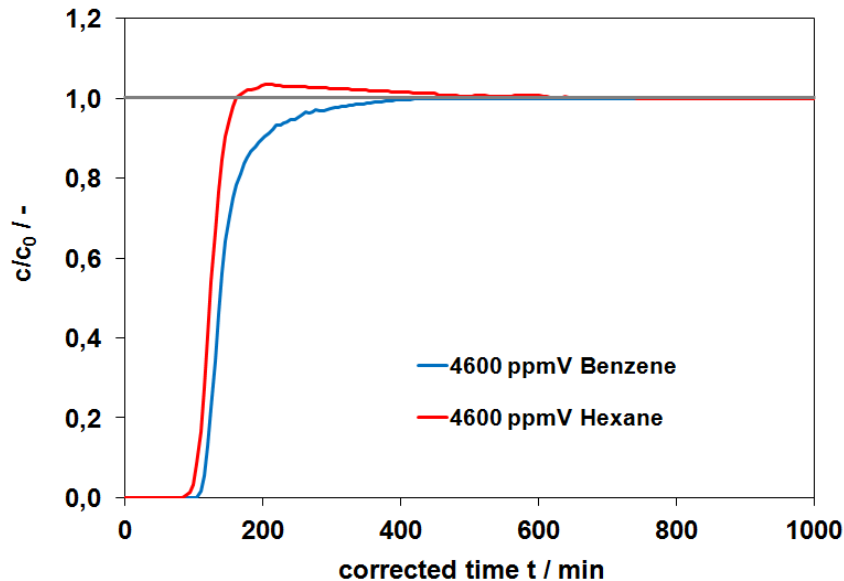

- Benzene is displaced by hexane at low hexane concentration
- Traceable concentration effects

Example II – Effect of humidity to sorption of VOC

Important case of application: Effects of humidity

- Waste air/exhaust air cleaning

→ Humidity depends on conditions at location



<http://www.silica.berlin/de/>

Example II – VOC vs. H₂O sorption on AC

- Completely different sorption behaviour due to difference in physico-chemical properties

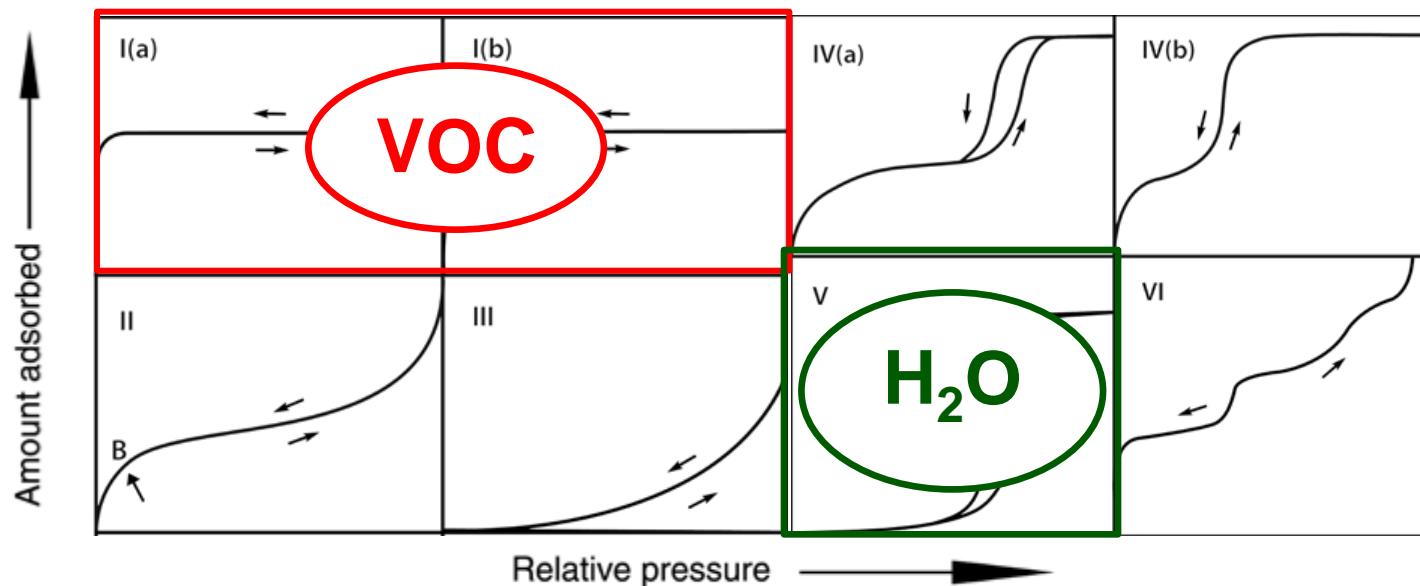

IUPAC Technical Report, Pure Appl. Chem. 2015; 87(9-10), 1051-1069

Breakthrough curve – H₂O

H₂O breakthrough at different concentrations

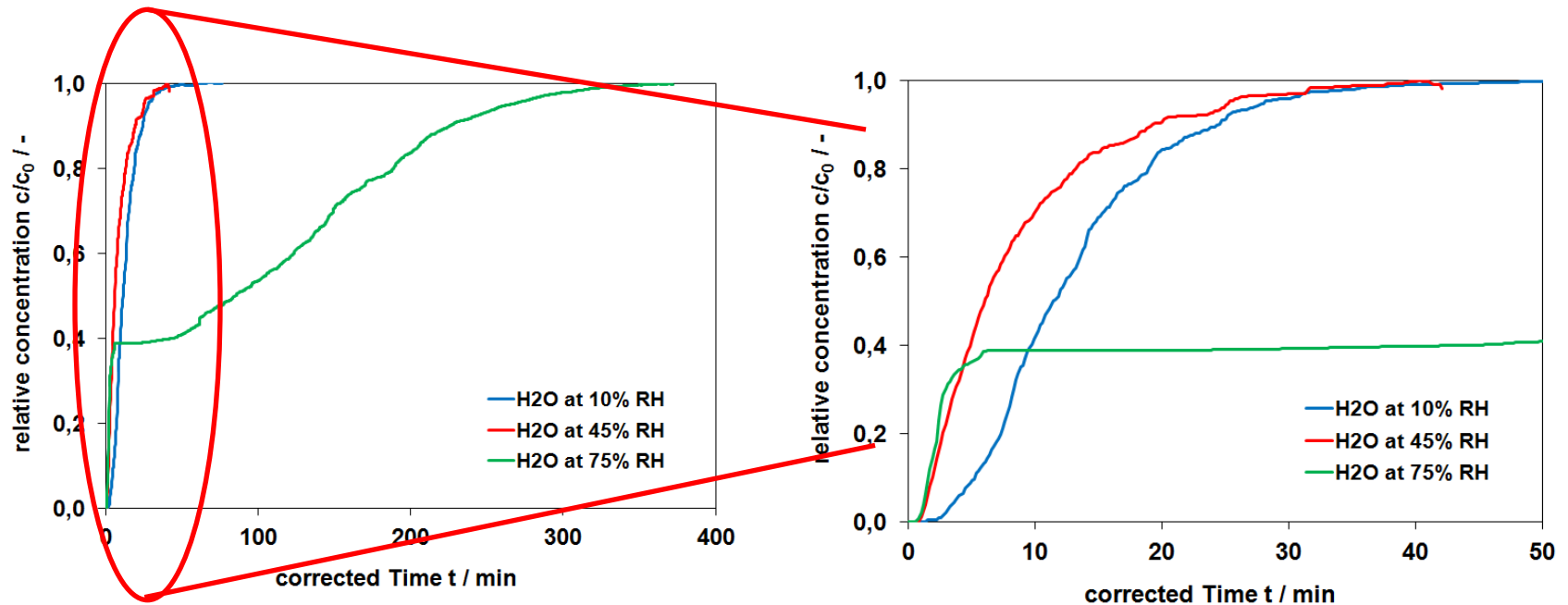

→ H₂O breakthrough below inflection point of isotherm shows typical shape, at higher concentration a stepwise curve is observed due to capillary condensation

Breakthrough curve – H₂O

Below 45% RH

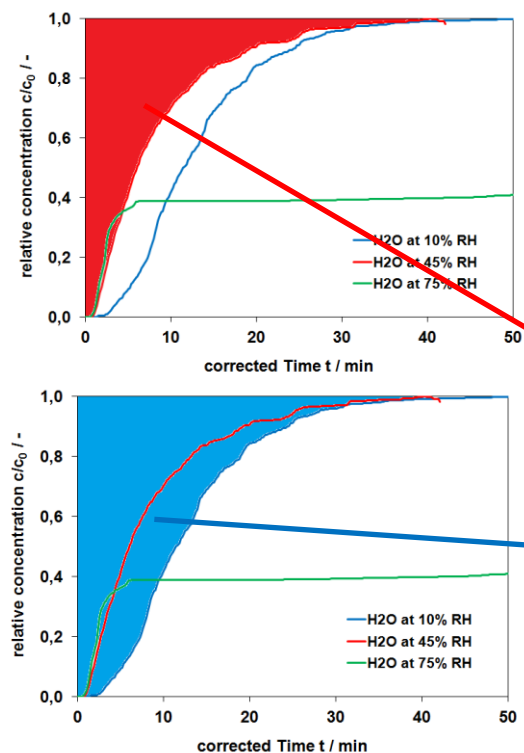

Above 45% RH

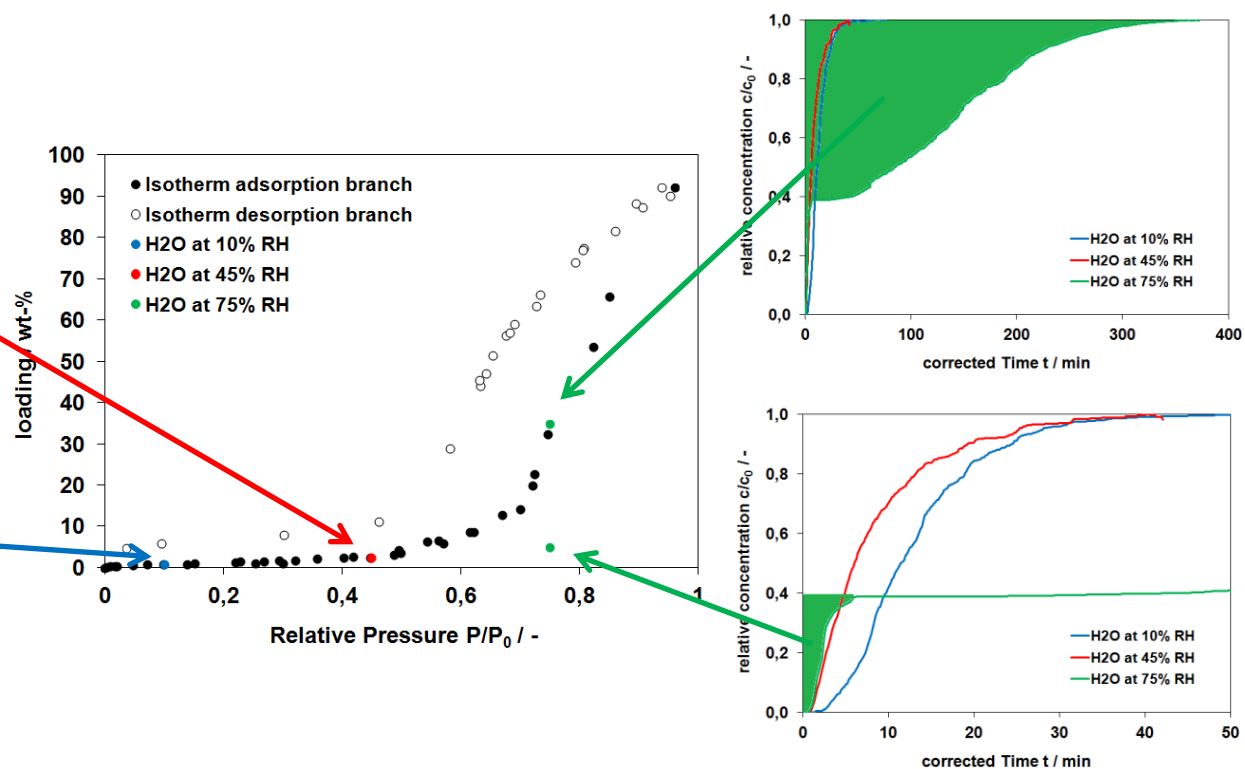

Breakthrough curve – H₂O (low affinity towards AC?)

Type V isotherm is coupled with a low affinity?

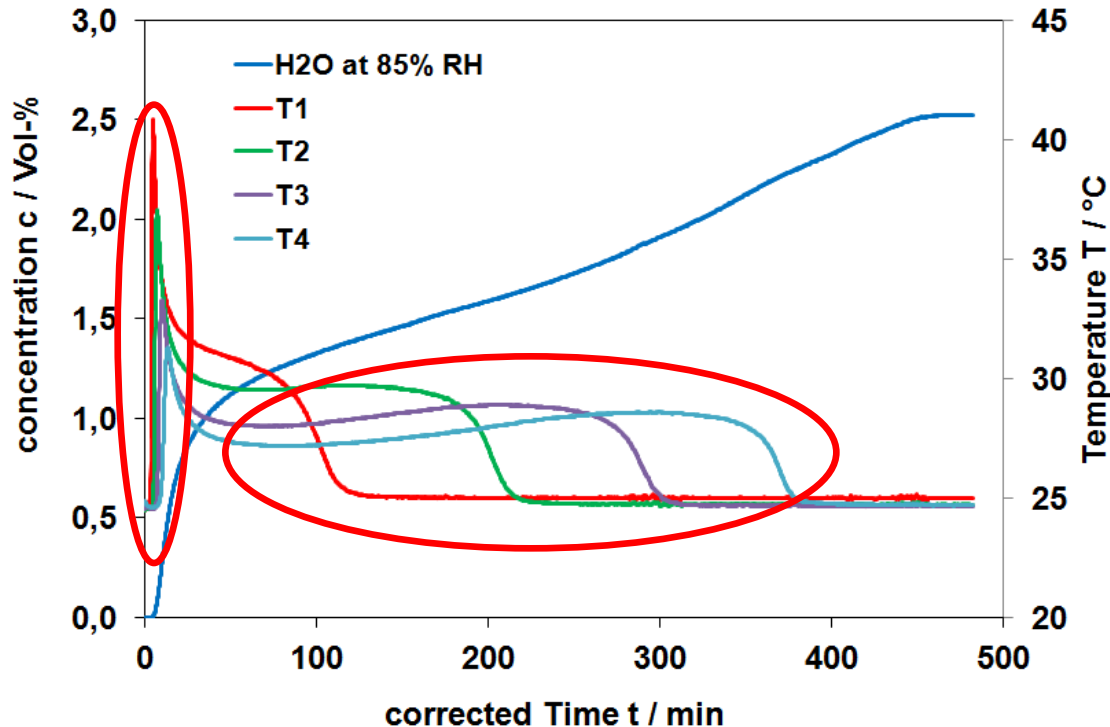

- Strong heat detection during first adsorption due to large interaction of H₂O with ash content of carbon
- Second heat peak is provided by heat of vaporization

Breakthrough curve – Benzene

Benzene capacity is influenced by humidity

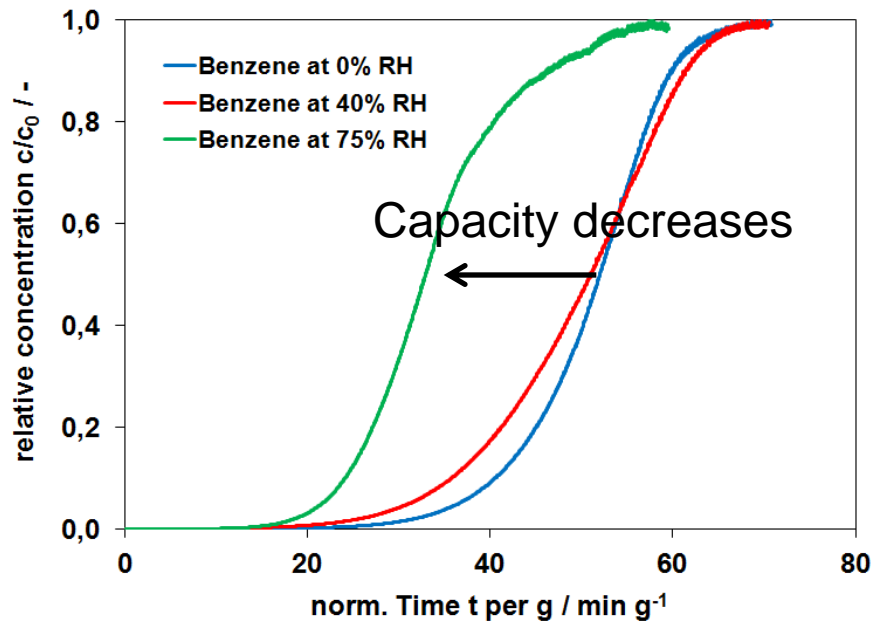

- Benzene breakthrough flattens for low H_2O concentrations
- Benzene capacity decreases with increasing H_2O content

Breakthrough curve – effect of pre-wetting

Benzene capacity is influenced by pre-wetting of the AC in dynamic (breakthrough) experiment

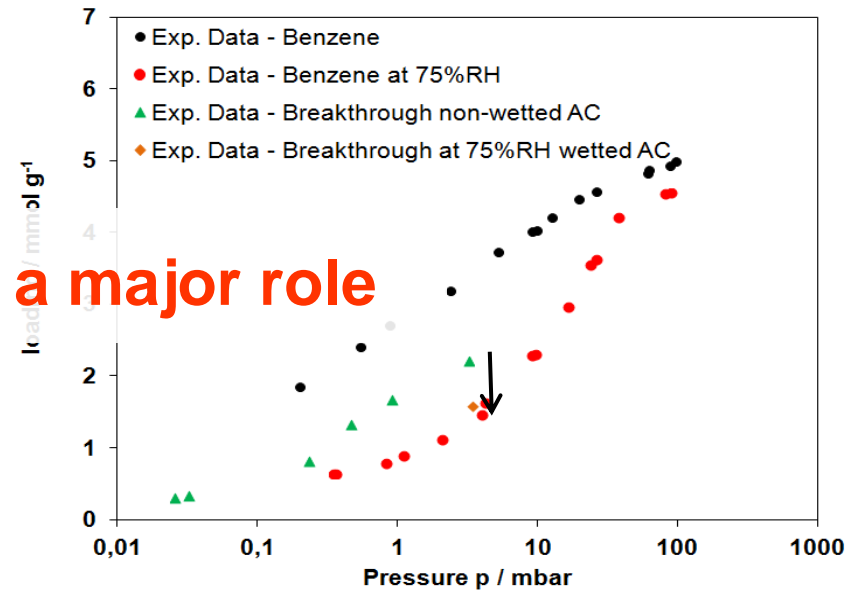
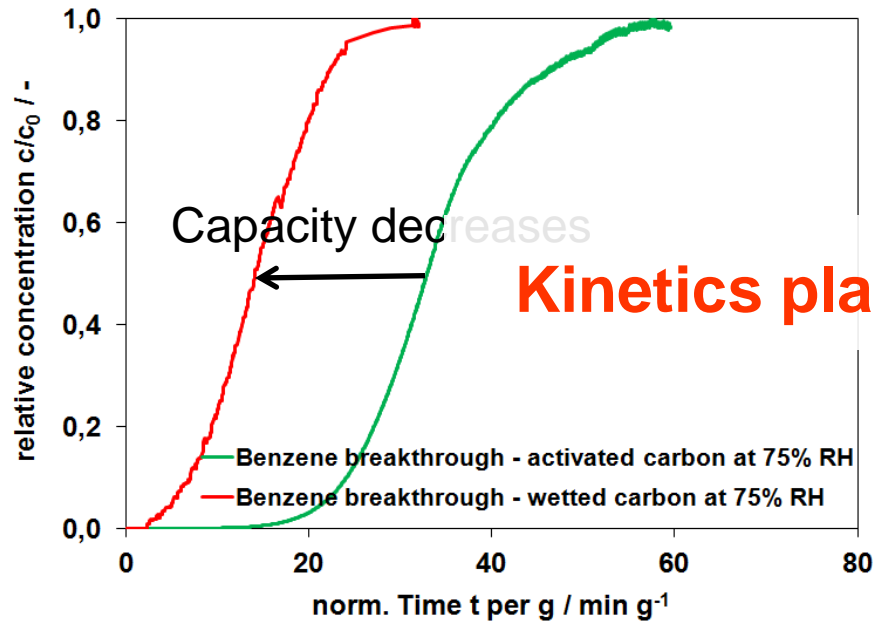

Kinetics play a major role

- Capacity of benzene decreases after pre-wetting the AC
- Long equilibration time for H_2O sorption (due to capillary condensation) leads to an unachievable equilibrium case

Summary II

- Breakthrough test ideal for Process Down-Scaling
 - Check general experimental conditions

- Studying sorption under real conditions
 - Kinetics
 - Thermodynamics
 - Detection of heat effects
 - Competitive sorption (complex mixtures possible)



Acknowledgement



INC Team



Gefördert durch:



Bundesministerium
für Wirtschaft
und Energie

aufgrund eines Beschlusses
des Deutschen Bundestages



DFG Deutsche
Forschungsgemeinschaft



SILICA



<http://research.uni-leipzig.de/inc>

<http://www.dynamicsorption.com/>

Many thanks for your attention!



References

<https://www.helsa.com/helsa-functional-coating/helsa-sorbexx/produkte/helsasorbexx-gs/>
<http://www.adfis.de/index.php/aktivkohle-fur-aktivkohlefilter/>
<http://www.dge-wittenberg.de/>
<http://www.silica.berlin/de/>
<https://www.slideshare.net/SaifullIslam156/adsorption-process-for-voc-volatile-organic-compounds-copy>
<https://www.vdi.de/technik/artikel/abgasreinigung-verfahren-der-katalytischen-abgasreinigung-grundlagen-3/>
<http://www.autobild.de/artikel/katalysator-aufbau-funktion-und-schaeden-8533435.html>
<http://ecolink.com/voc-compliance-strategies/>
<http://www.directindustry.com/prod/brooks-instrument/product-14565-432127.html>
<https://www.pinterest.de/pin/382102349612248994/>
<http://www.agilent.com/home/more-countries?currPageURL=http://www.agilent.com/en-us/products/gas-chromatography/gc-systems/490-micro-gc>

