



## Balkonablauf / Terrassenablauf Typ: HL80

### Technische Daten

<b>Funktion:</b>	Balkon- und Terrassenablauf mit Dichtflansch. Abgang von waagrecht bis senkrecht stufenlos drehbar.
<b>Anschluss:</b>	Ø 50, 75 mm
<b>Abgangsstutzen:</b>	PE-Rohre, steck- und schweisssbar
<b>Abflussvermögen:</b>	48 Liter/Minute
<b>Geruchssperre:</b>	Geruchsverschlussklappe, frostsicher
<b>Belastbarkeit:</b>	Max. 300 kg
<b>Mediumstemp.:</b>	Max. +85°C

### Bestelldaten

Art.-No.:	Bezeichnung	Werkstoff
<b>HL80</b>	<b>Balkon- und Terrassenablauf komplett</b>	
HL037Pr.1E	Einlaufrost 115 x 115 mm	Edelstahl V2A
HL080.4E	Klappeneinsatz	PP
HL037N.2E	Aufsatzrahmen 123 x 123 mm	PP
HL01067D	O-Ring 92 mm x 4 mm	EPDM
HL037N.0E	Baustützrahmen, quadratisch	ABS
HL0300.0EN	Bauschutzdeckel, rund	ABS
HL80K	Ablaufkörper	PE

### Abmessungen [mm]

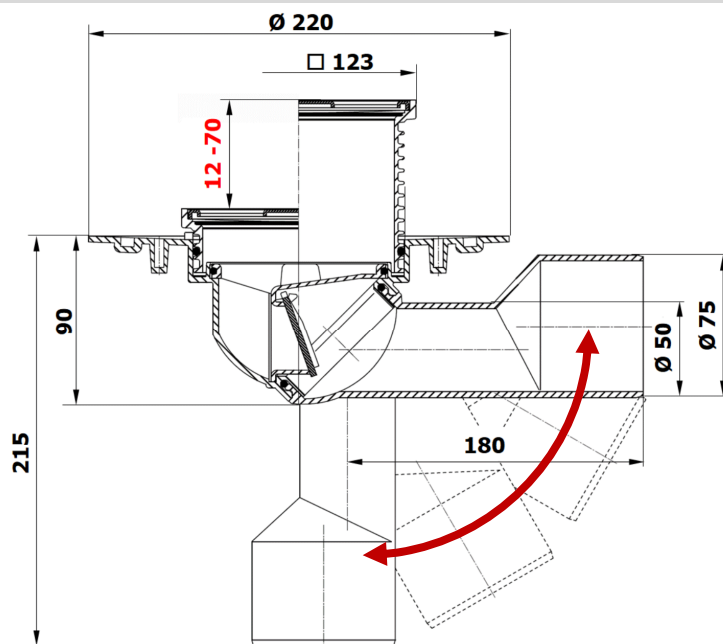

**Abgangsstutzen 90° schwenkbar**

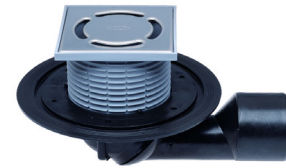

HL80



Einlaufrost



Klappeneinsatz



Aufsatzrahmen  
ablängbar (12 - 70 mm)



O-Ring



Baustützrahmen / Bauschutzdeckel



Ablaufkörper



## Balkonablauf / Terrassenablauf HL80 Zubehör

### Bestelldaten

Art.-No.:	Bezeichnung	Werkstoff
HL83.H	Abdichtgarnitur ø Metallring aussen = 196 mm Manschette = 500 x 500 mm	<b>Bitumen</b>
HL83.M	Abdichtgarnitur ø Metallring aussen = 196 mm Manschette = 400 x 400 mm (für 2-Komponenten Epoxidharze)	<b>vlieskaschierte Folie</b>
HL83	Abdichtgarnitur ø Metallring aussen = 196 mm Manschette = 400 x 400 mm	<b>EPDM</b>
HL83.P	Dichtflansch ø aussen = 290 mm, ø innen = 114 mm	<b>PVC</b>
HL83.PP	Dichtflansch ø aussen = 290 mm, ø innen = 114 mm	<b>PP</b>
HL83.0	Klemmelement ø aussen = 196 mm, ø innen = 114 mm	<b>V2A</b>
HL619	Befestigungsglaschen FixIT	<b>Edelstahl</b>
HL85N	Aufstockelement ø Dichtflansch = 220 mm ø Verlängerung = 110 mm H = 200 mm ablängbar	<b>PP</b>
HL85NH	Aufstockelement mit Manschette ø Manschette = 420 mm ø Verlängerung = 110 mm H = 200 mm ablängbar	<b>PP Bitumen</b>
HL340N	Aufstockelement ø Verlängerung = 110 mm H = 100 mm ablängbar	<b>PP</b>
HL3000	Aufsatzrahmen 121 x 121mm	<b>VA</b>
HL180	Entwässerungsring ø aussen = 125 mm, ø innen = 110 mm H = 39 mm	<b>PP</b>
HL181	Kiesfang, Laubfang ø aussen = 122 mm, ø innen = 110 mm H = 10 mm	<b>PP</b>
HL3120-27	Einlaufrost 115 x 115 mm	<b>Edelstahl V4A</b>

### Weiteres Zubehör auf Anfrage

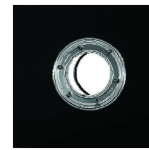

HL83.H, HL83.M, HL83



HL83.P, HL83.PP



HL83.0



HL619



HL85N

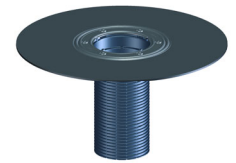

HL85NH



HL340N



HL3000



HL180

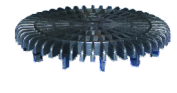

HL181

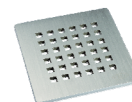

HL3120

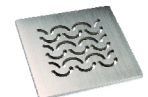

HL3121



HL3122



HL3123



HL3124



HL3125



HL3127