

**KLS martin**  
GROUP



Neurochirurgie  
Neurosurgery  
Neurocirugía  
Neurochirurgie  
Neurochirurgia

**Neuro**



# Chirurgische Instrumente



Seit 1896





Surgical Innovation is our Passion



# Chirurgische Innovation ist unsere Leidenschaft

Wie kommt man dazu, über 12.500 chirurgische Instrumente zu entwickeln, zu fertigen und zu vermarkten? Produkte, die sich durch klare Alleinstellungsmerkmale auszeichnen. Es ist die Leidenschaft, neue Wege zu finden, die Menschen helfen und der Gesundheit dienen.



EN

## **Surgical Innovation is our passion**

What is the secret behind the development, manufacture and distribution of over 12,500 exclusive surgical instruments, products whose distinguishing characteristics truly set them apart from all the others? The answer is passion, the overwhelming desire to discover new ways of serving humankind in its search for ultimate health.

ES

## **La innovación quirúrgica es nuestra pasión**

¿Cómo es posible concebir, producir y comercializar más de 12.500 instrumentos quirúrgicos? Estamos hablando de productos que se caracterizan por unas propiedades exclusivas, claramente definidas. La clave está en que nos motiva la pasión por encontrar nuevos caminos para ayudar a las personas y fomentar la salud.

FR

## **Notre passion est l'innovation chirurgicale**

Comment est-il possible de développer, fabriquer et commercialiser plus de 12.500 instruments chirurgicaux ? Des produits dont les caractéristiques distinctives sont leur position unique sur le marché. Et bien, ceci est en fait dû à la passion de vouloir trouver de nouvelles méthodes afin de venir en aide aux personnes et de servir la santé.

IT

## **L'innovazione nella chirurgia è la nostra passione**

Che cosa ci spinge a progettare, produrre e distribuire più di 12.500 strumenti chirurgici dalle caratteristiche uniche? Sono la nostra passione e il desiderio di aiutare il prossimo e cercare nuove vie per migliorare la salute.



Am Anfang stand die Vision, aus kleinen Firmen eine international agierende Unternehmensgruppe zu bilden. Seit 1896 widmen wir uns der Chirurgie. Heute beschäftigt die KLS Martin Group über 2.000 Mitarbeiter und ist einer der weltweit führenden Konzerne für Entwicklung, Produktion und Vertrieb medizintechnischer Produkte, die in enger Zusammenarbeit mit denjenigen entwickelt werden, die sie letztlich einsetzen: den Chirurgen.

EN

#### **In the beginning there was a vision**

Our vision was to create an internationally operating group of companies from a handful of smaller businesses. Since 1896 we have been dedicated to surgery. Today, the KLS Martin Group has a staff of over 2.000 and is one of the leading globally acting enterprises for the development, manufacture and distribution of medical devices. We work hand in hand with those holding the scalpel: the surgeons.

ES

#### **Todo comienzo parte de una visión**

Al principio la visión consistía en conformar, a partir de pequeñas empresas, un grupo empresarial con intervención a escala mundial. Desde 1896 nos hemos dedicado a la cirugía. Hoy en día, el KLS Martin Group da trabajo a más de 2.000 personas y se encuentra a nivel mundial entre los consorcios líderes dedicados al desarrollo, producción y comercialización de productos medicotécnicos, diseñados en estrecha colaboración con aquel grupo de personas que finalmente los emplean: los cirujanos.

FR

#### **Tout commença par une vision**

Au début, en naquit la vision de pouvoir former un groupe d'entreprises à activités internationales à partir de petites entreprises. Depuis 1896, nous nous consacrons à la chirurgie. Le groupe KLS Martin Group occupe actuellement plus de 2.000 employés et il est l'un des groupes leaders sur le marché mondial dans le secteur du développement, de la production et de la commercialisation de produits médico-techniques, ces produits ayant été développés en étroite collaboration avec ceux les utilisant, c'est-à-dire les chirurgiens.

IT

#### **All'inizio c'era una visione**

All'inizio c'era una visione: fondere piccole ditte per creare un gruppo aziendale operante a livello internazionale. Dal 1896 ci dedichiamo alla chirurgia. Oggi il KLS Martin Group ha più di 2.000 dipendenti ed è una delle imprese leader al mondo nella progettazione, produzione e distribuzione di prodotti medicali creati in stretta collaborazione con gli utenti finali: i chirurghi.



Am Anfang  
stand eine Vision





## Qualitätssicherung ohne Kompromisse

Unsere Produkte erfüllen den Anspruch anwendungsbezogener Funktionalität, intelligenter Handhabung und hoher Qualität. Und wenn es um die Erfüllung dieses Anspruchs geht, machen wir keine Kompromisse. Um dies zu gewährleisten, unterhält KLS Martin ein eigenes hochmodernes Labor sowie ein Technikum, in denen die Qualität unserer Erzeugnisse – auch unter extremen Bedingungen – auf „Herz und Nieren“ getestet und dokumentiert werden.

EN

### Quality assurance uncompromising

Our products are designed to consistently meet high demands for application-oriented functionality, intelligent operation and top quality. And we are not prepared to compromise when it comes to meeting the justified expectations of our customers, present and future – your standards become ours. KLS Martin runs their own ultramodern laboratories and a pilot plant, where our products are stress-tested under extreme conditions – every step is documented before release.

ES

### Un seguro de calidad sin compromisos

Nuestros productos cumplen el requisito de estar dotados de la funcionalidad conforme a su aplicación, su manipulación es inteligente y son de alta calidad. No transigimos a la hora de cumplir con estas condiciones esenciales. Por este motivo, KLS Martin mantiene un laboratorio propio, altamente moderno, así como una escuela técnica, donde se ensaya y documenta la calidad de nuestros productos – inclusive bajo condiciones extremas –, examinándolos “hasta la médula”.

FR

### Une assurance qualité sans compromis

Nos produits répondent aux exigences requises par une fonctionnalité relative à l'application, un maniement intelligent et une qualité élevée. Et nous n'acceptons aucun compromis lorsqu'il s'agit de répondre à ces exigences. KLS Martin possède à ce but son propre laboratoire ultramoderne et son centre technique dans lesquels la qualité de nos produits fabriqués est testée minutieusement – même sous des extrêmes conditions – et les résultats des tests sont documentés.

IT

### Assicurazione della qualità senza compromessi

I nostri prodotti sono stati progettati guardando alle esigenze della prassi applicativa, offrono una manipolazione intelligente e sono di qualità elevata. A tale riguardo non facciamo compromessi. Per garantire questo standard, KLS Martin ha un laboratorio altamente moderno e un centro tecnologico in cui controlla e documenta la qualità di tutti i prodotti, anche in condizioni estreme.

## Wir setzen Standards für die Instrumentenaufbereitung

Wie lassen sich Medizinprodukte vor mechanischer, thermischer oder chemischer Belastung schützen? Was muss man bei der Aufbereitung und Pflege besonders feingliedriger Mikrochirurgie-Instrumente berücksichtigen? Als Mitglied wichtiger Gremien und Arbeitskreise – wie z. B. dem Arbeitskreis Instrumenten-Aufbereitung AKI – gibt KLS Martin Antworten und erarbeitet Lösungen für die optimale Aufbereitung und Pflege von Instrumenten. Von der Auswahl angemessener Reinigungsverfahren bis hin zu Sterilisationsverfahren.

EN

### Standards and best practice: instrument preparation

How best to protect surgical instruments from mechanical, thermal and chemical stresses? What steps are performed to ensure optimal preparation and care of highly delicate microsurgical instruments? KLS Martin, in their capacity as member of important advisory boards and working groups – for example, Working Group Instrument Preparation AKI – is in a position to provide answers and solutions to all inquiries with regard to the optimal preparation and care of instruments, ranging from knowledgeable advice on appropriate cleaning methods through sterilization processes.

ES

### Los estándares y la mejor práctica para la preparación de instrumentos

¿Cómo se pueden proteger los productos médicos contra la actuación de factores mecánicos, térmicos y químicos? ¿Qué es lo que hay que considerar en el momento de preparación y cuidado del instrumental microquirúrgico, constituido fundamentalmente por componentes finos? En función de miembro de asociaciones y comités laborales importantes – como por ejemplo, el Comité Alemán de Trabajo de Preparación de Instrumental AKI – KLS Martin ofrece respuestas y elabora soluciones para el tratamiento y cuidado óptimos del instrumental. Éstas abarcan desde la selección de métodos de limpieza adecuados hasta el procedimiento de esterilización.

FR

### Normes et pratiques idéales pour la préparation des instruments

Comment protéger les produits médicaux contre d'éventuelles contraintes mécaniques, thermiques ou chimiques? Quels points doivent être pris en considération pour le traitement et l'entretien d'instruments micro-chirurgicaux à fine ossature? A titre de membre d'importants organismes et cercles de travail, tels que par exemple l'AKI (Arbeitskreis Instrumenten-Aufbereitung = cercle de travail pour le traitement des instruments), KLS Martin donne des réponses et élabore des solutions pour assurer un traitement et un entretien optimaux des instruments. Depuis la sélection de procédés de nettoyage adéquats jusqu'au procédé de stérilisation.

IT

### Standard e “best practice” per la preparazione degli strumenti

Come si possono proteggere gli strumenti medici da agenti aggressivi di tipo meccanico, termico o chimico? Cosa occorre tenere presente nella preparazione e nella manutenzione di strumenti microchirurgici particolarmente delicati? Quale membro di importanti organi e gruppi di lavoro, come ad esempio AKI, il gruppo tedesco di lavoro per la corretta preparazione degli strumenti, KLS Martin dà risposta e sviluppa soluzioni per la preparazione e la manutenzione ottimali degli strumenti, dalla scelta dei sistemi di pulizia più idonei alle procedure di sterilizzazione.

Die Verantwortung für die Reinigung, ... liegt beim Betreiber / Produktanwender. Nationale Regelungen, ... müssen unbedingt beachtet werden.

Wir empfehlen die in den Kapiteln 4.2 bis 4.8 beschriebenen Verfahren für die Initialaufbereitung unserer wiederverwendbaren chirurgischen Instrumente.

**4.2 Maschinelle Reinigung**

**4.2.1 Allgemeine Hinweise**

Die Instrumentenreinigung und -desinfektion in den Reinigungsautomaten ist immer der vollen Reinigung vorzuziehen, da maschinelle Verfahren standardisierbar sind. Die Anweisungen der Hersteller sind zu beachten. Es sollten nur die Anwendungszwecke empfohlen...

**Instructions for Use**

**We offer the Option of requesting Instructions for Use for your KLS Martin Product online.**

Included are all manufacturers' data according to DIN EN ISO 17664.



Lebenslange Garantie  
für MARTIN-Instrumente



## Lebenslange Garantie – wann immer Sie sie brauchen

Keine Frage, wir sind stets auf der Suche nach der noch besseren Lösung. Das zeichnet den kontinuierlichen Fortschritt in unserem Produktportfolio aus. Gleichwohl sind alle unsere Instrumente qualitativ erstklassig und werden höchsten Ansprüchen gerecht. Und weil wir davon überzeugt sind, gewähren wir auf jedes Instrument bei sach- und fachgerechtem Einsatz eine lebenslange Garantie.

EN

### **Whenever you need it – our lifetime guarantee**

Our determined and ongoing search for the perfect solution is reflected in the dynamic nature of our product portfolio. You simply will not find better instruments on the market. And because we truly believe in the outstanding quality of our products, we offer a lifelong guarantee on each instrument, in connection with appropriate and professional use.

ES

### **Necesite lo que necesite – la garantía es de por vida**

Lo cierto es que siempre estamos en la búsqueda de una solución que sea aún mejor. Esto es lo que determina el progreso continuado de nuestra cartera de producción. Todos nuestros instrumentos son de la misma calidad máxima cumpliendo, por lo tanto cumplen con los requisitos más exigentes. Y como estamos convencidos de ello, garantizamos en todo nuestro instrumental una garantía de por vida, siempre y cuando se utilice como es debido y según las normativas.

FR

### **Si jamais vous en avez besoin – notre garantie à vie**

Nous sommes, sans aucun doute, toujours à la recherche de la solution optimale. Ce fait caractérise le progrès continu dans notre porte-feuille de produits. Tous nos instruments sont à la fois de toute première qualité et conformes à des exigences maximales. Et étant donné ce fait, nous garantissons sur chaque instrument une garantie à vie, à condition que les instruments soient utilisés de manière adéquate et compétente.

IT

### **Ogni qual volta ne avete bisogno – la nostra garanzia a vita**

Essendo alla ricerca di soluzioni sempre migliori, i nostri prodotti vengono costantemente migliorati. Essi sono di qualità eccellente e soddisfano persino le esigenze più elevate. Per questo possiamo accordare una garanzia a vita per ogni strumento impiegato in modo appropriato e corretto.

## Instrumente schneller finden – die Katalog-Handhabung

Es ist ganz einfach: Die Artikelnummer gibt Auskunft über Produkt, Produktgruppe und Größe/Figur des Instruments. Jedes Produkt wird in Größe und Funktion vollständig beschrieben sowie maßstabsgetreu abgebildet – die Arbeitsenden je im Verhältnis 1 : 1. So finden Sie schneller, was Sie wirklich brauchen.



EN

### Finding the instruments you need – how to use the catalogue

Straightforward and easy: The article number informs you about the product, product group and instrument size. Size and function of each product are described in full detail and illustrated to scale – the working ends in a ratio of 1 : 1. You can quickly find exactly what you are looking for.

ES

### Encuentre el instrumental que necesita – modo de consultar el catálogo

Es muy simple: El número de artículo facilita una información acerca del producto, el grupo de producto y el tamaño del instrumental. Encontrará la descripción completa de tamaño y función de cada producto y una ilustración a escala; los extremos funcionales aparecerán en relación 1 : 1. Así Ud. podrá encontrar más rápidamente lo que realmente necesita.

FR

### Comment trouver les instruments requis – l'utilisation du catalogue

C'est tout simple : Le numéro d'article fournit des informations sur le produit, le groupe de produits et la taille de l'instrument. Une description détaillée de la taille et du fonctionnement de chaque produit est fournie et tous les produits sont illustrés à l'échelle – les extrémités des instruments étant illustrées au rapport 1 : 1. Ainsi vous trouvez plus rapidement ce dont vous avez vraiment besoin.

IT

### Trovare gli strumenti che cercate – i cataloghi

È semplicissimo: Il codice articolo fornisce informazioni sul prodotto, sulla categoria e sulla grandezza dello strumento. Il catalogo presenta una descrizione dettagliata di ciascun prodotto, delle sue dimensioni e funzioni nonché un'illustrazione in scala degli strumenti, le cui estremità sono riprodotte in rapporto 1 : 1. In questo modo trovate più velocemente ciò di cui avete veramente bisogno.



Abbildungsmaßstab  
Illustration scale  
Los productos en escala  
Produits à l'échelle  
Prodotti dimensioni

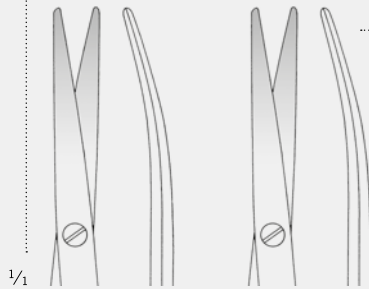

Arbeitsenden  
Working end  
El extremo funcional  
del producto  
Extrémité opératoire  
du produit  
L'estremità funzio-  
nale del prodotto

Autor (wenn vorhanden)  
Author (if available)  
Autor (si lo hay)  
Auteur (s'il existe)  
Autore (se disponibile)

11-339-12-07  
12,5 cm / 5"  
feines Modell  
fine pattern  
modelo fino  
modèle fin  
modello delicato

11-339-18-07  
18 cm / 7"  
feines Modell  
fine pattern  
modelo fino  
modèle fin  
modello delicato

Salyer  
11-339-12-07 –  
11-339-18-07

Angaben zum Produkt  
Product information  
Datos sobre el producto  
Données sur le produit  
Indicazioni relative al  
prodotto

für Lippen-, Kiefer-, Gaumenspalte  
for Cleft Palate  
para fisura paladar  
pour fente du palais  
per cheilo-labbro-palatoschisi

Maße  
Dimensions  
Dimensiones  
Dimensions  
Dimensioni

|    | Materialart  | Material type   | Tipo de material   | Type de matériau   | Tipo di materiale  |
|----|--|---|--|--|--|
| 01 | Stahl 18/8 martinit,<br>antimagnetisch,<br>rostfrei,<br>säurebeständig | steel 18/8 martinit,<br>antimagnetic,<br>stainless,<br>acid-resistant | acero 18/8 martinit,<br>antimagnético,<br>inoxidable,<br>resistente a los ácidos | acier 18/8 martinit,<br>antimagnétique,<br>inoxydable,<br>résistant aux acides | acciaio 18/8 martinit,<br>antimagnetico,<br>inossidabile,<br>resistente agli acidi |
| 02 | verchromt  | chrome-plated   | cromado  | chromé   | cromato  |
| 04 | alle übrigen,<br>nicht besonders<br>gekennzeichneten<br>Materialarten  | all other,<br>not specially<br>marked<br>material types               | todos los otros<br>tipos de materiales<br>no identificados<br>de forma especial  | tous les autres<br>types de matériau<br>sans marquage<br>spécial               | tutti gli altri<br>tipi di materiali<br>senza marcatura<br>speciale                |
| 07 | rostfreier Stahl   | stainless steel   | acero inoxidable   | acier inoxydable   | acciaio inossidabile   |
| 08 | Silber   | silver  | plata  | argent   | argento  |
| 09 | Titan  | titanium  | titanio  | titane   | titanio  |
| 14 | Solid Black  | Solid Black   | Solid Black  | Solid Black  | Solid Black  |
| 98 | Ersatzteil   | replacement part  | pieza de repuesto  | pièce de rechange  | pezzo di ricambio  |

# Erläuterungen zum Katalog

Catalog explanations

Explicaciones complementarias al catálogo

Explicacions sur le catalogue

Spiegazioni relative al catalogo



Verweis · Reference · Referencia  
Référence · Rimando



Für Fig. Nr. · for fig. No.  
para fig. No. · pour fig. No.  
per fig. N.



Schneidenlänge · cutting edge length  
longitud de hojas cortantes  
longueur de lames · lunghezza di lame



Schnittlänge · cutting length  
longitud de corte · longueur de coupe  
lunghezza di taglio



Anzahl Zähne · number of teeth  
cantidad de dientes · quantité de dents  
quantità di denti



Anzahl Zinken · number of teeth  
cantidad de dientes · quantité de dents  
quantità di denti



Spreizweite · spreading width  
extensión · écartement  
apertura



Fadenstärke · thread size  
grosor de hilos · grosseur de fils  
spessore di fili



De Bakey  
Zahnung · serration · dentado  
denture · dentatura



Cooley  
Zahnung · serration · dentado  
denture · dentatura



Cooley  
Zahnung · serration · dentado  
denture · dentatura



Schließkraft · closing pressure ·  
fuerza de oclusión · pression de fermeture  
pressione di chiusura



Schaftlänge · shaft length  
longitud del vástago · longueur du tige  
lunghezza del gambo



Edelstahl · stainless steel  
acero inoxidable · acier inoxydable  
acciaio inossidabile



Titan · titanium · titanio  
titane · titanio



Aluminium · aluminum · alluminio  
aluminium · alluminio



Silikon · Silicone  
Silicona · Silicone · Silicene



Kaltlicht · cold light · luz fría  
lumière froide · luce fredda



Solid Black  
Hartstoffbeschichtung  
(für eine längere Standzeit)  
Hard-coated surface  
(for extended life)  
Recubrimiento con material duro  
(para una vida útil más larga)  
Revêtement à surface dure  
(pour une durée de vie prolongée)  
Rivestimento in materiale rigido  
(per una più lunga durata)

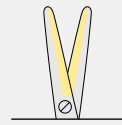

**TC GOLD**

TC-Hartmetall im Arbeitsende  
Tungsten carbide in working end  
Carburo de tungsteno en el extremo de trabajo  
Carbure de tungstène sur extrémité de travail  
Carburo di tungsteno nell'estremità operativa

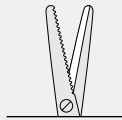

**SuperCut**

Wellenschliff/Messerschliff  
Serrated edge/knife edge  
Filo ondulado/filo de cuchillo  
Affûtage dentelé / Affûtage couteau  
Taglio ondulato/taglio coltello

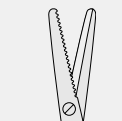

**ST**

Wellenschliff/Scherenschliff  
Serrated edge/scissor edge  
Filo ondulado/filo de tijeras  
Affûtage dentelé/affûtage ciseaux  
Taglio ondulato/taglio forbici

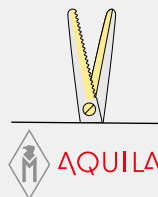

**AQUILA**

TC-Hartmetall mit  
Messerschliff/Wellenschliff  
Tungsten carbide with  
knife edge/serrated edge  
Carburo de tungsteno con filo de  
cuchillo/filo ondulado  
Carbure de tungstène avec affûtage  
couteau/affûtage dentelé  
Carburo di tungsteno con  
taglio coltello/taglio ondulato



**TCC BlackLine**

TC-Hartmetall mit Messerschliff/  
Wellenschliff, Solid-Black-beschichtet  
Tungsten carbide with knife edge/  
serrated edge, Solid Black coated  
Carburo de tungsteno con filo de cuchillo/filo  
ondulado, recubrimiento Solid Black  
Carbure de tungstène avec affûtage couteau/  
affûtage dentelé, revêtement Solid Black  
Carburo di tungsteno con taglio coltello/  
taglio ondulato, rivestito in Solid Black



**sutureCut**

Nahtmaterialschere  
Suture material scissors  
Tijeras para material de sutura  
Ciseaux à suture  
Forbici per materiale di sutura

**finoLine**

Schlanke Modelle  
Slim models  
Modelos estilizados  
Modèles minces  
Modelli sottili

## TC GOLD

Instrumente mit Hartmetalleinlagen  
 Instruments with tungsten carbide inserts  
 Instrumentos con filos de carburo de tungsteno  
 Instruments avec plaquettes en carbure de tungstène  
 Strumenti con taglio in carburo di tungsteno

## STERILE R

mit Gamma-Strahlen sterilisierte Produkte  
 with gamma radiation sterilized products  
 productos esterilizados con rayos gamma  
 produits stérilisés avec de rayons gamma  
 prodotti sterilizzati con raggi gamma



Diamantierte Arbeitsenden  
 Diamond-coated working ends  
 Extremos de trabajo diamantados  
 Extrémités de travail diamantées  
 Estremità operative diamantate



Safety-Wave-Sicherheitsschluss  
 Safety-Wave safety pivot  
 Cierre de seguridad Safety-Wave  
 Fermeture sécurisée Safety-Wave  
 Arresto di sicurezza Safety-Wave



Counter Balance

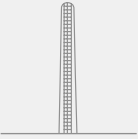

Atrauma-Zahnung  
 Atraumatic serration  
 Dentado atraumático  
 Dentelure Atrauma  
 Dentatura atraumatica



Gefäßdilatoren  
 Vessel dilators  
 Diladores vasculares  
 Pincers à dilatation de vaisseaux  
 Dilatori vascolari



scharf  
 sharp  
 agudo  
 pointu  
 acuto



halbscharf  
 semi-sharp  
 semi-agudo  
 semi-pointu  
 semi acuto



stumpf  
 blunt  
 romo  
 mousse  
 smusso

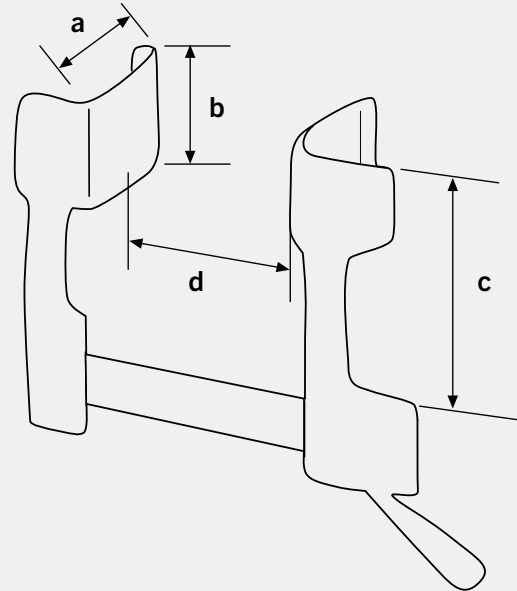

**a** = Valventiefe  
 Blade depth  
 Profundidad de valva  
 Profondeur de valve  
 Profondità della valva

**c** = Armlänge  
 Arm length  
 Longitud de brazo  
 Longueur de bras  
 Lunghezza del braccio

**b** = Valvenbreite  
 Blade width  
 Anchura de valva  
 Largeur de valve  
 Larghezza della valva

**d** = Spreizweite  
 Spreading width  
 Anchura de extensión  
 Largeur d'ouverture  
 Ampiezza di apertura

| Pyramiden-Profil<br>Diamond profile<br>Perfil piramidal<br>Profil pyramidal<br>Profilo piramidale | Teilung<br>Profile structure<br>División<br>Division<br>Divisione | empfohlen für Nahtmaterial<br>recommended for suture material<br>recomendado para suturas<br>recommandé pour matériel de suture<br>raccomodato per materiale di sutura |
|---|---|--|
|---|---|--|

|                 |               |                  |
|-----------------|---------------|------------------|
| <b>Standard</b> | <b>0,5 mm</b> | <b>0-6 - 4-0</b> |
|-----------------|---------------|------------------|

|             |               |                  |
|-------------|---------------|------------------|
| <b>Mini</b> | <b>0,4 mm</b> | <b>4-0 - 6-0</b> |
|-------------|---------------|------------------|

|              |               |                   |
|--------------|---------------|-------------------|
| <b>Micro</b> | <b>0,3 mm</b> | <b>5-0 - 12-0</b> |
|--------------|---------------|-------------------|

|               |   |                   |
|---------------|---|-------------------|
| <b>Smooth</b> | – | <b>5-0 - 12-0</b> |
|---------------|---|-------------------|



Übersichtstafel  
Table of Contents  
Tabla de catálogo  
Contenu  
Indice di catalogo



# Übersichtstafel

Table of Contents

Tabla de catálogo

Contenu

Indice di catalogo

1-21

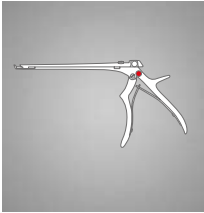

Laminektomiestanzen und Rongeure  
Laminectomy punches and rongeurs  
Pinzas cortantes para laminectomía  
Pincés emporte-pièces à laminectomie et rongeurs  
Pinze taglienti per laminectomia e pinze per afferrare

23-34

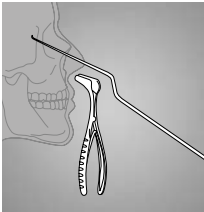

Hypophysen- und Schädelbasis-Chirurgie  
Pituitary und Schädelbasis surgery  
Cirugía para hipófisis und Schädelbasis  
Chirurgie de l'hypophyse und Schädelbasis  
Chirurgia per l'ipofisi und Schädelbasis

35-74

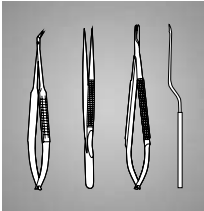

Mikro-Instrumente  
Micro instruments  
Micro-instrumentos  
Micro-instruments  
Micro-strumenti

37-44

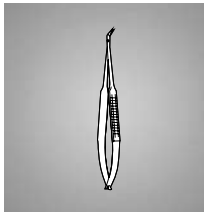

Mikro-Scheren  
Micro Scissors  
Micro-Tijeras  
Micro-Ciseaux  
Micro-Forbici

45-50

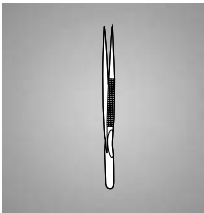

Mikro-Pinzetten  
Micro Forceps  
Micro-Pinzas  
Micro-Pincés  
Micro-Pinze

51-62

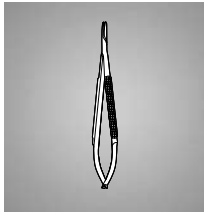

Mikro-Nadelhalter  
Micro Needle Holders  
Micro-Porta-agujas  
Micro-Porte-aiguilles  
Micro-Portaghi

63-74



Mikro-Instrumente  
Micro instruments  
Micro-instrumentos  
Micro-instruments  
Micro-strumenti

75-315



Allgemeines Instrumentarium  
General instruments  
Instrumentos generales  
Instrumentation générale  
Strumentario generale

77-82



Skalpelle  
Scalpels  
Bisturíes  
Bistouris  
Bisturi

83-134



Scheren  
Scissors  
Tijeras  
Ciseaux  
Forbici

135-148



Pinzetten  
Forceps  
Pinzas  
Pinces  
Pinze

149-166



Klemmen  
Forceps  
Pinzas  
Pinces  
Pinze

167-220

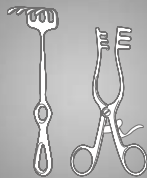

Wundhaken, Halte- und Spreizsysteme  
Retractors, Holding and spreading systems  
Separadores, Sistemas de sujeción y dispersión  
Ecarteurs, Systèmes de maintien et d'épandage  
Divaricatori, Sistemi di tenuta e diffusione

221-223

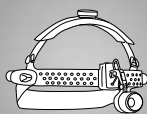

Diagnostik  
Diagnostics  
Diagnóstico  
Diagnostic  
Diagnostica

# Übersichtstafel

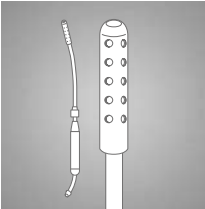
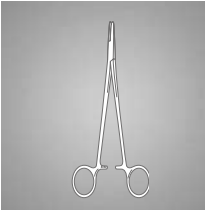
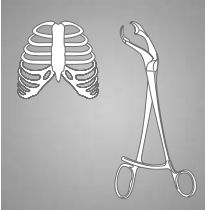

Table of Contents

Tabla de catálogo

Contenu

Indice di catalogo

---

|         |   |   |
|---------|---|---|
| 225-243 |    | Sauger, Kanülen<br>Suction Tubes, Cannulas<br>Tubos de Aspiración, Cánulas<br>Tubes d'aspiration, Canules<br>Tubi d'aspirazione, Cannule      |
| 245-251 |    | Naht<br>Suture<br>Sutura<br>Suture<br>Sutura  |
| 253-315 |   | Knochenchirurgie<br>Bone Surgery<br>Cirugía ósea<br>Chirurgie osseuse<br>Chirurgia ossea  |
| 317-325 |  | Verschiedenes<br>Miscellaneous<br>Diversos artículos<br>Articles divers<br>Articoli diversi   |
| 327-334 |  | Nummern-Index<br>Index of order numbers<br>Índice de números de referencia<br>Index numérique des références de commande<br>Elenco dei codici |

---



**Weitere Kataloge von KLS Martin**

Zu den folgenden Produktgruppen sind jeweils eigene Kataloge verfügbar, die Sie gerne bei uns anfordern können:

**Further catalogs of KLS Martin**

For the following product groups additional catalogs are available. Please ask for your personal copy:

**Más catálogos de KLS Martin**

Para los grupos siguientes tenemos catálogos individuales disponibles. No duden pedirnos más ejemplares:

**Autres catalogues de KLS Martin**

Pour les groupes de produits suivants sont disponibles des catalogues additionnels dont vous pouvez demander le nombre désiré:

**Altri cataloghi di KLS Martin**

Per i gruppi di prodotti seguenti sono disponibili cataloghi addizionali. La preghiamo di informarci se desidera altre copie:

Allgemeine Chirurgie  
General Surgery  
Cirugía general  
Chirurgie générale  
Chirurgia generale

Plastische Chirurgie  
Plastic Surgery  
Cirugía plástica  
Chirurgie plastique  
Chirurgia plastica

Herz-, Thorax- und Gefäßchirurgie  
Cardio, Thoracic and Vascular Surgery  
Cirugía cardíaca, torácica y vascular  
Chirurgie cardiaque, thoracique et vasculaire  
Chirurgia cardiaca, toracica e vascolare

Steriltechnik  
Sterile Technology  
Técnica de esterilización  
Technologie stérile  
Tecnica di sterilizzazione

Deckenversorgungseinheiten  
Ceiling-mounting systems  
Unidades de alimentación de techo  
Unités d'alimentation montées au plafond  
Sistemi pensili

OP-Leuchten  
Operating Theatre Lights  
Lámparas de quirófano  
Lampes opératoires  
Lampade scialitiche

Hochfrequenzchirurgie  
Electrosurgery  
Electrocirugía  
Électrochirurgicaux  
Elettrochirurgia

Mund-, Kiefer- und Gesichtschirurgie  
Oral and Craniomaxillofacial surgery  
Cirugía oral y maxilofacial  
Chirurgie orale et maxillofaciale  
Chirurgia orale e maxillofacciale



Laminektomiestanzen und Rongeurs  
Laminectomy punches and rongeurs  
Pinzas cortantes para laminectomía  
Pincés emporte-pièces à laminectomie et rongeurs  
Pinze taglienti per laminectomia e pinze per afferrare

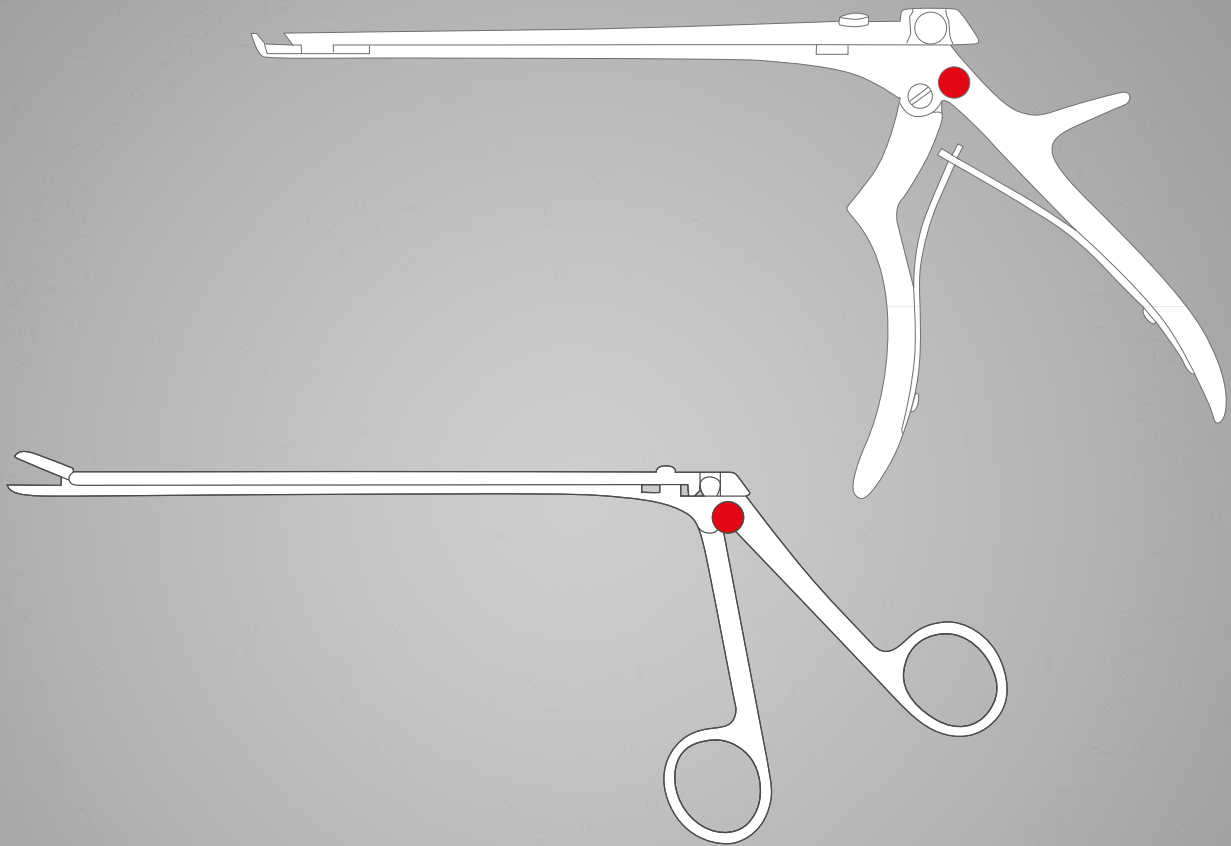

## Laminektomiestanzen

Laminectomy Punches

Pinzas cortantes para laminectomía

Pinces emporte-pièces à laminectomie

Pinze taglianti per laminectomia



### Ferris-Smith-Kerrison

24-978-01-07 -

24-978-48-14

Stanze mit Auswerfer, zerlegbar

Punch, with ejector, detachable

Perforador con eyector, desmontable

Perforateur avec éjecteur, démontable

Pinze taglianti con espulsore, smontabile

| Maulbreite<br>Jaw width<br>Anchura de la boca<br>Largeur de mors<br>Larghezza della bocca |   | 40°<br>aufwärts schneidend<br>cutting upward<br>corte arriba<br>tranchant vers le haut<br>tagliante verso l'alto |              |              |              | 90°<br>aufwärts schneidend<br>cutting upward<br>corte arriba<br>tranchant vers le haut<br>tagliante verso l'alto |              |              |              |              |
|---|---|--|--------------|--------------|--------------|--|--------------|--------------|--------------|--------------|
|   |   | L  | 18 cm        | 20 cm        | 23 cm        | 28 cm  | 18 cm        | 20 cm        | 23 cm        | 28 cm        |
| 1 mm  | ○ | St   | 24-978-01-07 | 24-978-03-07 | 24-978-05-07 | 24-978-07-07   | 24-978-02-07 | 24-978-04-07 | 24-978-06-07 | 24-978-08-07 |
|   |   | SB   | 24-978-01-14 | 24-978-03-14 | 24-978-05-14 | 24-978-07-14   | 24-978-02-14 | 24-978-04-14 | 24-978-06-14 | 24-978-08-14 |
| 2 mm  | ◐ | St   | 24-978-09-07 | 24-978-11-07 | 24-978-13-07 | 24-978-15-07   | 24-978-10-07 | 24-978-12-07 | 24-978-14-07 | 24-978-16-07 |
|   |   | SB   | 24-978-09-14 | 24-978-11-14 | 24-978-13-14 | 24-978-15-14   | 24-978-10-14 | 24-978-12-14 | 24-978-14-14 | 24-978-16-14 |
| 3 mm  | ◑ | St   | 24-978-17-07 | 24-978-19-07 | 24-978-21-07 | 24-978-23-07   | 24-978-18-07 | 24-978-20-07 | 24-978-22-07 | 24-978-24-07 |
|   |   | SB   | 24-978-17-14 | 24-978-19-14 | 24-978-21-14 | 24-978-23-14   | 24-978-18-14 | 24-978-20-14 | 24-978-22-14 | 24-978-24-14 |
| 4 mm  | ◒ | St   | 24-978-25-07 | 24-978-27-07 | 24-978-29-07 | 24-978-31-07   | 24-978-26-07 | 24-978-28-07 | 24-978-30-07 | 24-978-32-07 |
|   |   | SB   | 24-978-25-14 | 24-978-27-14 | 24-978-29-14 | 24-978-31-14   | 24-978-26-14 | 24-978-28-14 | 24-978-30-14 | 24-978-32-14 |
| 5 mm  | ◓ | St   | 24-978-33-07 | 24-978-35-07 | 24-978-37-07 | 24-978-39-07   | 24-978-34-07 | 24-978-36-07 | 24-978-38-07 | 24-978-40-07 |
|   |   | SB   | 24-978-33-14 | 24-978-35-14 | 24-978-37-14 | 24-978-39-14   | 24-978-34-14 | 24-978-36-14 | 24-978-38-14 | 24-978-40-14 |
| 6 mm  | ◔ | St   | 24-978-41-07 | 24-978-43-07 | 24-978-45-07 | 24-978-47-07   | 24-978-42-07 | 24-978-44-07 | 24-978-46-07 | 24-978-48-07 |
|   |   | SB   | 24-978-41-14 | 24-978-43-14 | 24-978-45-14 | 24-978-47-14   | 24-978-42-14 | 24-978-44-14 | 24-978-46-14 | 24-978-48-14 |

## Laminektomiestanzen

Laminectomy Punches

Pinzas cortantes para laminectomía

Pinces emporte-pièces à laminectomie

Pinze taglianti per laminectomia

## Laminektomiestanzen und Rongeurs

Laminectomy punches and rongeurs

Pinzas cortantes para laminectomía

Pinces emporte-pièces à laminectomie et rongeurs

Pinze taglianti per laminectomia e pinze per afferrare

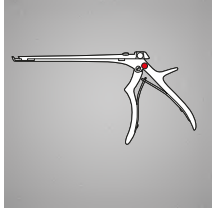

### Ferris-Smith-Kerrison

24-978-50-07 -

24-978-85-14

Stanze mit Auswerfer, zerlegbar

Punch, with ejector, detachable

Perforador con eyector, desmontable

Perforateur avec éjecteur, démontable

Pinze taglianti con espulsore, smontabile

| Maulbreite<br>Jaw width<br>Anchura de la boca<br>Largeur de mors<br>Larghezza della bocca | 40°<br>abwärts schneidend<br>cutting downward<br>desmontable, corte abajo<br>tranchant vers le bas<br>tagliante verso il basso |              |              | 90°<br>abwärts schneidend<br>cutting downward<br>desmontable, corte abajo<br>tranchant vers le bas<br>tagliante verso il basso |              |              |              |
|---|--|--------------|--------------|--|--------------|--------------|--------------|
|   | L  | 18 cm        | 20 cm        | 23 cm  | 18 cm        | 20 cm        | 23 cm        |
| 1 mm  | St   | 24-978-50-07 | 24-978-52-07 | 24-978-54-07   | 24-978-51-07 | 24-978-53-07 | 24-978-55-07 |
|   | SB   | 24-978-50-14 | 24-978-52-14 | 24-978-54-14   | 24-978-51-14 | 24-978-53-14 | 24-978-55-14 |
| 2 mm  | St   | 24-978-56-07 | 24-978-58-07 | 24-978-60-07   | 24-978-57-07 | 24-978-59-07 | 24-978-61-07 |
|   | SB   | 24-978-56-14 | 24-978-58-14 | 24-978-60-14   | 24-978-57-14 | 24-978-59-14 | 24-978-61-14 |
| 3 mm  | St   | 24-978-62-07 | 24-978-64-07 | 24-978-66-07   | 24-978-63-07 | 24-978-65-07 | 24-978-67-07 |
|   | SB   | 24-978-62-14 | 24-978-64-14 | 24-978-66-14   | 24-978-63-14 | 24-978-65-14 | 24-978-67-14 |
| 4 mm  | St   | 24-978-68-07 | 24-978-70-07 | 24-978-72-07   | 24-978-69-07 | 24-978-71-07 | 24-978-73-07 |
|   | SB   | 24-978-68-14 | 24-978-70-14 | 24-978-72-14   | 24-978-69-14 | 24-978-71-14 | 24-978-73-14 |
| 5 mm  | St   | 24-978-74-07 | 24-978-76-07 | 24-978-78-07   | 24-978-75-07 | 24-978-77-07 | 24-978-79-07 |
|   | SB   | 24-978-74-14 | 24-978-76-14 | 24-978-78-14   | 24-978-75-14 | 24-978-77-14 | 24-978-79-14 |
| 6 mm  | St   | 24-978-80-07 | 24-978-82-07 | 24-978-84-07   | 24-978-81-07 | 24-978-83-07 | 24-978-85-07 |
|   | SB   | 24-978-80-14 | 24-978-82-14 | 24-978-84-14   | 24-978-81-14 | 24-978-83-14 | 24-978-85-14 |

## Laminektomiestanzen

Laminectomy Punches

Pinzas cortantes para laminectomía

Pinces emporte-pièces à laminectomie

Pinze taglienti per laminectomia

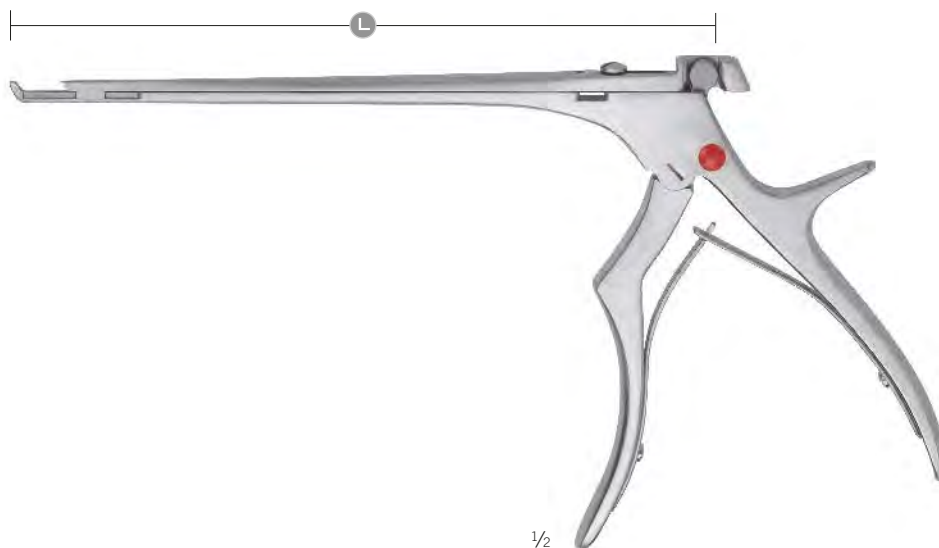

### Ferris-Smith-Kerrison

24-978-90-07 -

24-978-95-14







Stanze mit Auswerfer, zerlegbar, **Langhub**

Punch, with ejector, detachable, **long stroke**

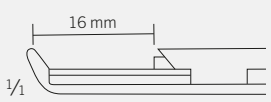
Perforador con eyector, desmontable, **carrera larga**

Perforateur avec éjecteur, démontable, **course longue**

Pinze taglienti con espulsore, smontabile, **corsa lunga**

| Maulbreite<br>Jaw width<br>Anchura de la boca<br>Largeur de mors<br>Larghezza della bocca | 40°<br>aufwärts schneidend<br>cutting upward<br>corte arriba<br>tranchant vers le haut<br>tagliente verso l'alto |  |
|---|--|--|
| 1 mm   | <b>L</b>   | <b>18 cm</b>   |
|   | <b>St</b>  | 24-978-90-07   |
| 2 mm   | <b>SB</b>  | 24-978-90-14   |
|   | <b>St</b>  | 24-978-91-07   |
| 3 mm   | <b>SB</b>  | 24-978-91-14   |
|   | <b>St</b>  | 24-978-92-07   |
| 4 mm   | <b>SB</b>  | 24-978-92-14   |
|   | <b>St</b>  | 24-978-93-07   |
| 5 mm   | <b>SB</b>  | 24-978-93-14   |
|   | <b>St</b>  | 24-978-94-07   |
| 6 mm   | <b>SB</b>  | 24-978-94-14   |
|   | <b>St</b>  | 24-978-95-07   |
|   | <b>SB</b>  | 24-978-95-14   |

## Laminectomiestanzen

Laminectomy Punches

Pinzas cortantes para laminectomía

Pinces emporte-pièces à laminectomie

Pinze taglianti per laminectomia

## Laminectomiestanzen und Rongeure

Laminectomy punches and rongeurs

Pinzas cortantes para laminectomía

Pinces emporte-pièces à laminectomie et rongeurs

Pinze taglianti per laminectomia e pinze per afferrare

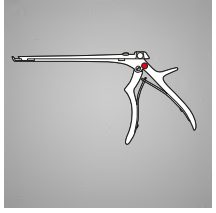

### Ferris-Smith-Kerrison

24-979-01-07 -

24-979-48-14

Stanze mit Auswerfer, zerlegbar, **dünne Platte**

Punch, with ejector, detachable, **thin plate**

Perforador con eyector, desmontable, **placa delgada**

Perforateur avec éjecteur, démontable, **plaque mince**

Pinze taglianti con espulsore, smontabile, **piastra sottile**

| Maulbreite<br>Jaw width<br>Anchura de la boca<br>Largeur de mors<br>Larghezza della bocca |   | 40°<br>aufwärts schneidend<br>cutting upward<br>corte arriba<br>tranchant vers le haut<br>tagliante verso l'alto |              |              |              | 90°<br>aufwärts schneidend<br>cutting upward<br>corte arriba<br>tranchant vers le haut<br>tagliante verso l'alto |              |              |              |              |
|---|---|--|--------------|--------------|--------------|--|--------------|--------------|--------------|--------------|
|   |   | L  | 18 cm        | 20 cm        | 23 cm        | 28 cm  | 18 cm        | 20 cm        | 23 cm        | 28 cm        |
| 1 mm  | ○ | St   | 24-979-01-07 | 24-979-03-07 | 24-979-05-07 | 24-979-07-07   | 24-979-02-07 | 24-979-04-07 | 24-979-06-07 | 24-979-08-07 |
|   |   | SB   | 24-979-01-14 | 24-979-03-14 | 24-979-05-14 | 24-979-07-14   | 24-979-02-14 | 24-979-04-14 | 24-979-06-14 | 24-979-08-14 |
| 2 mm  | ◐ | St   | 24-979-09-07 | 24-979-11-07 | 24-979-13-07 | 24-979-15-07   | 24-979-10-07 | 24-979-12-07 | 24-979-14-07 | 24-979-16-07 |
|   |   | SB   | 24-979-09-14 | 24-979-11-14 | 24-979-13-14 | 24-979-15-14   | 24-979-10-14 | 24-979-12-14 | 24-979-14-14 | 24-979-16-14 |
| 3 mm  | ◑ | St   | 24-979-17-07 | 24-979-19-07 | 24-979-21-07 | 24-979-23-07   | 24-979-18-07 | 24-979-20-07 | 24-979-22-07 | 24-979-24-07 |
|   |   | SB   | 24-979-17-14 | 24-979-19-14 | 24-979-21-14 | 24-979-23-14   | 24-979-18-14 | 24-979-20-14 | 24-979-22-14 | 24-979-24-14 |
| 4 mm  | ◒ | St   | 24-979-25-07 | 24-979-27-07 | 24-979-29-07 | 24-979-31-07   | 24-979-26-07 | 24-979-28-07 | 24-979-30-07 | 24-979-32-07 |
|   |   | SB   | 24-979-25-14 | 24-979-27-14 | 24-979-29-14 | 24-979-31-14   | 24-979-26-14 | 24-979-28-14 | 24-979-30-14 | 24-979-32-14 |
| 5 mm  | ◓ | St   | 24-979-33-07 | 24-979-35-07 | 24-979-37-07 | 24-979-39-07   | 24-979-34-07 | 24-979-36-07 | 24-979-38-07 | 24-979-40-07 |
|   |   | SB   | 24-979-33-14 | 24-979-35-14 | 24-979-37-14 | 24-979-39-14   | 24-979-34-14 | 24-979-36-14 | 24-979-38-14 | 24-979-40-14 |
| 6 mm  | ◔ | St   | 24-979-41-07 | 24-979-43-07 | 24-979-45-07 | 24-979-47-07   | 24-979-42-07 | 24-979-44-07 | 24-979-46-07 | 24-979-48-07 |
|   |   | SB   | 24-979-41-14 | 24-979-43-14 | 24-979-45-14 | 24-979-47-14   | 24-979-42-14 | 24-979-44-14 | 24-979-46-14 | 24-979-48-14 |

## Laminektomiestanzen

Laminectomy Punches

Pinzas cortantes para laminectomía

Pinces emporte-pièces à laminectomie

Pinze taglienti per laminectomia

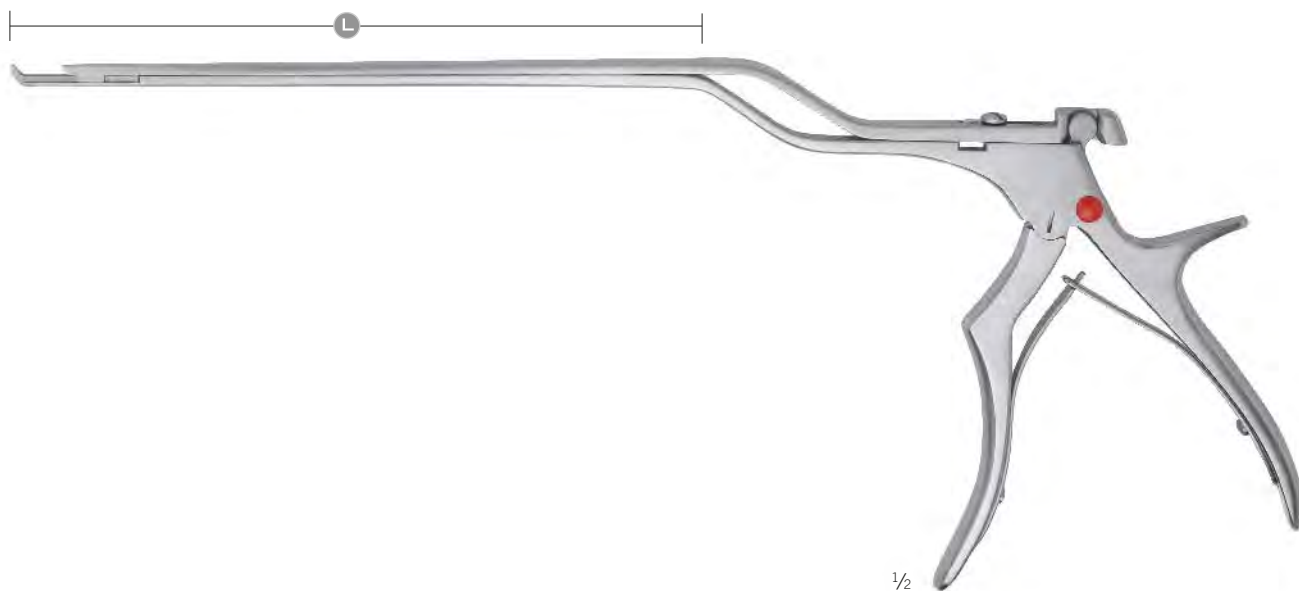

Ferris-Smith-Kerrison

24-980-21-07 -

24-980-25-14







Stanze mit Auswerfer, zerlegbar, **Langhub**

Punch, with ejector, detachable, **long stroke**

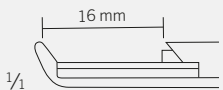
Perforador con eyector, desmontable, **carrera larga**

Perforateur avec éjecteur, démontable, **course longue**

Pinze taglienti con espulsore, smontabile, **corsa lunga**

| Maulbreite<br>Jaw width<br>Anchura de la boca<br>Largeur de mors<br>Larghezza della bocca |   | 40°<br>aufwärts schneidend, bajonett<br>cutting upward, bayonet<br>corte arriba, bayoneta<br>tranchant vers le haut, baïonnette<br>tagliente verso l'alto, baionetta |  |
|---|---|--|---|
|   | <b>L</b>  | <b>18 cm</b>   |   |
| 1 mm  |  | <b>St</b>  | 24-980-21-07  |
|   |   | <b>SB</b>  | 24-980-21-14  |
| 2 mm  |  | <b>St</b>  | 24-980-22-07  |
|   |   | <b>SB</b>  | 24-980-22-14  |
| 3 mm  |  | <b>St</b>  | 24-980-23-07  |
|   |   | <b>SB</b>  | 24-980-23-14  |
| 4 mm  |  | <b>St</b>  | 24-980-24-07  |
|   |   | <b>SB</b>  | 24-980-24-14  |
| 5 mm  |  | <b>St</b>  | 24-980-25-07  |
|   |   | <b>SB</b>  | 24-980-25-14  |



## Laminektomiestanzen

Laminectomy Punches

Pinzas cortantes para laminectomía

Pinces emporte-pièces à laminectomie

Pinze taglianti per laminectomia

## Laminektomiestanzen und Rongeurs

Laminectomy punches and rongeurs

Pinzas cortantes para laminectomía

Pinces emporte-pièces à laminectomie et rongeurs

Pinze taglianti per laminectomia e pinze per afferrare

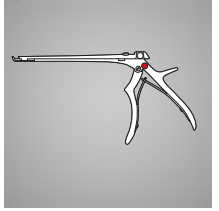

Ferris-Smith-Kerrison

24-980-30-07 -

24-980-44-14











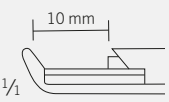
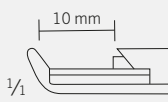
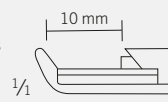























Stanze mit Auswerfer, zerlegbar

Punch, with ejector, detachable

Perforador con eyector, desmontable

Perforateur avec éjecteur, démontable

Pinze taglianti con espulsore, smontabile

| Maulbreite<br>Jaw width<br>Anchura de la boca<br>Largeur de mors<br>Larghezza della bocca |   | 40°<br>aufwärts gebogen<br>curved upward<br>curvo arriba<br>coudé vers le haut<br>curva verso l'alto |  | 40°<br>links gebogen<br>curved leftwards<br>curvo izquierda<br>coudé à gauche<br>curva a sinistra |  | 40°<br>rechts gebogen<br>curved rightwards<br>curvo derecha<br>coudé à droite<br>curva a destra    |  |
|---|---|--|--|---|--|--|--|
|   |   |                   |              |              |               |                |               |
|   | <b>L</b>  | <b>20 cm</b>   |  | <b>20 cm</b>  |  | <b>20 cm</b>   |  |
| 1 mm  |  |  24-980-30-07     |  24-980-30-14 |  24-980-31-07  |  24-980-31-14 |  24-980-32-07 |  24-980-32-14 |
|   | 2 mm  |                   |  24-980-33-07 |  24-980-33-14  |  24-980-34-07 |  24-980-34-14   |  24-980-35-07 |
| 3 mm  |   |                   |  24-980-36-07 |  24-980-36-14  |  24-980-37-07 |  24-980-37-14   |  24-980-38-07 |
|   | 4 mm  |                   |  24-980-39-07 |  24-980-39-14  |  24-980-40-07 |  24-980-40-14   |  24-980-41-07 |
| 5 mm  |   |                   |  24-980-42-07 |  24-980-42-14  |  24-980-43-07 |  24-980-43-14   |  24-980-44-07 |

## Laminektomiestanzen

Laminectomy Punches

Pinzas cortantes para laminectomía

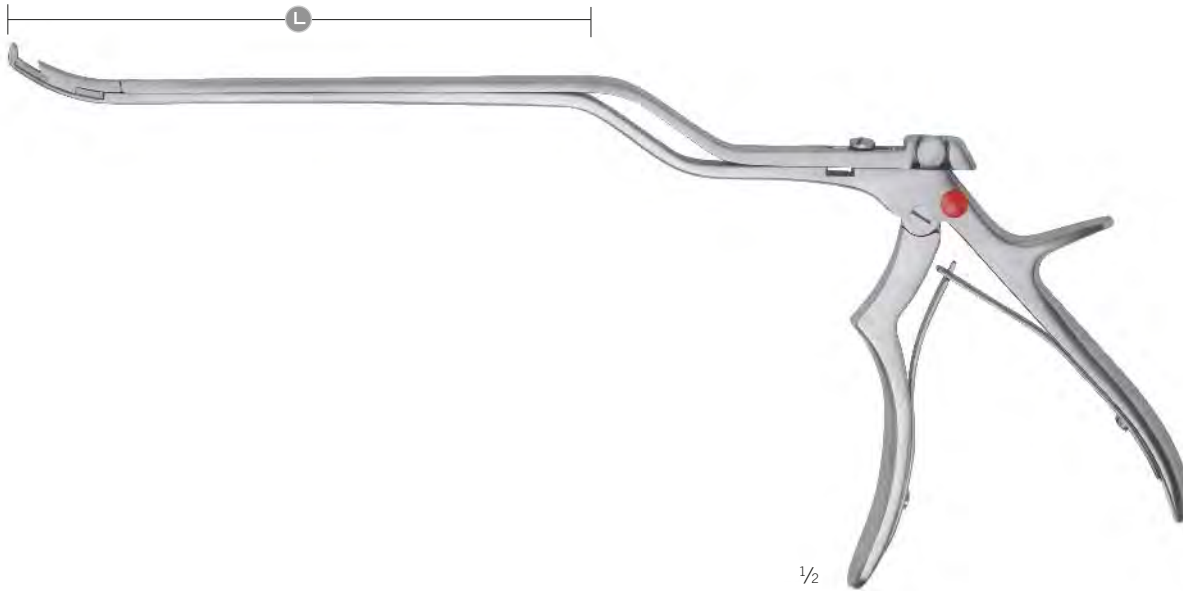

Pinces emporte-pièces à laminectomie

Pinze taglienti per laminectomia

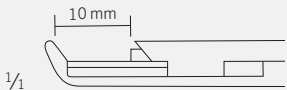

Ferris-Smith-Kerrison  
24-980-50-07

Stanze mit Auswerfer, zerlegbar  
Punch, with ejector, detachable  
Perforador con eyector, desmontable  
Perforateur avec éjecteur, démontable  
Pinze taglienti con espulsore, smontabile

|  |   |  |
|--|---|--|
| <b>Maulbreite</b><br><b>Jaw width</b><br><b>Anchura de la boca</b><br><b>Largeur de mors</b><br><b>Larghezza della bocca</b> | <b>40°</b><br><b>gebogen, bajonett</b><br><b>curved, bayonet</b><br><b>curvo, bayoneta</b><br><b>coudé, baïonnette</b><br><b>curva, baionetta</b> |  |
| <b>3 mm</b>                               | <b>L</b> <b>15 cm</b>   |  |
|  | <b>St</b> <b>24-980-50-07</b>   |  |

## Zerlegen der Instrumente

Instrument disassembly  
Desmontaje de los instrumentos  
Démontage des instruments  
Smontaggio degli strumenti

## Laminectomiestanzen und Rongeurs

Laminectomy punches and rongeurs  
Pinzas cortantes para laminectomía  
Pincas emporte-pièces à laminectomie et rongeurs  
Pinze taglianti per laminectomia e pinze per afferrare

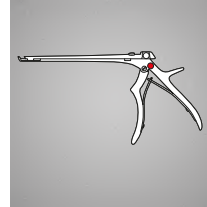

### Anweisung zum Öffnen

1. Griff schließen.
2. Knopf drücken und gedrückt halten.
3. Griff wieder öffnen. Druck auf roten Knopf beibehalten.
4. Das obere Schieberteil ist entriegelt und kann nach links ausgeschwenkt werden.



### Disassembly Instructions

1. Close the handle.
2. Push the button and keep it pushed.
3. Release quickly the front part of the handle.
4. The upper movable shaft is unlocked and can be slid to the left.



### Instrucciones de apertura

1. Cerrar el mango.
2. Presionar el botón y mantenerlo pulsado.
3. Volver a abrir el mango.
4. El vástago superior corredero desengrana y puede girarse hacia la izquierda.



### Consigne d'ouverture

1. Refermez le manche.
2. Appuyez sur le bouton et maintenez-le enfoncé.
3. Rouvrez le manche.
4. La partie supérieure du curseur est débloquée et peut être pivotée vers la gauche.



### Istruzioni per l'apertura

1. Chiudere l'impugnatura.
2. Premere e tenere premuto il pulsante.
3. Riaprire l'impugnatura.
4. La parte superiore scorrevole si sblocca e può essere ruotata a sinistra.

### Hinweis

Durch nochmaliges Schließen des Griffes bleibt der Schaft ausgeschwenkt und das Instrument kann in offenem Zustand sterilisiert werden.

### Advice

If the handle is closed again, the shaft remains swivelled out so that the instrument can be sterilized in open position.

### Nota

Al volver a cerrar el mango de forma normal, el vástago gira y el instrumento puede esterilizarse abierto.

### Remarque

En refermant une nouvelle fois le manche, la tige pivotée reste en position et l'instrument ainsi ouvert peut être stérilisé.

### Nota

Richiudendo l'impugnatura il gambo resta ruotato, in modo da consentire la sterilizzazione dello strumento aperto.

### Zusammensetzen

1. Griff schließen.
2. Knopf drücken und gedrückt halten.
3. Griff öffnen, Schieber einschwenken und nach unten drücken.
4. Griff nochmals schließen – das Instrument ist verriegelt.

### Assembly Instructions

1. Close the handle.
2. Push the button and keep it pushed.
3. Open the handle. Slide back the movable shaft on the instrument and push the shaft downward.
4. Close the handle once again and the instrument is locked.

### Montaje

1. Cerrar el mango.
2. Presionar el botón y mantenerlo pulsado.
3. Abrir el mango, girar el vástago hacia el instrumento y presionar hacia abajo.
4. Volver a cerrar el mango. El instrumento está bloqueado de nuevo.

### Assemblage

1. Fermez le manche.
2. Appuyez sur le bouton et maintenez-le enfoncé.
3. Ouvrez le manche, faites pivoter le curseur et appuyez vers le bas.
4. Rouvrez le manche - l'instrument est verrouillé.

### Rimontaggio

1. Chiudere l'impugnatura.
2. Premere e tenere premuto il pulsante.
3. Aprire l'impugnatura, ritrarre la barra scorrevole e premere verso il basso.
4. Richiudere l'impugnatura – lo strumento è bloccato.



### LubriPen 55-997-01-04

für präzises Ölen von chirurgischen Instrumenten und Medizinprodukten  
for precise lubrication of surgical instruments and medical devices  
para una lubricación perfecta de instrumentos quirúrgicos y dispositivos médicos  
Graissage précis d'instruments chirurgicaux et d'équipements médicaux  
Lubrificazione di precisione di strumenti chirurgici e dispositivi medici



Zerlegen der Instrumente  
Instrument disassembly  
Desmontaje de los instrumentos  
Démontage des instruments  
Smontaggio degli strumenti

<https://www.youtube.com/watch?v=90fxTTgmBXw>

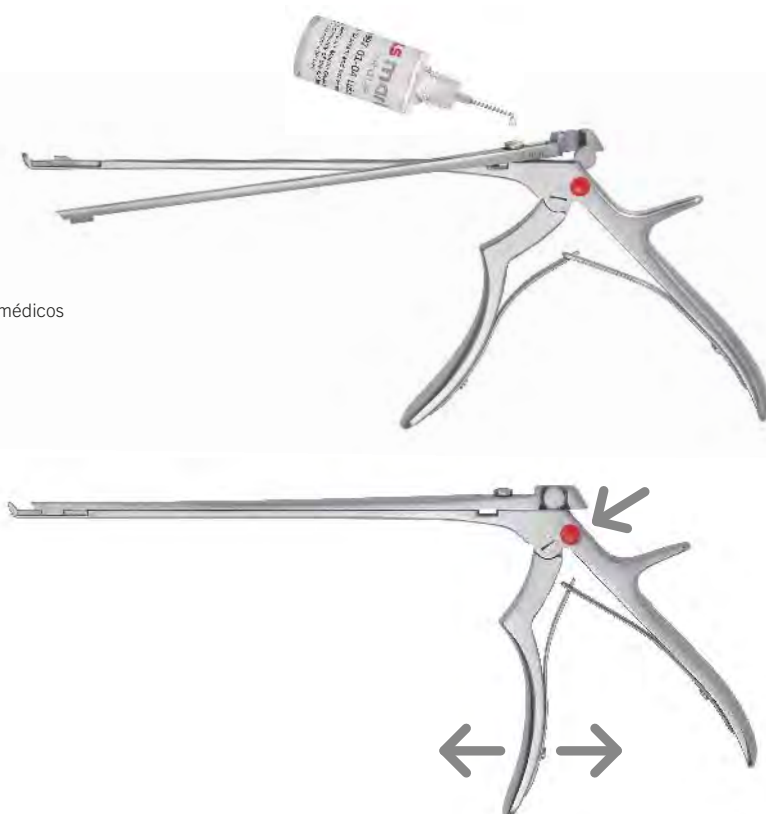

<https://www.youtube.com/watch?v=E8puyjo0MVk>

## Lagerung Laminektomiestanzen

Storage Laminectomy Punches

Almacenaje para pinzas cortantes para laminectomía

Rangement pour pinces emporte-pièces à laminectomie

Supporto per pinze taglianti per laminectomia



55-803-10-04

480 x 255 x 103 mm

Siebkorb zur Lagerung von Laminektomiestanzen

Mesh tray for storage of laminectomy punches

Bandeja cribada para almacenaje para pinzas cortantes para laminectomía

Panier à maille pour rangement pour pinces emporte-pièces à laminectomie

Vassoi reticolati per supporto per pinze taglianti per laminectomia



Beispiel Bestückung

Configuration example

Ejemplo de equipamiento

Exemple d'agencement

Esempio di strumenti

## Lagerung Laminektomiestanzen

Storage Laminectomy Punches

Almacenaje para pinzas cortantes para laminectomía

Rangement pour pinces emporte-pièces à laminectomie

Supporto per pinze taglienti per laminectomia

## Laminektomiestanzen und Rongeurs

Laminectomy punches and rongeurs

Pinzas cortantes para laminectomía

Pinces emporte-pièces à laminectomie et rongeurs

Pinze taglienti per laminectomia e pinze per afferrare

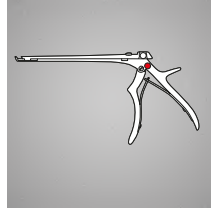

55-803-15-04

535 x 255 x 103 mm

Höhenreduzierter Siebkorb zur Lagerung von 4 Stanzen in besonders niedrigen Lagerungswägen für RDG (Reinigungs- und Desinfektionsgerät)

Lower mesh tray for storing 4 punches in very low mobile units for washer-disinfectors

Bandeja cribada de altura reducida para el almacenaje de 4 perforadores en carros de almacenaje especialmente bajos para máquinas de lavado y desinfección

Panier à mailles à hauteur réduite pour le rangement de 4 poinçons dans des chariots très bas pour laveur-désinfecteur

Vassoio reticolato ad altezza ridotta per il magazzino di 4 pinze taglienti in carrelli di carico particolarmente bassi per apparecchio di pulizia e disinfezione



Beispiel Bestückung

Configuration example

Ejemplo de equipamiento

Exemple d'agencement

Esempio di strumenti



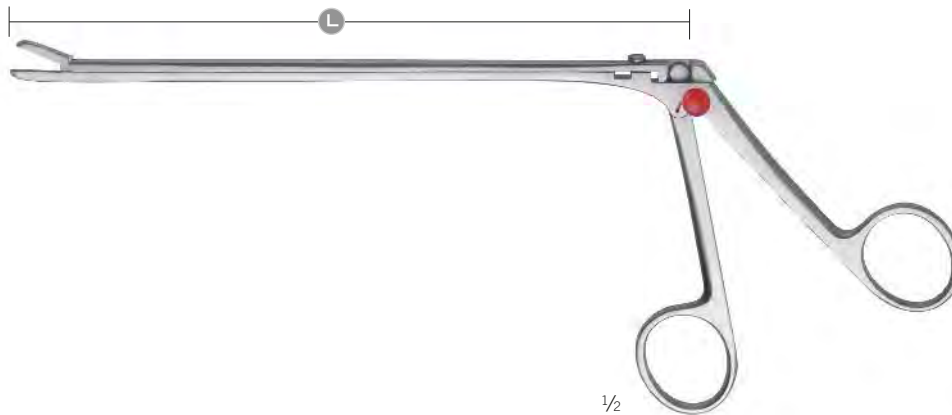

## Rongeur

Rongeurs  
Pinzas cortantes  
Rongeurs  
Pinze per afferrare



Caspar  
24-981-05-07 -  
24-981-16-14

zerlegbar  
detachable  
desmontable  
démontable  
smontabile

| Maulbreite<br>Jaw width<br>Anchura de la boca<br>Largeur de mors<br>Larghezza della bocca |    | gerade<br>straight<br>recto<br>droit<br>diritto |              |              |
|---|----|---|--------------|--------------|
|   |    | L   | 15 cm        | 18 cm        |
| 2 mm   | St | 24-981-05-07                                    | 24-981-09-07 | 24-981-13-07 |
|   | SB | 24-981-05-14                                    | 24-981-09-14 | 24-981-13-14 |
| 3 mm   | St | 24-981-06-07                                    | 24-981-10-07 | 24-981-14-07 |
|   | SB | 24-981-06-14                                    | 24-981-10-14 | 24-981-14-14 |
| 4 mm   | St | 24-981-07-07                                    | 24-981-11-07 | 24-981-15-07 |
|   | SB | 24-981-07-14                                    | 24-981-11-14 | 24-981-15-14 |
| 5 mm   | St | 24-981-08-07                                    | 24-981-12-07 | 24-981-16-07 |
|   | SB | 24-981-08-14                                    | 24-981-12-14 | 24-981-16-14 |

## Rongeurs

Rongeurs  
Pinzas cortantes  
Rongeurs  
Pinze per afferrare



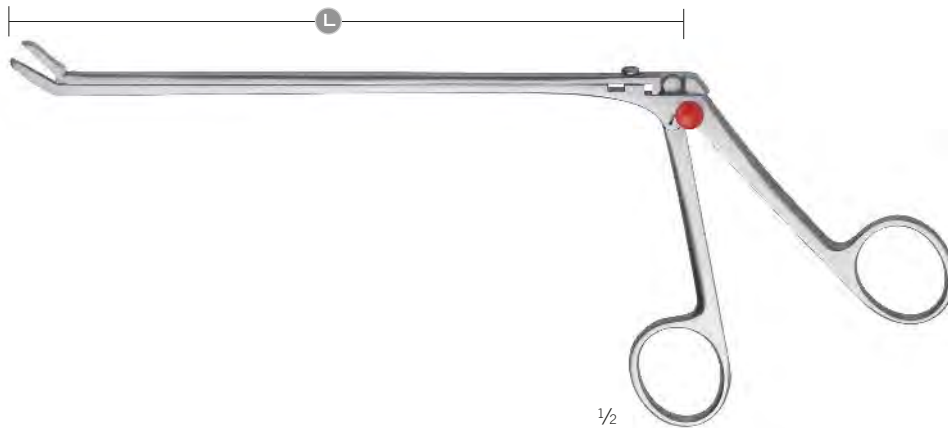
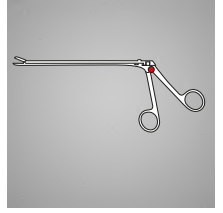

## Laminektomiestanzen und Rongeurs

Laminectomy punches and rongeurs  
Pinzas cortantes para laminectomía  
Pincas emporte-pièces à laminectomie et rongeurs  
Pinze taglianti per laminectomia e pinze per afferrare



Caspar  
24-981-25-07 -  
24-981-36-14

zerlegbar  
detachable  
desmontable  
démontable  
smontabile

| Maulbreite<br>Jaw width<br>Anchura de la boca<br>Largeur de mors<br>Larghezza della bocca |   | 30°<br>aufgewinkelt<br>angled upward<br>acodado arrib<br>angulé vers le haut<br>angolato verso l'alto |              |              |              |
|---|---|---|--------------|--------------|--------------|
|   |   | L   | 15 cm        | 18 cm        | 20 cm        |
| 2 mm  |  | St  | 24-981-25-07 | 24-981-29-07 | 24-981-33-07 |
|   |   | SB  | 24-981-25-14 | 24-981-29-14 | 24-981-33-14 |
| 3 mm  |  | St  | 24-981-26-07 | 24-981-30-07 | 24-981-34-07 |
|   |   | SB  | 24-981-26-14 | 24-981-30-14 | 24-981-34-14 |
| 4 mm  |  | St  | 24-981-27-07 | 24-981-31-07 | 24-981-35-07 |
|   |   | SB  | 24-981-27-14 | 24-981-31-14 | 24-981-35-14 |
| 5 mm  |  | St  | 24-981-28-07 | 24-981-32-07 | 24-981-36-07 |
|   |   | SB  | 24-981-28-14 | 24-981-32-14 | 24-981-36-14 |

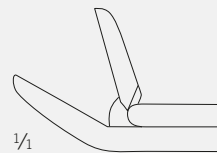



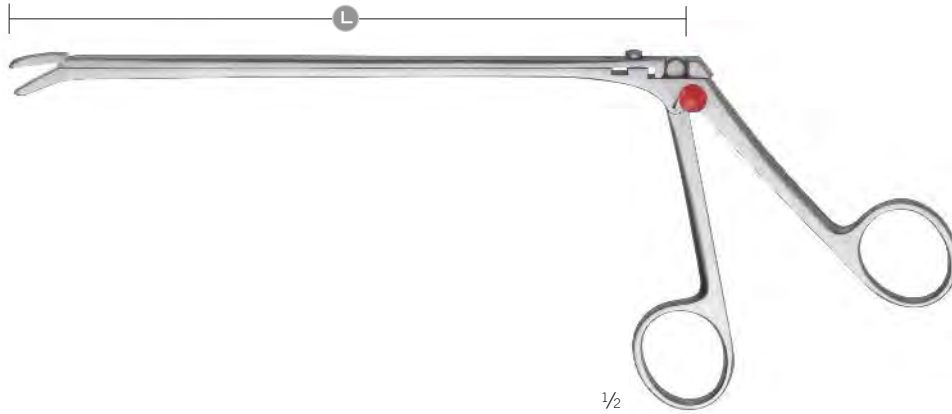

# Rongeur

Rongeurs  
Pinzas cortantes  
Rongeurs  
Pinze per afferrare



Caspar  
24-981-45-07 -  
24-981-56-14

zerlegbar  
detachable  
desmontable  
démontable  
smontabile

| Maulbreite<br>Jaw width<br>Anchura de la boca<br>Largeur de mors<br>Larghezza della bocca |   | 30°<br>abgewinkelt<br>angled downward<br>acodado abajo<br>angulé vers le bas<br>angolato verso il basso |              |              |              |
|---|---|---|--------------|--------------|--------------|
|   |   | L   | 15 cm        | 18 cm        | 20 cm        |
| 2 mm  |  | St  | 24-981-45-07 | 24-981-49-07 | 24-981-53-07 |
|   |   | SB  | 24-981-45-14 | 24-981-49-14 | 24-981-53-14 |
| 3 mm  |  | St  | 24-981-46-07 | 24-981-50-07 | 24-981-54-07 |
|   |   | SB  | 24-981-46-14 | 24-981-50-14 | 24-981-54-14 |
| 4 mm  |  | St  | 24-981-47-07 | 24-981-51-07 | 24-981-55-07 |
|   |   | SB  | 24-981-47-14 | 24-981-51-14 | 24-981-55-14 |
| 5 mm  |  | St  | 24-981-48-07 | 24-981-52-07 | 24-981-56-07 |
|   |   | SB  | 24-981-48-14 | 24-981-52-14 | 24-981-56-14 |

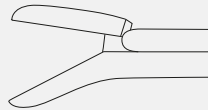



## Rongeurs

Rongeurs  
Pinzas cortantes  
Rongeurs  
Pinze per afferrare



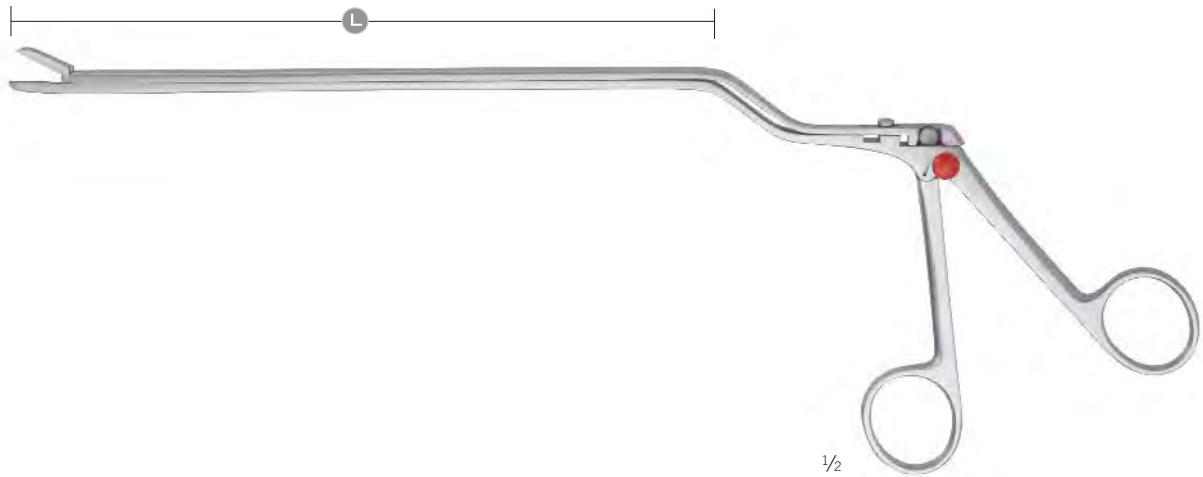
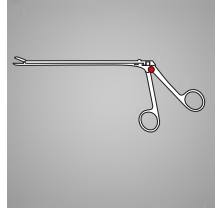

## Laminektomiestanzen und Rongeurs

Laminectomy punches and rongeurs  
Pinzas cortantes para laminectomía  
Pincas emporte-pièces à laminectomie et rongeurs  
Pinze taglianti per laminectomia e pinze per afferrare

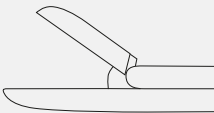

Caspar  
24-981-65-07 -  
24-981-68-14

zerlegbar  
detachable  
desmontable  
démontable  
smontabile

| Maulbreite<br>Jaw width<br>Anchura de la boca<br>Largeur de mors<br>Larghezza della bocca |   | gerade, bajonett<br>straight, bayonet<br>recto, bayoneta<br>droit, baïonnette<br>diritto, baionetta |  |
|---|---|---|--|
|   |   | <b>L</b>  | <b>18 cm</b>   |
| 2 mm  |  | <b>St</b>   | 24-981-65-07   |
|   |   | <b>SB</b>   | 24-981-65-14   |
| 3 mm  |  | <b>St</b>   | 24-981-66-07   |
|   |   | <b>SB</b>   | 24-981-66-14   |
| 4 mm  |  | <b>St</b>   | 24-981-67-07   |
|   |   | <b>SB</b>   | 24-981-67-14   |
| 5 mm  |  | <b>St</b>   | 24-981-68-07   |
|   |   | <b>SB</b>   | 24-981-68-14   |



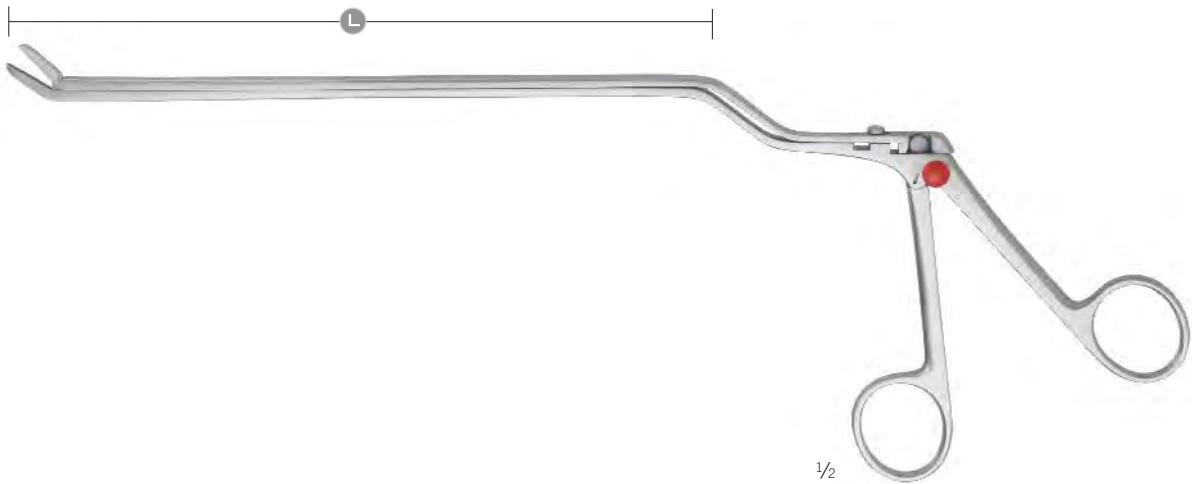

## Rongeur

Rongeurs  
Pinzas cortantes  
Rongeurs  
Pinze per afferrare

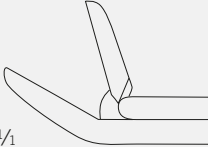

Caspar  
24-981-75-07 -  
24-981-78-14

zerlegbar  
detachable  
desmontable  
démontable  
smontabile

| Maulbreite<br>Jaw width<br>Anchura de la boca<br>Largeur de mors<br>Larghezza della bocca |   | 30°<br>aufgewinkelt, bajonett<br>angled upward, bayonet<br>acodado arriba, bayoneta<br>angulé vers le haut, baïonnette<br>angolato verso l'alto, baionetta |  |
|---|---|--|--|
|   |   | <b>L</b>   | <b>18 cm</b>   |
| 2 mm  |  | <b>St</b>  | 24-981-75-07   |
|   |   | <b>SB</b>  | 24-981-75-14   |
| 3 mm  |  | <b>St</b>  | 24-981-76-07   |
|   |   | <b>SB</b>  | 24-981-76-14   |
| 4 mm  |  | <b>St</b>  | 24-981-77-07   |
|   |   | <b>SB</b>  | 24-981-77-14   |
| 5 mm  |  | <b>St</b>  | 24-981-78-07   |
|   |   | <b>SB</b>  | 24-981-78-14   |

## Rongeurs

Rongeurs  
Pinzas cortantes  
Rongeurs  
Pinze per afferrare

## Laminektomiestanzen und Rongeurs

Laminectomy punches and rongeurs  
Pinzas cortantes para laminectomía  
Pinces emporte-pièces à laminectomie et rongeurs  
Pinze taglianti per laminectomia e pinze per afferrare

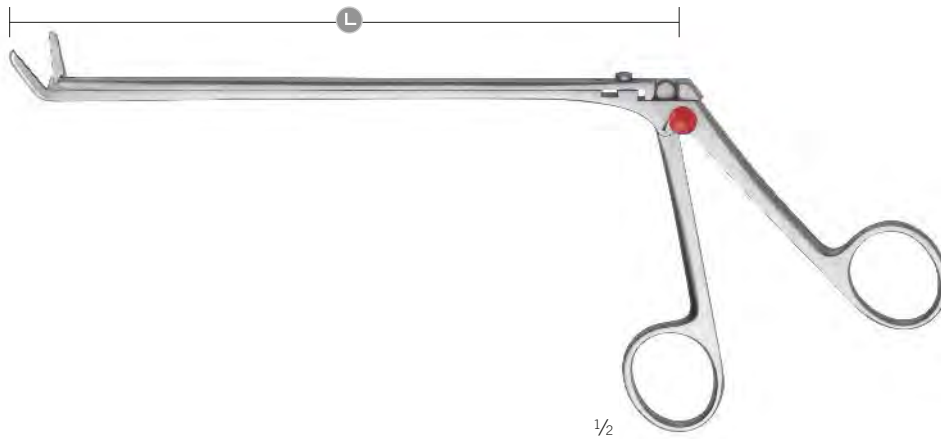
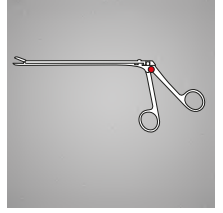

Caspar  
24-981-80-07 -  
24-981-83-14

zerlegbar  
detachable  
desmontable  
démontable  
smontabile

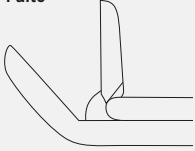
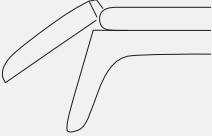

| Maulbreite<br>Jaw width<br>Anchura de la boca<br>Largeur de mors<br>Larghezza della bocca | 50°<br>aufgewinkelt<br>angled upward<br>acodado arrib<br>angulé vers le haut<br>angolato verso l'alto |   | 50°<br>abgewinkelt<br>angled downward<br>acodado abajo<br>angulé vers le bas<br>angolato verso il basso |   |              |
|---|---|---|---|---|--------------|
|   | 4 mm               |  |   |  |              |
| $\frac{1}{2}$   |   |   |   |   |              |
|   | <b>L</b>  | <b>18 cm</b>  | <b>30 cm</b>  | <b>18 cm</b>  | <b>30 cm</b> |
|   | <b>St</b>   | 24-981-80-07  | 24-981-81-07  | 24-981-82-07  | 24-981-83-07 |
|   | <b>SB</b>   | 24-981-80-14  | 24-981-81-14  | 24-981-82-14  | 24-981-83-14 |

# Rongeur

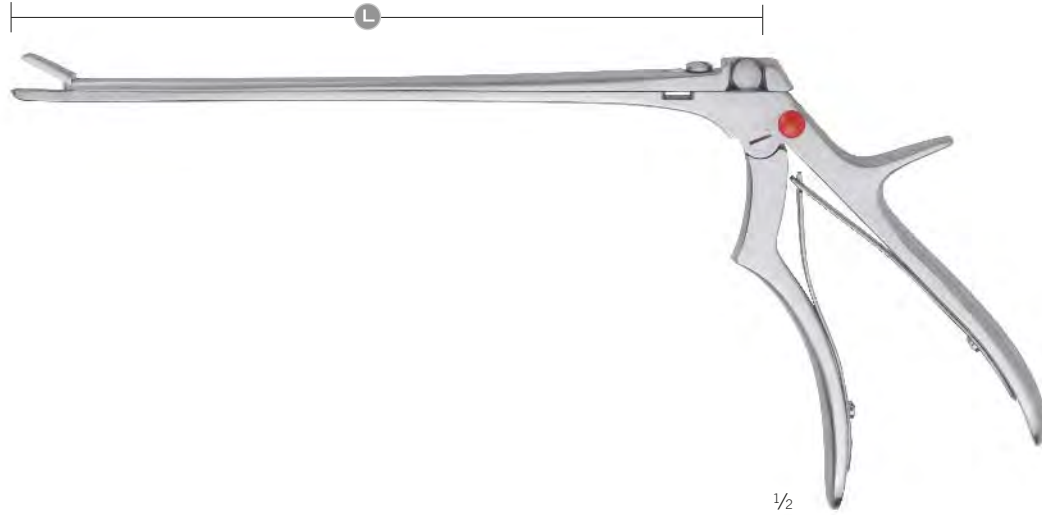
Rongeurs  
Pinzas cortantes  
Rongeurs  
Pinze per afferrare



Wagner  
24-981-91-07 -  
24-981-93-14  
zerlegbar, **kräftig**  
detachable, **strong model**  
desmontable, **robusto**  
démontable, **robuste**  
smontabile, **robusto**

| Maulbreite<br>Jaw width<br>Anchura de la boca<br>Largeur de mors<br>Larghezza della bocca |           | gerade<br>straight<br>recto<br>droit<br>diritto | 50°<br>aufgewinkelt<br>angled upward<br>acodado arrib<br>angulé vers le haut<br>angolato verso l'alto |              | 50°<br>abgewinkelt<br>angled downward<br>acodado abajo<br>angulé vers le bas<br>angolato verso il basso |              |
|---|-----------|---|---|--------------|---|--------------|
|   |           | $\frac{1}{1}$                                   | 20 cm   | 30 cm        | 20 cm   | 30 cm        |
| 3 mm   | <b>L</b>  | 20 cm   |   |              |   |              |
|   | <b>st</b> | 24-981-91-07                                    |   |              |   |              |
|   | <b>SB</b> | 24-981-91-14                                    |   |              |   |              |
| 4 mm   | <b>st</b> | 24-981-92-07                                    | 24-981-84-07  | 24-981-85-07 | 24-981-86-07  | 24-981-87-07 |
|   | <b>SB</b> | 24-981-92-14                                    | 24-981-84-14  | 24-981-85-14 | 24-981-86-14  | 24-981-87-14 |
| 5 mm   | <b>st</b> | 24-981-93-07                                    |   |              |   |              |
|   | <b>SB</b> | 24-981-93-14                                    |   |              |   |              |

## Rongeurs

Rongeurs  
Pinzas cortantes  
Rongeurs  
Pinze per afferrare



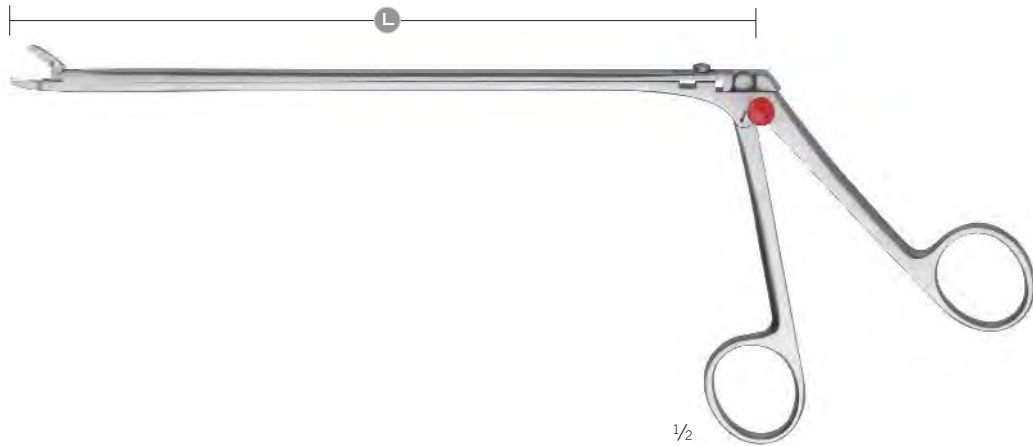
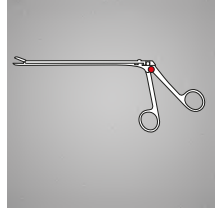

## Laminectomiestanzen und Rongeurs

Laminectomy punches and rongeurs  
Pinzas cortantes para laminectomía  
Pinces emporte-pièces à laminectomie et rongeurs  
Pinze taglianti per laminectomia e pinze per afferrare

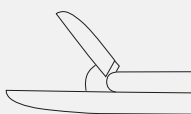

Richter  
24-982-10-07 -  
24-982-13-14

zerlegbar  
detachable  
desmontable  
démontable  
smontabile

| Maulbreite<br>Jaw width<br>Anchura de la boca<br>Largeur de mors<br>Larghezza della bocca  | gerade<br>straight<br>recto<br>droit<br>diritto |   | 30°<br>aufgewinkelt<br>angled upward<br>acodado arrib<br>angulé vers le haut<br>angolato verso l'alto |  |
|--|---|---|---|--|
|  | $\frac{1}{2}$                                   |  |                   |  |
| 1,0 mm  | <b>L</b>  | <b>18 cm</b>  | <b>18 cm</b>  |  |
|  | <b>St</b>                                       | 24-982-10-07  | 24-982-11-07  |  |
|  | <b>SB</b>                                       | 24-982-10-14  | 24-982-11-14  |  |
| 1,5 mm  | <b>St</b>                                       | 24-982-12-07  | 24-982-13-07  |  |
|  | <b>SB</b>                                       | 24-982-12-14  | 24-982-13-14  |  |

## Lagerung Rongeure

Storage Rongeurs

Almacenaje para pinzas cortantes

Rangement pour rongeurs

Supporto per pinze per afferrare



55-803-20-04

Siebkorb zur Lagerung von Rongeuren mit Ringgriffen

Mesh tray for storage of rongeurs mit Ringgriffen

Bandeja cribada para almacenaje para pinzas cortantes con anillos

Panier à maille pour rangement pour rongeurs avec poignées annulaires

Vassoi reticolati per supporto er pinze per afferrare con maniglie ad anello

Wagner-Rongeure werden in den Siebkörben der Stanzen gelagert

Wagner rongeurs are stored in the wire mesh trays of the punches

Las pinzas cortantes Wagner se almacenan en las bandejas cribadas de los punzones

Les rongeurs de Wagner sont conservés dans les paniers des poinçons

Le pinze per afferrare Wagner vengono conservate nei vassoi reticolati delle pinze



Beispiel Bestückung

Configuration example

Ejemplo de equipamiento

Exemple d'agencement

Esempio di strumenti

## Zerlegen der Instrumente

Instrument disassembly  
Desmontaje de los instrumentos  
Démontage des instruments  
Smontaggio degli strumenti

## Laminectomiestanzen und Rongeurs

Laminectomy punches and rongeurs  
Pinzas cortantes para laminectomía  
Pincas emporte-pièces à laminectomie et rongeurs  
Pinze taglianti per laminectomia e pinze per afferrare

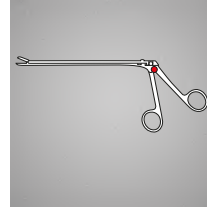

### Anweisung zum Öffnen

1. Griff schließen.
2. Knopf drücken und gedrückt halten.
3. Griff wieder öffnen. Druck auf roten Knopf beibehalten.
4. Das obere Schieberteil ist entriegelt und kann nach links ausgeschwenkt werden.



### Disassembly Instructions

1. Close the handle.
2. Push the button and keep it pushed.
3. Release quickly the front part of the handle.
4. The upper movable shaft is unlocked and can be slid to the left.



### Instrucciones de apertura

1. Cerrar el mango.
2. Presionar el botón y mantenerlo pulsado.
3. Volver a abrir el mango.
4. El vástago superior corredero desengrana y puede girarse hacia la izquierda.



### Consigne d'ouverture

1. Refermez le manche.
2. Appuyez sur le bouton et maintenez-le enfoncé.
3. Rouvrez le manche.
4. La partie supérieure du curseur est débloquée et peut être pivotée vers la gauche.



### Istruzioni per l'apertura

1. Chiudere l'impugnatura.
2. Premere e tenere premuto il pulsante.
3. Riaprire l'impugnatura.
4. La parte superiore scorrevole si sblocca e può essere ruotata a sinistra.

### Hinweis

Durch nochmaliges Schließen des Griffes bleibt der Schaft ausgeschwenkt und das Instrument kann in offenem Zustand sterilisiert werden.

### Advice

If the handle is closed again, the shaft remains swivelled out so that the instrument can be sterilized in open position.

### Nota

Al volver a cerrar el mango de forma normal, el vástago gira y el instrumento puede esterilizarse abierto.

### Remarque

En refermant une nouvelle fois le manche, la tige pivotée reste en position et l'instrument ainsi ouvert peut être stérilisé.

### Nota

Richiudendo l'impugnatura il gambo resta ruotato, in modo da consentire la sterilizzazione dello strumento aperto.

### Zusammensetzen

1. Griff schließen.
2. Knopf drücken und gedrückt halten.
3. Griff öffnen, Schieber einschwenken und nach unten drücken.
4. Griff nochmals schließen – das Instrument ist verriegelt.

### Assembly Instructions

1. Close the handle.
2. Push the button and keep it pushed.
3. Open the handle. Slide back the movable shaft on the instrument and push the shaft downward.
4. Close the handle once again and the instrument is locked.

### Montaje

1. Cerrar el mango.
2. Presionar el botón y mantenerlo pulsado.
3. Abrir el mango, girar el vástago hacia el instrumento y presionar hacia abajo.
4. Volver a cerrar el mango. El instrumento está bloqueado de nuevo.

### Assemblage

1. Fermez le manche.
2. Appuyez sur le bouton et maintenez-le enfoncé.
3. Ouvrez le manche, faites pivoter le curseur et appuyez vers le bas.
4. Rouvrez le manche - l'instrument est verrouillé.

### Rimontaggio

1. Chiudere l'impugnatura.
2. Premere e tenere premuto il pulsante.
3. Aprire l'impugnatura, ritrarre la barra scorrevole e premere verso il basso.
4. Richiudere l'impugnatura – lo strumento è bloccato.



## LubriPen 55-997-01-04

für präzises Ölen von chirurgischen Instrumenten und Medizinprodukten  
for precise lubrication of surgical instruments and medical devices  
para una lubricación perfecta de instrumentos quirúrgicos y dispositivos médicos  
Graissage précis d'instruments chirurgicaux et d'équipements médicaux  
Lubrificazione di precisione di strumenti chirurgici e dispositivi medici



Zerlegen der Instrumente  
Instrument disassembly  
Desmontaje de los instrumentos  
Démontage des instruments  
Smontaggio degli strumenti

[https://www.youtube.com/watch?v=18ul\\_MGOiJ4](https://www.youtube.com/watch?v=18ul_MGOiJ4)



[http://www.youtube.com/watch?v=0tODs7\\_7tYE](http://www.youtube.com/watch?v=0tODs7_7tYE)





Hypophysen- und Schädelbasis-Chirurgie  
Pituitary and skull base surgery  
Cirugía para hipófisis y base del cráneo  
Chirurgie de l'hypophyse et de la base du crâne  
Chirurgia per l'ipofisi e la base cranica

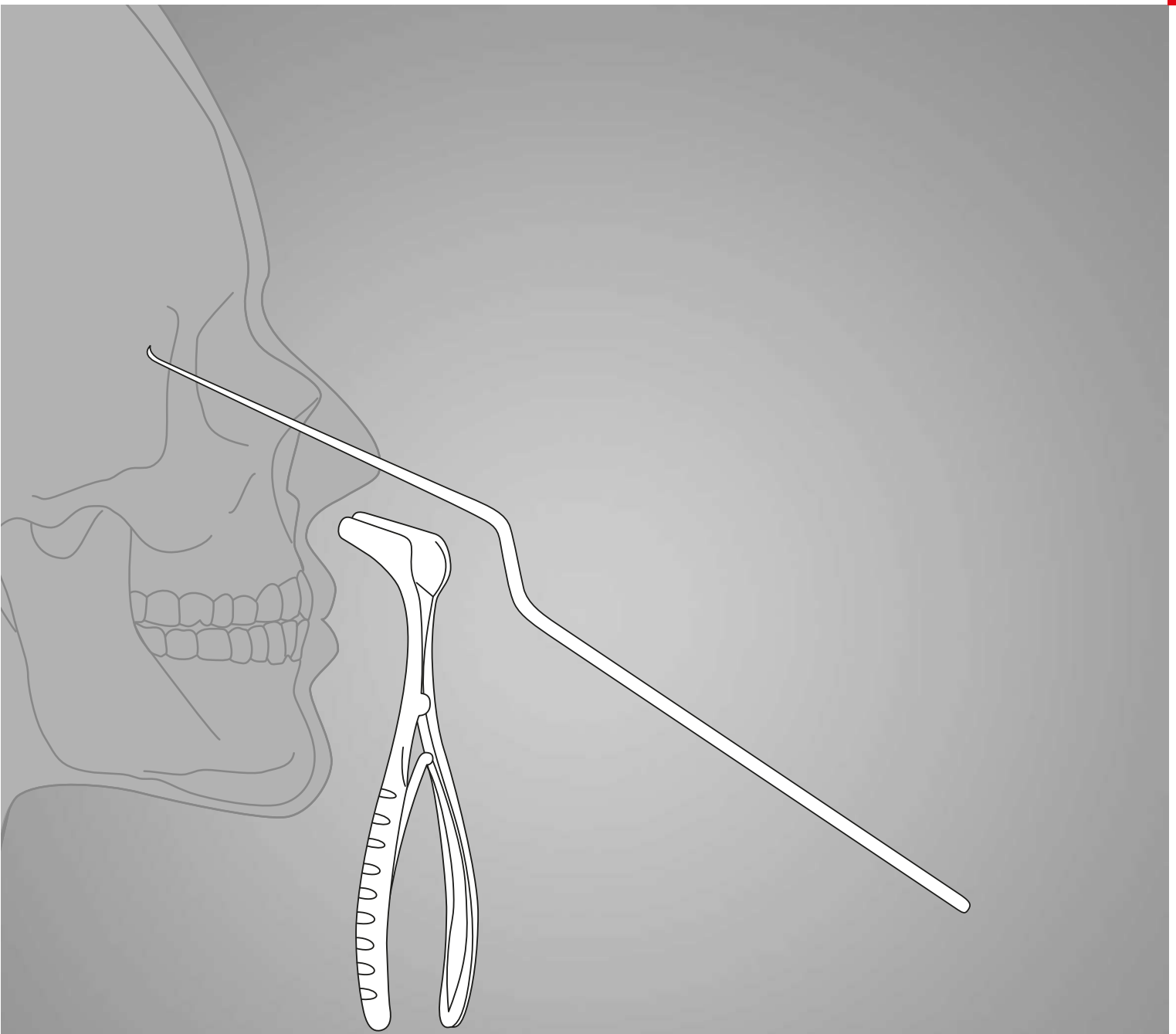

## Mikaeel-Instrumente

Mikaeel instruments  
Instrumentos Mikaeel  
Instruments Mikaeel  
Strumenti Mikaeel

Für mikroskopische Eingriffe  
For microscopic procedures  
Para intervenciones microscópicas  
Pour interventions microscopiques  
Per interventi al microscopio



Mikaeel  
24-843-01-07 -  
24-843-18-07

Bajonett  
Bayonet  
Bayoneta  
Baïonnette  
Baionetta



24-849-99-04

Handgriff  
Handle  
Mango  
Manche  
Manico

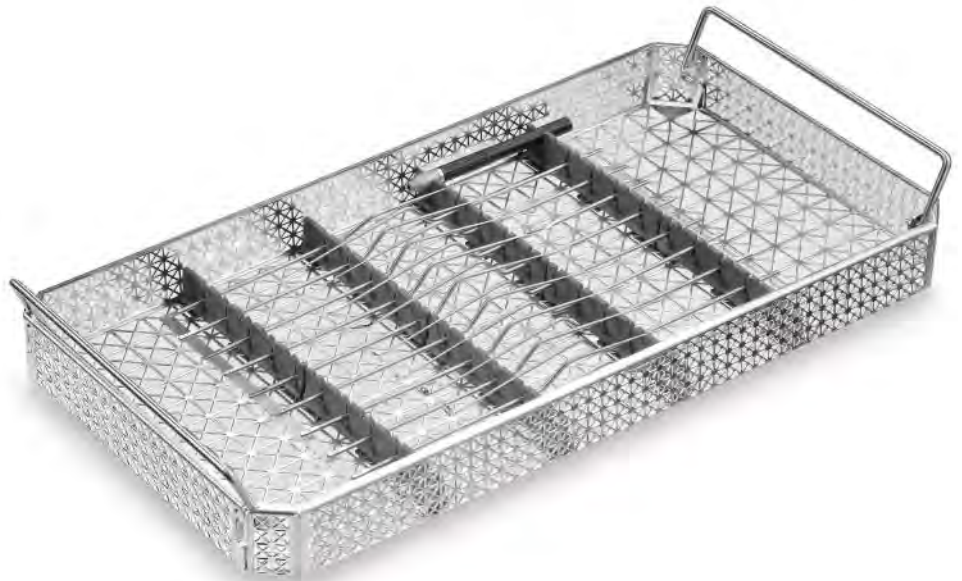

Mikaeel  
24-843-70-04

Instrumenten-Set, Fig. 1-18, 23 cm, inkl. Siebkorb und 2 Handgriffen  
Instrument set, fig. 1-18, 23 cm, incl. mesh tray and 2 handles  
Juego de instrumentos, fig. 1-18, 23 cm, incl. bandeja cribada y 2 mangos  
Set d'instruments, fig. 1-18, 23 cm, incl. panier à maille et 2 manches  
Set di strumenti, fig. 1-18, 23 cm, compr. vassoio reticolato per supporto e 2 manici

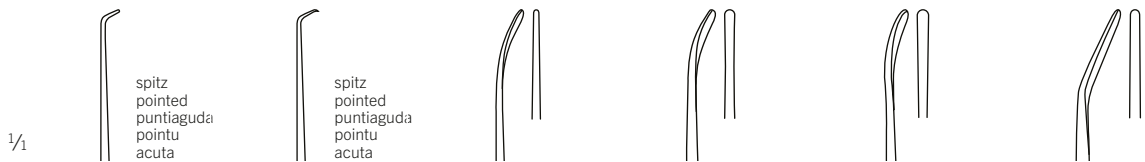
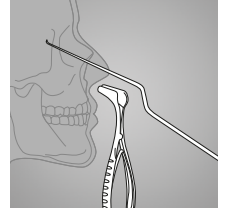

|                  |               |               |               |               |               |               |
|------------------|---------------|---------------|---------------|---------------|---------------|---------------|
| ∅                |               |               | 0,7 mm        | 1,3 mm        | 1,5 mm        | 1,3 mm        |
|                  | <b>Fig. 1</b> | <b>Fig. 2</b> | <b>Fig. 3</b> | <b>Fig. 4</b> | <b>Fig. 5</b> | <b>Fig. 6</b> |
| <b>23 cm, 9"</b> | 24-843-01-07  | 24-843-02-07  | 24-843-03-07  | 24-843-04-07  | 24-843-05-07  | 24-843-06-07  |

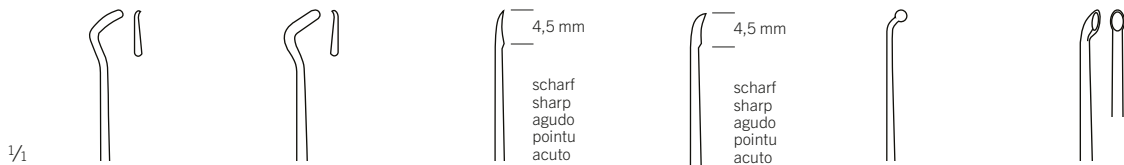

|                  |               |               |               |                |                |                |
|------------------|---------------|---------------|---------------|----------------|----------------|----------------|
| ∅                | 1,2 mm        | 1,2 mm        |               |                | ∅ 1,3 mm       | ∅ 1,9 mm       |
|                  | <b>Fig. 7</b> | <b>Fig. 8</b> | <b>Fig. 9</b> | <b>Fig. 10</b> | <b>Fig. 11</b> | <b>Fig. 12</b> |
| <b>23 cm, 9"</b> | 24-843-07-07  | 24-843-08-07  | 24-843-09-07  | 24-843-10-07   | 24-843-11-07   | 24-843-12-07   |

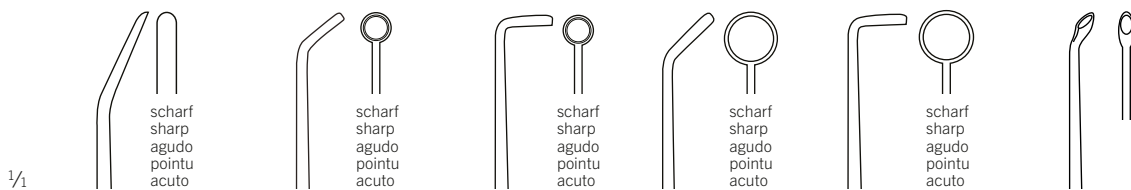

|                  |                |                |                |                |                |                |
|------------------|----------------|----------------|----------------|----------------|----------------|----------------|
| ∅                | 2,5 mm         | ∅ 4,0 mm       | ∅ 4,0 mm       | ∅ 7,0 mm       | ∅ 7,0 mm       | 2,0 mm         |
|                  | <b>Fig. 13</b> | <b>Fig. 14</b> | <b>Fig. 15</b> | <b>Fig. 16</b> | <b>Fig. 17</b> | <b>Fig. 18</b> |
| <b>23 cm, 9"</b> | 24-843-13-07   | 24-843-14-07   | 24-843-15-07   | 24-843-16-07   | 24-843-17-07   | 24-843-18-07   |

## Tew-Instrumente

Tew instruments  
Instrumentos Tew  
Instruments Tew  
Strumenti Tew

Für mikroskopische Eingriffe  
For microscopic procedures  
Para intervenciones microscópicas  
Pour interventions microscopiques  
Per interventi al microscopio



1/2



1/2



Tew  
24-844-01-07 -  
24-844-28-07

Bajonett  
Bayonet  
Bayoneta  
Baïonnette  
Baionetta

24-849-99-04

Handgriff  
Handle  
Mango  
Manche  
Manico

Tew  
24-844-70-04

Instrumenten-Set, Fig. 1-28, 23 cm, inkl. Siebkorb und 2 Handgriffen  
Instrument set, fig. 1-28, 23 cm, incl. mesh tray and 2 handles  
Juego de instrumentos, fig. 1-28, 23 cm, incl. bandeja cribada y 2 mangos  
Set d'instruments, fig. 1-28, 23 cm, incl. panier à maille et 2 manches  
Set di strumenti, fig. 1-28, 23 cm, compr. vassoio reticolato per supporto e 2 manici

# Tew-Instrumente

Tew instruments  
Instrumentos Tew  
Instruments Tew  
Strumenti Tew

# Hypophysen- und Schädelbasis-Chirurgie

Pituitary and skull base surgery  
Cirugía para hipófisis y base del cráneo  
Chirurgie de l'hypophyse et de la base du crâne  
Chirurgia per l'ipofisi e la base cranica

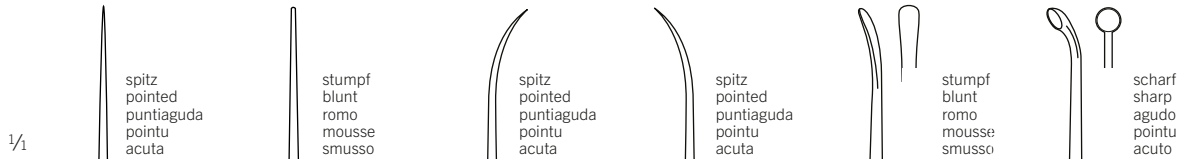
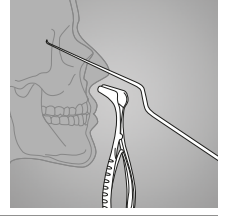

| ∅         | Fig. 1       | Fig. 2       | Fig. 3       | Fig. 4       | 2,9 mm<br>Fig. 5 | ∅ 2,9 mm<br>Fig. 6 |
|-----------|--------------|--------------|--------------|--------------|------------------|--------------------|
| 23 cm, 9" | 24-844-01-07 | 24-844-02-07 | 24-844-03-07 | 24-844-04-07 | 24-844-05-07     | 24-844-06-07       |

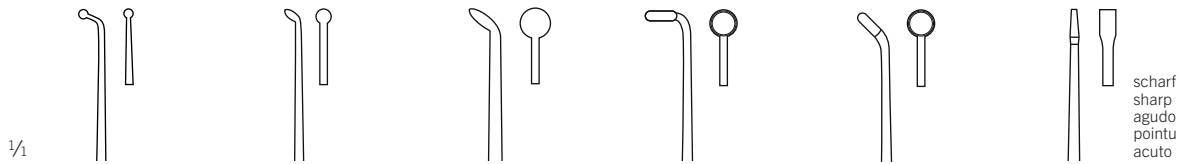

| ∅         | ∅ 1,3 mm<br>Fig. 7 | ∅ 2,0 mm<br>Fig. 8 | ∅ 4,0 mm<br>Fig. 9 | ∅ 3,5 mm<br>Fig. 10 | ∅ 4,0 mm<br>Fig. 11 | 2,0 mm<br>Fig. 12 |
|-----------|--------------------|--------------------|--------------------|---------------------|---------------------|-------------------|
| 23 cm, 9" | 24-844-07-07       | 24-844-08-07       | 24-844-09-07       | 24-844-10-07        | 24-844-11-07        | 24-844-12-07      |

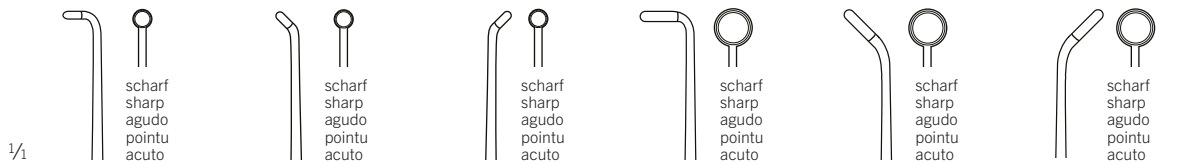

| ∅         | ∅ 2,6 mm<br>Fig. 13 | ∅ 2,6 mm<br>Fig. 14 | ∅ 2,6 mm<br>Fig. 15 | ∅ 5,0 mm<br>Fig. 16 | ∅ 5,0 mm<br>Fig. 17 | ∅ 5,0 mm<br>Fig. 18 |
|-----------|---------------------|---------------------|---------------------|---------------------|---------------------|---------------------|
| 23 cm, 9" | 24-844-13-07        | 24-844-14-07        | 24-844-15-07        | 24-844-16-07        | 24-844-17-07        | 24-844-18-07        |

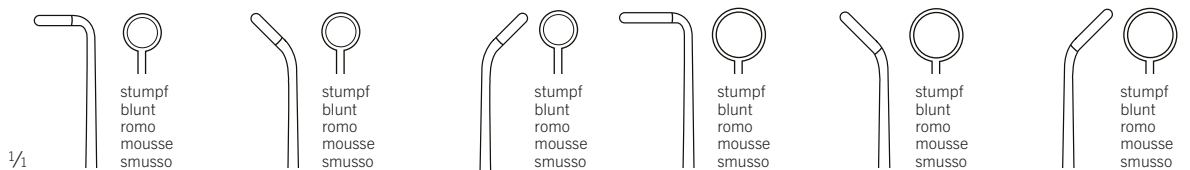

| ∅         | ∅ 5,0 mm<br>Fig. 19 | ∅ 5,0 mm<br>Fig. 20 | ∅ 5,0 mm<br>Fig. 21 | ∅ 7,0 mm<br>Fig. 22 | ∅ 7,0 mm<br>Fig. 23 | ∅ 7,0 mm<br>Fig. 24 |
|-----------|---------------------|---------------------|---------------------|---------------------|---------------------|---------------------|
| 23 cm, 9" | 24-844-19-07        | 24-844-20-07        | 24-844-21-07        | 24-844-22-07        | 24-844-23-07        | 24-844-24-07        |

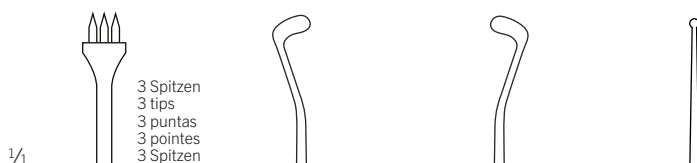

| ∅         | Fig. 25      | 2,3 mm<br>Fig. 26 | 2,3 mm<br>Fig. 27 | ∅ 1,3 mm<br>Fig. 28 |
|-----------|--------------|-------------------|-------------------|---------------------|
| 23 cm, 9" | 24-844-25-07 | 24-844-26-07      | 24-844-27-07      | 24-844-28-07        |

Mikrogabel  
Micro fork  
Micro-horquilla  
Micro-fourche  
Mikrogabel

## Tew-Mikro-Instrumente

Tew micro instruments  
 Micro-instrumentos Tew  
 Micro-instruments Tew  
 Micro-strumenti Tew

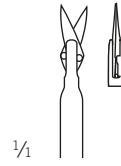

1/1

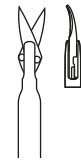

|                        |             |   |  |
|------------------------|-------------|---|--|
|                        |             | Schere, gerade, 2,5 mm<br>Scissors, straight, 2,5 mm<br>Tijeras, recta, 2,5 mm<br>Ciseaux, droite, 2,5 mm<br>Forbici, diritta, 2,5 mm | Schere, gebogen, 2,5 mm<br>Scissors, curved, 2,5 mm<br>Tijeras, curvada, 2,5 mm<br>Ciseaux, courbe, 2,5 mm<br>Forbici, curva, 2,5 mm |
| <b>30 cm / 11 6/8"</b> |             | 24-844-80-07  | 24-844-81-07   |
|                        | <b>360°</b> | 24-844-84-07  | 24-844-85-07   |



1/2

Tew  
 24-844-80-07 -  
 24-844-83-07



1/2

Tew  
 24-844-84-07 -  
 24-844-87-07



1/1



|                        |             |  |   |
|------------------------|-------------|--|---|
|                        |             | Biopsie-Zange<br>Biopsy forceps<br>Pinza de biopsia<br>Forceps de biopsie<br>Pinza per biopsia | Alligator-Zange<br>Alligator forceps<br>Pinza Alligator<br>Forceps Alligator<br>Pinza Alligator |
| <b>30 cm / 11 6/8"</b> |             | 24-844-82-07   | 24-844-83-07  |
|                        | <b>360°</b> | 24-844-86-07   | 24-844-87-07  |

## Pittsburgh-Instrumente

Pittsburgh instruments  
Instrumentos Pittsburgh  
Instruments Pittsburgh  
Strumenti Pittsburgh

## Hypophysen- und Schädelbasis-Chirurgie

Pituitary and skull base surgery  
Cirugía para hipófisis y base del cráneo  
Chirurgie de l'hypophyse et de la base du crâne  
Chirurgia per l'ipofisi e la base cranica

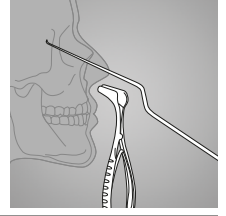

Für endoskopische Eingriffe  
For endoscopic procedures  
Para intervenciones endoscópicas  
Pour interventions endoscopiques  
Per interventi in endoscopia

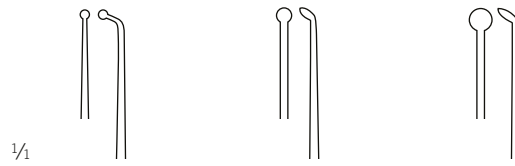

| ∅                | Ø 1,8 mm   | Ø 1,9 mm      | Ø 3,0 mm      |
|------------------|--|---------------|---------------|
|                  | <b>Fig. 1</b>  | <b>Fig. 2</b> | <b>Fig. 3</b> |
| <b>23 cm, 9"</b> |  24-849-01-04 | 24-849-02-04  | 24-849-03-04  |

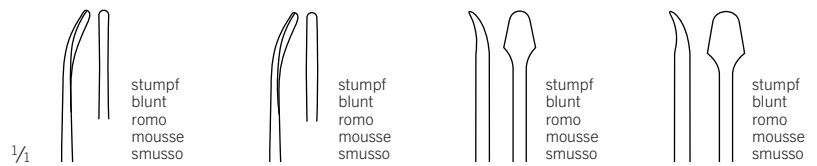

| ∅                | 2,0 mm   | 2,3 mm        | 3,9 mm        | 4,9 mm        |
|------------------|--|---------------|---------------|---------------|
|                  | <b>Fig. 4</b>  | <b>Fig. 5</b> | <b>Fig. 6</b> | <b>Fig. 7</b> |
| <b>23 cm, 9"</b> |  24-849-04-04 | 24-849-05-04  | 24-849-06-04  | 24-849-07-04  |

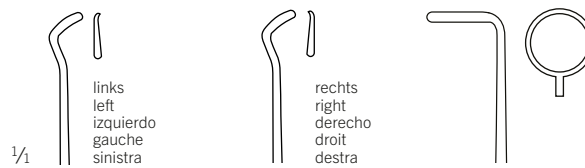

| ∅                | 1,7 mm   | 1,7 mm        | Ø 6,3 mm       |
|------------------|--|---------------|----------------|
|                  | <b>Fig. 8</b>  | <b>Fig. 9</b> | <b>Fig. 10</b> |
| <b>23 cm, 9"</b> |  24-849-08-04 | 24-849-09-04  | 24-849-10-04   |



Pittsburgh  
24-849-01-04 -  
24-849-10-04

gerade  
straight  
recto  
droit  
diritto

24-849-99-04

Handgriff  
Handle  
Mango  
Manche  
Manico



Pittsburgh  
24-849-00-04

Instrumenten-Set, Fig. 1-10, inkl. Siebkorb und 1 Handgriff  
Instrument set, fig. 1-10, incl. mesh tray and 1 handle  
Juego de instrumentos, fig. 1-10, incl. bandeja cribada y 1 mango  
Set d'instruments, fig. 1-10, incl. panier à maille et 1 manche  
Set di strumenti, fig. 1-10, compr. vassoio reticolato per supporto e 1 manico



# Jannetta-Instrumente

Jannetta instruments  
Instrumentos Jannetta  
Instruments Jannetta  
Strumenti Jannetta

## Dissektionsset für Schädelbasis-Chirurgie

Dissection set for pituitary and skull base surgery

Juego de disección para cirugía de la base del cráneo

Set de dissection pour chirurgie de la base du crâne

Set di dissezione per chirurgia per la base cranica

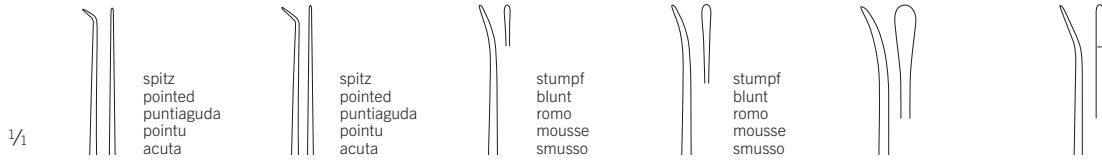

| ∅         | Fig. 1       | Fig. 2       | 1,3 mm<br>Fig. 3 | 1,7 mm<br>Fig. 4 | 2,9 mm<br>Fig. 5 | 2,0 mm<br>Fig. 6 |
|-----------|--------------|--------------|------------------|------------------|------------------|------------------|
| 23 cm, 9" | 24-848-01-07 | 24-848-02-07 | 24-848-03-07     | 24-848-04-07     | 24-848-05-07     | 24-848-06-07     |

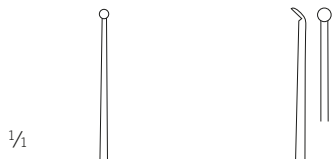

| ∅         | ∅ 1,2 mm<br>Fig. 7 | ∅ 2,0 mm<br>Fig. 8 |
|-----------|--------------------|--------------------|
| 23 cm, 9" | 24-848-07-07       | 24-848-08-07       |



1/2

Jannetta  
24-848-01-07 -  
24-848-08-07



Jannetta  
24-848-00-04

Instrumenten-Set, Fig. 1-8, inkl. Siebkorb  
Instrument set, fig. 1-8, incl. mesh tray  
Juego de instrumentos, fig. 1-8, incl. bandeja  
Set d'instruments, fig. 1-8, incl. panier à maille  
Set di strumenti, fig. 1-8, compr. vassoio reticolato



## Hypophysenzangen

Pituitary forceps

Pinza para hipófisis

Pince pour hypophyse

Pinze per ipofisi

## Hypophysen- und Schädelbasis-Chirurgie

Pituitary and skull base surgery

Cirugía para hipófisis y base del cráneo

Chirurgie de l'hypophyse et de la base du crâne

Chirurgia per l'ipofisi e la base cranica

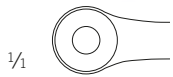
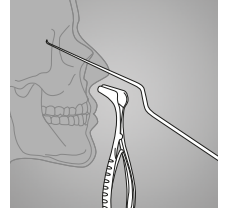

1/1

Landolt

24-855-10-07

20 cm / 7 7/8"

Tumorfasszange

Tumour grasping forceps

Pinzas para sacar tumores

Pince pour saisir des tumeurs

Pinza per afferrare tumori

1/2

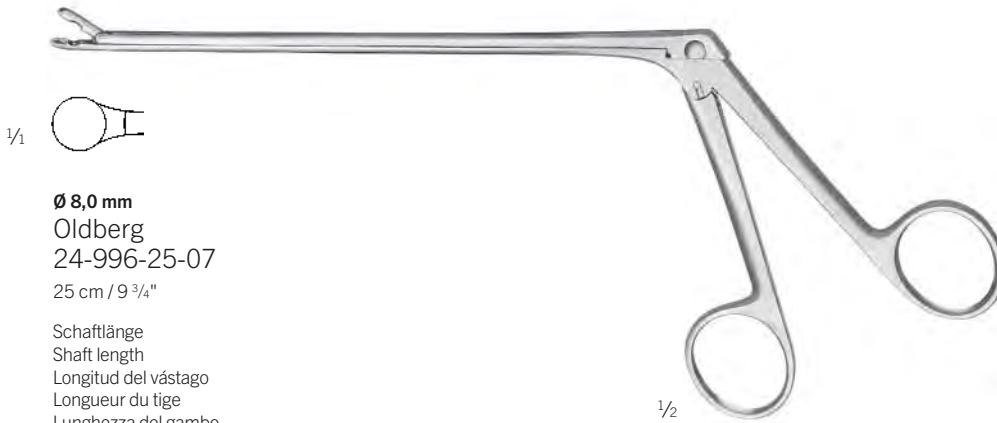

1/1

Ø 8,0 mm

Oldberg

24-996-25-07

25 cm / 9 3/4"

Schaftlänge

Shaft length

Longitud del vástago

Longueur du tige

Lunghezza del gambo

180 mm

1/2

## Hypophysenzangen

Pituitary forceps

Pinza para hipófisis

Pince pour hypophyse

Pinze per ipofisi

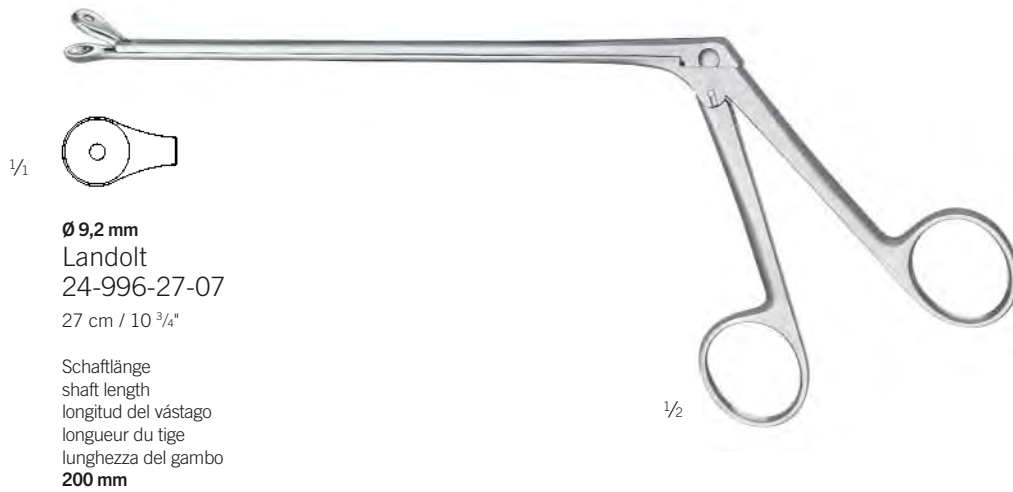

## Hypophysen-Spekula

Pituitary specula

Espéculos para hipófisis

Spéculums pour hypophyse

Specoli per ipofisi

## Hypophysen- und Schädelbasis-Chirurgie

Pituitary and skull base surgery

Cirugía para hipófisis y base del cráneo

Chirurgie de l'hypophyse et de la base du crâne

Chirurgia per l'ipofisi e la base cranica

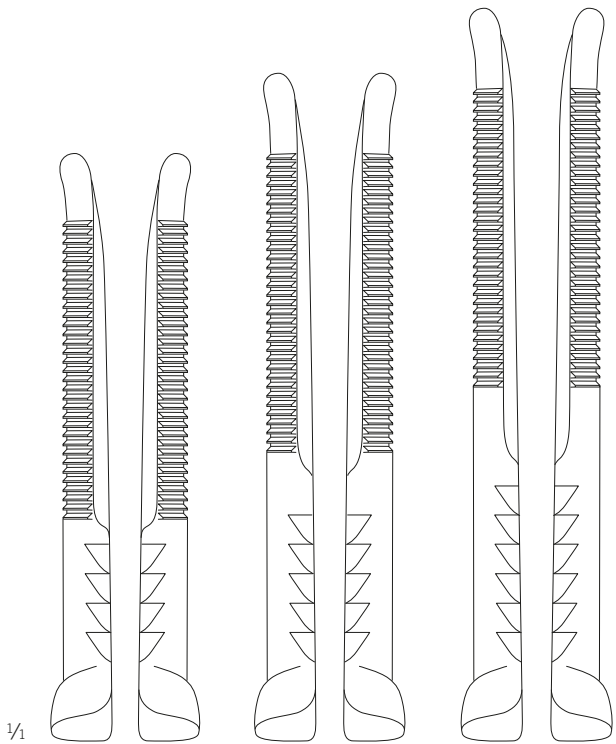
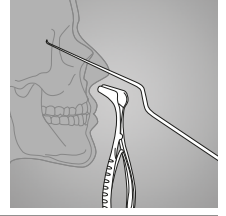

1/1

24-998-08-07  
80 x 13 mm



24-998-09-07  
90 x 13 mm



24-998-10-07  
100 x 15 mm

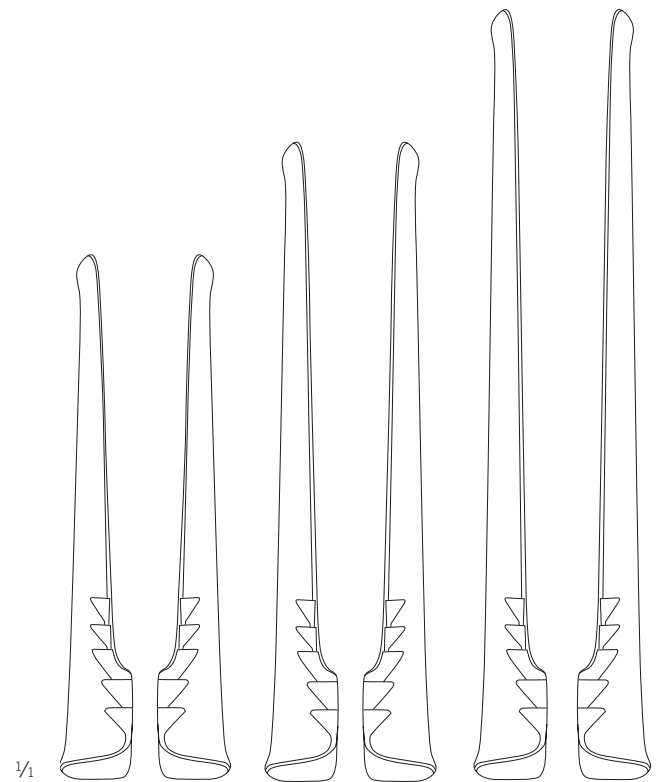

1/1

24-999-07-07  
70 x 16 mm



24-999-09-07  
90 x 16 mm



24-999-11-07  
110 x 16 mm



1/2

1/4

Papavero-Caspar  
24-998-08-07 - 24-998-10-07

inklusive Handgriff  
incl. handle  
incl. mango  
manche compris  
compreso manico



1/2

Cushing-Landolt  
24-999-07-07 - 24-999-11-07

## Nasenspekula

Nasal Specula  
Espéculos nasales  
Spéculums nasaux  
Specoli nasali

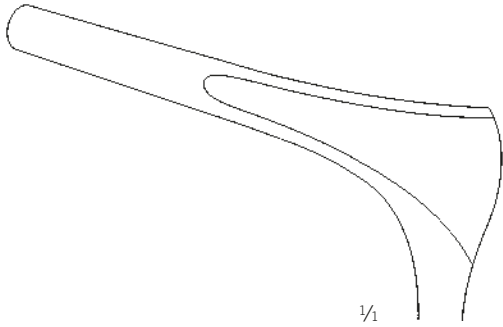

1/1

36-859-75-07

16 cm / 6 2/8"

Blätter  
Blades  
Hojas  
Lames  
Lame  
**75 mm**

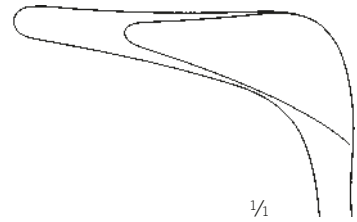

1/1

36-861-45-07

14 cm / 5 4/8"

Blätter  
Blades  
Hojas  
Lames  
Lame  
**45 mm**

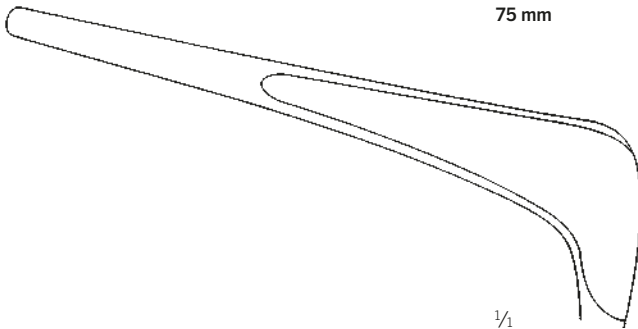

1/1

36-859-90-07

16 cm / 6 2/8"

Blätter  
Blades  
Hojas  
Lames  
Lame  
**85 mm**

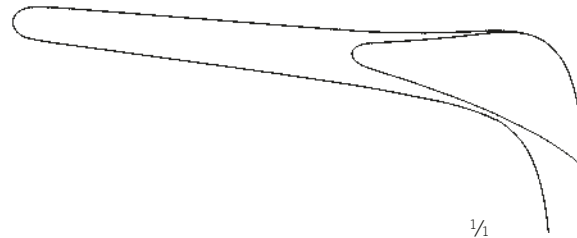

1/1

36-861-75-07

15,5 cm / 6 1/8"

Blätter  
Blades  
Hojas  
Lames  
Lame  
**75 mm**



1/2

Cottle  
36-859-75-07 - 36-859-90-07



1/2

Cottle  
36-861-45-07 - 36-861-75-07

Mikro-Instrumente  
Micro instruments  
Micro-instrumentos  
Micro-instruments  
Micro-strumenti

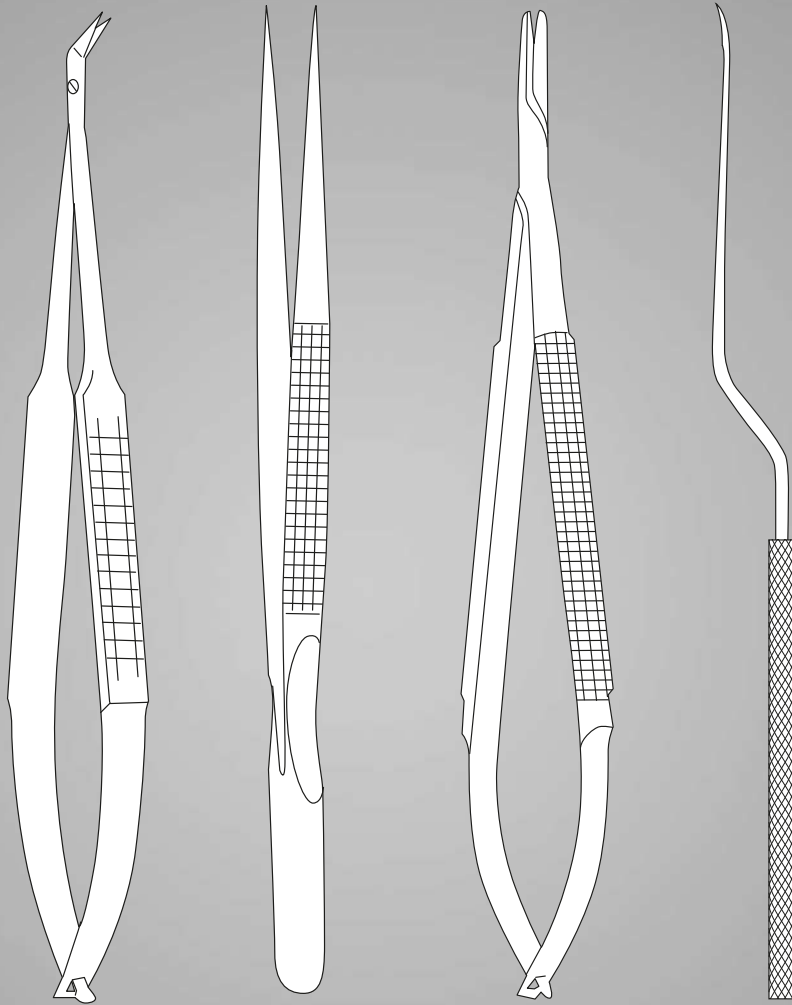



Mikro-Scheren  
Micro Scissors  
Micro-Tijeras  
Micro-Ciseaux  
Micro-Forbici

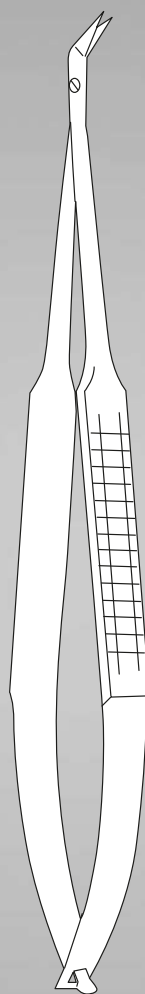

## Kurze Mikro-Scheren

Short Micro Scissors

Micro-Tijeras, corto

Micro-Ciseaux, court





Micro-Forbici, corto



1/2

11-370-01-07 -  
11-371-04-07  
12 cm / 4 9/16"







|  |   |   |   |  |   |   |
|--|---|---|---|--|---|---|
| <br>12 cm / 4 9/16" |  | <b>A</b><br>spitz/spitz<br>sharp/sharp<br>agudo/agudo<br>pointu/pointu<br>appuntato/appuntato | <b>A</b><br>spitz/spitz<br>sharp/sharp<br>agudo/agudo<br>pointu/pointu<br>appuntato/appuntato | spitz/stumpf<br>sharp/blunt<br>agudo/romo<br>pointu/mousse<br>appuntato/smusso | <b>D</b><br>stumpf/stumpf<br>blunt/blunt<br>romo/romo<br>mousse/mousse<br>smusso/smusso | mit Knopf<br>with button<br>con botón<br>avec bouton<br>con bottone |
|  |  | <b>7 mm</b>   | <b>7 mm</b>   | <b>7 mm</b>  | <b>7 mm</b>   | <b>7 mm</b>   |
|                     | 11-370-01-07  | 11-371-01-07  | 11-371-02-07  | 11-371-03-07   | 11-371-04-07  |   |



1/2

11-370-02-07 -  
11-371-08-07  
12 cm / 4 9/16"



|  |   |   |   |  |   |   |
|--|---|---|---|--|---|---|
| <br>12 cm / 4 9/16" |  | <b>A</b><br>spitz/spitz<br>sharp/sharp<br>agudo/agudo<br>pointu/pointu<br>appuntato/appuntato | <b>A</b><br>spitz/spitz<br>sharp/sharp<br>agudo/agudo<br>pointu/pointu<br>appuntato/appuntato | spitz/stumpf<br>sharp/blunt<br>agudo/romo<br>pointu/mousse<br>appuntato/smusso | <b>D</b><br>stumpf/stumpf<br>blunt/blunt<br>romo/romo<br>mousse/mousse<br>smusso/smusso | mit Knopf<br>with button<br>con botón<br>avec bouton<br>con bottone |
|  |  | <b>7 mm</b>   | <b>7 mm</b>   | <b>7 mm</b>  | <b>7 mm</b>   | <b>7 mm</b>   |
|                     | 11-370-02-07  | 11-371-05-07  | 11-371-06-07  | 11-371-07-07   | 11-371-08-07  |   |

A = Adventitia  
 D = Präparation  
 A-SB = Adventitia, ein gezahntes Blatt  
 D-SB = Präparation, ein gezahntes Blatt

A = Adventitia  
 D = Dissection  
 A-SB = Adventitia, one serrated blade  
 D-SB = Dissection, one serrated blade

A = Adventicia  
 D = Disección  
 A-SB = Adventicia, una hoja dentada  
 D-SB = Disección, una hoja dentada

A = Advantice  
 D = Dissection  
 A-SB = Advantice, une lame dentelée  
 D-SB = Dissection, une lame dentelée

A = Avventizia  
 D = Dissezione  
 A-SB = Avventizia, una lama dentata  
 D-SB = Dissezione, una lama dentata



## Mikro-Scheren

Micro Scissors  
Micro-Tijeras  
Micro-Ciseaux  
Micro-Forbici

## Mikro-Scheren

Micro Scissors  
Micro-Tijeras  
Micro-Ciseaux  
Micro-Forbici



1/1

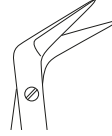
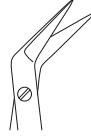

|                       |  | 25°          | 45°          | 60°          | 90°          | 125°         |
|-----------------------|--|--------------|--------------|--------------|--------------|--------------|
|                       |  | <b>10 mm</b> | <b>10 mm</b> | <b>10 mm</b> | <b>10 mm</b> | <b>10 mm</b> |
| <b>18 cm / 7 1/8"</b> |  | 11-400-25-07 | 11-400-45-07 | 11-400-60-07 | 11-400-90-07 | 11-401-00-07 |
| <b>21 cm / 8 2/8"</b> |  | 11-384-25-07 | 11-384-45-07 | 11-384-60-07 | 11-384-90-07 | 11-385-00-07 |

1/2

11-384-25-07 -  
11-401-00-07



1/1

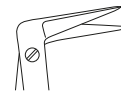
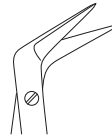
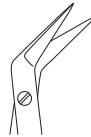

|                       |  | 25°          | 45°          | 60°          | 90°          | 125°         |
|-----------------------|--|--------------|--------------|--------------|--------------|--------------|
|                       |  | <b>10 mm</b> | <b>10 mm</b> | <b>10 mm</b> | <b>10 mm</b> | <b>10 mm</b> |
| <b>18 cm / 7 1/8"</b> |  | 11-412-25-07 | 11-412-45-07 | 11-412-60-07 | 11-412-90-07 | 11-413-00-07 |
| <b>21 cm / 8 2/8"</b> |  | 11-436-25-07 | 11-436-45-07 | 11-436-60-07 | 11-436-90-07 | 11-437-00-07 |

1/2

11-412-25-07 -  
11-437-00-07

# Mikro-Scheren

Micro Scissors

Micro-Tijeras

Micro-Ciseaux

Micro-Forbici



1/2

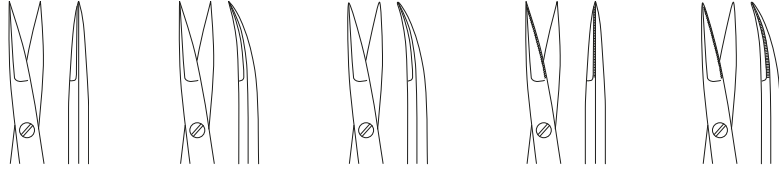

|                |    | A            | A            | D            | A-SB         | D-SB         |
|----------------|----|--------------|--------------|--------------|--------------|--------------|
|                |    | 10 mm        | 10 mm        | 10 mm        | 10 mm        | 10 mm        |
| 15 cm / 7 1/8" | St | 11-710-15-07 | 11-711-15-07 |              |              |              |
| 18 cm / 7 1/8" | St | 11-710-18-07 | 11-711-18-07 | 11-711-19-07 | 11-710-19-07 | 11-711-20-07 |

1/2

11-710-15-07 -  
11-711-20-07



1/2

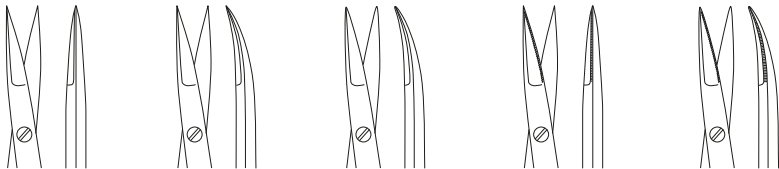

|                |    | A            | A            | D            | A-SB         | D-SB         |
|----------------|----|--------------|--------------|--------------|--------------|--------------|
|                |    | 10 mm        | 10 mm        | 10 mm        | 10 mm        | 10 mm        |
| 15 cm / 7 1/8" | St | 11-712-15-07 | 11-713-15-07 |              |              |              |
| 18 cm / 7 1/8" | St | 11-712-18-07 | 11-713-18-07 | 11-713-19-07 | 11-712-19-07 | 11-713-20-07 |

1/2

11-712-15-07 -  
11-713-20-07

A = Adventitia  
D = Präparation  
A-SB = Adventitia, ein gezahntes Blatt  
D-SB = Präparation, ein gezahntes Blatt

A = Adventitia  
D = Dissection  
A-SB = Adventitia, one serrated blade  
D-SB = Dissection, one serrated blade

A = Adventicia  
D = Disección  
A-SB = Adventicia, una hoja dentada  
D-SB = Disección, una hoja dentada

A = Advantice  
D = Dissection  
A-SB = Advantice, une lame dentelée  
D-SB = Dissection, une lame dentelée

A = Awentizia  
D = Dissezione  
A-SB = Awentizia, una lama dentata  
D-SB = Dissezione, una lama dentata

**Mikro-Scheren, Mikro-Präparierscheren**

Micro Scissors, Micro Dissecting Scissors  
 Micro-Tijeras, Micro-Tijeras de disección  
 Micro-Ciseaux, Micro-Ciseaux à dissection  
 Micro-Forbici, Micro-Forbici per dissezione

**Mikro-Scheren**

Micro Scissors  
 Micro-Tijeras  
 Micro-Ciseaux  
 Micro-Forbici



1/2

**Biemer**

11-758-12-07

12 cm / 4 5/8"

Mikro-Venenschere  
 Micro scissors for veins  
 Micro-tijeras para venas  
 Micro-ciseaux pour les veines  
 Micro-forbici per vene

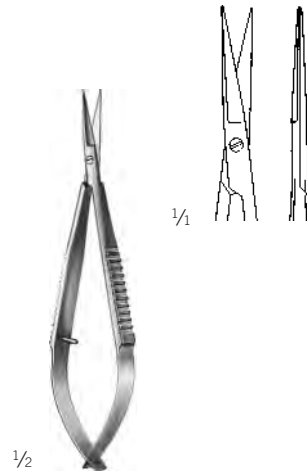

1/2

11-760-09-07

10 cm / 3 7/8"

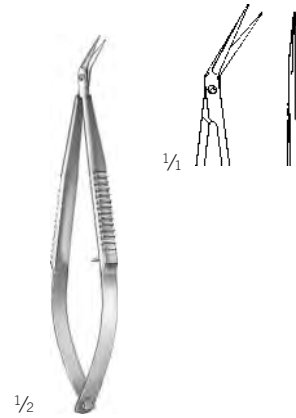

1/2

11-761-09-07

9,5 cm / 3 5/8"



1/2

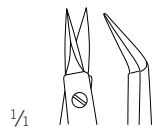

1/4

24-850-01-07

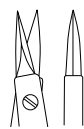

24-850-02-07

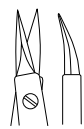

24-850-03-07

**Vannas**

24-850-01-07 - 24-850-03-07

12 cm / 4 5/8"

## Mikro-Scheren

Micro Scissors

Micro-Tijeras

Micro-Ciseaux

Micro-Forbici



1/2

Vannas

24-850-04-07 - 24-850-05-07

16 cm / 6 2/8"

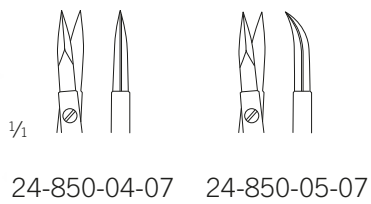

24-850-04-07

24-850-05-07



1/2

Millesi

24-850-10-07 - 24-850-11-07

16 cm / 6 2/8"

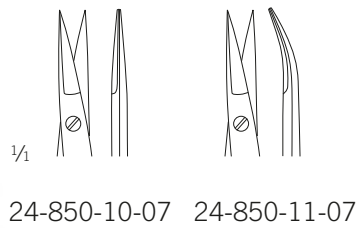

24-850-10-07

24-850-11-07



1/2

Jacobson

24-850-15-07

18,5 cm / 7 2/8"

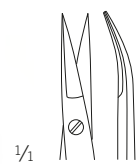

1/2

## Mikro-Scheren

Micro Scissors  
Micro-Tijeras  
Micro-Ciseaux  
Micro-Forbici

## Mikro-Scheren

Micro Scissors  
Micro-Tijeras  
Micro-Ciseaux  
Micro-Forbici

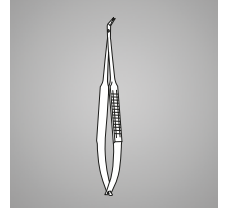

1/2

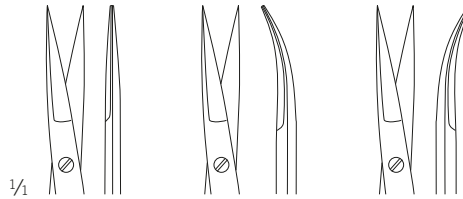

|                         |    |              |              |              |
|-------------------------|----|--------------|--------------|--------------|
| <b>16,5 cm / 6 7/8"</b> | St | 24-850-20-07 | 24-850-21-07 |              |
| <b>20 cm / 7 7/8"</b>   | St | 24-850-22-07 | 24-850-23-07 | 24-850-24-07 |

Yasargil

24-850-20-07 - 24-850-24-07



1/2

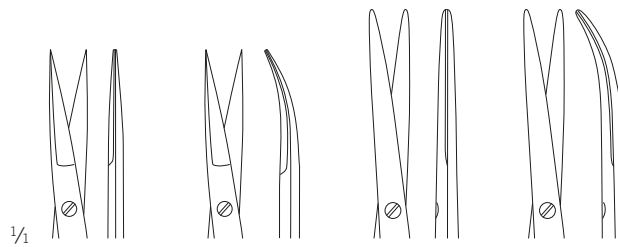

|                         |    | A            | A            | D            | D            |
|-------------------------|----|--------------|--------------|--------------|--------------|
|                         | St | 15 mm        | 15 mm        | 15 mm        | 15 mm        |
| <b>20 cm / 7 7/8"</b>   | St |              |              | 24-850-30-07 | 24-850-31-07 |
| <b>22,5 cm / 8 7/8"</b> | St | 24-850-25-07 | 24-850-26-07 | 24-850-33-07 | 24-850-32-07 |
| <b>24,5 cm / 9 7/8"</b> | St |              | 24-850-28-07 |              |              |

Yasargil

24-850-25-07 - 24-850-33-07

## Mikro-Scheren

Micro Scissors

Micro-Tijeras

Micro-Ciseaux

Micro-Forbici

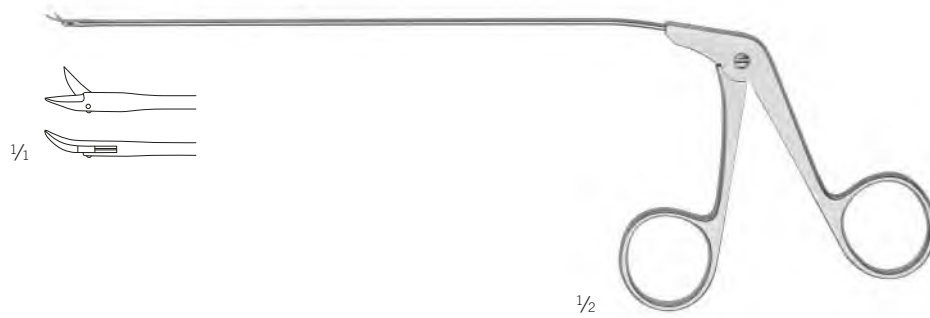

Fahlbusch  
24-850-50-07  
16,5 cm / 6  $\frac{4}{8}$ "

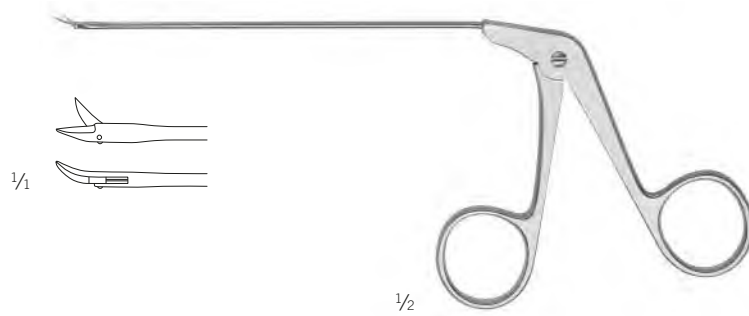

Caspar  
24-850-60-07  
11,5 cm / 4  $\frac{4}{8}$ "

---

Mikro-Pinzetten  
Micro Forceps  
Micro-Pinzas  
Micro-Pinces  
Micro-Pinze

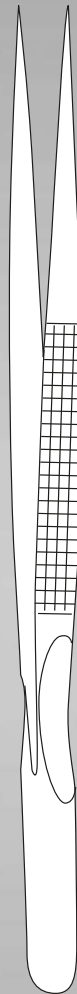

## Kurze Mikro-Pinzetten

Short Micro Forceps

Micro Pinzas, corto

Micro-Pinces, court

Micro-Pinze, corto



1/2

12-552-01-07 -  
12-553-06-07

11 cm / 4 3/8"



|    |              |              |              |
|----|--------------|--------------|--------------|
|    |              |              |              |
| Ø  | 0.15 mm      | 0.20 mm      | 0.30 mm      |
| St | 12-552-01-07 | 12-552-02-07 | 12-552-03-07 |

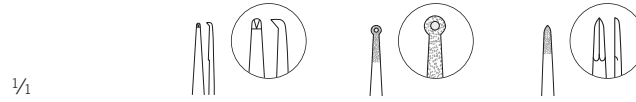

|    |              |              |              |
|----|--------------|--------------|--------------|
|    |              |              |              |
| Ø  | 0.50 mm      | 1.2 mm       |              |
| St | 12-553-01-07 | 12-553-05-07 | 12-553-06-07 |

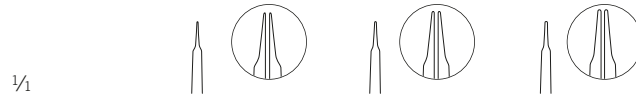

|   |              |              |              |
|---|--------------|--------------|--------------|
|   | VD           | VD           | VD           |
| Ø   | 0.10 mm      | 0.20 mm      | 0.30 mm      |
| gewinkelt/angled/<br>acodada/angulée/<br>angolata | 10°          | 10°          | 10°          |
| St  | 12-552-04-07 | 12-552-05-07 | 12-552-06-07 |



|    |              |              |              |
|----|--------------|--------------|--------------|
|    |              |              |              |
| Ø  | 0.15 mm      | 0.20 mm      | 0.30 mm      |
| St | 12-552-07-07 | 12-552-08-07 | 12-552-09-07 |



|    |              |              |              |
|----|--------------|--------------|--------------|
|    |              |              |              |
| Ø  | 0.50 mm      | 1.2 mm       |              |
| St | 12-553-07-07 | 12-553-08-07 | 12-553-09-07 |

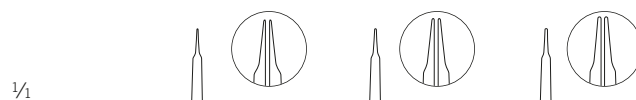

|   |              |              |              |
|---|--------------|--------------|--------------|
|   | VD           | VD           | VD           |
| Ø   | 0.10 mm      | 0.20 mm      | 0.30 mm      |
| gewinkelt/angled/<br>acodada/angulée/<br>angolata | 10°          | 10°          | 10°          |
| St  | 12-552-10-07 | 12-552-11-07 | 12-552-12-07 |



1/2

12-552-07-07 -  
12-553-09-07

11 cm / 4 3/8"



## Mikro-Pinzetten

Micro Forceps  
Micro-Pinzas  
Micro-Pinces  
Micro-Pinze

## Mikro-Pinzetten

Micro Forceps  
Micro-Pinzas  
Micro-Pinces  
Micro-Pinze

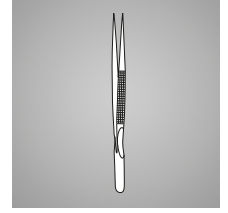

1/2

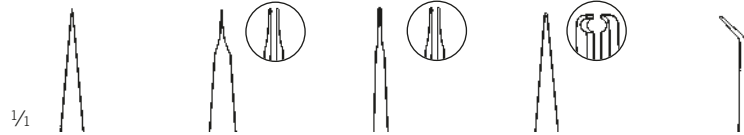

|                  |           | VD           | VD           | Pierse       | 45°          |
|------------------|-----------|--------------|--------------|--------------|--------------|
| 11 cm / 4 3/8"   | Ø 0.30 mm | 0.20 mm      | 0.30 mm      | 0.30 mm      | 0.30 mm      |
|                  | St        | 12-560-00-07 |              | 12-560-05-07 | 12-560-45-07 |
| 13,5 cm / 5 3/8" | St        | 12-561-00-07 | 12-561-02-07 | 12-561-03-07 | 12-561-05-07 |
|                  |           |              |              | 12-561-45-07 |              |

Jeweler mod.  
12-560-00-07 -  
12-561-45-07



1/2

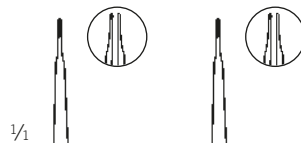

|                |   | VD           | VD           |
|----------------|---|--------------|--------------|
|                | Ø   | 0.20 mm      | 0.30 mm      |
|                | gewinkelt/angled/<br>acodada/angulée/<br>angolata | 10°          | 10°          |
| 11 cm / 4 3/8" | St  | 12-560-02-07 | 12-560-03-07 |

Jeweler mod.  
12-560-02-07 -  
12-560-03-07



1/2



Counter Balance

diamond-coated



|                |    |              |              | 45°          |                  |              | Pierse       |
|----------------|----|--------------|--------------|--------------|------------------|--------------|--------------|
|                | Ø  | 0.30 mm      | 0.30 mm      | 0.30 mm      | R Ø 1.0 x 0.5 mm | VD 0.30 mm   | P 0.30 mm    |
| 15 cm / 5 7/8" | St | 12-562-00-07 | 12-562-01-07 | 12-562-02-07 | 12-562-03-07     | 12-562-04-07 | 12-562-05-07 |
| 18 cm / 7 1/8" | St | 12-563-00-07 | 12-563-01-07 | 12-563-02-07 | 12-563-03-07     | 12-563-04-07 | 12-563-05-07 |

12-562-00-07 -  
12-563-05-07

## Mikro-Pinzetten

Micro Forceps

Micro-Pinzas

Micro-Pinces

Micro-Pinze



1/2

12-564-15-07 -  
12-581-21-09

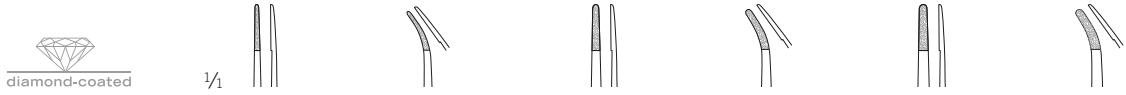

|                       | Ø  | 0.40 mm      | 0.40 mm      | 0.70 mm      | 0.70 mm      | 0.80 mm      | 0.80 mm      |
|-----------------------|----|--------------|--------------|--------------|--------------|--------------|--------------|
| <b>15 cm / 5 7/8"</b> | St | 12-564-15-07 | 12-565-15-07 | 12-566-15-07 | 12-567-15-07 |              |              |
| <b>15 cm / 5 7/8"</b> | Ti | 12-578-15-09 | 12-579-15-09 |              |              | 12-580-15-09 | 12-581-15-09 |
| <b>18 cm / 7 1/8"</b> | St | 12-564-18-07 | 12-565-18-07 | 12-566-18-07 | 12-567-18-07 |              |              |
| <b>18 cm / 7 1/8"</b> | Ti | 12-578-18-09 | 12-579-18-09 |              |              | 12-580-18-09 | 12-581-18-09 |
| <b>21 cm / 8 2/8"</b> | St |              |              | 12-566-21-07 | 12-567-21-07 |              |              |
| <b>21 cm / 8 2/8"</b> | Ti |              |              |              |              | 12-580-21-09 | 12-581-21-09 |



1/2

12-568-15-07 -  
12-583-18-09

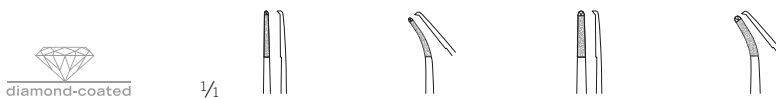

|                       | 1:2     | 1:2          | 1:2          | 1:2          |              |
|-----------------------|---------|--------------|--------------|--------------|--------------|
| Ø                     | 0.40 mm | 0.40 mm      | 0.70 mm      | 0.70 mm      |              |
| <b>15 cm / 5 7/8"</b> | St      | 12-568-15-07 | 12-569-15-07 | 12-570-15-07 | 12-571-15-07 |
| <b>15 cm / 5 7/8"</b> | Ti      | 12-582-15-09 | 12-583-15-09 |              |              |
| <b>18 cm / 7 1/8"</b> | St      | 12-568-18-07 | 12-569-18-07 | 12-570-18-07 | 12-571-18-07 |
| <b>18 cm / 7 1/8"</b> | Ti      | 12-582-18-09 | 12-583-18-09 |              |              |

## Mikropinzetten, Gefäß-Dilatationspinzetten

Micro Forceps, Micro dilating forceps  
 Micro Pinzas, Micro pinza de dilatación  
 Micro-Pinces, Micro pince à dilater  
 Micro-Pinze, Micro pinze per dilatazione

## Mikro-Pinzetten

Micro Forceps  
 Micro-Pinzas  
 Micro-Pinces  
 Micro-Pinze

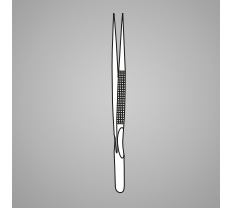

1/2

12-574-15-07 -  
 12-787-21-09

|                | diamond-coated |                |              |              |              | Atrauma      |
|----------------|----------------|----------------|--------------|--------------|--------------|--------------|
|                |                | Ø 1.0 x 0.5 mm | 1.0 x 0.5 mm | 2.0 x 1.0 mm | 2.0 x 1.0 mm | 1.2 mm       |
| 15 cm / 5 7/8" | St             | 12-574-15-07   | 12-774-15-07 | 12-576-15-07 | 12-776-15-07 | 12-589-15-07 |
|                | Ti             | 12-586-15-09   | 12-786-15-09 | 12-588-15-09 | 12-787-15-09 | 12-590-15-09 |
| 18 cm / 7 1/8" | St             | 12-574-18-07   | 12-774-18-07 | 12-576-18-07 | 12-776-18-07 | 12-589-18-07 |
|                | Ti             | 12-586-18-09   | 12-786-18-09 | 12-588-18-09 | 12-787-18-09 | 12-590-18-09 |
| 21 cm / 8 3/8" | St             | 12-574-21-07   | 12-774-21-07 | 12-576-21-07 | 12-776-21-07 | 12-589-21-07 |
|                | Ti             | 12-586-21-09   | 12-786-21-09 | 12-588-21-09 | 12-787-21-09 | 12-590-21-09 |



1/2

12-591-00-07 -  
 12-592-05-07

|                | diamond-coated |              |              |              |                  | 45°          | Pierse       |
|----------------|----------------|--------------|--------------|--------------|------------------|--------------|--------------|
|                |                | Ø 0.30 mm    | 0.30 mm      | 0.30 mm      | R Ø 1.0 x 0.5 mm | VD* 0.30 mm  | P 0.40 mm    |
| 15 cm / 5 7/8" | St             | 12-591-00-07 | 12-591-01-07 | 12-591-02-07 | 12-591-03-07     | 12-591-04-07 | 12-591-05-07 |
| 18 cm / 7 1/8" | St             | 12-592-00-07 | 12-592-01-07 | 12-592-02-07 | 12-592-03-07     | 12-592-04-07 | 12-592-05-07 |

\*VD = Gefäßdilator  
 Vascular dilator  
 Dilatador vascular  
 Dilatateur vasculaire  
 Dilatatore vascolare

## Mikro-Pinzetten

Micro Forceps

Micro Pinzas

Micro-Pinces

Micro-Pinze



1/2

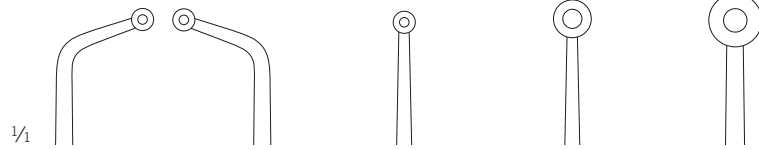

|                       |   | Samii         | Samii         | Yasargil-Samii | Yasargil-Samii | Yasargil-Samii |
|-----------------------|---|---------------|---------------|----------------|----------------|----------------|
|                       | ∅ | <b>3.0 mm</b> | <b>3.0 mm</b> | <b>3.0 mm</b>  | <b>5.0 mm</b>  | <b>7.0 mm</b>  |
| <b>23 cm / 9"</b>     |   | 24-852-01-07  | 24-852-02-07  |                |                |                |
| <b>24 cm / 9 1/8"</b> |   |               |               | 24-852-10-07   | 24-852-11-07   | 24-852-12-07   |



|                       |    | Yasargil      | Yasargil      | Yasargil      | Yasargil      | Yasargil     |
|-----------------------|----|---------------|---------------|---------------|---------------|--------------|
|                       | ∅  | <b>3.0 mm</b> | <b>5.0 mm</b> | <b>0.6 mm</b> | <b>0.9 mm</b> |              |
|                       | mm |               |               |               |               | <b>1:2</b>   |
| <b>18 cm / 7 1/8"</b> |    |               |               | 24-852-70-07  | 24-852-71-07  | 24-852-72-07 |
| <b>20 cm / 7 7/8"</b> |    |               |               | 24-852-73-07  | 24-852-74-07  |              |
| <b>22 cm / 8 5/8"</b> |    | 24-852-25-07  | 24-852-26-07  | 24-852-75-07  | 24-852-76-07  |              |

24-852-01-07 -  
24-852-76-07



1/2

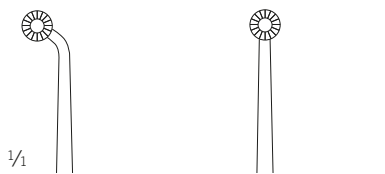

24-852-60-07

**5 mm**  
abgewinkelt  
angled  
acodado  
coudé  
angolato

24-852-61-07

**5 mm**  
bajonett  
bayonet  
bayoneta  
baïonnette  
baionetta

Hunt  
24-852-60-07 -  
24-852-61-07

Mikro-Nadelhalter  
Micro Needle Holders  
Micro-Porta-agujas  
Micro-Porte-aiguilles  
Micro-Portaghi

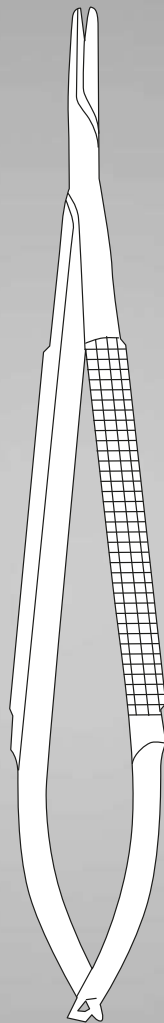

## Mikro-Nadelhalter

Micro Needle Holders

Micro-Porta-agujas

Micro-Porte-aiguilles

Micro-Portaghi



8-0 - 9-0

1/1



1/2

|                       |    | mit Sperre<br>with lock<br>con trinquete<br>avec cran d'arrêt<br>con arresto | mit Sperre<br>with lock<br>con trinquete<br>avec cran d'arrêt<br>con arresto | ohne Sperre<br>without lock<br>sin trinquete<br>sans cran d'arrêt<br>senza arresto | ohne Sperre<br>without lock<br>sin trinquete<br>sans cran d'arrêt<br>senza arresto |
|-----------------------|----|--|--|--|--|
|                       | Ø  | <b>0.40 mm</b>   | <b>0.40 mm</b>   | <b>0.40 mm</b>   | <b>0.40 mm</b>   |
| <b>15 cm / 5 7/8"</b> | St | 20-002-15-07   | 20-003-15-07   | 20-004-15-07   | 20-005-15-07   |
|                       | Ti | 20-016-15-09   | 20-017-15-09   | 20-018-15-09   | 20-019-15-09   |
| <b>18 cm / 7 1/8"</b> | St | 20-002-18-07   | 20-003-18-07   | 20-004-18-07   | 20-005-18-07   |
|                       | Ti | 20-016-18-09   | 20-017-18-09   | 20-018-18-09   | 20-019-18-09   |

20-002-15-07 -  
20-019-18-09



6-0 - 8-0

1/1



1/2

|                       |    | mit Sperre<br>with lock<br>con trinquete<br>avec cran d'arrêt<br>con arresto | mit Sperre<br>with lock<br>con trinquete<br>avec cran d'arrêt<br>con arresto | ohne Sperre<br>without lock<br>sin trinquete<br>sans cran d'arrêt<br>senza arresto | ohne Sperre<br>without lock<br>sin trinquete<br>sans cran d'arrêt<br>senza arresto |
|-----------------------|----|--|--|--|--|
|                       | Ø  | <b>0.80 mm</b>   | <b>0.80 mm</b>   | <b>0.80 mm</b>   | <b>0.80 mm</b>   |
| <b>15 cm / 5 7/8"</b> | St | 20-010-15-07   | 20-011-15-07   | 20-012-15-07   | 20-013-15-07   |
|                       | Ti | 20-020-15-09   | 20-021-15-09   | 20-022-15-09   | 20-023-15-09   |
| <b>18 cm / 7 1/8"</b> | St | 20-010-18-07   | 20-011-18-07   | 20-012-18-07   | 20-013-18-07   |
|                       | Ti | 20-020-18-09   | 20-021-18-09   | 20-022-18-09   | 20-023-18-09   |
| <b>21 cm / 8 2/8"</b> | St | 20-010-21-07   | 20-011-21-07   | 20-012-21-07   | 20-013-21-07   |
|                       | Ti | 20-020-21-09   | 20-021-21-09   | 20-022-21-09   | 20-023-21-09   |
| <b>23 cm / 9"</b>     | St | 20-010-23-07   | 20-011-23-07   | 20-012-23-07   | 20-013-23-07   |
|                       | Ti | 20-020-23-09   | 20-021-23-09   | 20-022-23-09   | 20-023-23-09   |

20-010-15-07 -  
20-023-23-09

## Mikro-Nadelhalter

Micro Needle Holders  
Micro-Porta-agujas  
Micro-Porte-aiguilles  
Micro-Portaghi

## Mikro-Nadelhalter

Micro Needle Holders  
Micro-Porta-agujas  
Micro-Porte-aiguilles  
Micro-Portaghi



1/1



1/2

20-030-15-07 -  
20-033-23-09

|                |    | mit Sperre<br>with lock<br>con trinquete<br>avec cran d'arrêt<br>con arresto | mit Sperre<br>with lock<br>con trinquete<br>avec cran d'arrêt<br>con arresto | ohne Sperre<br>without lock<br>sin trinquete<br>sans cran d'arrêt<br>senza arresto | ohne Sperre<br>without lock<br>sin trinquete<br>sans cran d'arrêt<br>senza arresto |
|----------------|----|--|--|--|--|
|                | Ø  | 1.2 mm   | 1.2 mm   | 1.2 mm   | 1.2 mm   |
| 15 cm / 5 7/8" | St | 20-030-15-07   | 20-031-15-07   | 20-032-15-07   | 20-033-15-07   |
|                | Ti | 20-030-15-09   | 20-031-15-09   | 20-032-15-09   | 20-033-15-09   |
| 18 cm / 7 1/8" | St | 20-030-18-07   | 20-031-18-07   | 20-032-18-07   | 20-033-18-07   |
|                | Ti | 20-030-18-09   | 20-031-18-09   | 20-032-18-09   | 20-033-18-09   |
| 21 cm / 8 2/8" | St | 20-030-21-07   | 20-031-21-07   | 20-032-21-07   | 20-033-21-07   |
|                | Ti | 20-030-21-09   | 20-031-21-09   | 20-032-21-09   | 20-033-21-09   |
| 23 cm / 9"     | St | 20-030-23-07   | 20-031-23-07   | 20-032-23-07   | 20-033-23-07   |
|                | Ti | 20-030-23-09   | 20-031-23-09   | 20-032-23-09   | 20-033-23-09   |



1/2

20-048-18-07 -  
20-051-18-07  
18 cm / 7 1/8"

1/1



|                |    | mit Sperre<br>with lock<br>con trinquete<br>avec cran d'arrêt<br>con arresto | mit Sperre<br>with lock<br>con trinquete<br>avec cran d'arrêt<br>con arresto | ohne Sperre<br>without lock<br>sin trinquete<br>sans cran d'arrêt<br>senza arresto | ohne Sperre<br>without lock<br>sin trinquete<br>sans cran d'arrêt<br>senza arresto |
|----------------|----|--|--|--|--|
| 18 cm / 7 1/8" | St | 20-048-18-07   | 20-049-18-07   | 20-050-18-07   | 20-051-18-07   |

## Mikro-Nadelhalter

Micro Needle Holders

Micro-Porta-agujas

Micro-Porte-aiguilles

Micro-Portaghi



1/2



20-298-10-07  
10,5 cm / 4 1/8"



20-298-11-07  
11,5 cm / 4 4/8"



20-299-10-07  
10,5 cm / 4 1/8"



20-299-11-07  
11,5 cm / 4 4/8"

Barraquer-Troutman  
20-298-10-07 -  
20-299-11-07



1/2

1/1



|                         |    | ohne Sperre<br>without lock<br>sin trinquete<br>sans cran d'arrêt<br>senza arresto | ohne Sperre<br>without lock<br>sin trinquete<br>sans cran d'arrêt<br>senza arresto | mit Sperre<br>with lock<br>con trinquete<br>avec cran d'arrêt<br>con arresto |
|-------------------------|----|--|--|--|
| <b>11,5 cm / 4 4/8"</b> | St | 20-300-11-07   |  |  |
| <b>13,5 cm / 5 3/8"</b> | St |  | 20-300-13-07   | 20-300-14-07   |

Barraquer  
20-300-11-07 -  
20-300-14-07



## Mikro-Nadelhalter

Micro Needle Holders  
Micro-Porta-agujas  
Micro-Porte-aiguilles  
Micro-Portaghi

## Mikro-Nadelhalter

Micro Needle Holders  
Micro-Porta-agujas  
Micro-Porte-aiguilles  
Micro-Portaghi



Barraquer  
20-301-13-07

13,5 cm / 5 3/8"

sehr feines Maul  
very delicate jaw  
boca muy delicada  
mors très fin  
morso strafino



Castroviejo-Fino  
20-302-01-07

13 cm / 5 1/8"

sehr feines Maul  
very delicate jaw  
boca muy delicada  
mors très fin  
morso strafino



Castroviejo-Fino  
20-303-01-07

13 cm / 5 1/8"

sehr feines Maul  
very delicate jaw  
boca muy delicada  
mors très fin  
morso strafino



Castroviejo-Fino  
20-303-09-07

9 cm / 3 4/8"



Castroviejo-Fino  
20-304-01-07

13 cm / 5 1/8"

sehr feines Maul, mit Sperre  
very delicate jaw, with lock  
boca muy delicada, con cierre  
mors très fin, avec serrure  
morso strafino, con fermo



Castroviejo-Fino  
20-304-09-07

9 cm / 3 4/8"



Castroviejo-Fino  
20-305-01-07

13 cm / 5 1/8"

sehr feines Maul, mit Sperre  
very delicate jaw, with lock  
boca muy delicada, con cierre  
mors très fin, avec serrure  
morso strafino, con fermo

## Mikro-Nadelhalter

Micro Needle Holders

Micro-Porta-agujas

Micro-Porte-aiguilles

Micro-Portaghi



1/1



20-306-14-07  
14,5 cm / 5 7/8"

20-307-14-07  
14,5 cm / 5 7/8"

1/2

Castroviejo  
20-306-14-07 -  
20-307-14-07



1/1



20-308-14-07  
14,5 cm / 5 7/8"

20-309-14-07  
14,5 cm / 5 7/8"

1/2

Castroviejo  
20-308-14-07 -  
20-309-14-07



1/1



20-310-14-07  
14,5 cm / 5 7/8"

20-311-14-07  
14,5 cm / 5 7/8"

1/2

Castroviejo  
20-310-14-07 -  
20-311-14-07



1/1



1/2

Castroviejo  
20-313-14-07  
14,5 cm / 5 7/8"

## Mikro-Nadelhalter

Micro Needle Holders  
Micro-Porta-agujas  
Micro-Porte-aiguilles  
Micro-Portaghi

## Mikro-Nadelhalter

Micro Needle Holders  
Micro-Porta-agujas  
Micro-Porte-aiguilles  
Micro-Portaghi



**TC GOLD**

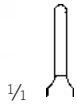

6-0 - 12-0  
Smooth

Hepp-Scheidel  
20-602-18-07

18,5 cm / 7 2/8"

1/2



safety-wave

diamond-coated

2-0 - 4-0



|                |    | mit Sperre<br>with lock<br>con trinquete<br>avec cran d'arrêt<br>con arresto | mit Sperre<br>with lock<br>con trinquete<br>avec cran d'arrêt<br>con arresto | ohne Sperre<br>without lock<br>sin trinquete<br>sans cran d'arrêt<br>senza arresto | ohne Sperre<br>without lock<br>sin trinquete<br>sans cran d'arrêt<br>senza arresto |
|----------------|----|--|--|--|--|
|                | Ø  | 2.0 mm   | 2.0 mm   | 2.0 mm   | 2.0 mm   |
| 15 cm / 5 7/8" | St | 20-606-15-07   | 20-605-15-07   | 20-608-15-07   | 20-607-15-07   |
| 18 cm / 7 1/8" | St | 20-606-18-07   | 20-605-18-07   | 20-608-18-07   | 20-607-18-07   |
| 21 cm / 8 2/8" | St | 20-606-21-07   | 20-605-21-07   | 20-608-21-07   | 20-607-21-07   |
| 23 cm / 9"     | St | 20-606-23-07   | 20-605-23-07   | 20-608-23-07   | 20-607-23-07   |

1/2

20-605-15-07 -  
20-608-23-07

# Mikro-Nadelhalter

Micro Needle Holders

Micro-Porta-agujas

Micro-Porte-aiguilles

Micro-Portaghi



2-0 - 5-0



diamond-coated



safety-wave



1/1



5-0 - 8-0



Micro

1/2

Jaboma  
20-610-18-07  
18 cm / 7 1/8"



1/2



1/1

20-613-19-07  
19 cm / 7 4/8"



20-613-23-07  
23 cm / 9"

Heavy Duty  
20-613-19-07 -  
20-613-23-07

## Kurze Mikro-Nadelhalter

Short Micro Needle Holders  
 Micro Porta-agujas, corto  
 Micro porte-aiguilles, court  
 Micro Portaghi, corto

## Mikro-Nadelhalter

Micro Needle Holders  
 Micro-Porta-agujas  
 Micro-Porte-aiguilles  
 Micro-Portaghi



1/2



8-0 - 9-0

1/1



|    |   |  |  |  |  |
|----|---|--|--|--|--|
|    | ● | mit Sperre<br>with lock<br>con trinquete<br>avec cran d'arrêt<br>con arresto | mit Sperre<br>with lock<br>con trinquete<br>avec cran d'arrêt<br>con arresto | ohne Sperre<br>without lock<br>sin trinquete<br>sans cran d'arrêt<br>senza arresto | ohne Sperre<br>without lock<br>sin trinquete<br>sans cran d'arrêt<br>senza arresto |
| Ø  |   | 0.40 mm  | 0.40 mm  | 0.40 mm  | 0.40 mm  |
| St |   | 20-614-02-07   | 20-615-01-07   | 20-614-01-07   | 20-615-02-07   |

20-614-01-07 -  
 20-615-02-07  
 14,5 cm / 5 7/8"



1/2



8-0 - 9-0

1/1



|    |   |  |  |  |  |
|----|---|--|--|--|--|
|    | ● | mit Sperre<br>with lock<br>con trinquete<br>avec cran d'arrêt<br>con arresto | ohne Sperre<br>without lock<br>sin trinquete<br>sans cran d'arrêt<br>senza arresto | ohne Sperre<br>without lock<br>sin trinquete<br>sans cran d'arrêt<br>senza arresto | mit Sperre<br>with lock<br>con trinquete<br>avec cran d'arrêt<br>con arresto |
| Ø  |   | 0.40 mm  | 0.40 mm  | 0.40 mm  | 0.40 mm  |
| St |   | 20-614-04-07   | 20-615-04-07   | 20-614-03-07   | 20-615-03-07   |

20-614-03-07 -  
 20-615-04-07  
 14,5 cm / 5 7/8"

## Mikro-Nadelhalter

Micro Needle Holders

Micro-Porta-agujas

Micro-Porte-aiguilles

Micro-Portaghi

## TC GOLD



1/1

20-620-00-07

14,5 cm / 5 7/8"

Mikroprofil  
micro profile  
perfil micro  
profil micro  
profilo micro



20-620-01-07

14,5 cm / 5 7/8"

Mikroprofil  
micro profile  
perfil micro  
profil micro  
profilo micro



20-620-14-07

14,5 cm / 5 7/8"

glattes Maul  
smooth jaw  
boca lisa  
mors lisse  
morso liscio



20-620-18-07

18 cm / 7 1/8"

Mikroprofil  
micro profile  
perfil micro  
profil micro  
profilo micro



1/2



1/1

20-620-21-07

22 cm / 8 5/8"

Mikroprofil  
micro profile  
perfil micro  
profil micro  
profilo micro



20-621-14-07

14,5 cm / 5 7/8"

glattes Maul  
smooth jaw  
boca lisa  
mors lisse  
morso liscio



20-621-18-07

18 cm / 7 1/8"

Mikroprofil  
micro profile  
perfil micro  
profil micro  
profilo micro



20-621-21-07

22 cm / 8 5/8"

Mikroprofil  
micro profile  
perfil micro  
profil micro  
profilo micro



Castroviejo  
20-620-00-07 -  
20-621-21-07

## Mikro-Nadelhalter

Micro Needle Holders  
Micro-Porta-agujas  
Micro-Porte-aiguilles  
Micro-Portaghi

## Mikro-Nadelhalter

Micro Needle Holders  
Micro-Porta-agujas  
Micro-Porte-aiguilles  
Micro-Portaghi



## TC GOLD



Castroviejo  
20-624-13-07

12,5 cm / 4 7/8"

mit Sperre  
with lock  
con cierre  
avec serrure  
con fermo



Barraquer  
20-626-13-07

13 cm / 5 1/8"

mit Sperre  
with lock  
con cierre  
avec serrure  
con fermo



Barraquer  
20-628-13-07

13 cm / 5 1/8"

ohne Sperre  
without lock  
sin trinquete  
sans cran d'arrêt  
senza arresto

## Mikro-Nadelhalter

Micro Needle Holders

Micro-Porta-agujas

Micro-Porte-aiguilles

Micro-Portaghi



1/1



24-851-10-07  
20 cm / 7 7/8"



24-851-11-07  
20 cm / 7 7/8"



24-851-12-07  
22,5 cm / 8 7/8"



24-851-13-07  
22,5 cm / 8 7/8"

1/2

Yasargil  
24-851-10-07 -  
24-851-13-07



Mikro-Instrumente  
Micro instruments  
Micro-instrumentos  
Micro-instruments  
Micro-strumenti

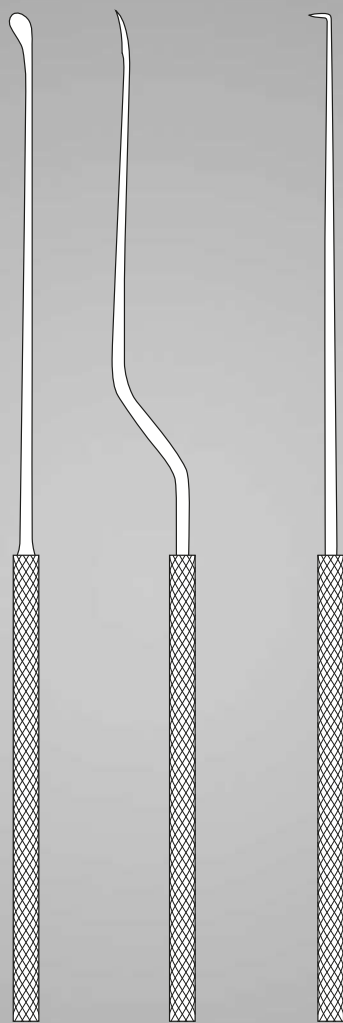

# Mikro-Instrumente

Micro instruments  
 Micro-instrumentos  
 Micro instruments  
 Micro-strumenti



**4 mm**  
 24-537-14-07  
 14 cm / 5 4/8"



**5,5 mm**  
 24-537-24-07  
 23,5 cm / 9 2/8"



1/2

24-537-14-07 -  
 24-537-24-07

Intimspatel  
 Intima Spatulas  
 Espátulas para la íntima  
 Spatules pour la tunique interne  
 Spatole per intima



1/4  
**2,5 mm**  
 90°  
 24-830-19-07



**1,4 mm**  
 90°  
 24-831-19-07



1/2

24-830-19-07 -  
 24-831-19-07

19 cm / 7 4/8"  
 Mikro-Häkchen  
 Micro hooklet  
 Micro-gancho  
 Micro-crochet  
 Micro-uncino



1/4  
 ?  
 24-835-13-07  
 13 cm / 5 1/8"



24-835-18-07  
 18 cm / 7 1/8"

1/2

Frazier  
 24-835-13-07 -  
 24-835-18-07

## Mikro-Instrumente

Micro instruments  
Micro-instrumentos  
Micro instruments  
Micro-strumenti

## Mikro-Instrumente

Micro instruments  
Micro-instrumentos  
Micro instruments  
Micro-strumenti

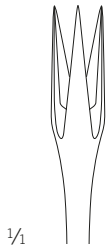

1/1

24-853-01-07

Ø 8 mm



24-853-02-07

Ø 5 mm

### Yasargil

24-853-01-07 - 24-853-02-07

20 cm / 7 7/8"

Tumorgabel  
Tumor fork  
Horquilla para tumor  
Fourche à tumeurs  
Forchetta per tumore

1/2

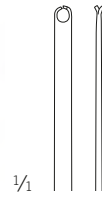

1/1

Ø 1,8 mm

24-853-03-07

18,5 cm / 7 3/8"

Gewebekralle  
Tissue forceps  
Pinza para tejido  
Pince à tissus  
Pinze per tessuto

1/2

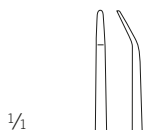

1/1



| Ø      |    | Samii        | Samii        |
|--------|----|--------------|--------------|
| 1,0 mm | St | 24-854-01-07 |              |
| 1,5 mm | St | 24-854-02-07 | 24-854-09-07 |
| 2,0 mm | St | 24-854-03-07 |              |
| 2,5 mm | St | 24-854-04-07 |              |
| 3,0 mm | St | 24-854-05-07 | 24-854-10-07 |
| 3,5 mm | St | 24-854-06-07 |              |
| 4,0 mm | St | 24-854-07-07 |              |
| 4,5 mm | St |              | 24-854-11-07 |
| 5,0 mm | St | 24-854-08-07 |              |
| 6,0 mm | St |              | 24-854-12-07 |

### Samii

24-854-01-07 - 24-854-12-07

23 cm / 9"

Tumormesser  
Tumor knife  
Bisturí para tumor  
Couteau à tumeurs  
Coltello per tumore

1/2

## Mikro-Instrumente

Micro instruments  
Micro-instrumentos  
Micro instruments  
Micro-strumenti

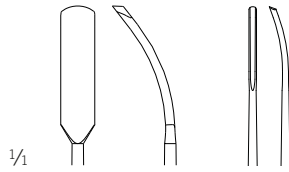

|                | ∅  | 4,5 mm       | 1,0 mm       |
|----------------|----|--------------|--------------|
| 20 cm / 7 7/8" | St |              | 24-856-04-07 |
| 23 cm / 9"     | St | 24-856-01-07 |              |

Caspar  
24-856-01-07 -  
24-856-04-07

Mikro-Dissektor, gerade, scharf  
Micro dissector, straight, sharp  
Micro-dissector, recto, agudo  
Micro-dissecteur, droit, pointu  
Micro-dissettore, diritto, acuto

1/2

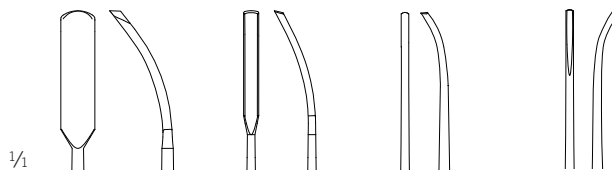

|                | ∅  | 4,5 mm       | 2,0 mm       | 1,0 mm       | 1,0 mm       |
|----------------|----|--------------|--------------|--------------|--------------|
| 20 cm / 7 7/8" | St |              |              | 24-856-05-07 | 24-856-06-07 |
| 23 cm / 9"     | St | 24-856-02-07 | 24-856-03-07 |              |              |

Caspar  
24-856-02-07 -  
24-856-06-07

Mikro-Dissektor, bajonett, scharf  
Micro dissector, bayonet, sharp  
Micro-dissector, bayoneta, agudo  
Micro-dissecteur, baïonnette, pointu  
Micro-dissettore, baionetta, acuto

1/2

## Mikro-Instrumente

Micro instruments  
Micro-instrumentos  
Micro instruments  
Micro-strumenti

## Mikro-Instrumente

Micro instruments  
Micro-instrumentos  
Micro instruments  
Micro-strumenti

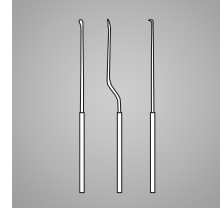

Samii  
24-858-01-07  
23 cm / 9"  
Lanzettenmesser  
Lancet knife  
Cuchillo de lanceta  
Couteau lancéolaire  
Coltello lanceolato

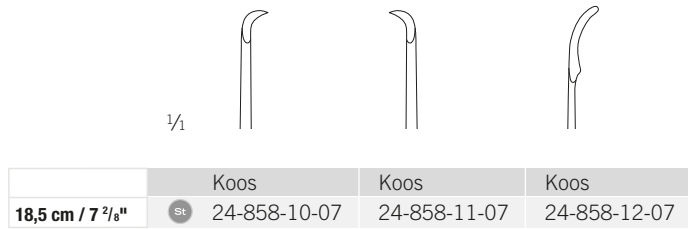

|                         |    |              |              |              |
|-------------------------|----|--------------|--------------|--------------|
|                         |    | Koos         | Koos         | Koos         |
| <b>18,5 cm / 7 2/8"</b> | st | 24-858-10-07 | 24-858-11-07 | 24-858-12-07 |

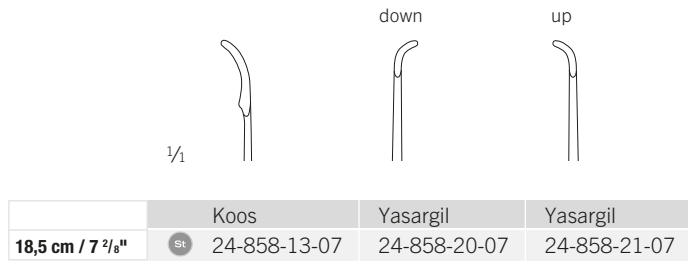

|                         |    |              |              |              |
|-------------------------|----|--------------|--------------|--------------|
|                         |    | Koos         | Yasargil     | Yasargil     |
| <b>18,5 cm / 7 2/8"</b> | st | 24-858-13-07 | 24-858-20-07 | 24-858-21-07 |

24-858-10-07 -  
24-858-21-07  
Mikrogefäßmesser, bajonett  
Micro vascular knife, bayoneta  
Micro-cuchillo vascular, bayoneta  
Micro-couteau vasculaire, baïonnette  
Micro-coltello vascolare, baionetta



Jacobson  
24-858-30-07  
18,5 cm / 7 2/8"  
Mikrogefäßmesser  
Micro vascular knife  
Micro-cuchillo vascular  
Micro-couteau vasculaire  
Micro-coltello vascolare

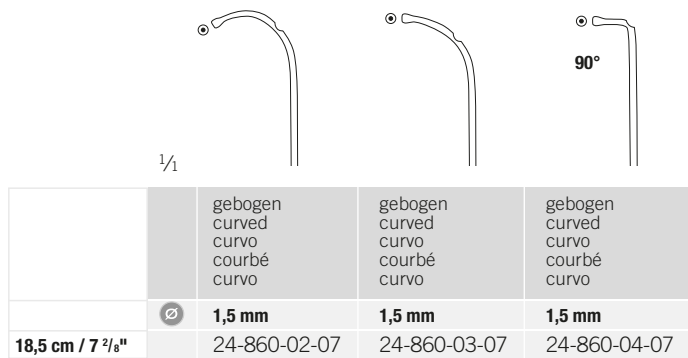

|                         |   |   |   |   |
|-------------------------|---|---|---|---|
|                         |   | gebogen<br>curved<br>curvo<br>courbé<br>curvo | gebogen<br>curved<br>curvo<br>courbé<br>curvo | gebogen<br>curved<br>curvo<br>courbé<br>curvo |
|                         | ∅ | <b>1,5 mm</b>                                 | <b>1,5 mm</b>                                 | <b>1,5 mm</b>                                 |
| <b>18,5 cm / 7 2/8"</b> |   | 24-860-02-07                                  | 24-860-03-07                                  | 24-860-04-07                                  |

Yasargil  
24-860-02-07 -  
24-860-04-07  
18,5 cm / 7 2/8"  
Fadenführer  
Suture guide  
Pinza porta-suturas  
Pince guide-fil  
Pinza porta-filo

## Mikro-Instrumente

Micro instruments  
Micro-instrumentos  
Micro instruments  
Micro-strumenti



1/2

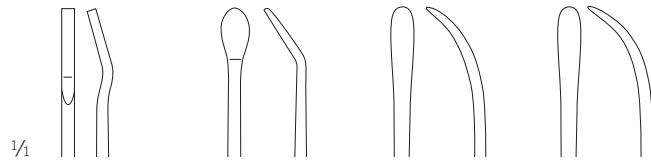

|                  | ∅  | 1,4 mm       | 4,0 mm       | 3,0 mm       | 3,9 mm       |
|------------------|----|--------------|--------------|--------------|--------------|
| 18,5 cm / 7 2/8" | St | 24-862-01-07 | 24-862-02-07 | 24-862-03-07 | 24-862-04-07 |

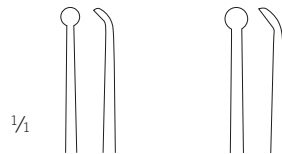

|            | ∅  | 2,5 mm       | 3,0 mm       |
|------------|----|--------------|--------------|
| 23 cm / 9" | St | 24-862-10-07 | 24-862-11-07 |

Yasargil  
24-862-01-07 -  
24-862-11-07

Mikro-Raspatorium, gerade  
Micro raspatory, straight  
Micro-raspador, recto  
Micro-raspatoire, droit  
Micro-raspatore, diritto



1/2

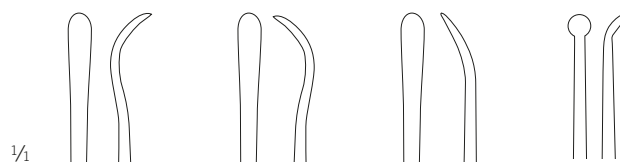

|                  | ∅  | 3,0 mm       | 3,0 mm       | 3,0 mm       | 3,0 mm       |
|------------------|----|--------------|--------------|--------------|--------------|
| 18,5 cm / 7 2/8" | St | 24-862-05-07 | 24-862-06-07 | 24-862-07-07 |              |
| 23 cm / 9"       | St |              |              |              | 24-862-20-07 |

Yasargil  
24-862-05-07 -  
24-862-20-07

Mikro-Raspatorium, bajonett  
Micro raspatory, bayonet  
Micro-raspador, bayoneta  
Micro-raspatoire, baionnette  
Micro-raspatore, baionetta

## Mikro-Instrumente

Micro instruments  
Micro-instrumentos  
Micro instruments  
Micro-strumenti

## Mikro-Instrumente

Micro instruments  
Micro-instrumentos  
Micro instruments  
Micro-strumenti



1/2

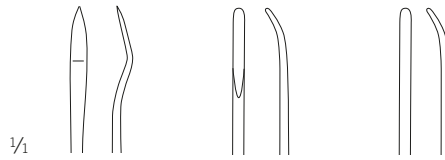

|                  | Ø  | 2,6 mm       | 2,2 mm       | 2,2 mm       |
|------------------|----|--------------|--------------|--------------|
| 18,5 cm / 7 3/8" | St | 24-863-01-07 |              |              |
| 23 cm / 9"       | St |              | 24-863-10-07 | 24-863-12-07 |

Yasargil  
24-863-01-07 -  
24-863-12-07

Mikro-Dissektor, gerade  
Micro dissector, straight  
Micro-dissector, recto  
Micro-dissecteur, droit  
Micro-dissettore, diritto



1/2

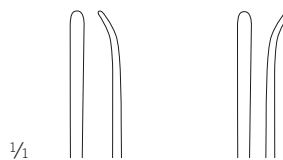

|            | Ø  | 2,2 mm       | 2,0 mm       |
|------------|----|--------------|--------------|
| 23 cm / 9" | St | 24-863-11-07 | 24-863-13-07 |

Yasargil  
24-863-11-07 -  
24-863-13-07

Mikro-Dissektor, bajonett  
Micro dissector, bayonet  
Micro-dissector, bayoneta  
Micro-dissecteur, baïonnette  
Micro-dissettore, baionetta

## Mikro-Instrumente

Micro instruments  
Micro-instrumentos  
Micro instruments  
Micro-strumenti

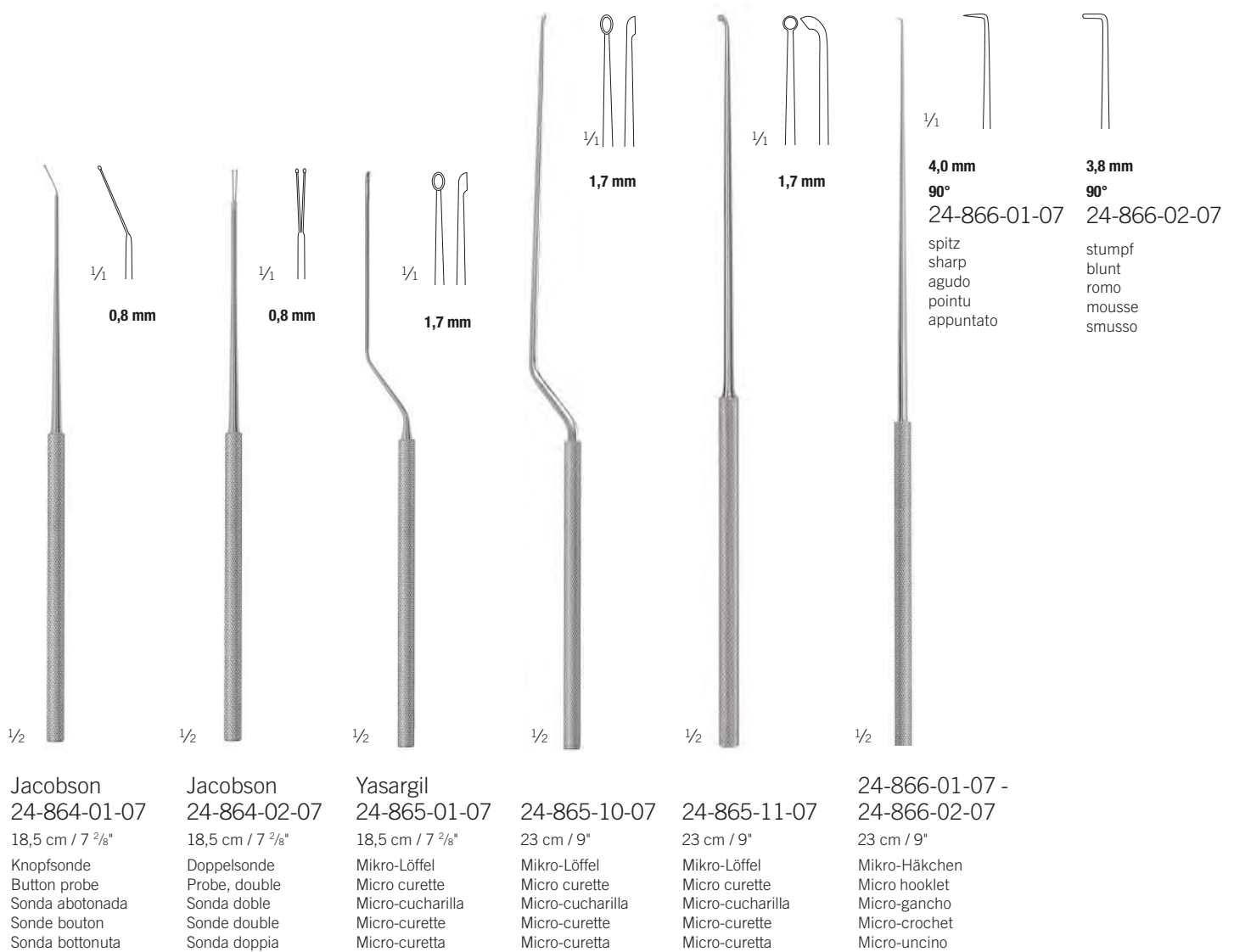

1/2

1/2

1/2

1/2

1/2

1/2

Jacobson  
24-864-01-07  
18,5 cm / 7 2/8"  
Knopfsonde  
Button probe  
Sonda abotonada  
Sonde bouton  
Sonda bottonuta

Jacobson  
24-864-02-07  
18,5 cm / 7 2/8"  
Doppelsonde  
Probe, double  
Sonda doble  
Sonde double  
Sonda doppia

Yasargil  
24-865-01-07  
18,5 cm / 7 2/8"  
Mikro-Löffel  
Micro curette  
Micro-cucharilla  
Micro-curette  
Micro-curetta

24-865-10-07  
23 cm / 9"  
Mikro-Löffel  
Micro curette  
Micro-cucharilla  
Micro-curette  
Micro-curetta

24-865-11-07  
23 cm / 9"  
Mikro-Löffel  
Micro curette  
Micro-cucharilla  
Micro-curette  
Micro-curetta

24-866-01-07 -  
24-866-02-07  
23 cm / 9"  
Mikro-Häkchen  
Micro hooklet  
Micro-gancho  
Micro-crochet  
Micro-uncino

4,0 mm  
90°  
24-866-01-07  
spitz  
sharp  
agudo  
pointu  
appuntato

3,8 mm  
90°  
24-866-02-07  
stumpf  
blunt  
romo  
mousse  
smusso



## Mikro-Instrumente

Micro instruments  
Micro-instrumentos  
Micro instruments  
Micro-strumenti

## Mikro-Instrumente

Micro instruments  
Micro-instrumentos  
Micro instruments  
Micro-strumenti



1/2

Krayenbühl  
24-940-01-07 -  
24-940-04-07

Mikro-Häkchen  
Micro hooklet  
Micro-gancho  
Micro-crochet  
Micro-uncino

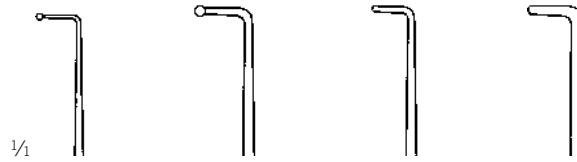

|                       |    | Krayenbühl    | Krayenbühl    | Krayenbühl    | Krayenbühl    |
|-----------------------|----|---------------|---------------|---------------|---------------|
|                       | ∅  | <b>0,6 mm</b> | <b>1,1 mm</b> | <b>0,6 mm</b> | <b>0,8 mm</b> |
|                       |    | <b>90°</b>    | <b>90°</b>    | <b>90°</b>    | <b>90°</b>    |
|                       |    | <b>3,3 mm</b> | <b>4,5 mm</b> | <b>3,2 mm</b> | <b>3,2 mm</b> |
| <b>19 cm / 7 1/8"</b> | St | 24-940-01-07  | 24-940-02-07  | 24-940-03-07  | 24-940-04-07  |



1/2

Caspar  
24-942-05-07 -  
24-942-11-07

Mikro-Häkchen  
Micro hooklet  
Micro-gancho  
Micro-crochet  
Micro-uncino

isoliert  
insulated  
aislado  
isolée  
isolato

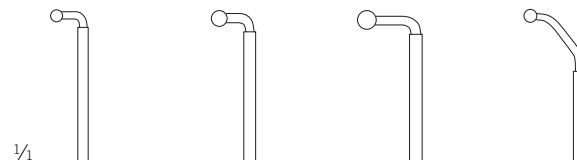

|                         |    | Caspar        | Caspar        | Caspar        | Caspar        |
|-------------------------|----|---------------|---------------|---------------|---------------|
|                         | ∅  | <b>1,8 mm</b> | <b>2,0 mm</b> | <b>2,5 mm</b> | <b>1,8 mm</b> |
|                         |    | <b>90°</b>    | <b>90°</b>    | <b>90°</b>    | <b>45°</b>    |
|                         |    | <b>5 mm</b>   | <b>7 mm</b>   | <b>9 mm</b>   | <b>11 mm</b>  |
| <b>24,5 cm / 9 5/8"</b> | St | 24-942-05-07  | 24-942-07-07  | 24-942-09-07  | 24-942-11-07  |

# Rhoton-Set

Rhoton-Set  
 Juego Rhoton  
 Kit Rhoton  
 Set Rhoton



|    | Fig. 1       | Fig. 2       | Fig. 3       | Fig. 4       |
|----|--------------|--------------|--------------|--------------|
| St | 24-857-01-07 | 24-857-02-07 | 24-857-03-07 | 24-857-04-07 |
| Ti | 24-857-01-09 | 24-857-02-09 | 24-857-03-09 | 24-857-04-09 |



|    | Fig. 5       | Fig. 6       | Fig. 7       | Fig. 8       |
|----|--------------|--------------|--------------|--------------|
| St | 24-857-05-07 | 24-857-06-07 | 24-857-07-07 | 24-857-08-07 |
| Ti | 24-857-05-09 | 24-857-06-09 | 24-857-07-09 | 24-857-08-09 |



|    | Fig. 9       | Fig. 10      | Fig. 11      | Fig. 12      |
|----|--------------|--------------|--------------|--------------|
| St | 24-857-09-07 | 24-857-10-07 | 24-857-11-07 | 24-857-12-07 |
| Ti | 24-857-09-09 | 24-857-10-09 | 24-857-11-09 | 24-857-12-09 |



|    | Fig. 13      | Fig. 14      | Fig. 15      | Fig. 16      |
|----|--------------|--------------|--------------|--------------|
| St | 24-857-13-07 | 24-857-14-07 | 24-857-15-07 | 24-857-16-07 |
| Ti | 24-857-13-09 | 24-857-14-09 | 24-857-15-09 | 24-857-16-09 |



|    | Fig. 17      | Fig. 18      | Fig. 19      |
|----|--------------|--------------|--------------|
| St | 24-857-17-07 | 24-857-18-07 | 24-857-19-07 |
| Ti | 24-857-17-09 | 24-857-18-09 | 24-857-19-09 |



Rhoton  
 24-857-01-07 -  
 24-857-19-09  
 19 cm / 7 4/8"

## Rhoton-Set

Rhoton-Set  
Juego Rhoton  
Kit Rhoton  
Set Rhoton

## Mikro-Instrumente

Micro instruments  
Micro-instrumentos  
Micro-instruments  
Micro-strumenti

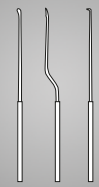

Rhoton  
24-857-00-07

Rhoton-Set, Instrumente aus Edelstahl, bestehend aus Fig. 1 - 19  
Rhoton set, stainless steel instruments, consisting of fig. 1 - 19  
Juego Rhoton, instrumentos acero inoxidable, formado por fig. 1 - 19  
Kit Rhoton, instruments acier inoxydable, composé de fig. 1 - 19  
Set Rhoton, strumenti acciaio inossidabile, consistente in fig. 1 - 19



Rhoton  
24-857-00-09

Rhoton-Set, Instrumente aus Titan, bestehend aus Fig. 1 - 19  
Rhoton set, titanium instruments, consisting of fig. 1 - 19  
Juego Rhoton, instrumentos titanio, formado por fig. 1 - 19  
Kit Rhoton, instruments titane, composé de fig. 1 - 19  
Set Rhoton, strumenti titanio, consistente in fig. 1 - 19



55-803-50-04

Siebkorb für Rhoton-Set, mit Deckel und Fixierelementen (ohne Instrumente)  
Mesh tray for Rhoton set with lid and fixing elements (no instruments)  
Bandeja cribada para juego Rhoton, con tapa e elemento de fijación (sin instrumentos)  
Panier à maille pour kit Rhoton, avec couvercle et éléments de fixation (sans instruments)  
Vassoio per set Rhoton, con coperchio e elemento di fissaggio (senza strumenti)



Allgemeines Instrumentarium

General instruments

Instrumentos generales

Instrumentation générale

Strumentario generale

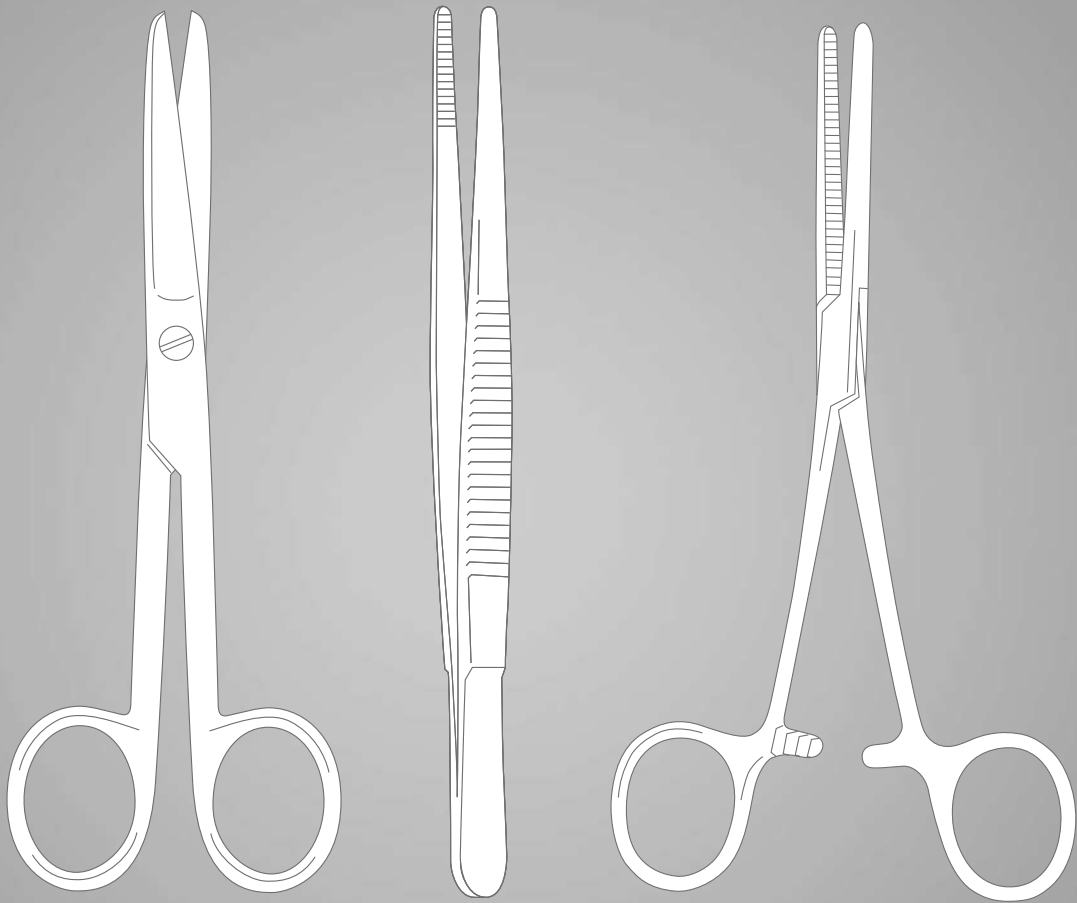



Skalpelle  
Scalpels  
Bisturíes  
Bistouris  
Bisturi

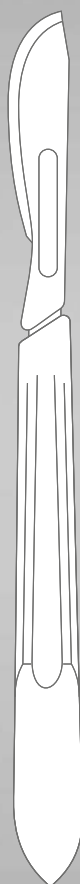

## Skalpellgriffe

Scalpel Handles

Mangos de bisturí

Manches pour bistouris

Manici per bisturi



 Fig. 18 - 36

1/2 **Nr. 4**

10-100-04-07

13,5 cm / 5 3/8"

massiv  
solid  
macizo  
solide  
pieno



 Fig. 18 - 36

1/2 **Nr. 4L**

10-104-41-07

21 cm / 8 2/8"

massiv  
solid  
macizo  
solide  
pieno



 Fig. 10 - 15

1/2 **Nr. 3**

10-130-03-07

12 cm / 4 6/8"

massiv  
solid  
macizo  
solide  
pieno



 Fig. 10 - 15

1/2 **Nr. 3L**

10-133-31-07

21,5 cm / 8 4/8"

massiv, lang  
solid, long  
macizo, largo  
solide, long  
pieno, lungo



## Skalpellgriffe

Scalpel Handles

Mangos de bisturí

Manches pour bistouris

Manici per bisturi

## Skalpelle

Scalpels

Bisturíes

Bistouris

Bisturi



 Fig. 10 - 17

1/2 **Nr. 3XL**

10-135-01-07

26 cm / 10 2/8"

massiv, lang  
solid, long  
macizo, largo  
solide, long  
pieno, lungo



 Fig. 10 - 17

1/2 **Nr. 7**

10-137-07-07

16 cm / 6 2/8"

massiv  
solid  
macizo  
solide  
pieno



 Fig. 66 - 69

1/2

10-160-01-07

13,5 cm / 5 3/8"

für Mikro-Skalpellklingen  
for micro scalpel blades  
para micro-hojas de bisturí  
pour micro-lames de bistouris  
per micro-lame per bisturi

## Skalpellslingen

Scalpel Blades  
 Hojas de bisturí  
 Lames de bistouris  
 Lame per bisturi

einzel verpackt, VE = 100 Stück  
 single packed, SU = 100/pack  
 envase individual, UV = 100 piezas  
 enveloppe individuelle, UC = 100 untiés  
 bustina individuale, UV = 100 pezzi



10-199-00-01

Skalpellslingen-Entferner  
 Scalpel Blade Remover  
 Quita-hojas  
 Enlève-lame  
 Distributore lame

1/1



|                   | Fig. 10      | Fig. 11      | Fig. 12      | Fig. 12 D    | Fig. 15      | Fig. 15 C    |
|-------------------|--------------|--------------|--------------|--------------|--------------|--------------|
| <b>STERILE IR</b> | 10-155-10-04 | 10-155-11-04 | 10-155-12-04 | 10-156-12-04 | 10-155-15-04 | 10-156-15-04 |

1/1



|                   | Fig. 18      | Fig. 20      | Fig. 21      | Fig. 22      | Fig. 23      | Fig. 24      | Fig. 36      |
|-------------------|--------------|--------------|--------------|--------------|--------------|--------------|--------------|
| <b>STERILE IR</b> | 10-155-18-04 | 10-155-20-04 | 10-155-21-04 | 10-155-22-04 | 10-155-23-04 | 10-155-24-04 | 10-155-36-04 |

## Einmalskalpelle

Disposable Scalpels  
Bisturíes desechables  
Bistouris à usage unique  
Bisturi per uso unico

## Skalpelle

Scalpels  
Bisturíes  
Bistouris  
Bisturi



### STERILE | R

steril  
einzeln verpackt  
Packung mit 10 Stück

sterile  
single packed  
package with 10 units

estéril  
envase individual  
paquete con 10 unidades

stérile  
enveloppe individuelle  
boîte de 10 bisturis

sterile  
bustina individuale  
scatola di 10 bisturi



1/1

|             | Fig. 20      | Fig. 21      | Fig. 22      | Fig. 23      | Fig. 24      |
|-------------|--------------|--------------|--------------|--------------|--------------|
| STERILE   R | 10-285-20-04 | 10-285-21-04 | 10-285-22-04 | 10-285-23-04 | 10-285-24-04 |

# Einmalskalpelle

Disposable Scalpels  
Bisturís desechables  
Bistouris à usage unique  
Bisturi per uso unico

## STERILE | R

steril  
einzeln verpackt  
Packung mit 10 Stück

sterile  
single packed  
package with 10 units

estéril  
envase individual  
paquete con 10 unidades

stérile  
enveloppe individuelle  
boîte de 10 bisturis

sterile  
bustina individuale  
scatola di 10 bisturi



1/1

|             | Fig. 10      | Fig. 11      | Fig. 12      | Fig. 15      | Fig. 12 D    | Fig. 15 C    |
|-------------|--------------|--------------|--------------|--------------|--------------|--------------|
| STERILE   R | 10-295-10-04 | 10-295-11-04 | 10-295-12-04 | 10-295-15-04 | 10-296-12-04 | 10-296-15-04 |

Scheren  
Scissors  
Tijeras  
Ciseaux  
Forbici

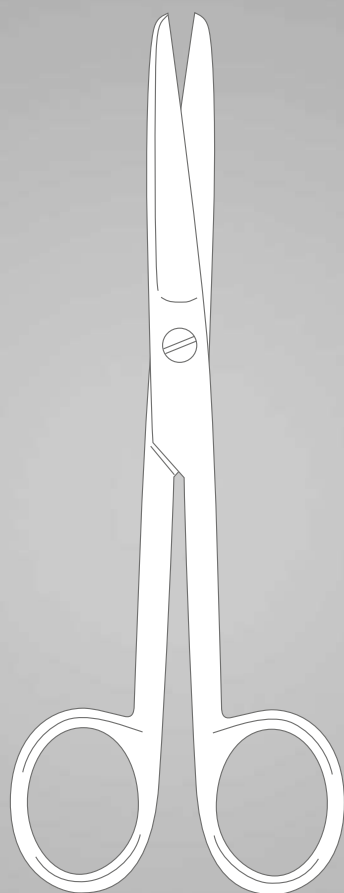

# Chirurgische Scheren

Operating Scissors

Tijeras quirúrgicas

Ciseaux chirurgicaux

Forbici per chirurgia



|                  | Standard     | TCGOLD       |
|------------------|--------------|--------------|
| 12 cm / 4 6/8"   | 11-100-11-07 |              |
| 13 cm / 5 1/8"   | 11-100-13-07 |              |
| 14,5 cm / 5 6/8" | 11-100-14-07 | 11-902-14-07 |
| 16,5 cm / 6 4/8" | 11-100-16-07 |              |
| 18,5 cm / 7 2/8" | 11-100-18-07 |              |
| 20,5 cm / 8 1/8" | 11-100-20-07 |              |

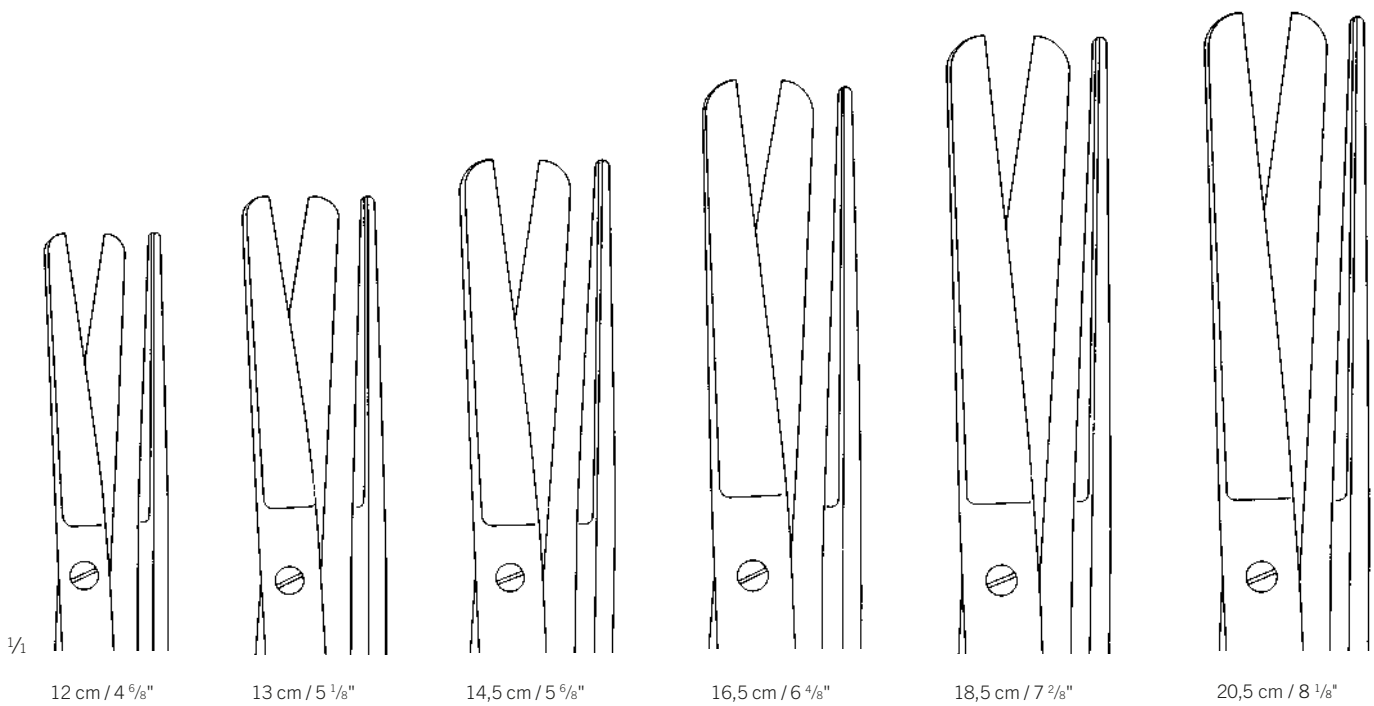

1/2

12 cm / 4 6/8"

13 cm / 5 1/8"

14,5 cm / 5 6/8"

16,5 cm / 6 4/8"

18,5 cm / 7 2/8"

20,5 cm / 8 1/8"

# Chirurgische Scheren

Operating Scissors  
Tijeras quirúrgicas  
Ciseaux chirurgicaux  
Forbici per chirurgia

# Scheren

Scissors  
Tijeras  
Ciseaux  
Forbici



1/2



1/2

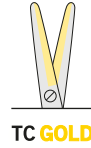

1/2



|                  | Standard     | TCGOLD       | SuperCut     |
|------------------|--------------|--------------|--------------|
| 12 cm / 4 6/8"   | 11-102-11-07 |              |              |
| 13 cm / 5 1/8"   | 11-102-13-07 |              |              |
| 14,5 cm / 5 6/8" | 11-102-14-07 | 11-904-14-07 | 11-650-14-07 |
| 16,5 cm / 6 4/8" | 11-102-16-07 |              |              |
| 18,5 cm / 7 2/8" | 11-102-18-07 |              |              |
| 20,5 cm / 8 1/8" | 11-102-20-07 |              |              |

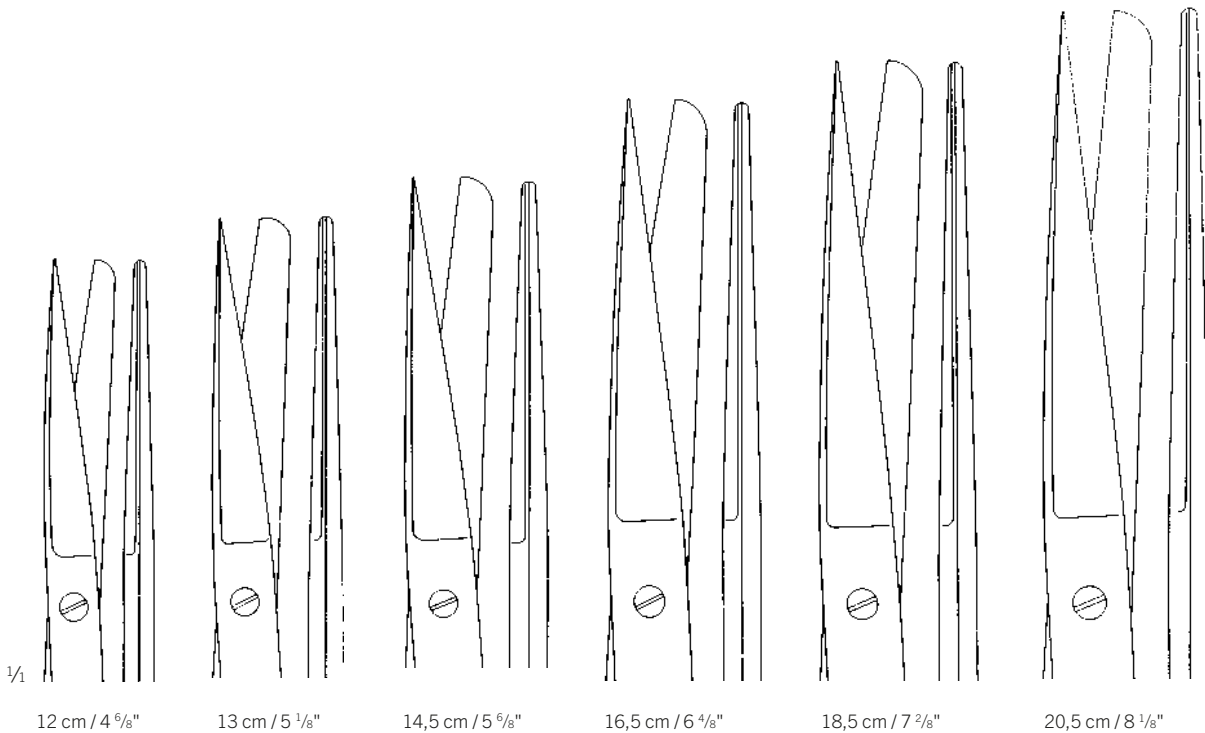

1/1

12 cm / 4 6/8"

13 cm / 5 1/8"

14,5 cm / 5 6/8"

16,5 cm / 6 4/8"

18,5 cm / 7 2/8"

20,5 cm / 8 1/8"

# Chirurgische Scheren

Operating Scissors

Tijeras quirúrgicas

Ciseaux chirurgicaux

Forbici per chirurgia



|                  | Standard     | TCGOLD       |
|------------------|--------------|--------------|
| 12 cm / 4 6/8"   | 11-104-11-07 |              |
| 13 cm / 5 1/8"   | 11-104-13-07 |              |
| 14,5 cm / 5 6/8" | 11-104-14-07 | 11-906-14-07 |
| 16,5 cm / 6 4/8" | 11-104-16-07 |              |

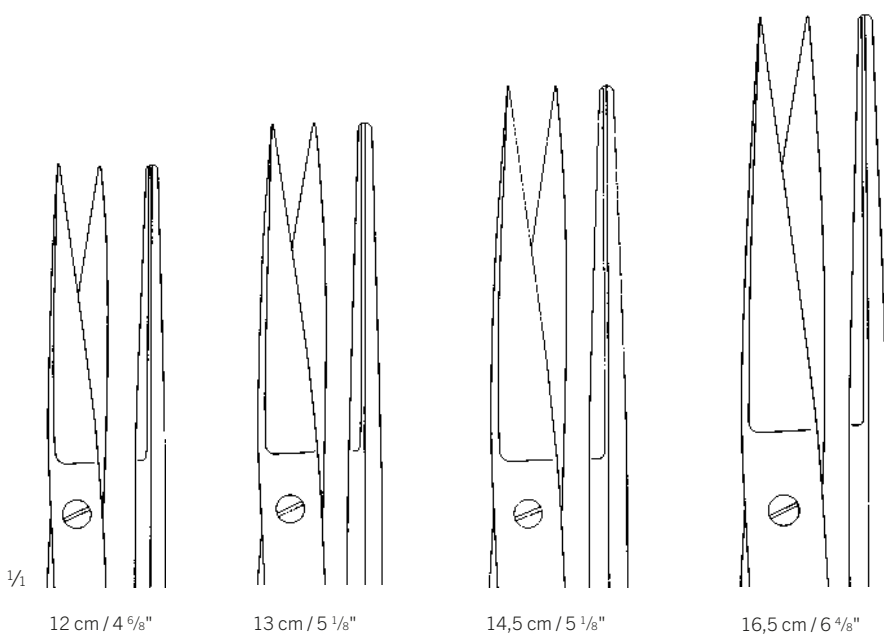

1/1

12 cm / 4 6/8"

13 cm / 5 1/8"

14,5 cm / 5 1/8"

16,5 cm / 6 4/8"



# Chirurgische Scheren

Operating Scissors  
Tijeras quirúrgicas  
Ciseaux chirurgicaux  
Forbici per chirurgia

# Scheren

Scissors  
Tijeras  
Ciseaux  
Forbici



|                  | Standard     | TCGOLD       |
|------------------|--------------|--------------|
| 12 cm / 4 6/8"   | 11-105-11-07 |              |
| 13 cm / 5 1/8"   | 11-105-13-07 |              |
| 14,5 cm / 5 6/8" | 11-105-14-07 | 11-903-14-07 |
| 16,5 cm / 6 4/8" | 11-105-16-07 |              |
| 18,5 cm / 7 2/8" | 11-105-18-07 |              |
| 20,5 cm / 8 1/8" | 11-105-20-07 |              |

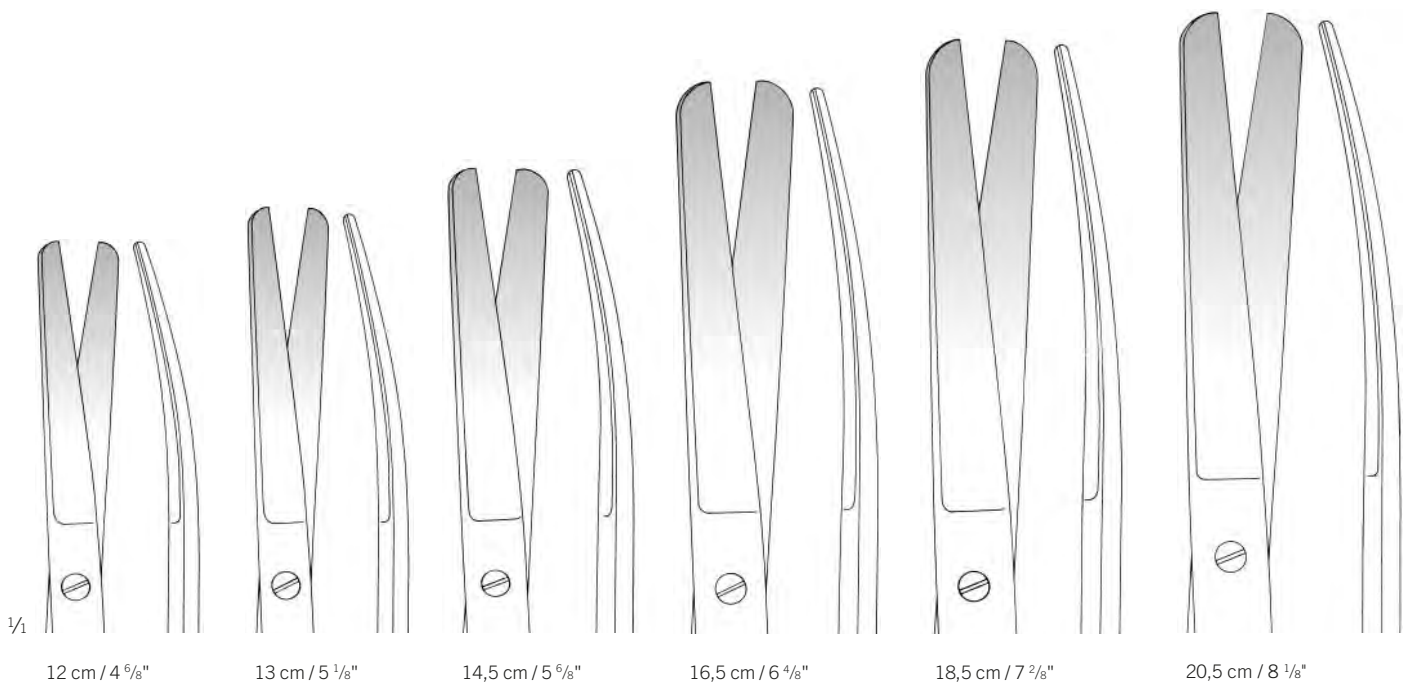

# Chirurgische Scheren

Operating Scissors

Tijeras quirúrgicas

Ciseaux chirurgicaux

Forbici per chirurgia



|                  | Standard     | TCGOLD       | SuperCut     |
|------------------|--------------|--------------|--------------|
| 12 cm / 4 6/8"   | 11-107-11-07 |              |              |
| 13 cm / 5 1/8"   | 11-107-13-07 |              |              |
| 14,5 cm / 5 6/8" | 11-107-14-07 | 11-905-14-07 | 11-651-14-07 |
| 16,5 cm / 6 4/8" | 11-107-16-07 |              |              |
| 18,5 cm / 7 2/8" | 11-107-18-07 |              |              |
| 20,5 cm / 8 1/8" | 11-107-20-07 |              |              |

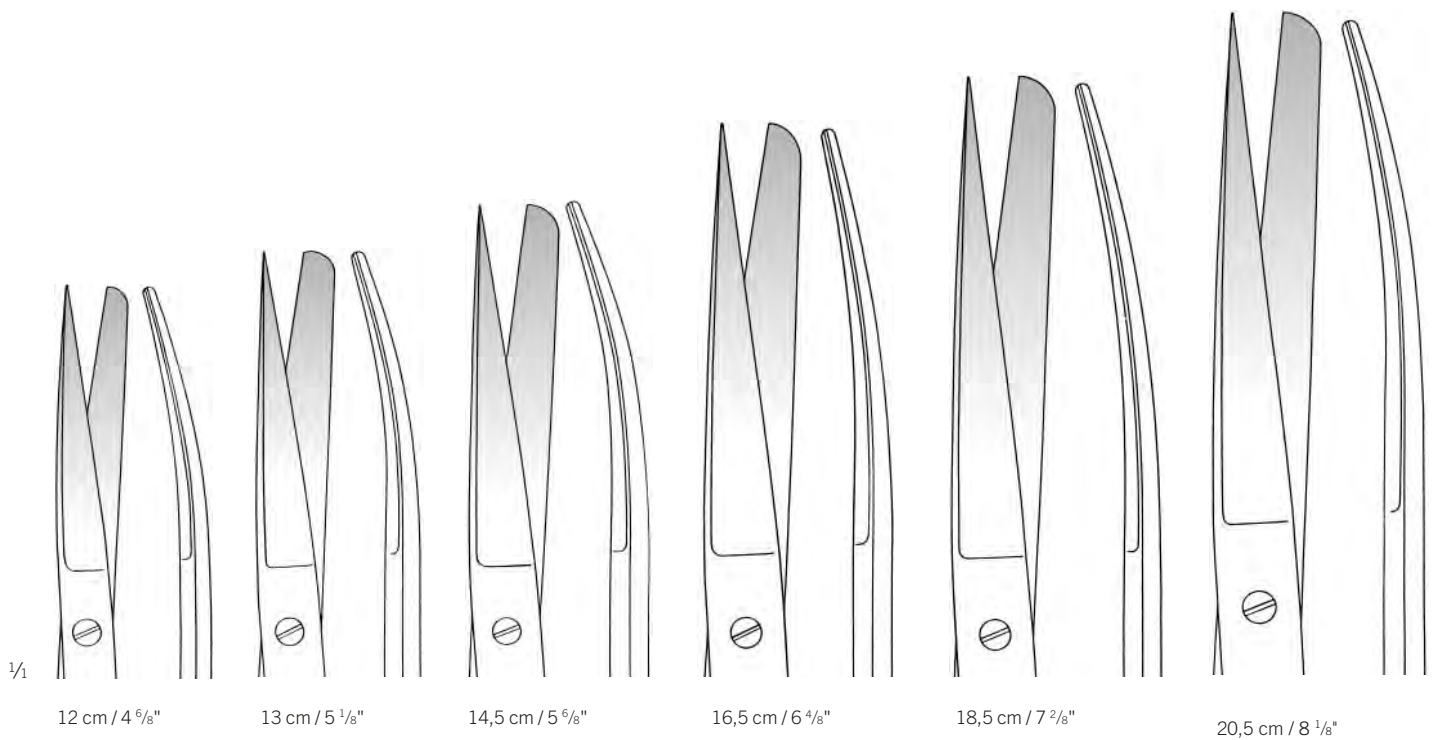

12 cm / 4 6/8"

13 cm / 5 1/8"

14,5 cm / 5 6/8"

16,5 cm / 6 4/8"

18,5 cm / 7 2/8"

20,5 cm / 8 1/8"

## Chirurgische Scheren

Operating Scissors  
Tijeras quirúrgicas  
Ciseaux chirurgicaux  
Forbici per chirurgia

## Scheren

Scissors  
Tijeras  
Ciseaux  
Forbici



|                  | Standard     | TCGOLD       |
|------------------|--------------|--------------|
| 12 cm / 4 6/8"   | 11-109-11-07 |              |
| 13 cm / 5 1/8"   | 11-109-13-07 |              |
| 14,5 cm / 5 6/8" | 11-109-14-07 | 11-907-14-07 |
| 16,5 cm / 6 4/8" | 11-109-16-07 |              |

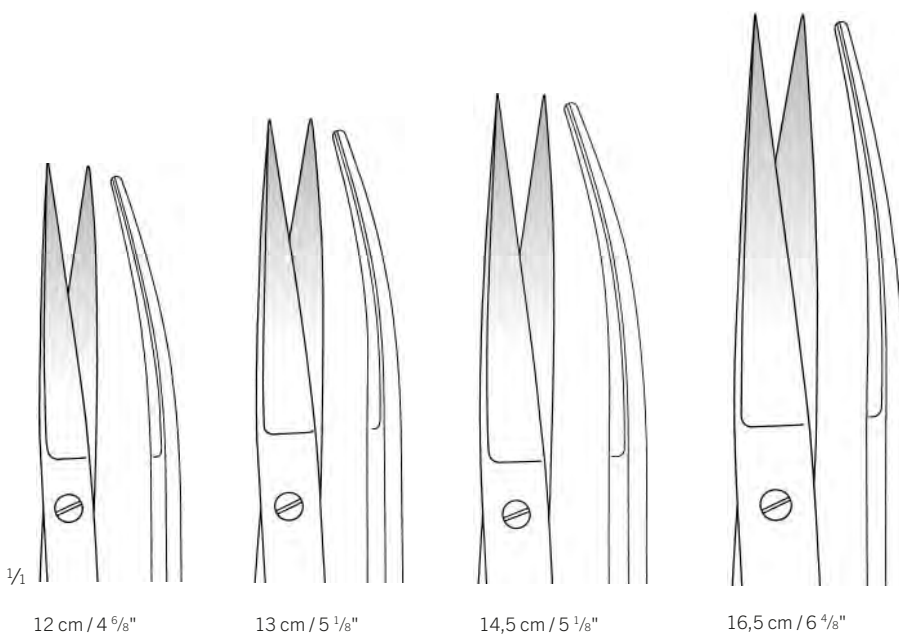

1/2

12 cm / 4 6/8"

13 cm / 5 1/8"

14,5 cm / 5 6/8"

16,5 cm / 6 4/8"

## Chirurgische Scheren

Operating Scissors

Tijeras quirúrgicas

Ciseaux chirurgicaux

Forbici per chirurgia

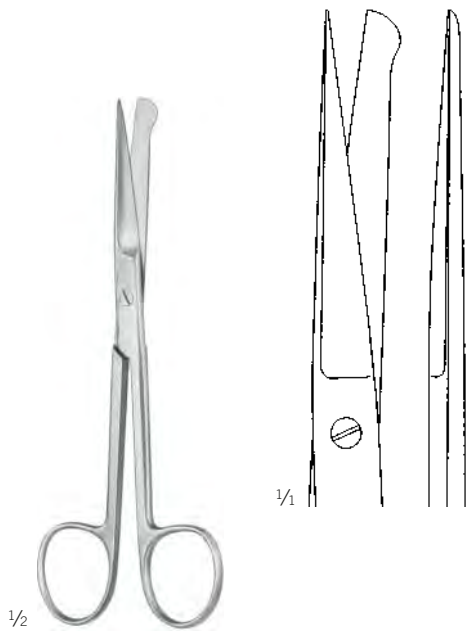

11-136-14-07

14,5 cm / 5 7/8"

Inzisionsschere

Incision Scissors

Tijera para incisiones

Ciseaux à incision

Forbici per incisione

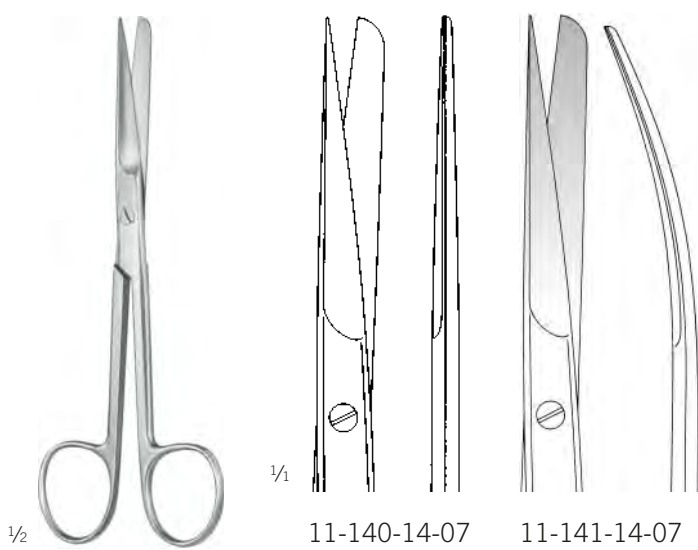

11-140-14-07

11-141-14-07

Deaver

11-140-14-07 -

11-141-14-07

14,5 cm / 5 7/8"

# Präparierscheren

Dissecting Scissors  
Tijeras de disección  
Ciseaux à dissection  
Forbici per dissezione

# Scheren

Scissors  
Tijeras  
Ciseaux  
Forbici



| Mayo             | Standard     | TCGOLD       | SuperCut     | AQUILA       |
|------------------|--------------|--------------|--------------|--------------|
| 14 cm / 5 1/8"   |              |              |              | 28-466-14-07 |
| 14,5 cm / 5 7/8" | 11-170-14-07 | 11-910-14-07 | 11-652-14-07 |              |
| 17 cm / 6 3/8"   | 11-170-17-07 | 11-910-17-07 | 11-652-17-07 | 28-466-17-07 |
| 23 cm / 9"       |              | 11-910-23-07 |              |              |
| 23,5 cm / 9 1/2" | 11-170-23-07 |              | 11-652-23-07 |              |

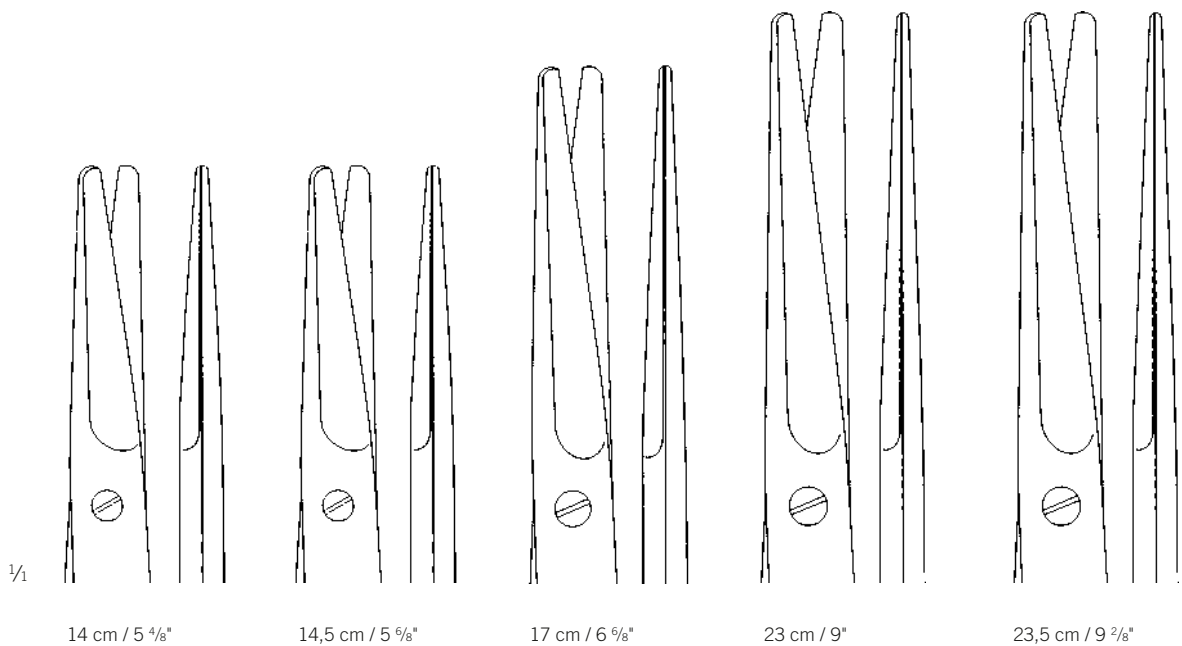

14 cm / 5 1/8"

14,5 cm / 5 7/8"

17 cm / 6 3/8"

23 cm / 9"

23,5 cm / 9 1/2"

# Präparierscheren

Dissecting Scissors  
Tijeras de disección  
Ciseaux à dissection  
Forbici per dissezione



| Mayo             | Standard     | TCGOLD       | SuperCut     | AQUILA       |
|------------------|--------------|--------------|--------------|--------------|
| 14 cm / 5 4/8"   |              |              |              | 28-467-14-07 |
| 14,5 cm / 5 6/8" | 11-171-14-07 | 11-911-14-07 | 11-653-14-07 |              |
| 17 cm / 6 6/8"   | 11-171-17-07 | 11-911-17-07 | 11-653-17-07 | 28-467-17-07 |
| 23 cm / 9"       |              | 11-911-23-07 |              |              |
| 23,5 cm / 9 2/8" | 11-171-23-07 |              | 11-653-23-07 |              |

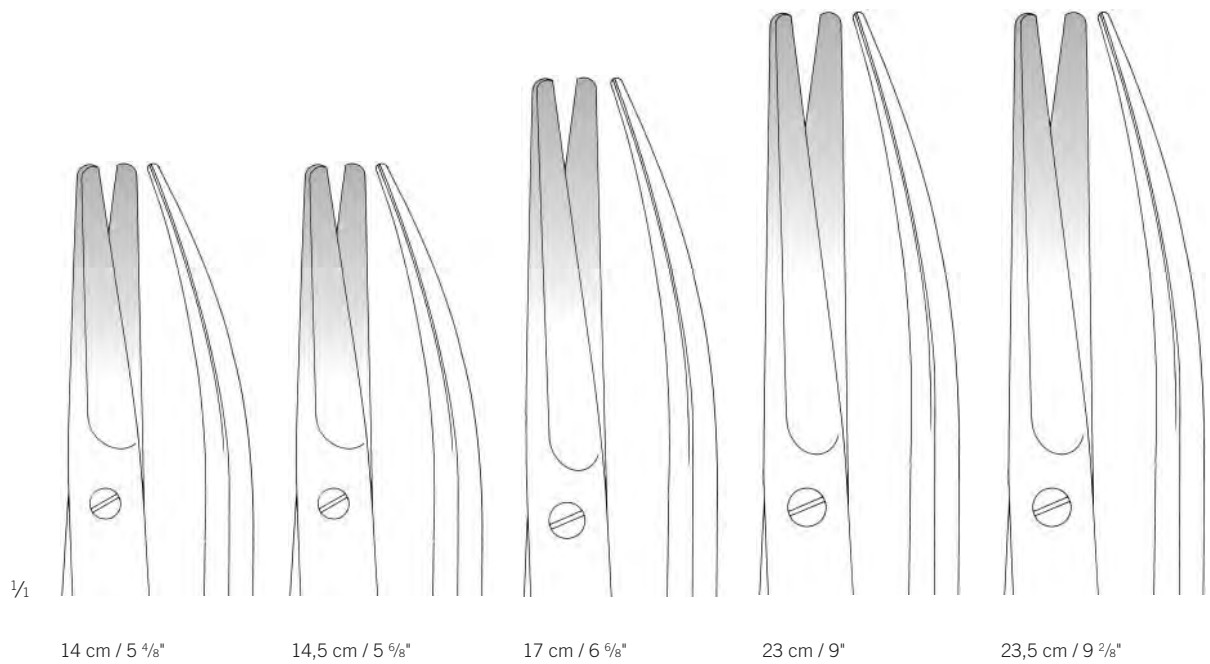

# Präparierscheren

Dissecting Scissors  
Tijeras de disección  
Ciseaux à dissection  
Forbici per dissezione

# Scheren

Scissors  
Tijeras  
Ciseaux  
Forbici



| Mayo-Stille      | Standard     | TCGOLD       | SuperCut     |
|------------------|--------------|--------------|--------------|
| 14,5 cm / 5 7/8" |              | 11-930-15-07 |              |
| 15 cm / 5 7/8"   | 11-180-15-07 |              | 11-654-15-07 |
| 17 cm / 6 5/8"   | 11-180-17-07 | 11-930-17-07 | 11-654-17-07 |
| 19,5 cm / 7 5/8" | 11-184-19-07 |              |              |

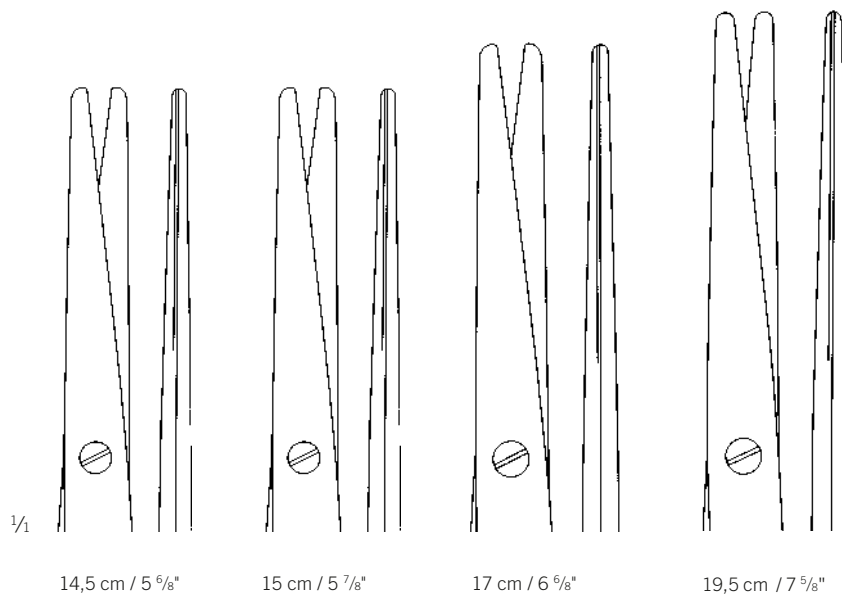

14,5 cm / 5 7/8"

15 cm / 5 7/8"

17 cm / 6 5/8"

19,5 cm / 7 5/8"

# Präparierscheren

Dissecting Scissors  
Tijeras de disección  
Ciseaux à dissection  
Forbici per dissezione



| Mayo-Stille      | Standard     | TCGOLD       | SuperCut     | AQUILA       |
|------------------|--------------|--------------|--------------|--------------|
| 14,5 cm / 5 7/8" |              | 11-931-15-07 |              |              |
| 15 cm / 5 7/8"   | 11-181-15-07 |              | 11-655-15-07 | 28-471-15-07 |
| 17 cm / 6 5/8"   | 11-181-17-07 | 11-931-17-07 | 11-655-17-07 | 28-471-17-07 |
| 19,5 cm / 7 5/8" | 11-185-19-07 |              |              |              |
| 21,5 cm / 8 4/8" | 11-185-21-07 |              |              |              |

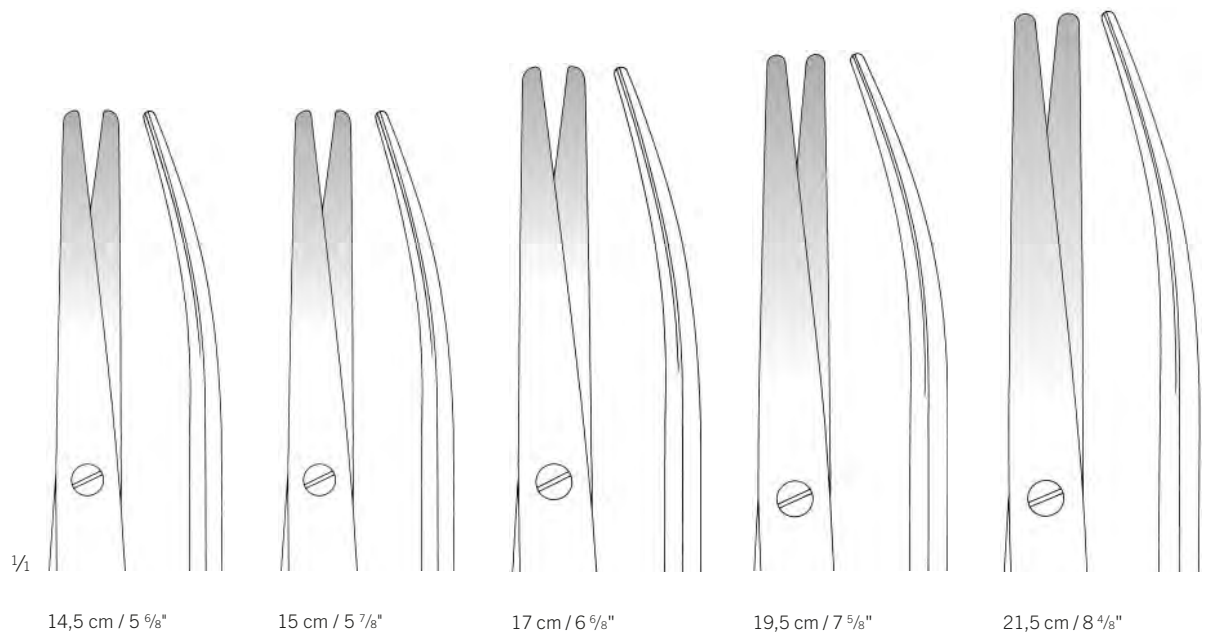

14,5 cm / 5 7/8"

15 cm / 5 7/8"

17 cm / 6 5/8"

19,5 cm / 7 5/8"

21,5 cm / 8 4/8"



## Präparierscheren

Dissecting Scissors  
Tijeras de disección  
Ciseaux à dissection  
Forbici per dissezione

## Scheren

Scissors  
Tijeras  
Ciseaux  
Forbici



1/2

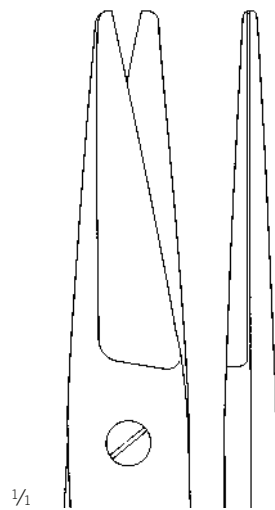

11-190-17-07



11-191-17-07

Mayo-Noble  
11-190-17-07 -  
11-191-17-07  
16,5 cm / 6 4/8"

# Chirurgische Scheren

Operating Scissors

Tijeras quirúrgicas

Ciseaux chirurgicaux

Forbici per chirurgia



| Kelly          | Standard     | TCGOLD       | SuperCut     | AQUILA       |
|----------------|--------------|--------------|--------------|--------------|
| 16 cm / 6 2/8" | 11-226-16-07 | 11-992-16-07 | 11-656-16-07 | 28-474-16-07 |

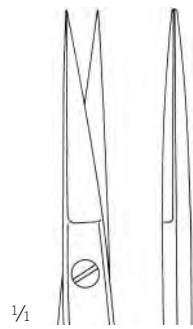

16 cm / 6 2/8"

# Chirurgische Scheren

Operating Scissors  
Tijeras quirúrgicas  
Ciseaux chirurgicaux  
Forbici per chirurgia

# Scheren

Scissors  
Tijeras  
Ciseaux  
Forbici



| Kelly          | Standard     | TCGOLD       | SuperCut     | AQUILA       |
|----------------|--------------|--------------|--------------|--------------|
| 16 cm / 6 2/8" | 11-227-16-07 | 11-993-16-07 | 11-657-16-07 | 28-475-16-07 |

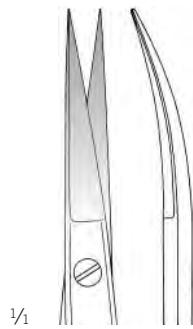

16 cm / 6 2/8"

# Präparierscheren

Dissecting Scissors  
 Tijeras de disección  
 Ciseaux à dissection  
 Forbici per dissezione



| Metzenbaum       | Standard     | TCGOLD       | SuperCut     |
|------------------|--------------|--------------|--------------|
| 11,5 cm / 4 7/8" | 11-248-11-07 | 11-936-11-07 | 11-658-11-07 |
| 14,5 cm / 5 6/8" | 11-250-14-07 | 11-938-14-07 | 11-658-14-07 |

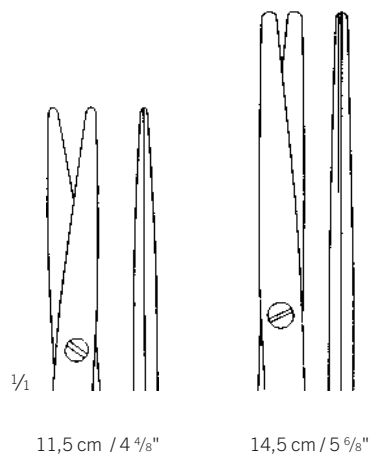

11,5 cm / 4 7/8"

14,5 cm / 5 6/8"

## Präparierscheren

Dissecting Scissors  
Tijeras de disección  
Ciseaux à dissection  
Forbici per dissezione

## Scheren

Scissors  
Tijeras  
Ciseaux  
Forbici



| Metzenbaum       | Standard     | TCGOLD       | SuperCut     | AQUILA       | TCCBlackLine |
|------------------|--------------|--------------|--------------|--------------|--------------|
| 11,5 cm / 4 1/8" | 11-249-11-07 | 11-937-11-07 | 11-659-11-07 |              |              |
| 12 cm / 4 6/8"   |              |              |              | 11-887-11-07 | 11-917-11-07 |
| 14,5 cm / 5 6/8" | 11-255-14-07 | 11-939-14-07 | 11-659-14-07 |              |              |

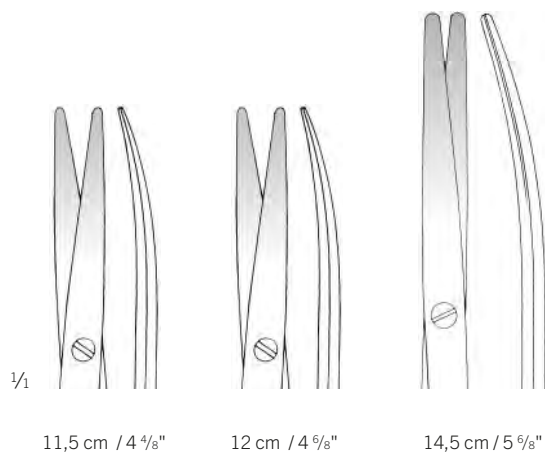

## Präparierscheren

Dissecting Scissors  
Tijeras de disección  
Ciseaux à dissection  
Forbici per dissezione

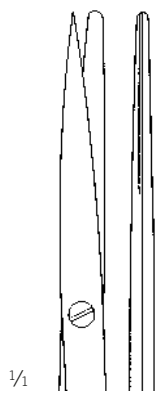

11-252-14-07

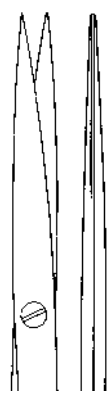

11-254-14-07

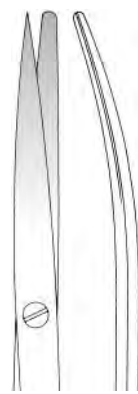

11-257-14-07



11-259-14-07

Metzenbaum  
11-252-14-07 -  
11-259-14-07  
14,5 cm / 5 7/8"

# Präparierscheren

Dissecting Scissors  
Tijeras de disección  
Ciseaux à dissection  
Forbici per dissezione

# Scheren

Scissors  
Tijeras  
Ciseaux  
Forbici



| Metzenbaum        | Standard     | TCGOLD       | SuperCut     | AQUILA       |
|-------------------|--------------|--------------|--------------|--------------|
| 15,5 cm / 6 1/8"  | 11-264-15-07 |              |              |              |
| 18 cm / 7 1/8"    | 11-280-18-07 | 11-942-18-07 | 11-660-18-07 |              |
| 20 cm / 7 7/8"    |              |              |              | 28-472-20-07 |
| 20,5 cm / 8 1/8"  | 11-280-20-07 | 11-942-20-07 | 11-660-20-07 |              |
| 23 cm / 9"        | 11-280-23-07 | 11-942-23-07 | 11-660-23-07 | 28-472-23-07 |
| 26 cm / 10 2/8"   | 11-280-25-07 | 11-942-25-07 | 11-660-26-07 |              |
| 28,5 cm / 11 2/8" | 11-280-28-07 | 11-942-28-07 | 11-660-28-07 |              |
| 31 cm / 12 2/8"   | 11-280-30-07 | 11-942-30-07 | 11-660-31-07 |              |

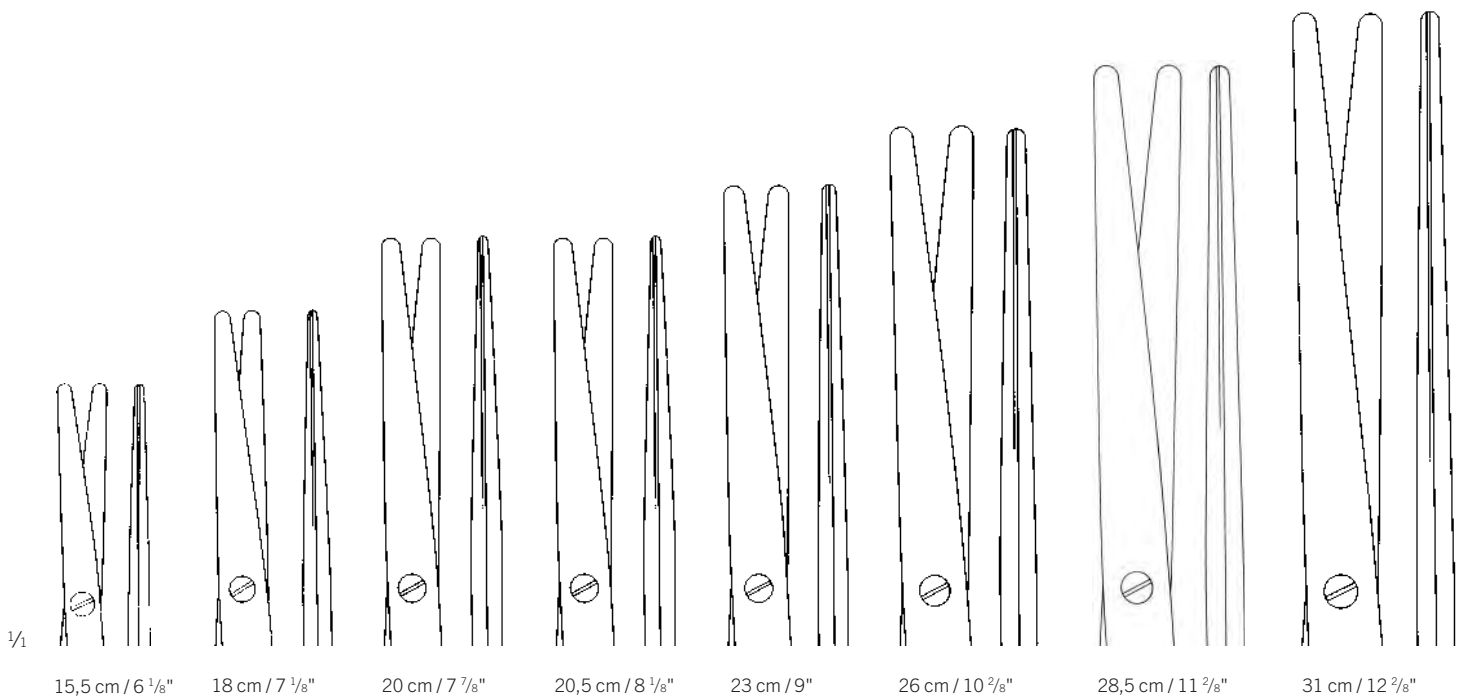

15,5 cm / 6 1/8"    18 cm / 7 1/8"    20 cm / 7 7/8"    20,5 cm / 8 1/8"    23 cm / 9"    26 cm / 10 2/8"    28,5 cm / 11 2/8"    31 cm / 12 2/8"

# Präparierscheren

Dissecting Scissors  
Tijeras de disección  
Ciseaux à dissection  
Forbici per dissezione



| Metzenbaum        | Standard     | TCGOLD       | SuperCut     |
|-------------------|--------------|--------------|--------------|
| 15,5 cm / 6 1/8"  | 11-265-15-07 |              |              |
| 18 cm / 7 1/8"    | 11-285-18-07 | 11-943-18-07 | 11-661-18-07 |
| 20,5 cm / 8 1/8"  | 11-285-20-07 | 11-943-20-07 | 11-661-20-07 |
| 23 cm / 9"        | 11-285-23-07 | 11-943-23-07 | 11-661-23-07 |
| 25 cm / 9 6/8"    |              |              |              |
| 26 cm / 10 2/8"   | 11-285-25-07 | 11-943-25-07 | 11-661-26-07 |
| 28,5 cm / 11 2/8" | 11-285-28-07 | 11-943-28-07 | 11-661-28-07 |
| 30 cm / 11 6/8"   |              | 11-943-30-07 |              |
| 31 cm / 12 2/8"   | 11-285-30-07 |              | 11-661-31-07 |

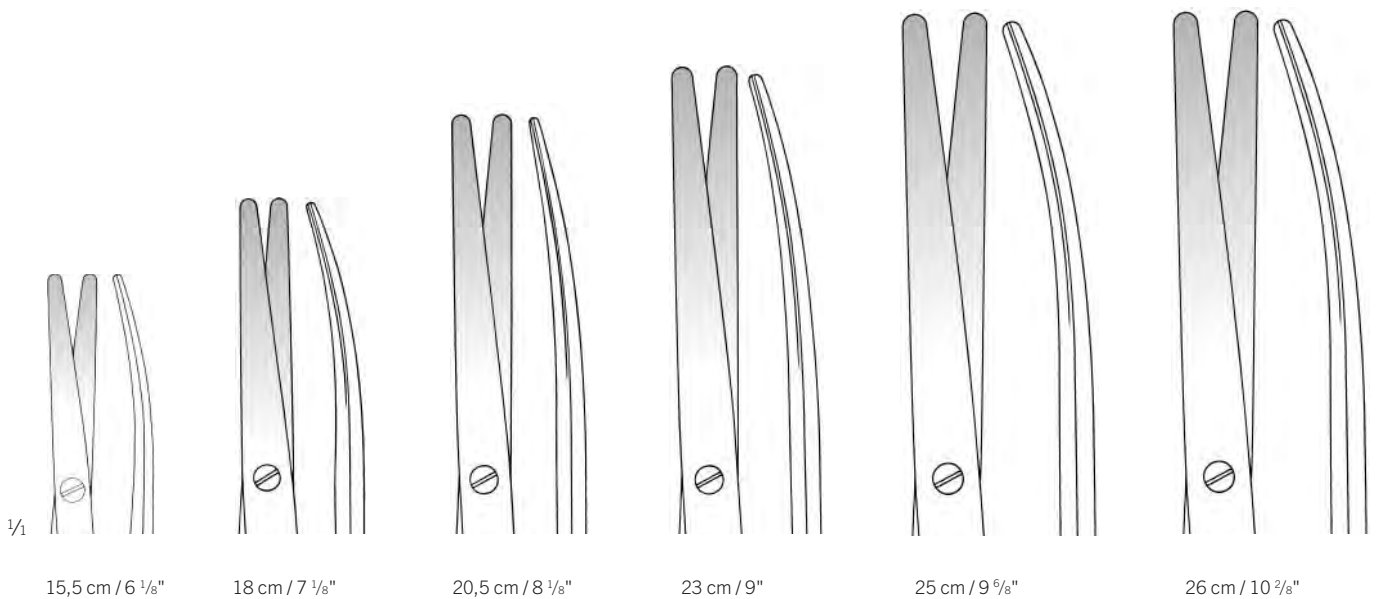

15,5 cm / 6 1/8"

18 cm / 7 1/8"

20,5 cm / 8 1/8"

23 cm / 9"

25 cm / 9 6/8"

26 cm / 10 2/8"



## Präparierscheren

Dissecting Scissors  
Tijeras de disección  
Ciseaux à dissection  
Forbici per dissezione

## Scheren

Scissors  
Tijeras  
Ciseaux  
Forbici



| Metzenbaum        |  AQUILA | TCCBlackLine |
|-------------------|--|--------------|
| 15,5 cm / 6 1/8"  |  |              |
| 18 cm / 7 1/8"    | 11-887-18-07   | 11-917-18-07 |
| 20,5 cm / 8 1/8"  | 11-887-20-07   | 11-917-20-07 |
| 23 cm / 9"        | 11-887-23-07   | 11-917-23-07 |
| 25 cm / 9 6/8"    | 11-887-25-07   | 11-917-25-07 |
| 26 cm / 10 2/8"   |  |              |
| 28,5 cm / 11 2/8" |  |              |
| 30 cm / 11 6/8"   | 11-887-30-07   | 11-917-30-07 |
| 31 cm / 12 2/8"   |  |              |

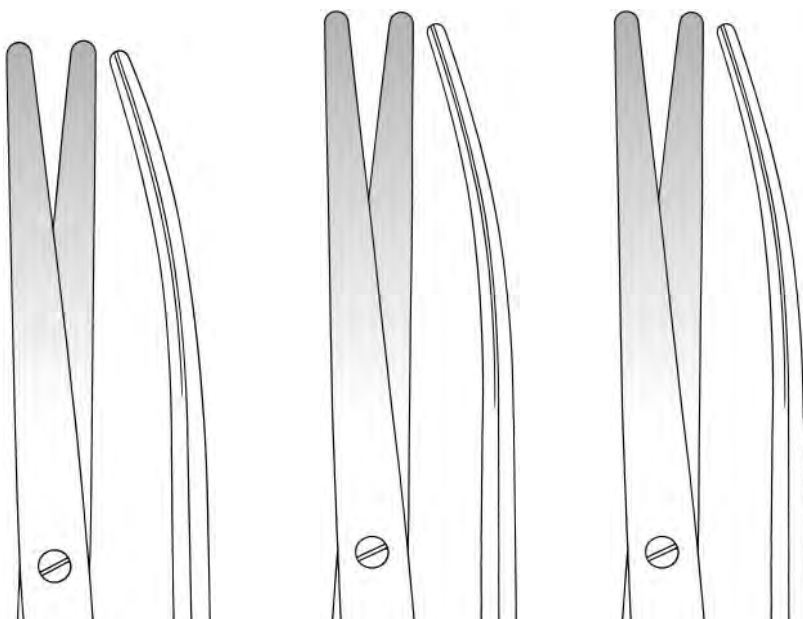

28,5 cm / 11 2/8"

30 cm / 11 6/8"

31 cm / 12 1/8"

## Präparierscheren

Dissecting Scissors  
Tijeras de disección  
Ciseaux à dissection  
Forbici per dissezione



Metzenbaum-Nelson  
11-284-18-07 -  
11-284-20-07



11-284-18-07  
18 cm / 7 1/8"

11-284-20-07  
20,5 cm / 8 1/8"



Metzenbaum  
11-298-14-07-  
11-299-14-07

14,5 cm / 5 7/8"  
eine Schneide gezahnt  
one toothed cutting edge  
una hoja dentada  
une lame dentelée  
una lama dentata

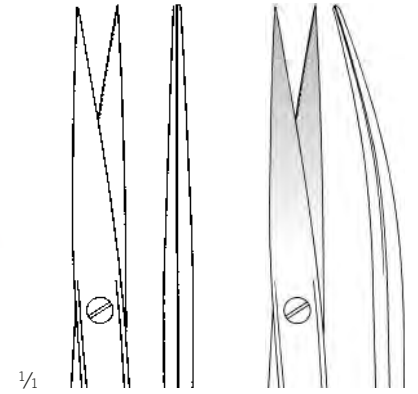

11-298-14-07

11-299-14-07



11-300-15-07 -  
11-301-15-07  
15,5 cm / 6 1/8"

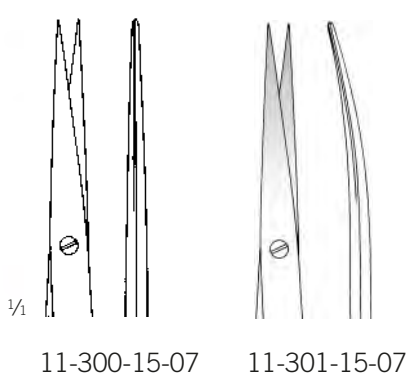

11-300-15-07

11-301-15-07

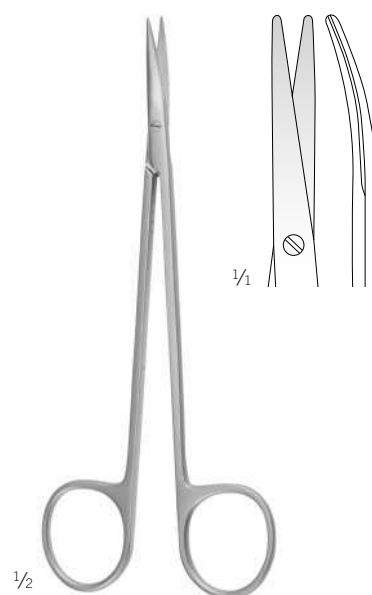

Kübler  
11-302-15-07  
15 cm / 5 7/8"

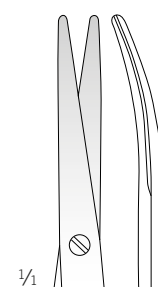

## Präparierscheren

Dissecting Scissors  
Tijeras de disección  
Ciseaux à dissection  
Forbici per dissezione

## Scheren

Scissors  
Tijeras  
Ciseaux  
Forbici



| Lexer          | Standard     | TCGOLD       | SuperCut     | AQUILA       |
|----------------|--------------|--------------|--------------|--------------|
| 16 cm / 6 2/8" | 11-310-16-07 | 11-950-16-07 | 11-662-16-07 | 28-468-16-07 |
| 21 cm / 6 2/8" |              | 11-950-21-07 |              |              |

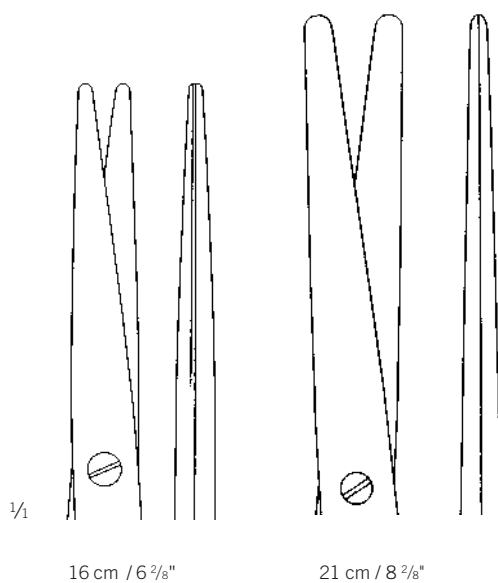

16 cm / 6 2/8"

21 cm / 8 2/8"

## Präparierscheren

Dissecting Scissors  
Tijeras de disección  
Ciseaux à dissection  
Forbici per dissezione



| Lexer          | Standard     | TCGOLD       | SuperCut     | AQUILA       |
|----------------|--------------|--------------|--------------|--------------|
| 16 cm / 6 2/8" | 11-311-16-07 | 11-951-16-07 | 11-663-16-07 | 28-469-16-07 |
| 21 cm / 8 2/8" |              | 11-951-21-07 |              |              |

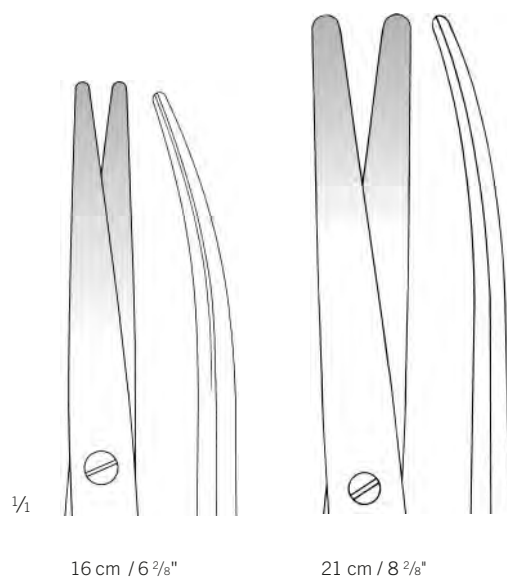

16 cm / 6 2/8"

21 cm / 8 2/8"

## Präparierscheren

Dissecting Scissors  
Tijeras de disección  
Ciseaux à dissection  
Forbici per dissezione

## Scheren

Scissors  
Tijeras  
Ciseaux  
Forbici



| Mayo-Lexer     | AQUILA       | TCCBlackLine |
|----------------|--------------|--------------|
| 16 cm / 6 2/8" | 11-895-16-07 | 11-923-16-07 |

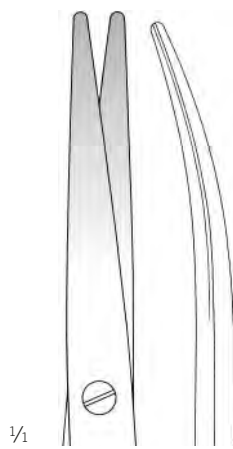

16 cm / 6 2/8"

# Präparierscheren

Dissecting Scissors  
 Tijeras de disección  
 Ciseaux à dissection  
 Forbici per dissezione



| Hohenfellner   | TCGOLD       |
|----------------|--------------|
| 18 cm / 7 1/8" | 11-314-18-07 |
| 21 cm / 8 2/8" | 11-314-21-07 |
| 24 cm / 9 4/8" | 11-314-24-07 |

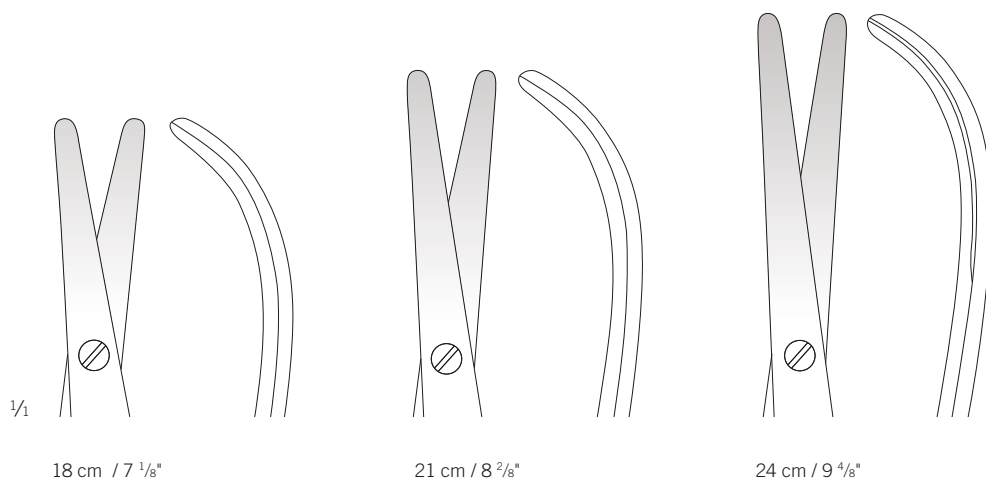

## Präparierscheren

Dissecting Scissors  
Tijeras de disección  
Ciseaux à dissection  
Forbici per dissezione

## Scheren

Scissors  
Tijeras  
Ciseaux  
Forbici

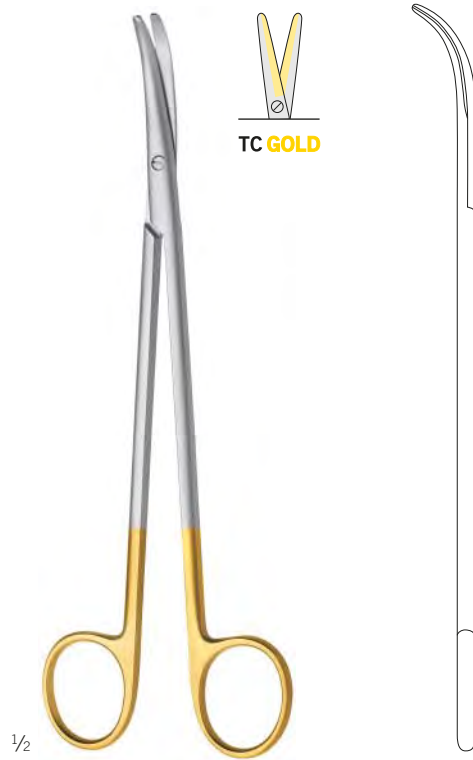

| DeBakey          | TCGOLD       |
|------------------|--------------|
| 17,5 cm / 6 7/8" | 11-316-17-07 |
| 20 cm / 7 7/8"   | 11-316-20-07 |

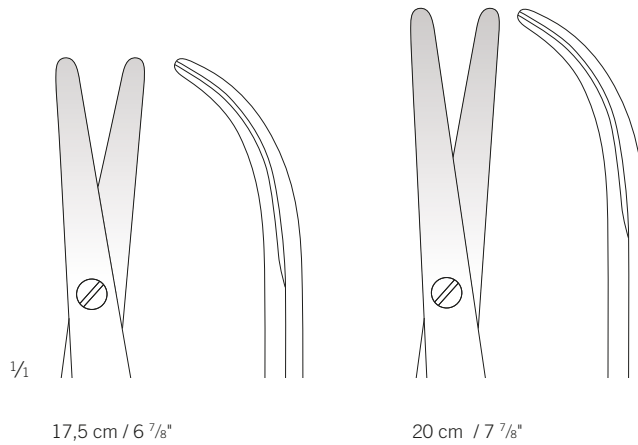

## Präparierscheren

Dissecting Scissors  
Tijeras de disección  
Ciseaux à dissection  
Forbici per dissezione

---

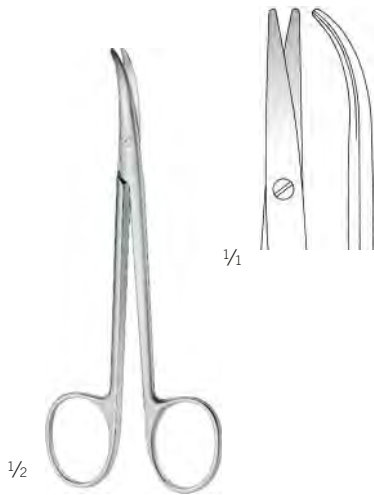

Cinelli  
11-317-11-07  
11,5 cm / 4 5/8"



Fomon  
11-317-14-07  
14 cm / 5 4/8"



## Präparierscheren

Dissecting Scissors  
Tijeras de disección  
Ciseaux à dissection  
Forbici per dissezione

## Scheren

Scissors  
Tijeras  
Ciseaux  
Forbici

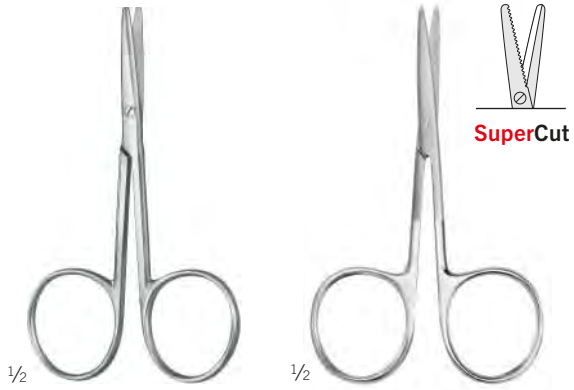

| Lexer-Baby     | Standard     | SuperCut     |
|----------------|--------------|--------------|
| 10 cm / 3 7/8" | 11-320-10-07 | 11-662-10-07 |

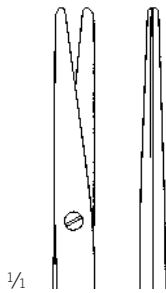

## Präparierscheren

Dissecting Scissors  
Tijeras de disección  
Ciseaux à dissection  
Forbici per dissezione

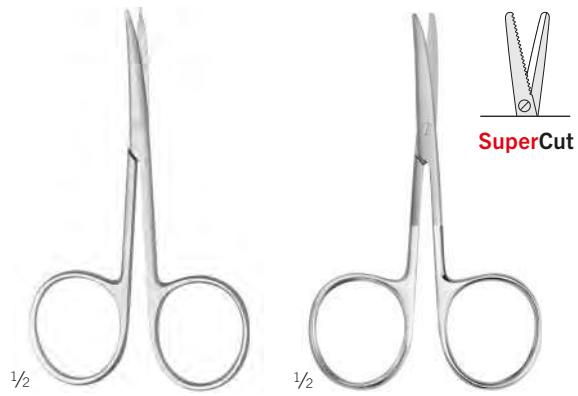

| <b>Lexer-Baby</b> | <b>Standard</b> | <b>SuperCut</b> |
|-------------------|-----------------|-----------------|
| 10 cm / 3 7/8"    | 11-321-10-07    | 11-663-10-07    |

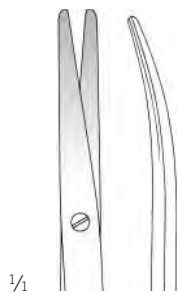

## Präparierscheren

Dissecting Scissors  
Tijeras de disección  
Ciseaux à dissection  
Forbici per dissezione

## Scheren

Scissors  
Tijeras  
Ciseaux  
Forbici



### finoLine

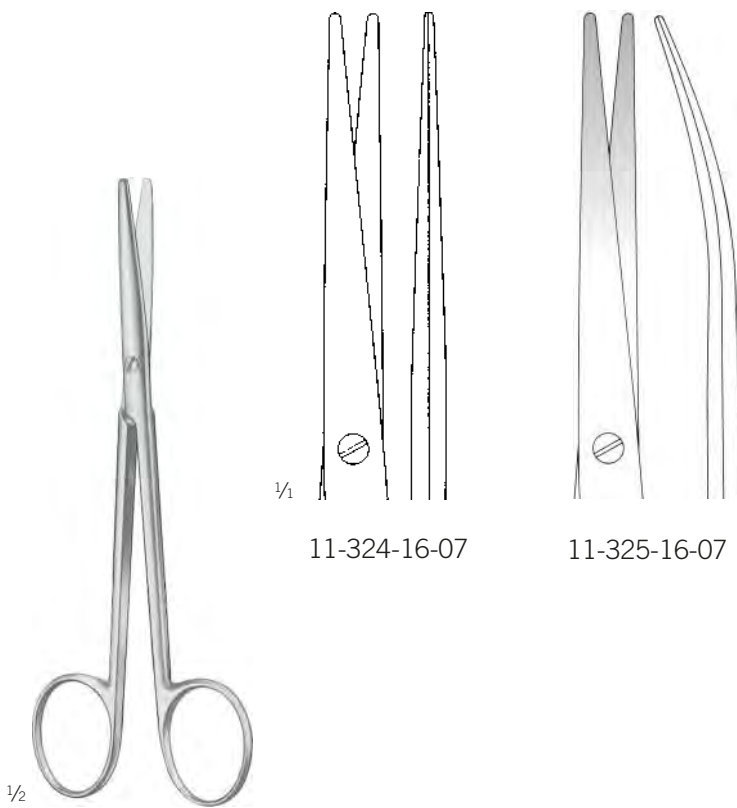

Lexer-Fino  
11-324-16-07 -  
11-325-16-07

16,5 cm / 6 4/8"  
schlankes Modell  
slender pattern  
modelo delgado  
modèle gracile  
modello delicato

## Feine Präparierscheren

Delicate Dissecting Scissors

Tijeras finas de disección

Ciseaux fins à dissection

Forbici fini per dissezione

**finoLine**



| Metzenbaum-Fino  | Standard     | TC GOLD      |
|------------------|--------------|--------------|
| 14,5 cm / 5 7/8" | 11-326-14-07 | 11-954-14-07 |
| 18 cm / 7 1/8"   | 11-330-18-07 | 11-960-18-07 |
| 20 cm / 7 7/8"   | 11-330-20-07 |              |
| 23 cm / 9"       | 11-330-23-07 |              |

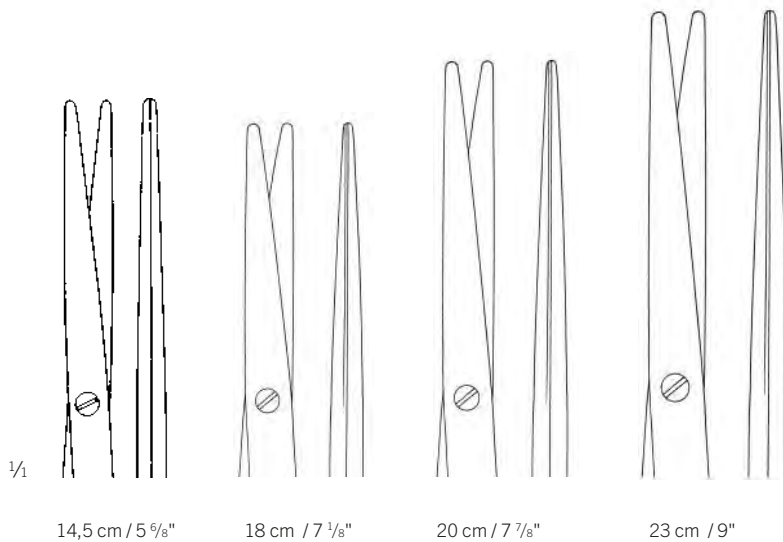

# Feine Präparierscheren

Delicate Dissecting Scissors

Tijeras finas de disección

Ciseaux fins à dissection

Forbici fini per dissezione

# Scheren

Scissors

Tijeras

Ciseaux

Forbici



## finoLine



| Metzenbaum-Fino   | Standard     | TCGOLD       | SuperCut     | AQUILA       |
|-------------------|--------------|--------------|--------------|--------------|
| 14,5 cm / 5 6/8"  | 11-327-14-07 | 11-955-14-07 | 11-665-14-07 | 11-889-14-07 |
| 18 cm / 7 1/8"    | 11-331-18-07 | 11-961-18-07 | 11-665-18-07 | 11-889-18-07 |
| 20,5 cm / 8 1/8"  | 11-331-20-07 | 11-961-20-07 | 11-665-20-07 |              |
| 23 cm / 9"        | 11-331-23-07 | 11-961-23-07 | 11-665-23-07 |              |
| 26 cm / 10 2/8"   |              | 11-961-25-07 |              |              |
| 28,5 cm / 11 2/8" |              | 11-961-28-07 |              |              |

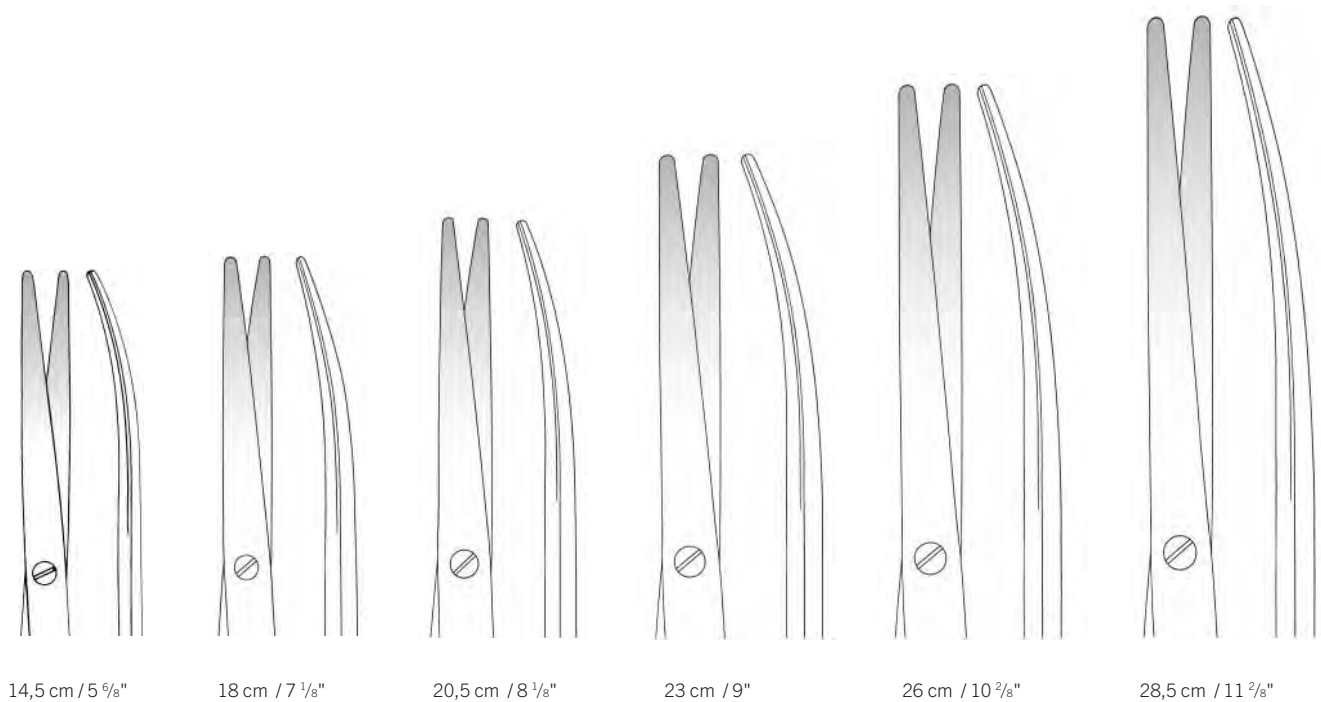

14,5 cm / 5 6/8"

18 cm / 7 1/8"

20,5 cm / 8 1/8"

23 cm / 9"

26 cm / 10 2/8"

28,5 cm / 11 2/8"

## Feine Präparierscheren

Delicate Dissecting Scissors

Tijeras finas de disección

Ciseaux fins à dissection

Forbici fini per dissezione

**finoLine**



| Metzenbaum-Fino  | Standard     | TC <b>GOLD</b> |
|------------------|--------------|----------------|
| 14,5 cm / 5 7/8" | 11-328-14-07 | 11-956-14-07   |
| 18 cm / 7 1/8"   |              | 11-962-18-07   |
| 20 cm / 7 7/8"   |              | 11-962-20-07   |
| 23 cm / 9"       |              | 11-962-23-07   |

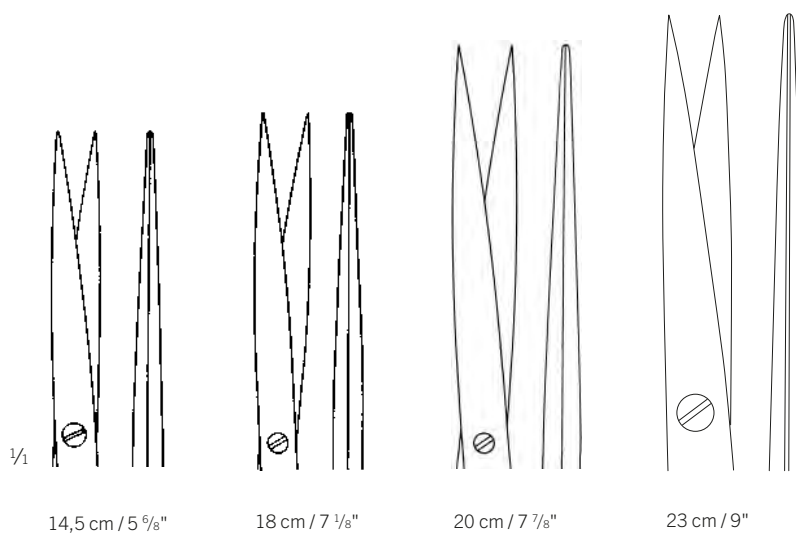

## Feine Präparierscheren

Delicate Dissecting Scissors

Tijeras finas de disección

Ciseaux fins à dissection

Forbici fini per dissezione

## Scheren

Scissors

Tijeras

Ciseaux

Forbici



## finoLine



| Metzenbaum-Fino                           | Standard     | TCGOLD       |
|---|--------------|--------------|
| 14,5 cm / 5 <sup>6</sup> / <sub>8</sub> " | 11-329-14-07 | 11-957-14-07 |
| 18 cm / 7 <sup>1</sup> / <sub>8</sub> "   | 11-329-18-07 |              |
| 20 cm / 7 <sup>7</sup> / <sub>8</sub> "   | 11-329-20-07 |              |

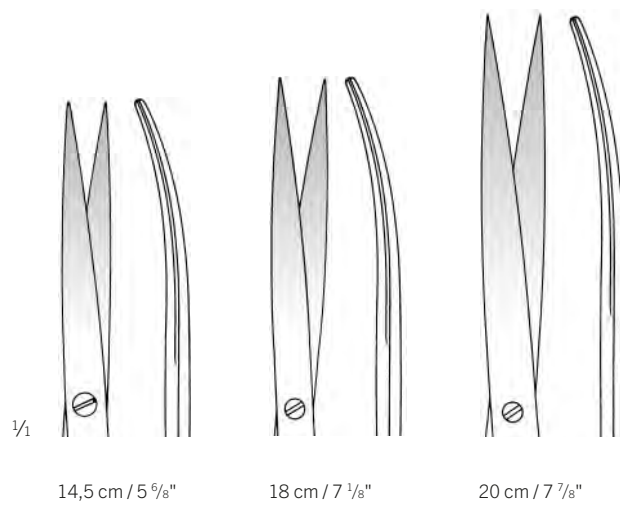

14,5 cm / 5 <sup>6</sup>/<sub>8</sub>"

18 cm / 7 <sup>1</sup>/<sub>8</sub>"

20 cm / 7 <sup>7</sup>/<sub>8</sub>"

# Feine Präparierscheren

Delicate Dissecting Scissors

Tijeras finas de disección

Ciseaux fins à dissection

Forbici fini per dissezione

**finoLine**



| Metzenbaum-Fino  | Standard     | TCGOLD       | AQUILA       |
|------------------|--------------|--------------|--------------|
| 18 cm / 7 1/8"   | 11-335-18-07 | 11-967-18-07 | 28-473-18-07 |
| 20 cm / 7 7/8"   |              |              | 28-473-20-07 |
| 20,5 cm / 8 1/8" | 11-335-20-07 | 11-967-20-07 |              |
| 23 cm / 9"       | 11-335-23-07 | 11-967-23-07 | 28-473-23-07 |

schlankes Modell, S-Form  
slender pattern, S-shaped  
modelo delgado, forma S  
modèle gracile, courbé en S  
modello delicato,  
curvo in forma S

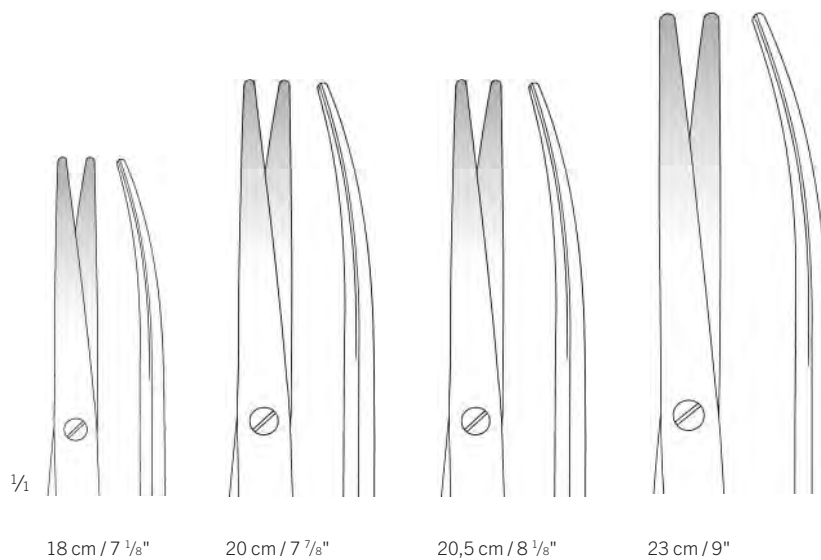

18 cm / 7 1/8"

20 cm / 7 7/8"

20,5 cm / 8 1/8"

23 cm / 9"



# Chirurgische Scheren

Operating Scissors  
Tijeras quirúrgicas  
Ciseaux chirurgicaux  
Forbici per chirurgia

# Scheren

Scissors  
Tijeras  
Ciseaux  
Forbici

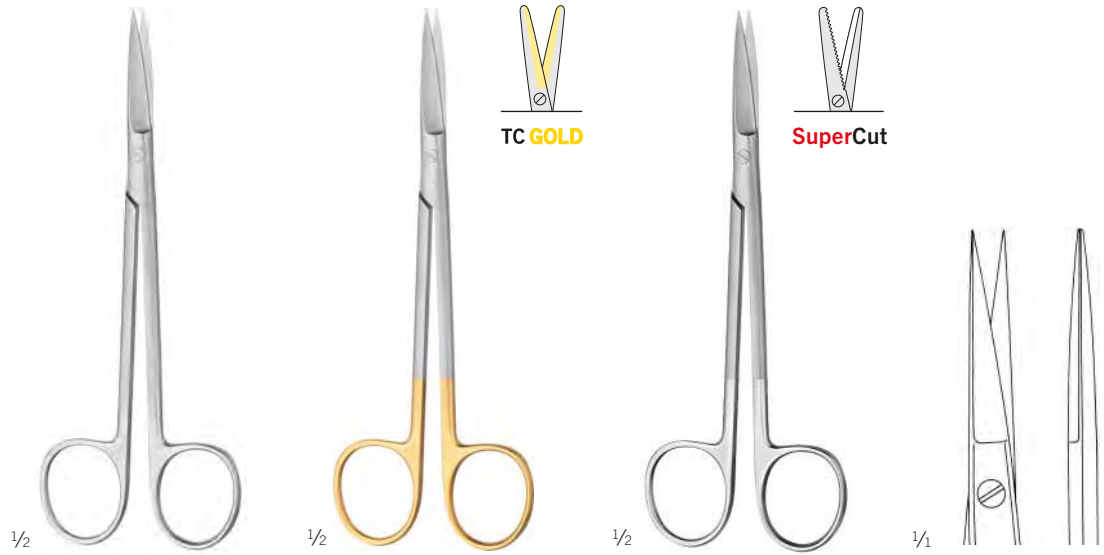

| Joseph           | Standard     | TCGOLD       | SuperCut     |
|------------------|--------------|--------------|--------------|
| 14,5 cm / 5 7/8" | 11-350-14-07 | 11-948-14-07 | 11-666-14-07 |

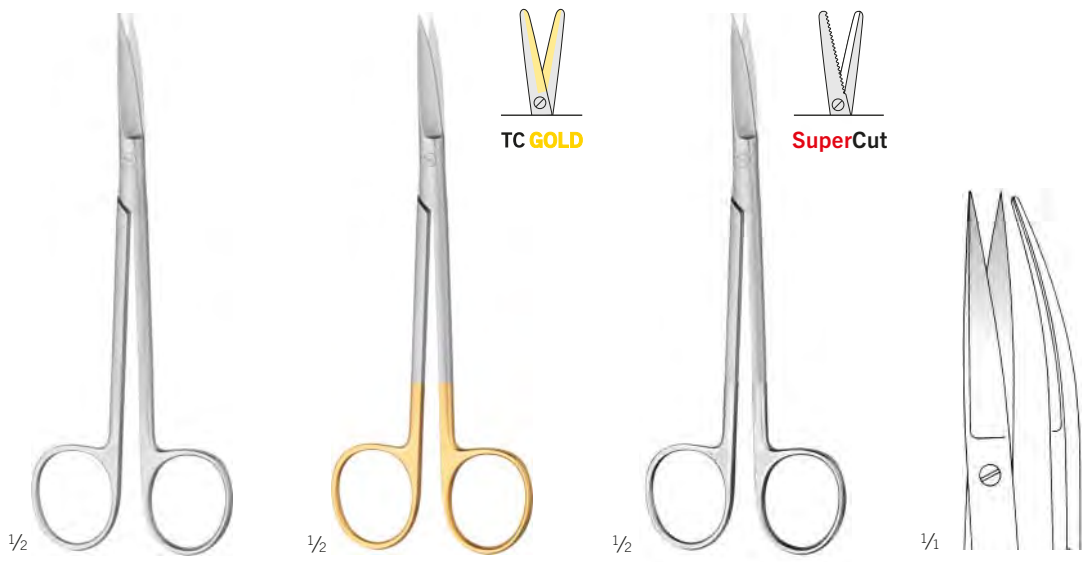

| Joseph           | Standard     | TCGOLD       | SuperCut     |
|------------------|--------------|--------------|--------------|
| 14,5 cm / 5 7/8" | 11-351-14-07 | 11-949-14-07 | 11-667-14-07 |

## Dissektions- u. Zahnfleischschere

Dissecting Scissors  
Tijera de disección  
Ciseaux à dissection  
Forbici per dissezione

---



11-358-13-07

13 cm / 5 1/8"

Dissektions- u. Zahnfleischschere  
Dissecting Scissors  
Tijera de disección  
Ciseaux à dissection  
Forbici per dissezione

## Präparierscheren, Gefäßscheren

Dissecting Scissors, Vascular Scissors

Tijeras de disección, Tijeras vasculares

Ciseaux à dissection, Ciseaux vasculaires

Forbici per dissezione, Forbici vascolari

## Scheren

Scissors

Tijeras

Ciseaux

Forbici



| Reynolds         | Standard     |
|------------------|--------------|
| 14 cm / 5 4/8"   | 11-364-14-07 |
| 15,5 cm / 6 1/8" | 11-364-15-07 |
| 18 cm / 7 1/8"   | 11-364-18-07 |



14 cm / 5 4/8"

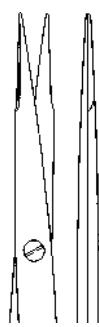

15,5 cm / 6 1/8"



18 cm / 7 1/8"

## Präparierscheren, Gefäßscheren

Dissecting Scissors, Vascular Scissors

Tijeras de disección, Tijeras vasculares

Ciseaux à dissection, Ciseaux vasculaires

Forbici per dissezione, Forbici vascolari

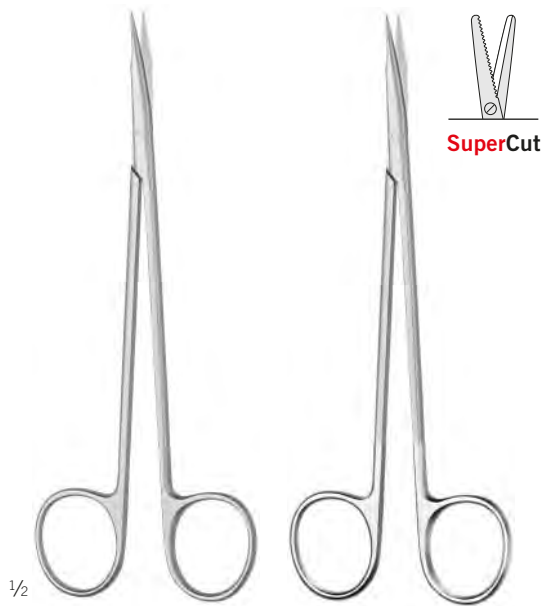

| Reynolds         | Standard     | SuperCut     |
|------------------|--------------|--------------|
| 14 cm / 5 5/8"   | 11-365-14-07 |              |
| 15,5 cm / 6 1/8" | 11-365-15-07 | 11-671-15-07 |
| 18 cm / 7 1/8"   | 11-365-18-07 | 11-671-18-07 |

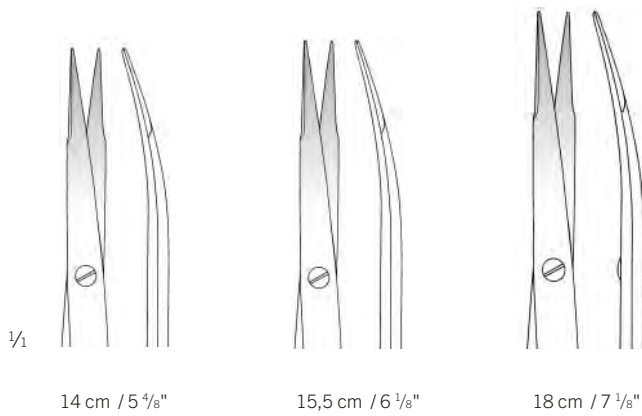

## Präparierscheren, Gefäßscheren

Dissecting Scissors, Vascular Scissors

Tijeras de disección, Tijeras vasculares

Ciseaux à dissection, Ciseaux vasculaires

Forbici per dissezione, Forbici vascolari

## Scheren

Scissors

Tijeras

Ciseaux

Forbici

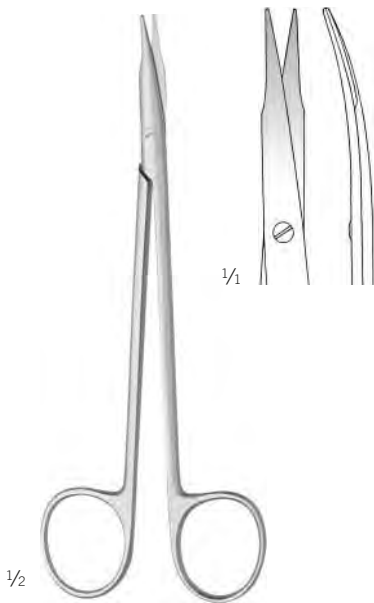

Jameson  
11-367-14-07  
15,5 cm / 6 1/8"

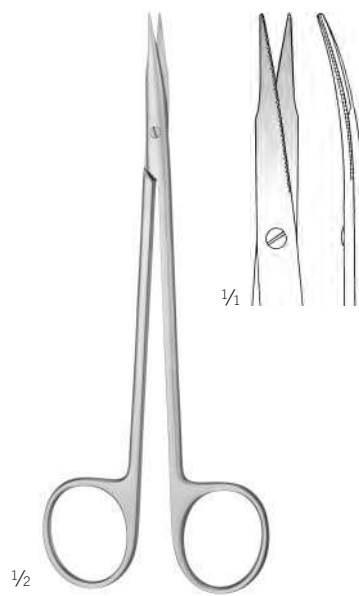

Jameson  
11-369-14-07  
15,5 cm / 6 1/8"

eine Schneide gezahnt  
one toothed cutting edge  
una hoja dentada  
une lame dentelée  
una lama dentata

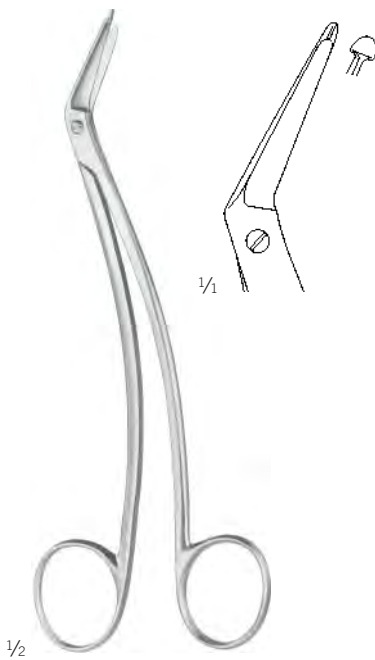

**40°**  
Schmieden-Taylor  
11-455-17-07  
16,5 cm / 6 4/8"

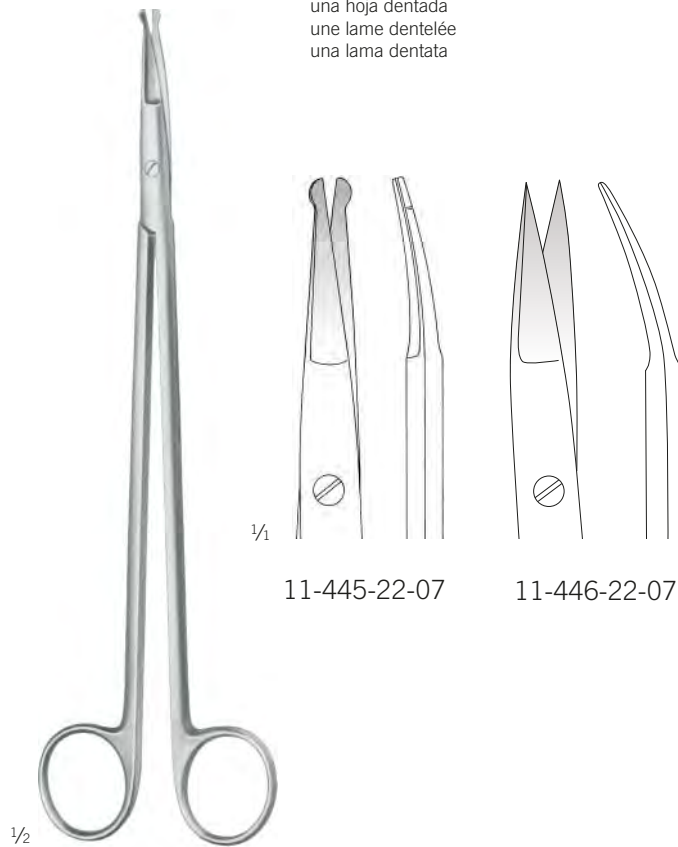

11-445-22-07

11-446-22-07

Strully  
11-445-22-07 - 11-446-22-07  
22 cm / 8 5/8"

Neurochirurgische Schere  
Neurosurgical scissors  
Tijeras para neurocirugía  
Ciseaux pour neurochirurgie  
Forbici per neurochirurgia

## Feine Präparierscheren

Delicate Dissecting Scissors

Tijeras finas de disección

Ciseaux fins à dissection

Forbici fini per dissezione

### finoLine



| Toennis-Adson                             | Standard     | TC <b>GOLD</b> |  <b>AQUILA</b> | <b>TCCBlackLine</b> |
|---|--------------|----------------|---|---------------------|
| 17 cm / 6 <sup>5</sup> / <sub>8</sub> "   |              |                |   | 11-921-17-07        |
| 17,5 cm / 6 <sup>7</sup> / <sub>8</sub> " | 11-459-17-07 | 11-965-17-07   | 11-893-17-07  |                     |
| 18 cm / 7 <sup>1</sup> / <sub>8</sub> "   |              |                | 28-477-18-07  |                     |

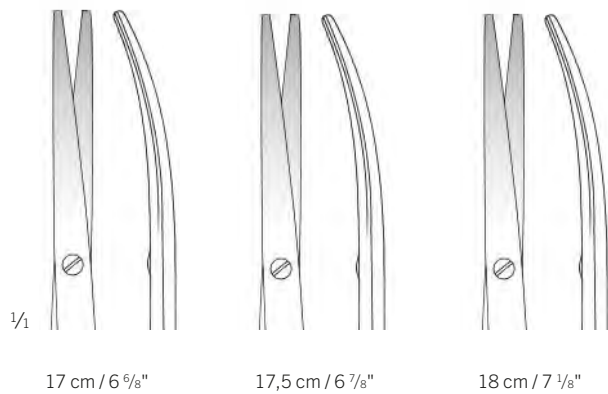

## Präparierscheren

Dissecting Scissors  
Tijeras de disección  
Ciseaux à dissection  
Forbici per dissezione

## Scheren

Scissors  
Tijeras  
Ciseaux  
Forbici



Arbeitslänge  
working length  
largo útil  
longueur utile  
lunghezza utile  
**120 mm**

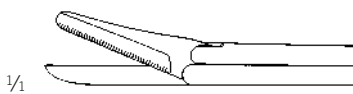

1/2

Olivecrona  
11-475-23-07  
13 cm / 5 1/8"

Trigeminusschere  
Trigeminal scissors  
Tijeras para nervio trigémino  
Ciseaux pour le nerf trigéminal  
Forbici per il nervo trigemino  
eine Schneide gezahnt  
one toothed cutting edge  
una hoja dentada  
une lame dentelée  
una lama dentata

## Chirurgische Scheren

Operating Scissors

Tijeras quirúrgicas

Ciseaux chirurgicaux

Forbici per chirurgia

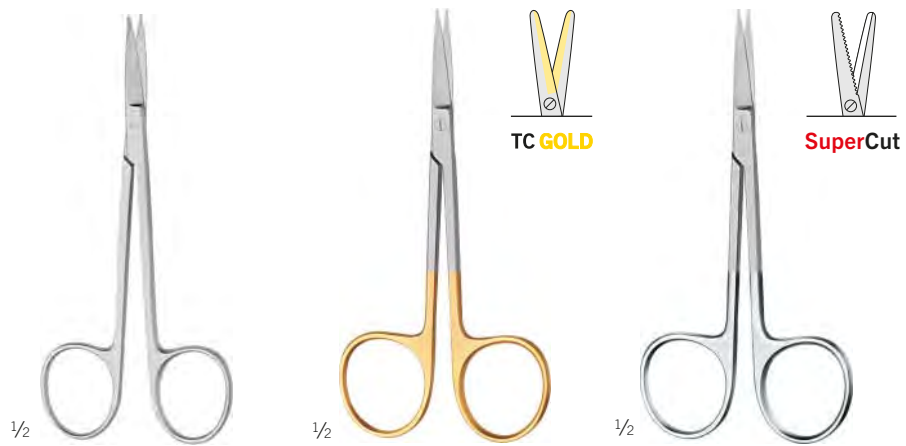

|                  | <b>Standard</b> | <b>TCGOLD</b> | <b>SuperCut</b> |
|------------------|-----------------|---------------|-----------------|
| 11,5 cm / 4 5/8" | 11-630-11-07    | 11-982-11-07  | 11-672-11-07    |





## Chirurgische Scheren

Operating Scissors  
Tijeras quirúrgicas  
Ciseaux chirurgicaux  
Forbici per chirurgia

## Scheren

Scissors  
Tijeras  
Ciseaux  
Forbici



|                  | Standard     | TCGOLD       | SuperCut     |
|------------------|--------------|--------------|--------------|
| 11,5 cm / 4 5/8" | 11-631-11-07 | 11-983-11-07 | 11-673-11-07 |

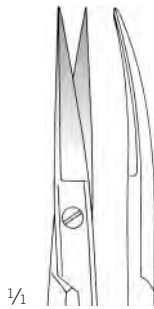

# Irisscheren

Iris Scissors

Tijeras para iridectomía

Ciseaux à iridectomie

Forbici per iridectomia

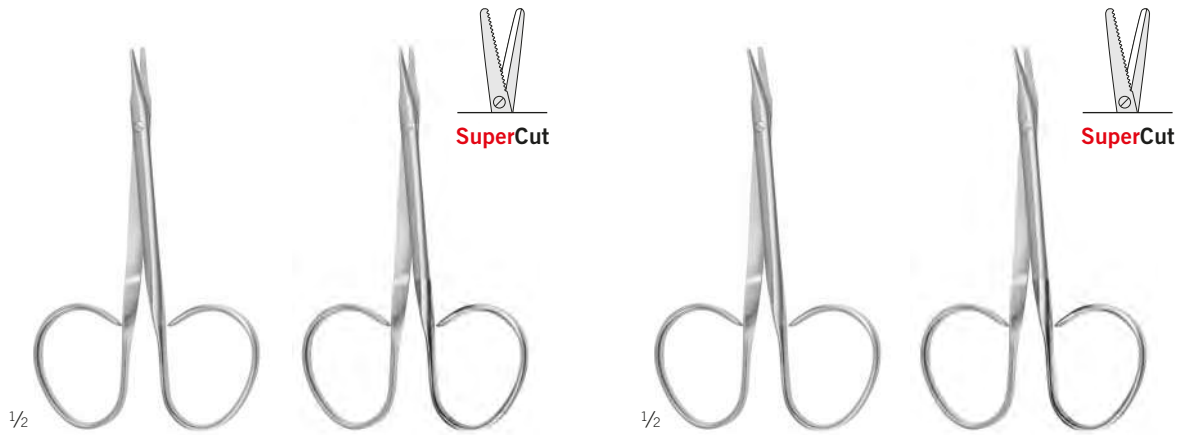

| Stevens          | Standard     | SuperCut     |
|------------------|--------------|--------------|
| 10 cm / 3 7/8"   | 11-678-10-07 |              |
| 10,5 cm / 4 1/8" |              | 11-676-10-07 |
| 11 cm / 4 3/8"   | 11-682-11-07 |              |

| Standard     | SuperCut     |
|--------------|--------------|
| 11-679-10-07 |              |
|              | 11-677-10-07 |
| 11-683-11-07 |              |

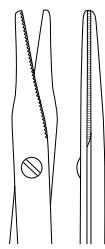
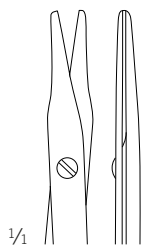

1/1

stumpf/stumpf  
blunt/blunt  
romo/romo  
mousse/mousse  
smusso/smusso

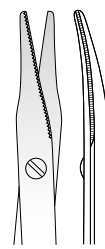
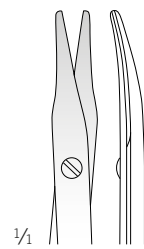

1/1

stumpf/stumpf  
blunt/blunt  
romo/romo  
mousse/mousse  
smusso/smusso

## Irisscheren

Iris Scissors  
Tijeras para iridectomía  
Ciseaux à iridectomie  
Forbici per iridectomia

## Scheren

Scissors  
Tijeras  
Ciseaux  
Forbici

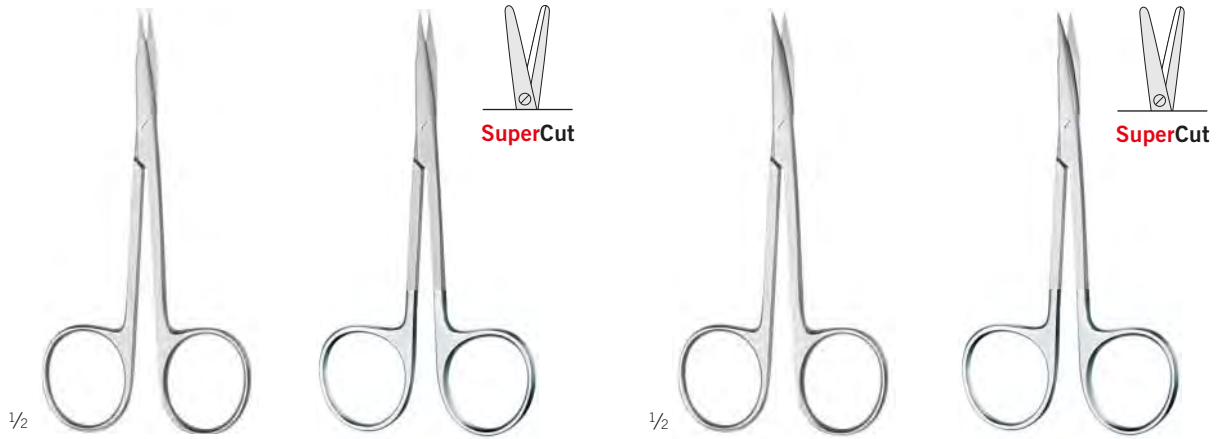

| Stevens          | Standard     | SuperCut     |
|------------------|--------------|--------------|
| 10,5 cm / 4 1/8" |              | 11-674-10-07 |
| 11 cm / 4 3/8"   | 11-680-11-07 |              |

| Standard     | SuperCut     |
|--------------|--------------|
|              | 11-675-10-07 |
| 11-681-11-07 |              |

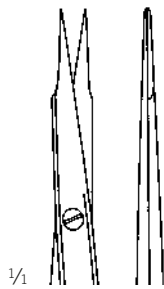

1/1

spitz/spitz  
sharp/sharp  
agudo/agudo  
pointu/pointu  
appuntato/appuntato

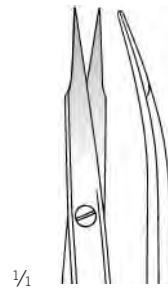

1/1

spitz/spitz  
sharp/sharp  
agudo/agudo  
pointu/pointu  
appuntato/appuntato

## Drahtscheren

Wire Cutting Scissors

Tijeras para cortar hilos de acero

Ciseaux coupe-fil

Forbici per tagliare fili metallici



1/2

Universal  
11-865-12-07



1/2

Universal  
11-995-12-07

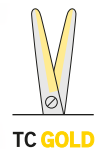

TC GOLD

|                  | Standard  | TCGOLD  |
|------------------|---|---|
| 12 cm / 4 5/8"   | 11-865-12-07  |   |
| 12,5 cm / 4 7/8" |   | 11-995-12-07  |
|                  | max Ø = 0,4 mm<br>weicher Draht<br>soft wire<br>alambre blando<br>fil métallique souple<br>filo morbido | max Ø = 1,0 mm      max Ø = 0,5 mm<br>weicher Draht      harter Draht<br>soft wire              hard wire<br>alambre blando      alambre duro<br>fil métallique souple      fil métallique raide<br>filo morbido              filo rigido |

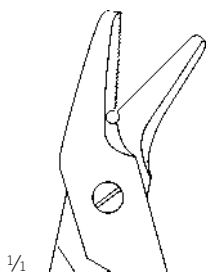

1/1

eine Schneide gezahnt  
 one toothed cutting edge  
 una hoja dentada  
 une lame dentelée  
 una lama dentata

## Ligaturscheren

Ligature Scissors  
Tijeras para ligaduras  
Ciseaux pour ligatures  
Forbici per legature

## Scheren

Scissors  
Tijeras  
Ciseaux  
Forbici

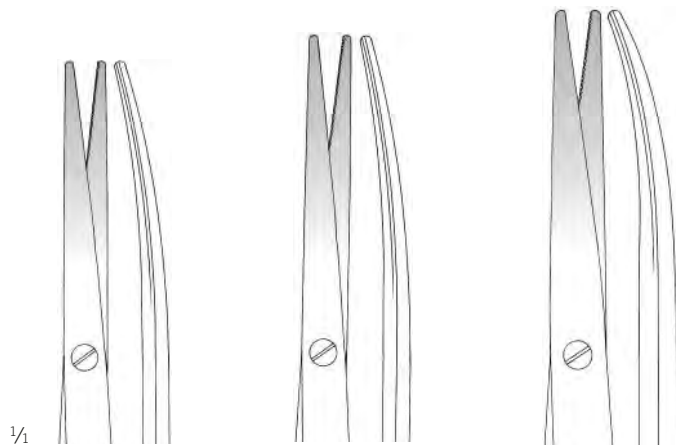
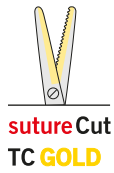

1/4

11-914-14-07  
14,5 cm / 5 3/4"

11-914-18-07  
18 cm / 7"

11-914-20-07  
20,5 cm / 8"

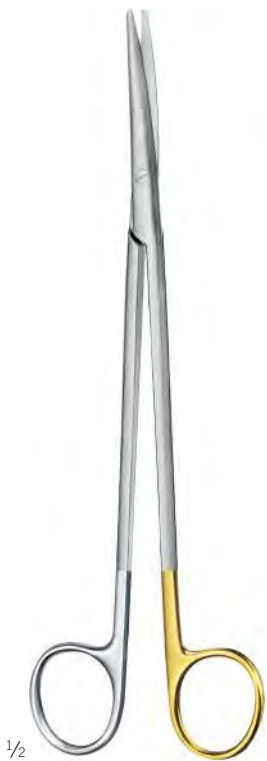

1/2

11-914-14-07 -  
11-914-30-07

für Synthetik-Nahtmaterial,  
eine Schneide gezahnt

for synthetic suture material,  
one toothed cutting edge

para hilos de sutura sintéticos,  
una hoja dentada

pour matériel de suture synthétique,  
une lame dentelée

per materiale di sutura sintetico,  
una lama dentata

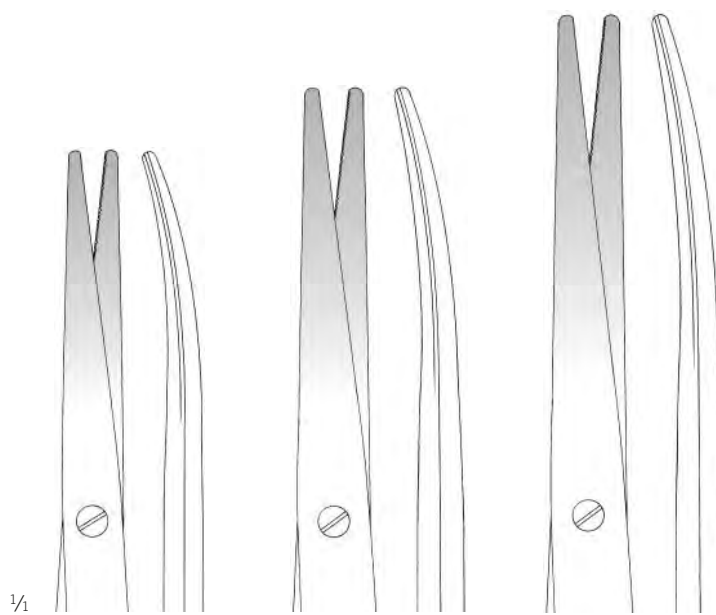

1/4

11-914-23-07  
23 cm / 9"

11-914-25-07  
25 cm / 9 3/4"

11-914-30-07  
30 cm / 11 5/8"

## Ligaturscheren

Ligature Scissors

Tijeras para ligaduras

Ciseaux pour ligatures

Forbici per legature

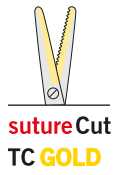

11-915-14-07 -  
11-915-23-07

für Synthetik-Nahtmaterial,  
eine Schneide gezahnt

for synthetic suture material,  
one toothed cutting edge

para hilos de sutura sintéticos,  
una hoja dentada

pour matériel de suture synthétique,  
une lame dentelée

per materiale di sutura sintetico,  
una lama dentata

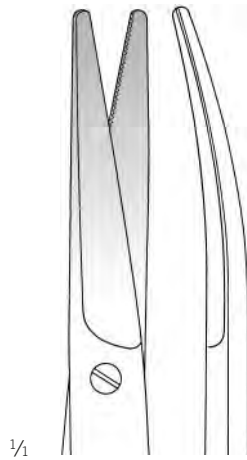

11-915-14-07  
14,5 cm / 5 3/4"

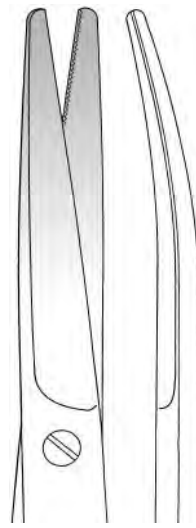

11-915-17-07  
17 cm / 6 3/4"

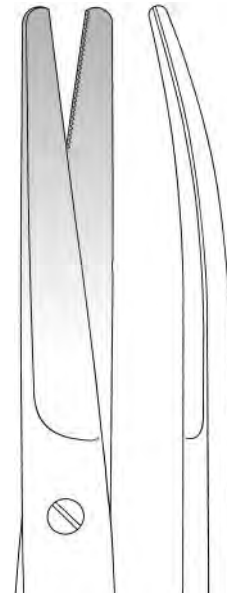

11-915-23-07  
23 cm / 9"

## TCC-BlackLine-Scheren

TCC-BlackLine Scissors

Tijeras TCC-BlackLine

Ciseaux TCC-BlackLine

Forbici TCC-BlackLine

## Scheren

Scissors

Tijeras

Ciseaux

Forbici



TCC BlackLine

finoLine TC GOLD

SB



1/2

11-916-14-07 -  
11-916-20-07

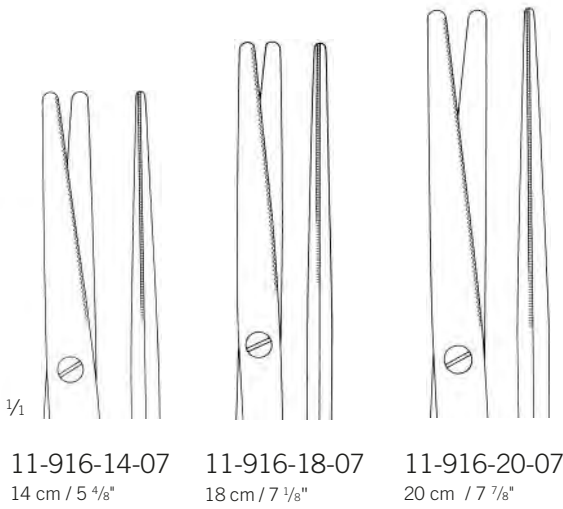

1/1

11-916-14-07  
14 cm / 5 4/8"

11-916-18-07  
18 cm / 7 1/8"

11-916-20-07  
20 cm / 7 7/8"



1/2

Tönnis-Adson TCC-BlackLine  
11-919-14-07 -  
11-919-18-07

sehr fein  
very delicate  
muy fino  
très fin  
strafino

Keramik-Beschichtung,  
eine Schneide gezahnt

Coated with ceramics,  
one toothed cutting edge

Cubierto con material de cerámicas,  
una hoja dentada

Recouvert avec matériau de la  
céramique, une lame dentelée

Ricoprito con materiale di ceramica,  
una lama dentata

## Präparierscheren, Chirurgische Scheren, Feine Präparierscheren

Dissecting Scissors, Operating Scissors, Delicate Dissecting Scissors

Tijeras de disección, Tijeras quirúrgicas, Tijeras finas de disección

Ciseaux à dissection, Ciseaux chirurgicaux, Ciseaux fins à dissection

Forbici per dissezione, Forbici per chirurgia, Forbici fini per dissezione

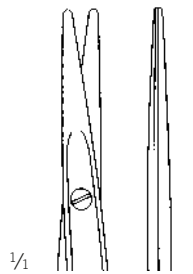

11-934-12-07

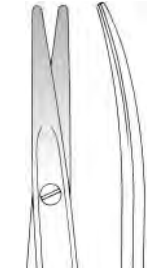

11-935-12-07

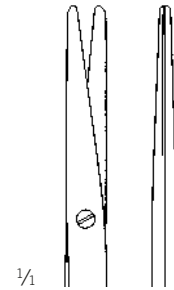

11-950-10-07

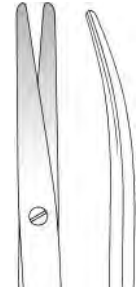

11-951-10-07

Knapp  
11-934-12-07 -  
11-935-12-07  
12,5 cm / 4 7/8"

Lexer  
11-950-10-07 -  
11-951-10-07  
10 cm / 3 7/8"

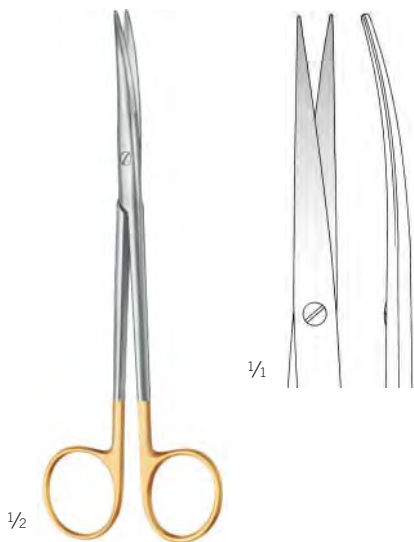

Metzenbaum-Lahey  
11-965-14-07

14,5 cm / 5 6/8"  
schlankes Modell  
slender pattern  
modelo delgado  
modèle gracile  
modello delicato



Pinzetten  
Forceps  
Pinzas  
Pincers  
Pinze



## Anatomische Pinzetten

Dissecting Forceps  
Pinzas de disección  
Pincès à dissection  
Pinze per dissezione

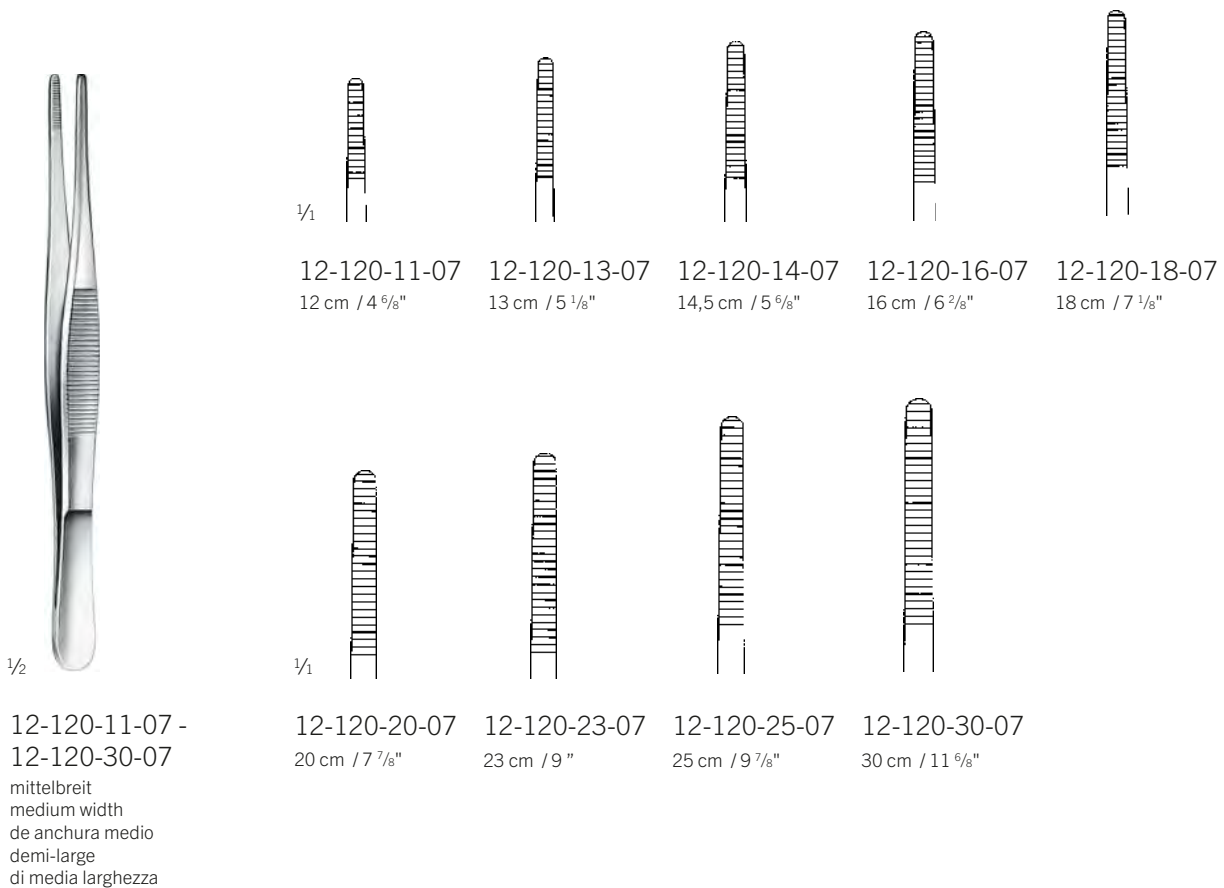
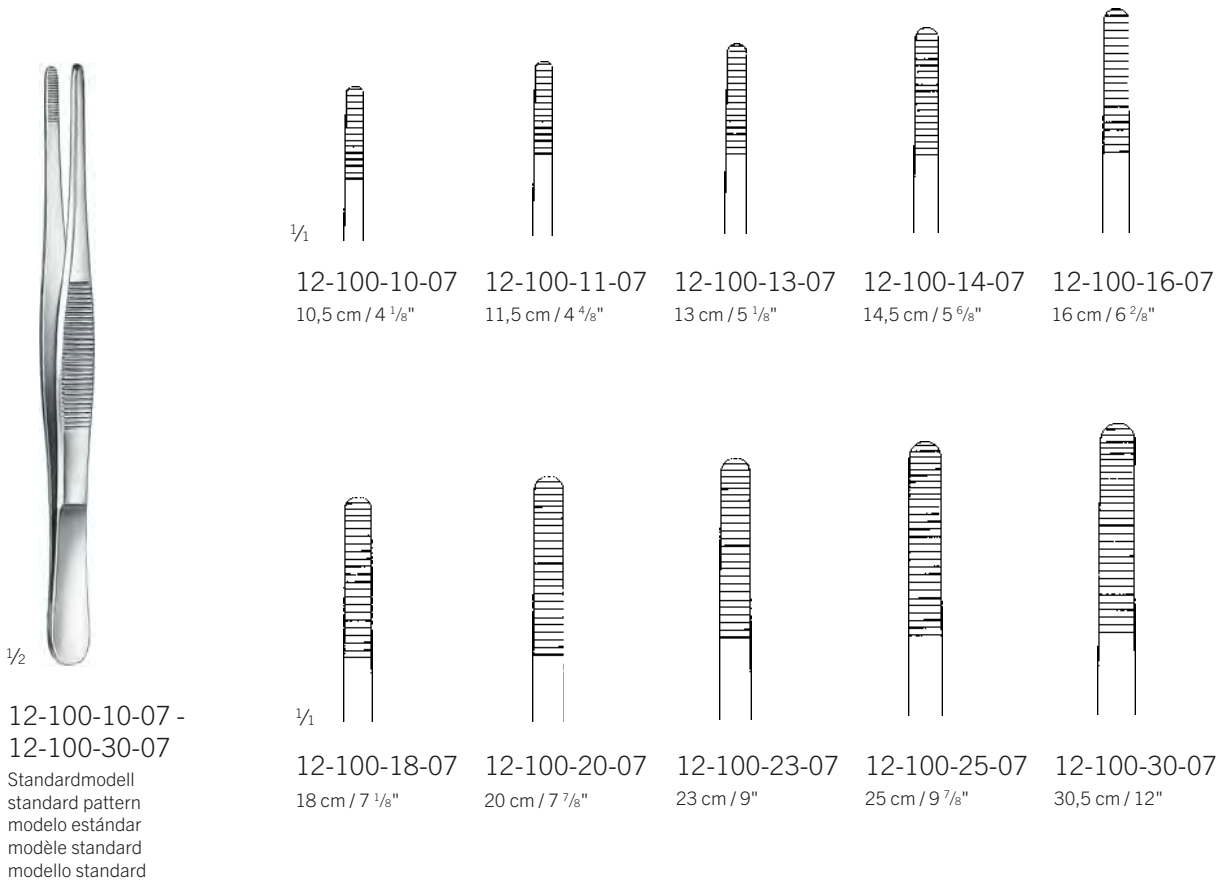

# Anatomische Pinzetten

Dissecting Forceps  
 Pinzas de disección  
 Pincès à dissection  
 Pinze per dissezione

# Pinzetten

Forceps  
 Pinzas  
 Pincès  
 Pinze

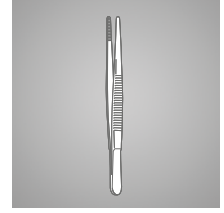

12-122-13-07  
 13 cm / 5 1/8"



12-126-13-07 -  
 12-126-14-07



12-126-13-07  
 13 cm / 5 1/8"



12-126-14-07  
 14,5 cm / 5 6/8"



12-132-19-07  
 18,5 cm / 7 2/8"



12-134-20-07  
 20 cm / 7 7/8"



Adson  
 12-168-12-07 -  
 12-168-15-07

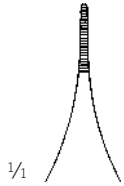

12-168-12-07  
 12 cm / 4 6/8"

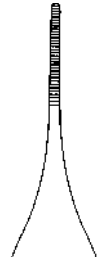

12-168-15-07  
 15 cm / 5 7/8"



McIndoe  
 12-170-15-07  
 15 cm / 5 7/8"

## Anatomische Pinzetten

Dissecting Forceps  
Pinzas de disección  
Pincers à dissection  
Pinze per dissezione



1/2

Semken

12-172-12-07 - 12-172-15-07



1/4

12-172-12-07  
12,5 cm / 4 7/8"



12-172-15-07  
15 cm / 5 7/8"



1/2

Gerald

12-186-18-07 - 12-187-18-07

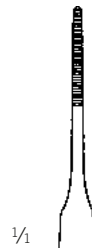

1/4

12-186-18-07  
17,5 cm / 6 7/8"



12-187-18-07  
17 cm / 6 5/8"



1/2

Potts-Smith

12-192-18-07 - 12-192-30-07



1/4

12-192-18-07  
18 cm / 7 1/8"



12-192-21-07  
21 cm / 8 2/8"



12-192-25-07  
25 cm / 9 7/8"



12-192-30-07  
30 cm / 11 5/8"

## Chirurgische Pinzetten, Anatomische Pinzetten

Tissue Forceps, Dissecting Forceps

Pinzas de disección con diente, Pinzas de disección

Pinces à dissection à griffes, Pinces à dissection

Pinze per dissezione con denti, Pinze per dissezione

## Pinzetten

Forceps

Pinzas

Pinces

Pinze

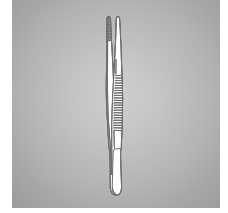

McIndoe  
12-238-15-07

15 cm / 5 7/8"

Miniprofil  
mini profile  
perfil mini  
profil mini  
mini-profilo



Semken  
12-240-16-07 -  
12-242-18-07



12-240-16-07

15,5 cm / 6 1/8"

Normalprofil  
normal profile  
perfil normal  
profil normal  
profilo normale



12-240-18-07

17,5 cm / 6 7/8"

Normalprofil  
normal profile  
perfil normal  
profil normal  
profilo normale



12-242-16-07

15,5 cm / 6 1/8"

Miniprofil  
mini profile  
perfil mini  
profil mini  
mini-profilo



12-242-18-07

17,5 cm / 6 7/8"

Miniprofil  
mini profile  
perfil mini  
profil mini  
mini-profilo



# Chirurgische Pinzetten, Anatomische Pinzetten







Tissue Forceps, Dissecting Forceps

Pinzas de disección con diente, Pinzas de disección

Pinces à dissection à griffes, Pinces à dissection

Pinze per dissezione con denti, Pinze per dissezione

## TC GOLD

|   |  |  |  |   |
|---|--|--|--|---|
|  <p>1/2</p>  |  <p>1/1</p> |  <p>1/2</p> |  <p>1/1</p> |                                      |
| <p><b>Adson-Brown</b><br/>12-244-12-07<br/>12 cm / 4 5/8"<br/>Normalprofil<br/>normal profile<br/>perfil normal<br/>profil normal<br/>profilo normale</p> |  | <p><b>Adson</b><br/>12-246-12-07 -<br/>12-246-15-07</p>                                      |  | <p>12-246-12-07<br/>12 cm / 4 5/8"<br/>Miniprofil<br/>mini profile<br/>perfil mini<br/>profil mini<br/>mini-profilo</p> |
|   |  |  1:2        |  |  1:2                                 |

|  |  |  |  |  |
|--|--|--|--|--|
|  <p>1/2</p> |  <p>1/1</p> |   |   |   |
| <p><b>Adson</b><br/>12-250-12-07 -<br/>12-252-15-07</p>  |  | <p>12-250-12-07<br/>12 cm / 4 5/8"<br/>Normalprofil<br/>normal profile<br/>perfil normal<br/>profil normal<br/>profilo normale</p> | <p>12-250-15-07<br/>15 cm / 5 7/8"<br/>Normalprofil<br/>normal profile<br/>perfil normal<br/>profil normal<br/>profilo normale</p> | <p>12-252-12-07<br/>12 cm / 4 5/8"<br/>Normalprofil<br/>normal profile<br/>perfil normal<br/>profil normal<br/>profilo normale</p> |
|  |  |  1:2  |  |  1:2  |

# Anatomische Pinzetten

Dissecting Forceps  
Pinzas de disección  
Pincès à dissection  
Pinze per dissezione

# Pinzetten

Forceps  
Pinzas  
Pincès  
Pinze

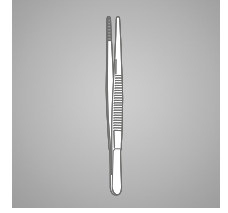

## TC GOLD

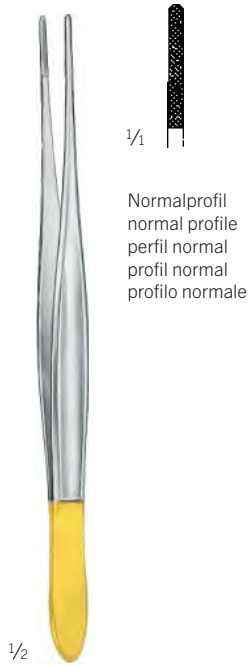

Cushing  
12-254-17-07  
17,5 cm / 6 7/8"



Cushing  
12-255-18-07  
17 cm / 6 5/8"

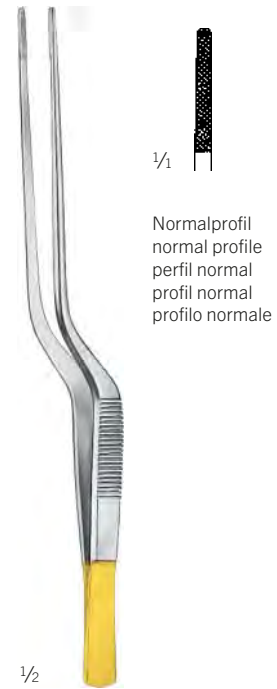

Cushing-Taylor  
12-256-18-07  
18,5 cm / 7 3/8"



Potts-Smith  
12-258-14-07 - 12-258-25-07

Normalprofil  
normal profile  
perfil normal  
profil normal  
profilo normale

## Chirurgische Pinzetten

Tissue Forceps

Pinzas de disección con diente

Pinces à dissection à griffes

Pinze per dissezione con denti



1/2

12-301-10-07 -  
12-301-30-07

Standardmodell  
standard pattern  
modelo estándar  
modèle standard  
modello standard

|     |                                  |                                  |                                |                                  |                                |
|-----|----------------------------------|----------------------------------|--------------------------------|----------------------------------|--------------------------------|
| 1/4 |                                  |                                  |                                |                                  |                                |
|     | 12-301-10-07<br>10,5 cm / 4 1/8" | 12-301-11-07<br>12 cm / 4 7/8"   | 12-301-13-07<br>13 cm / 5 1/8" | 12-301-14-07<br>14,5 cm / 5 7/8" | 12-301-16-07<br>16 cm / 6 2/8" |
|     | 1:2                              | 1:2                              | 1:2                            | 1:2                              | 1:2                            |
| 1/4 |                                  |                                  |                                |                                  |                                |
|     | 12-301-18-07<br>18 cm / 7 1/8"   | 12-301-20-07<br>20,5 cm / 8 1/8" | 12-301-25-07<br>25 cm / 9 7/8" | 12-301-30-07<br>30,5 cm / 12"    |                                |
|     | 1:2                              | 1:2                              | 1:2                            | 1:2                              |                                |



1/2

12-302-13-07 -  
12-302-20-07

|     |                                |                                  |                                |                                |                                  |
|-----|--------------------------------|----------------------------------|--------------------------------|--------------------------------|----------------------------------|
| 1/4 |                                |                                  |                                |                                |                                  |
|     | 12-302-13-07<br>13 cm / 5 1/8" | 12-302-14-07<br>14,5 cm / 5 7/8" | 12-302-16-07<br>16 cm / 6 2/8" | 12-302-18-07<br>18 cm / 7 1/8" | 12-302-20-07<br>20,5 cm / 8 1/8" |
|     | 2:3                            | 2:3                              | 2:3                            | 2:3                            | 2:3                              |



# Chirurgische Pinzetten

Tissue Forceps  
 Pinzas de disección con diente  
 Pincès à dissection à griffes  
 Pinze per dissezione con denti

# Pinzetten

Forceps  
 Pinzas  
 Pincès  
 Pinze

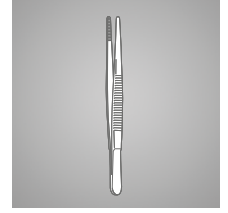

12-303-14-07  
14,5 cm / 5 7/8"

12-303-16-07  
16 cm / 6 2/8"

12-303-20-07  
20 cm / 7 7/8"

3:4

3:4

3:4

1/2

12-303-14-07 - 12-303-20-07

12-304-14-07  
14,5 cm / 5 7/8"

12-304-16-07  
16 cm / 6 2/8"

4:5

4:5

1/2

12-304-14-07 - 12-304-16-07

12-321-13-07  
13 cm / 5 1/8"

12-321-14-07  
14,5 cm / 5 6/8"

12-321-16-07  
16 cm / 6 2/8"

12-321-18-07  
18 cm / 7 1/8"

12-321-20-07  
20,5 cm / 8 1/8"

1:2

1:2

1:2

1:2

1:2

1:2

1:2

1/2

12-321-13-07 - 12-321-20-07

mittelbreit  
 medium  
 medio  
 moyen  
 medio

12-323-15-07

14,5 cm / 5 7/8"

## Chirurgische Pinzetten

Tissue Forceps

Pinzas de disección con diente

Pinces à dissection à griffes

Pinze per dissezione con denti

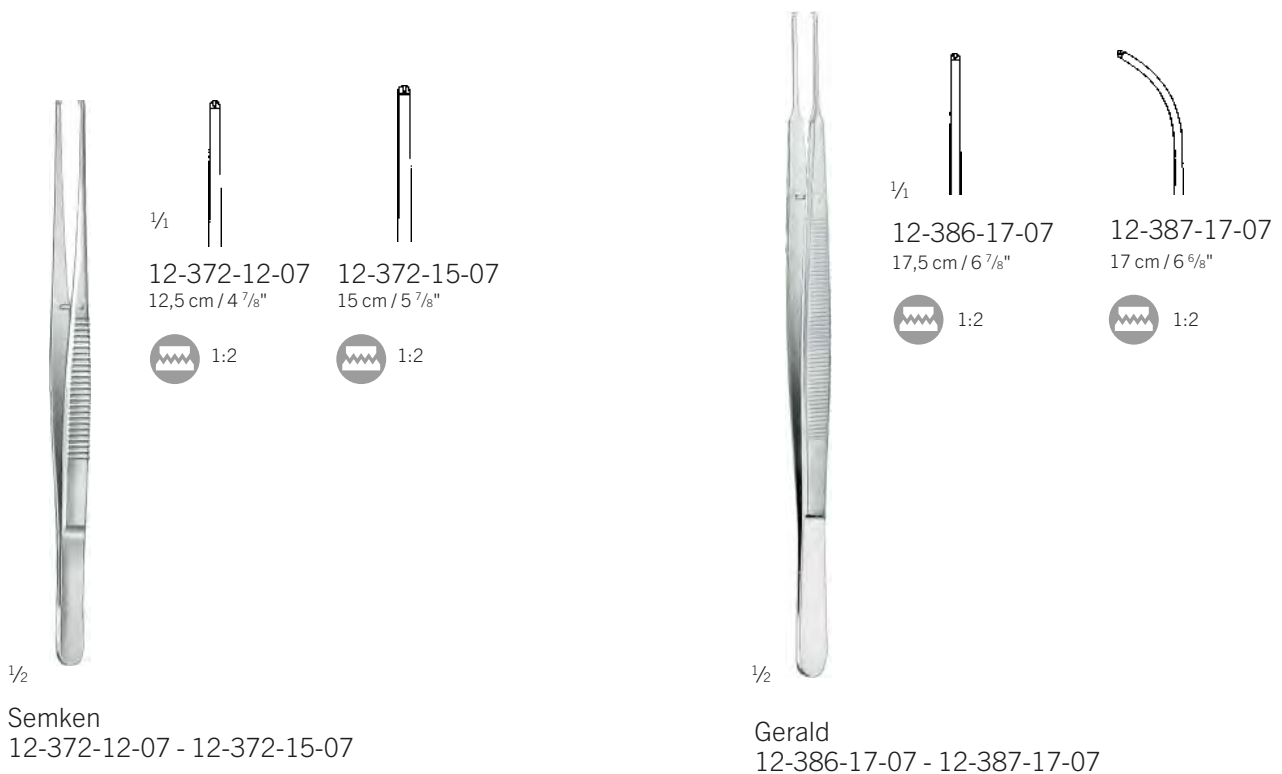
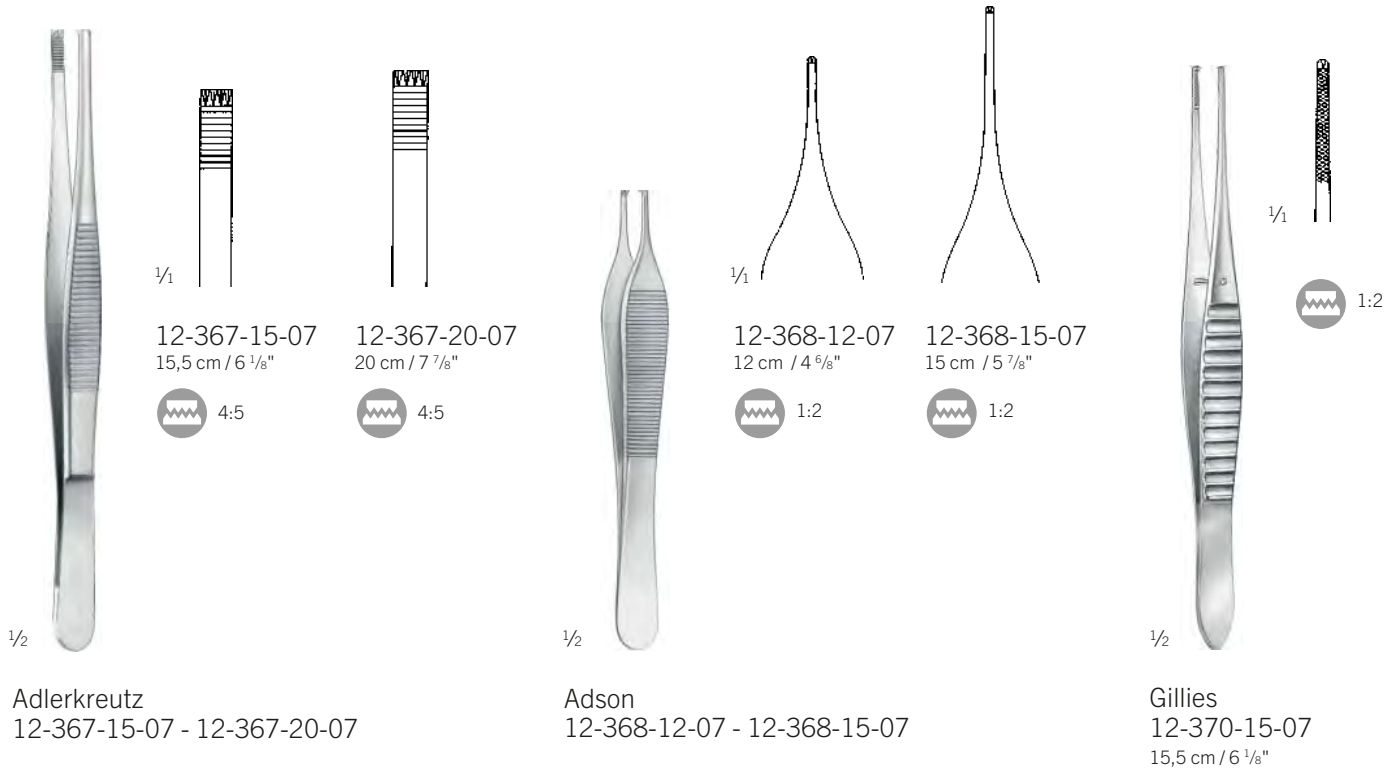



# Chirurgische Pinzetten

Tissue Forceps  
 Pinzas de disección con diente  
 Pincès à dissection à griffes  
 Pinze per dissezione con denti

# Pinzetten

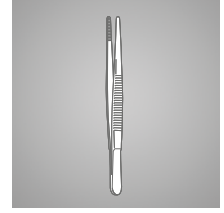
Forceps  
 Pinzas  
 Pincès  
 Pinze

1/2

Potts-Smith  
 12-392-18-07 -  
 12-392-30-07

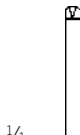

1/1

12-392-18-07  
 18 cm / 7 1/8"

 1:2

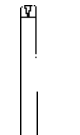



12-392-21-07  
 21 cm / 8 2/8"

 1:2



12-392-25-07  
 25 cm / 9 7/8"

 1:2





1/2

Adson-Brown  
 12-400-12-07  
 12 cm / 4 6/8"



1/1

 7:7



1/2

Mikro-Adson  
 12-404-12-07 - 12-404-15-07



1/1

12-404-12-07  
 12 cm / 4 6/8"



12-404-15-07  
 15 cm / 5 7/8"



1/2

Mikro-Adson  
 12-406-12-07 - 12-406-15-07



1/1

12-406-12-07  
 12 cm / 4 6/8"

 1:2



12-406-15-07  
 15 cm / 5 7/8"

 1:2

## Gefäßpinzetten

Vascular Forceps

Pinzas de disección vascular

Pinces à dissection vasculaires

Pinze per dissezione vascolari

**Atrauma**

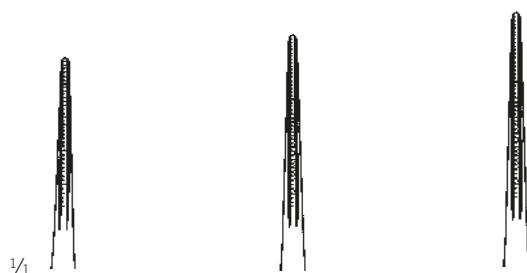

|                |                |                |
|----------------|----------------|----------------|
| <b>1,5 mm</b>  | <b>1,5 mm</b>  | <b>1,5 mm</b>  |
| 24-386-16-07   | 24-386-20-07   | 24-386-24-07   |
| 16 cm / 6 2/8" | 20 cm / 7 7/8" | 25 cm / 9 7/8" |

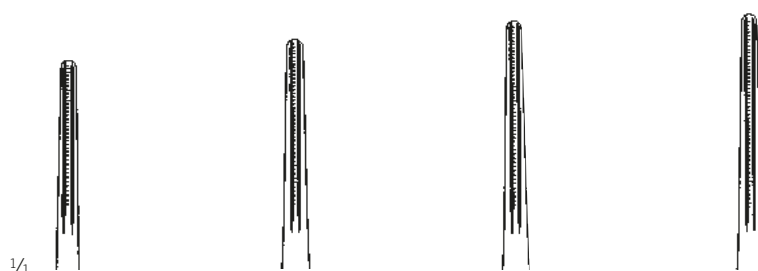

|                |                |                |                 |
|----------------|----------------|----------------|-----------------|
| <b>2,0 mm</b>  | <b>2,0 mm</b>  | <b>2,0 mm</b>  | <b>2,0 mm</b>   |
| 24-388-16-07   | 24-388-20-07   | 24-388-24-07   | 24-388-30-07    |
| 16 cm / 6 2/8" | 20 cm / 7 7/8" | 25 cm / 9 7/8" | 30 cm / 11 6/8" |

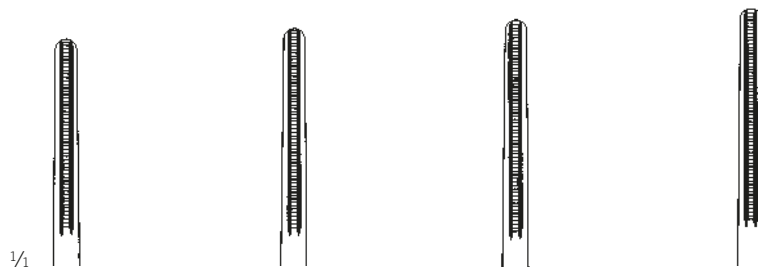

|                |                |                |                 |
|----------------|----------------|----------------|-----------------|
| <b>2,7 mm</b>  | <b>2,7 mm</b>  | <b>2,7 mm</b>  | <b>2,7 mm</b>   |
| 24-384-16-07   | 24-384-20-07   | 24-384-24-07   | 24-384-30-07    |
| 16 cm / 6 2/8" | 20 cm / 7 7/8" | 25 cm / 9 7/8" | 30 cm / 11 6/8" |



1/2

De Bakey  
24-384-16-07 -  
24-390-30-07

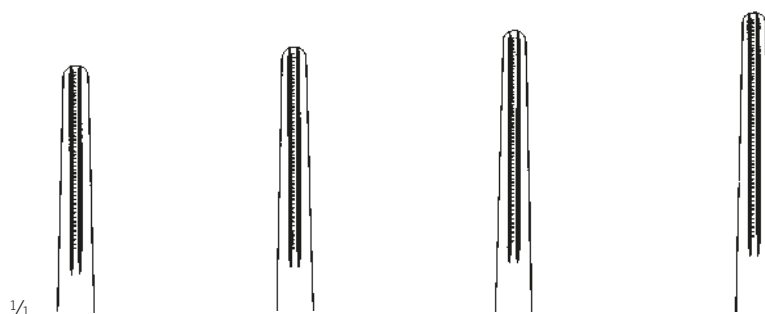

|                |                |                |                 |
|----------------|----------------|----------------|-----------------|
| <b>3,5 mm</b>  | <b>3,5 mm</b>  | <b>3,5 mm</b>  | <b>3,5 mm</b>   |
| 24-390-16-07   | 24-390-20-07   | 24-390-24-07   | 24-390-30-07    |
| 16 cm / 6 2/8" | 20 cm / 7 7/8" | 25 cm / 9 7/8" | 30 cm / 11 6/8" |

## Gefäßpinzetten

Vascular Forceps  
Pinzas de disección vascular  
Pincas à dissection vasculaires  
Pinze per dissezione vascolari

## Pinzetten

Forceps  
Pinzas  
Pincas  
Pinze

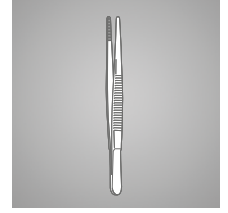

## Atrauma



1/2

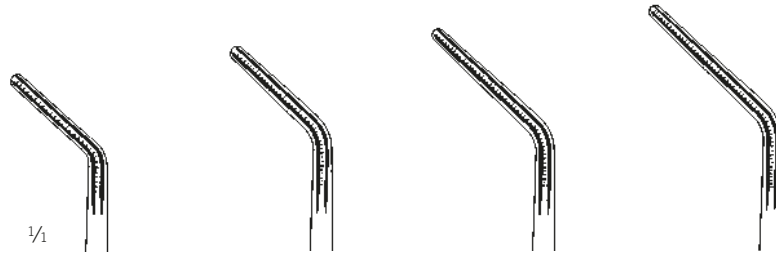

| 2,0 mm         | 2,0 mm         | 2,0 mm         | 2,0 mm          |
|----------------|----------------|----------------|-----------------|
| 24-389-16-07   | 24-389-20-07   | 24-389-24-07   | 24-389-30-07    |
| 16 cm / 6 2/8" | 20 cm / 7 7/8" | 25 cm / 9 7/8" | 30 cm / 11 6/8" |

De Bakey  
24-389-16-07 -  
24-389-30-07

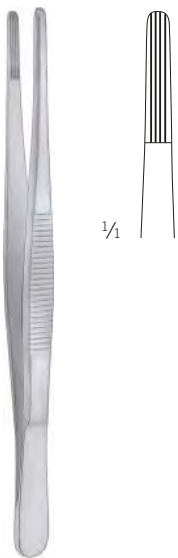

1/1

1/2

Ochsner  
20-894-14-07

14,5 cm / 5 6/8"

Fadenpinzette  
Thread forceps  
Pinzas para ligaduras  
Pince à fil  
Pinze porta-filo

## Pinzetten, bajonett

Forceps, bayonet  
Pinzas, bayoneta  
Pinces, baïonnette  
Pinze, baionetta



Grünwald  
36-391-14-07  
14,5 cm / 5 <sup>6</sup>/<sub>8</sub>"  
Ohrpinzetten  
Ear forceps  
Pinzas auriculares  
Pinces auriculaires  
Pinze auricolari



Jansen  
36-395-16-07 -  
36-395-20-07



36-395-16-07  
16 cm / 6 <sup>2</sup>/<sub>8</sub>"

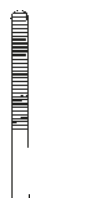

36-395-20-07  
21,5 cm / 8 <sup>4</sup>/<sub>8</sub>"



Grünwald (Jansen)  
37-115-16-07 - 37-115-20-07  
Nasentamponpinzette  
Nasal tampon forceps  
Pinzas para tampones nasales  
Pince pour pansements nasales  
Pinze per tamponi nasali



37-115-16-07  
16 cm / 6 <sup>2</sup>/<sub>8</sub>"



37-115-20-07  
21,5 cm / 8 <sup>4</sup>/<sub>8</sub>"



Cottle  
37-731-14-07  
14 cm / 5 <sup>4</sup>/<sub>8</sub>"

Hautfasspinzette, mit Zähnen  
Skin grasping forceps, with teeth  
Pinzas para piel, con dientes  
Pinces pour saisir la peau, avec dents  
Pinze per afferrare la pelle, con denti

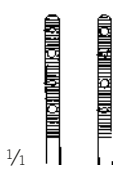

1,7 mm

Klemmen  
Forceps  
Pinzas  
Pinces  
Pinze

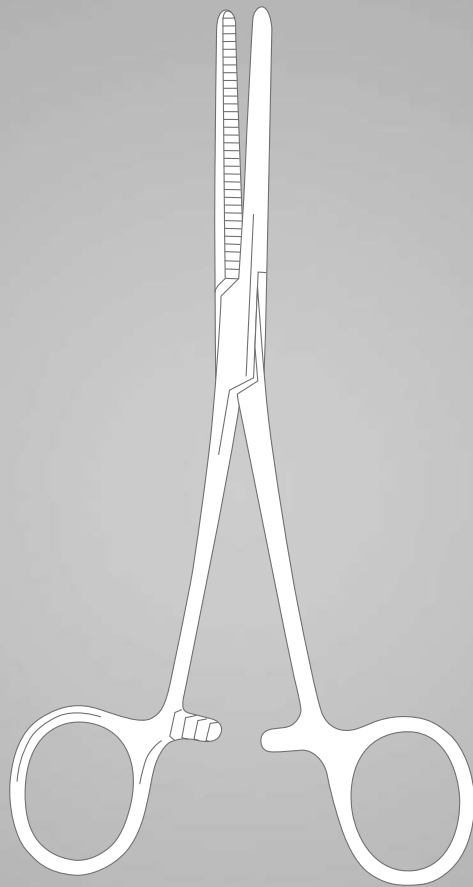

## Clip-Anlegepinzette, Gefäßclips

Clip Applying Forceps, Vessel Clips

Pinzas para aplicar clips,

Pinces pour poser les clips vasculaires, Clips vasculaires

Pinze per applicazione clips vascolari,



Biemer  
13-010-00-07

16 cm / 6 2/8"

Gefäßspreizer  
Vascular spreader  
Dilatador de vasos  
Ecarteur vasculaire  
Dilatatore vascolare



13-050-14-07

14,5 cm / 5 5/8"

ohne Sperre  
w/o ratchet  
sin cremallera  
sans cremaillère  
senza cremagliera

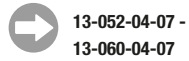

13-051-14-07

14,5 cm / 5 5/8"

mit Sperre  
with ratchet  
con cremallera  
avec cremaillère  
con cremagliera

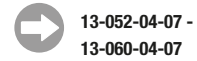

Biemer  
13-052-04-07 -  
13-053-05-07



| St | 13-052-04-07 | 13-052-05-07 | 13-053-05-07 |
|----|--------------|--------------|--------------|
|    | 14 mm        | 17 mm        | 17 mm        |
|    | 6 mm         | 9 mm         | 9 mm         |
|    | 4 mm         | 7 mm         | 7 mm         |
|    | 30 - 40 g    | 30 - 40 g    | 20 - 25 g    |



## Gefäßclips, Approximatoren

Vessel Clips, Approximators  
Clips vasculares, Aproximadores  
Clips vasculaires, Approximateurs  
Clip vascolari, Approssimatori

## Klemmen

Forceps  
Pinzas  
Pincers  
Pinze



Biemer-Müller  
13-054-05-07 -  
13-059-05-07



|    | gerade, breit<br>straight, wide<br>recto, ancho<br>droit, large<br>retto, largo | gewinkelt, breit<br>angled, wide<br>angulado, ancho<br>coudé, large<br>angulato, largo | gerade, schmal<br>straight, narrow<br>recto, estrecho<br>droit, étroit<br>retto, stretto | gerade, schmal<br>straight, narrow<br>recto, estrecho<br>droit, étroit<br>retto, stretto | gewinkelt, schmal<br>angled, narrow<br>angulado, estrecho<br>coudé, étroit<br>angulato, stretto |
|----|---|--|--|--|---|
| St | 13-054-05-07  | 13-055-05-07   | 13-056-03-07   | 13-058-05-07   | 13-059-05-07  |
|    | 17 mm   | 17 mm  | 13 mm  | 17 mm  | 17 mm   |
|    | 9 mm  | 9 mm   | 4,5 mm   | 9 mm   | 9 mm  |
|    | 7 mm  | 7 mm   | 4 mm   | 7 mm   | 7 mm  |
| P  | 30 - 40 g   | 30 - 40 g  | 30 - 40 g  | 30 - 40 g  | 25 - 30 g   |

## Approximatoren, Nerv-Approximatoren

Approximators, Nerve Approximators

Aproximadores, Aproximadores para nervios

Approximateurs, Approximateurs pour nerfs

Approssimatori, Approssimatori per nervi

für Mikro-Gefäß Anastomosen in der Tiefe  
for Micro vessel anastomosis in the depth  
para micro anastomosis en la profundidad  
pour micro-anastomoses vasculaires en profondeur  
per micro-anastomosi vascolari nella profondità

1/1



13-062-00-07

komplett mit Schlüssel  
complete with key  
completo con llave  
complet avec clef  
completti con chiave

1/1



1/1



13-062-01-07

Schlüssel für Approximator  
Key for Approximator  
Llave para aproximador  
Clef pour approximateur  
Chiave per approssimatore



13-062-02-07 & 13-063-02-07

1/1



13-062-02-07

Approximator, allein  
Approximator, only  
Aproximador, suelto  
Approximateur, seul  
Approssimatore, solo

## Mini-Gefäßclips, Clip-Anlegezangen, Bulldogklemmen

Mini Vessel Clips, Clip Applying Forceps

Mini Clips vasculaires, Pinzas para aplicar clips

Micro-clips vasculaires, Pincers pour poser micro-clips

Mini-clip vascolari, Pinze per applicare clips vascolari

## Klemmen

Forceps

Pinzas

Pincers

Pinze



1/1

13-102-04-07 -  
13-102-10-07

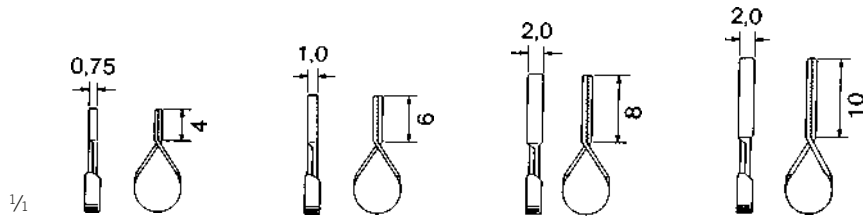

| St | 13-102-04-07 | 13-102-06-07 | 13-102-08-07 | 13-102-10-07 |
|----|--------------|--------------|--------------|--------------|
|    | 13 mm        | 15 mm        | 17 mm        | 20 mm        |
|    | 4 mm         | 6 mm         | 8 mm         | 10 mm        |
|    | 4 mm         | 5 mm         | 6 mm         | 7 mm         |
|    | 60 g         | 85 g         | 100 g        | 125 g        |



1/2

13-104-14-07

14,5 cm / 5 7/8"

mit Sperre  
with ratchet  
con cremallera  
avec cremailière  
con cremagliera



13-102-04-07 -  
13-102-10-07



1/2

13-106-18-07

18,5 cm / 7 2/8"

mit Sperre  
with ratchet  
con cremallera  
avec cremailière  
con cremagliera



13-102-04-07 -  
13-102-10-07

## Arterienklemmen

Haemostatic Forceps  
Pinzas hemostáticas  
Pincers hémostatiques  
Pinze emostatiche



1/2

13-303-01-07

13,5 cm / 5 3/8"



13-303-02-07

13 cm / 5 1/8"

Mixer-Baby  
13-303-01-07 -  
13-303-02-07

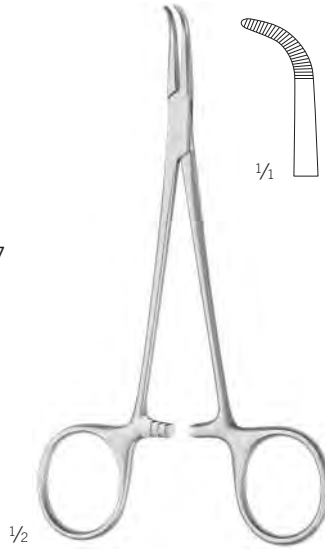

1/2

Mikro-Adson  
13-304-14-07

14 cm / 5 4/8"



1/2

Baby-Adson  
13-305-18-07

18 cm / 7 1/8"



1/2

Halsted-Mosquito  
13-310-12-07 -  
13-313-14-07

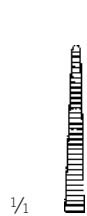

1/2

13-310-12-07

12,5 cm / 4 7/8"



13-310-14-07

14,5 cm / 5 6/8"



13-311-12-07

12 cm / 4 6/8"



13-311-14-07

14 cm / 5 4/8"



1/2

13-312-12-07

12,5 cm / 4 7/8"



13-312-14-07

14,5 cm / 5 6/8"

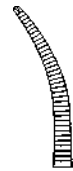

13-313-12-07

12,5 cm / 4 7/8"



13-313-14-07

14,5 cm / 5 6/8"



1:2



1:2



1:2



1:2

## Arterienklemmen

Haemostatic Forceps  
Pinzas hemostáticas  
Pincas hémostatiques  
Pinze emostatiche

## Klemmen

Forceps  
Pinzas  
Pincas  
Pinze



1/2

Halsted-Mosquito  
13-316-18-07 -  
13-319-21-07

1/4



13-316-18-07  
18,5 cm / 7 3/8"



13-316-21-07  
21 cm / 8 3/8"

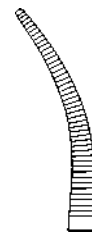

13-317-18-07  
18 cm / 7 1/8"

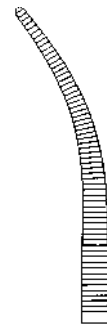

13-317-21-07  
20,5 cm / 8 1/8"

1/4



13-318-18-07  
18,5 cm / 7 3/8"



13-318-21-07  
21 cm / 8 3/8"



13-319-18-07  
18 cm / 7 1/8"



13-319-21-07  
20,5 cm / 8 1/8"



1:2



1:2



1:2



1:2

## Arterienklemmen

Haemostatic Forceps  
Pinzas hemostáticas  
Pincès hémostatiques  
Pinze emostatiche



Providence-Hospital  
13-324-14-07 -  
13-325-14-07

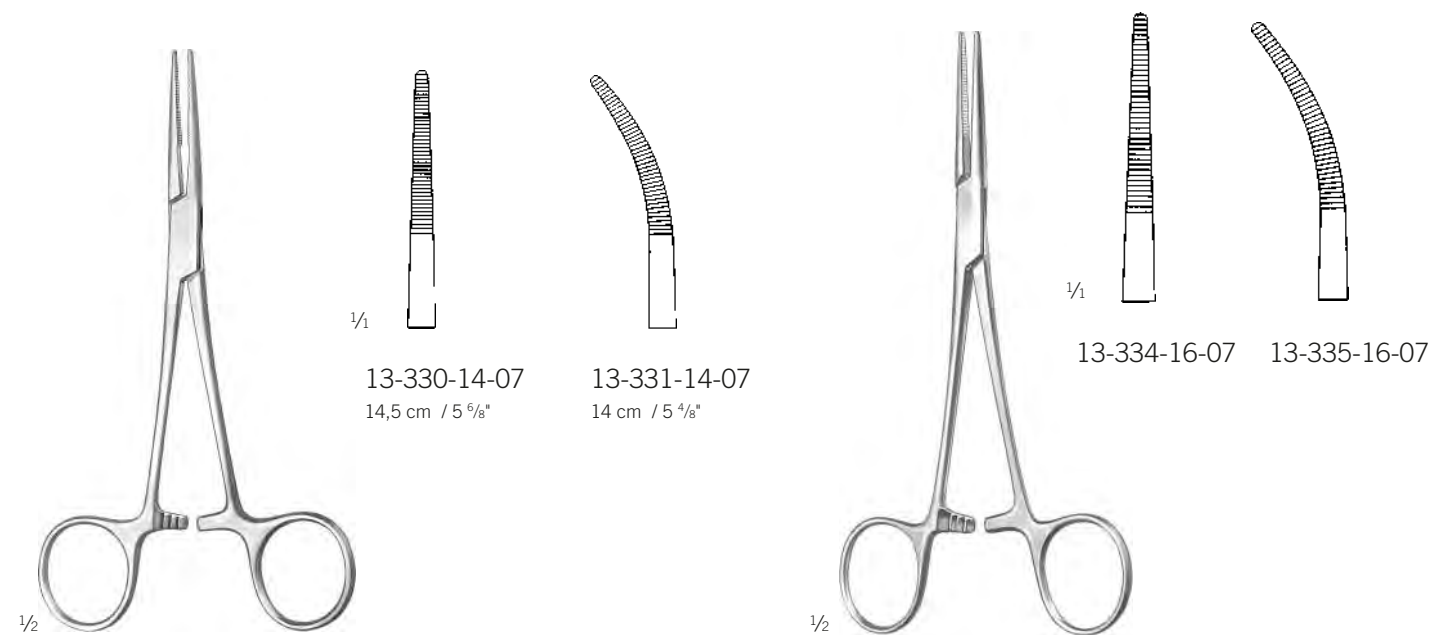

Kelly  
13-330-14-07 -  
13-331-14-09

Kelly-Rankin  
13-334-16-07 -  
13-335-16-07  
16 cm / 6 2/8"

## Arterienklemmen

Haemostatic Forceps  
Pinzas hemostáticas  
Pincès hémostatiques  
Pinze emostatiche

## Klemmen

Forceps  
Pinzas  
Pincès  
Pinze



1/2

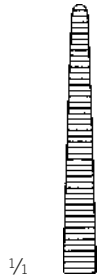

1/4

13-340-14-07

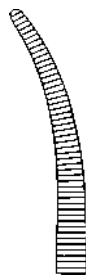

13-341-14-07



13-342-14-07

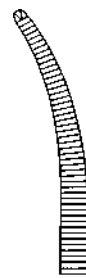

13-343-14-07



1:2



1:2

Crile  
13-340-14-07 -  
13-343-14-07  
14,5 cm / 5 7/8"



1/2

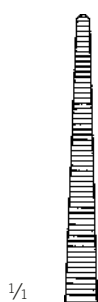

1/4

13-346-16-07

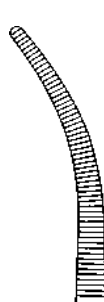

13-347-16-07

Crile-Rankin  
13-346-16-07 -  
13-347-16-07  
16 cm / 6 2/8"



1/2

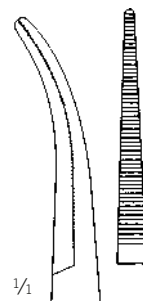

1/4

13-355-14-07  
14,5 cm / 5 6/8"

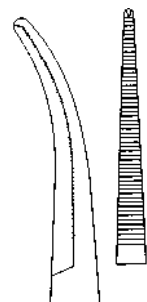

13-357-14-07  
14 cm / 5 4/8"



1:2

Dandy  
13-355-14-07 -  
13-357-14-07  
seitlich gebogen  
laterally curved  
curva lateralmente  
courbe lateralement  
curva laterale

## Arterienklemmen

Haemostatic Forceps  
Pinzas hemostáticas  
Pincers hémostatiques  
Pinze emostatiche



1/2

Pean  
13-374-13-07 -  
13-375-16-07

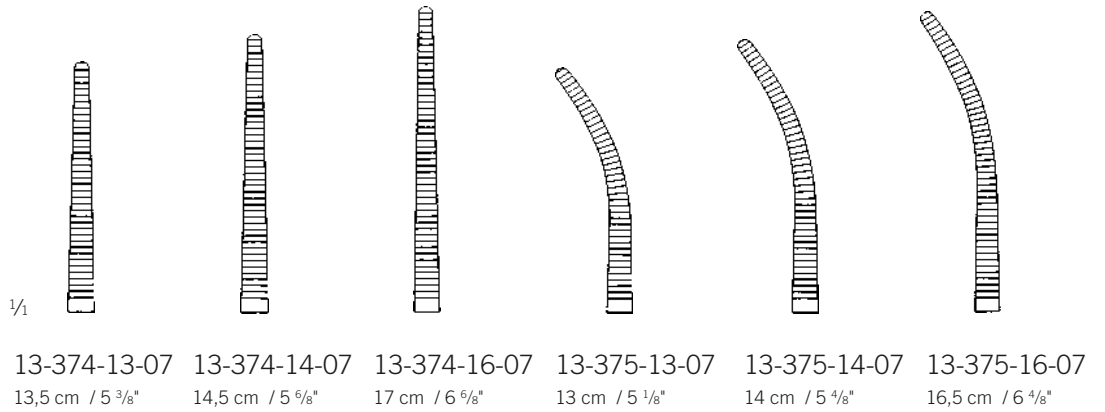

1/2

Kocher  
13-384-13-07 -  
13-385-16-07

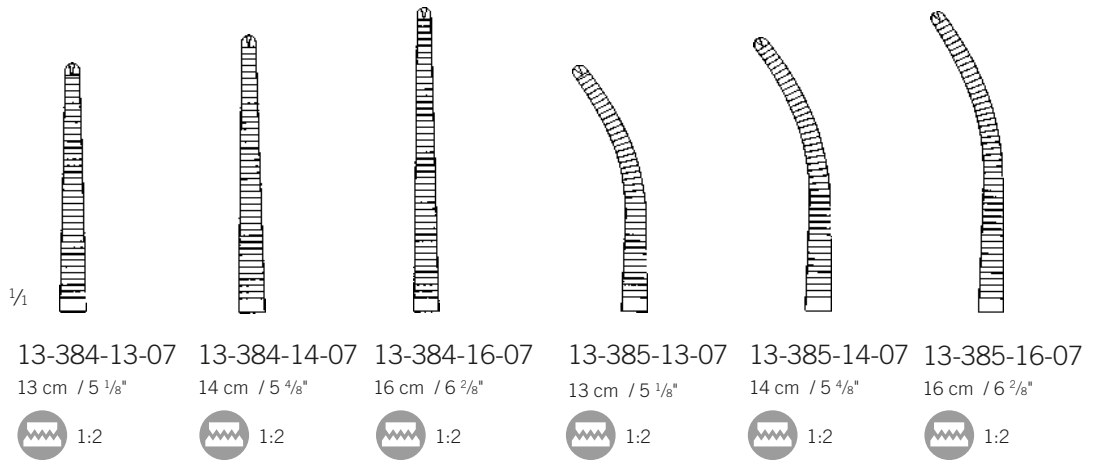



## Arterienklemmen

Haemostatic Forceps  
Pinzas hemostáticas  
Pincès hémostatiques  
Pinze emostatiche

## Klemmen

Forceps  
Pinzas  
Pincès  
Pinze



1/1



13-410-14-07  
14,5 cm / 5 7/8"



13-410-16-07  
16,5 cm / 6 4/8"

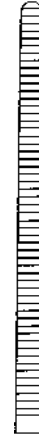

13-410-18-07  
18,5 cm / 7 3/8"



13-410-20-07  
20,5 cm / 8 1/8"

1/1

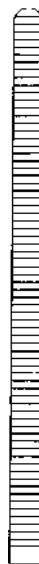

13-410-22-07  
22,5 cm / 8 7/8"

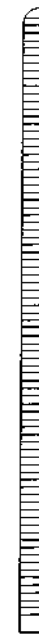

13-410-24-07  
24 cm / 9 4/8"

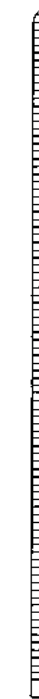

13-410-26-07  
26 cm / 10 2/8"



13-410-30-07  
31 cm / 12 2/8"

1/2



Pean (Rochester)  
13-410-14-07 -  
13-410-30-07

## Arterienklemmen

Haemostatic Forceps

Pinzas hemostáticas

Pinces hémostatiques

Pinze emostatiche

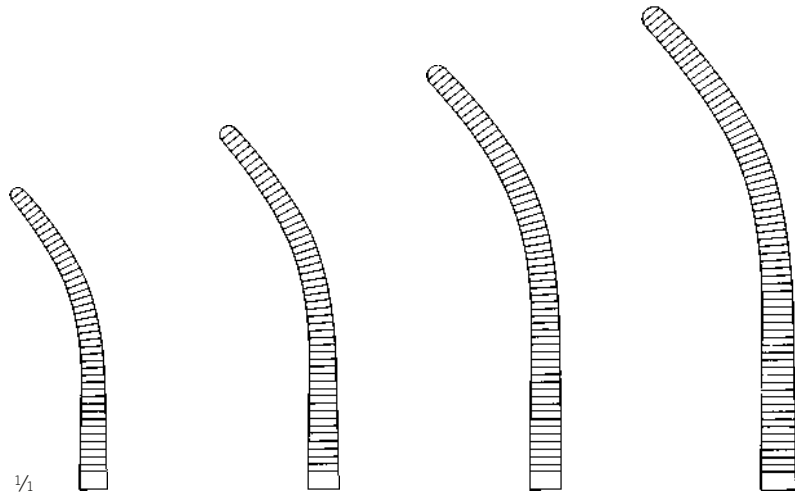

1/4

13-411-14-07  
14 cm / 5 4/8"

13-411-16-07  
16,5 cm / 6 4/8"

13-411-18-07  
18,5 cm / 7 2/8"

13-411-20-07  
20,5 cm / 8 1/8"



1/2

1/4

13-411-22-07  
22 cm / 8 5/8"

13-411-24-07  
24 cm / 9 4/8"

13-411-26-07  
26 cm / 10 2/8"

13-411-30-07  
30,5 cm / 12"

Pean (Rochester)  
13-411-14-07 -  
13-411-30-07

# Arterienklemmen

Haemostatic Forceps  
 Pinzas hemostáticas  
 Pincas hémostatiques  
 Pinze emostatiche

# Klemmen

Forceps  
 Pinzas  
 Pincas  
 Pinze



1/1



13-414-14-07  
 14,5 cm / 5 7/8"



13-414-16-07  
 16,5 cm / 6 4/8"



13-414-18-07  
 18,5 cm / 7 3/8"

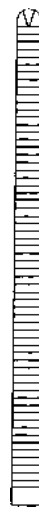

13-414-20-07  
 20,5 cm / 8 1/8"



1/2

Kocher (Ochsner)  
 13-414-14-07 -  
 13-414-30-07

1/1



13-414-22-07  
 22,5 cm / 8 7/8"

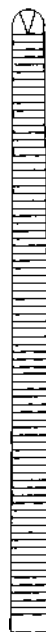

13-414-24-07  
 24 cm / 9 4/8"



13-414-26-07  
 26 cm / 10 2/8"

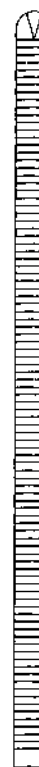

13-414-30-07  
 31 cm / 12 2/8"



## Arterienklemmen

Haemostatic Forceps

Pinzas hemostáticas

Pinces hémostatiques

Pinze emostatiche

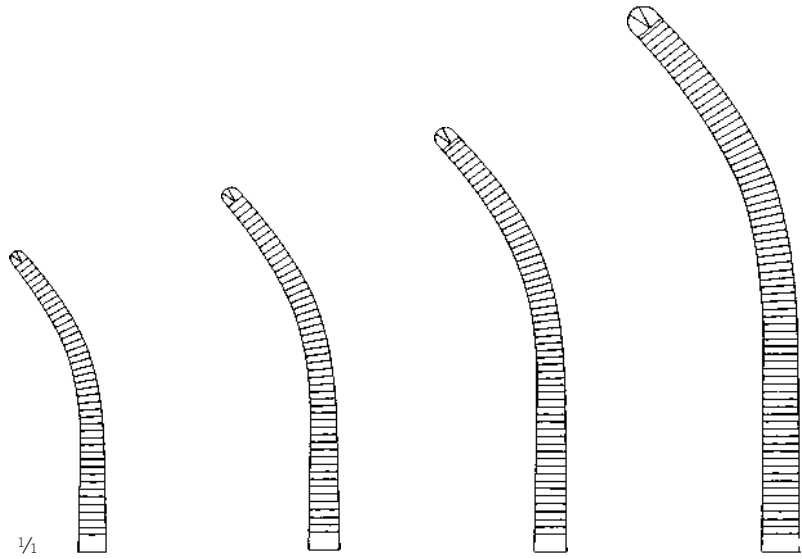

$\frac{1}{4}$

13-415-14-07

14 cm / 5  $\frac{4}{8}$ "



13-415-16-07

16,5 cm / 6  $\frac{4}{8}$ "



13-415-18-07

18,5 cm / 7  $\frac{2}{8}$ "



13-415-20-07

20 cm / 7  $\frac{7}{8}$ "



$\frac{1}{2}$

Kocher (Ochsner)

13-415-14-07 -

13-415-30-07

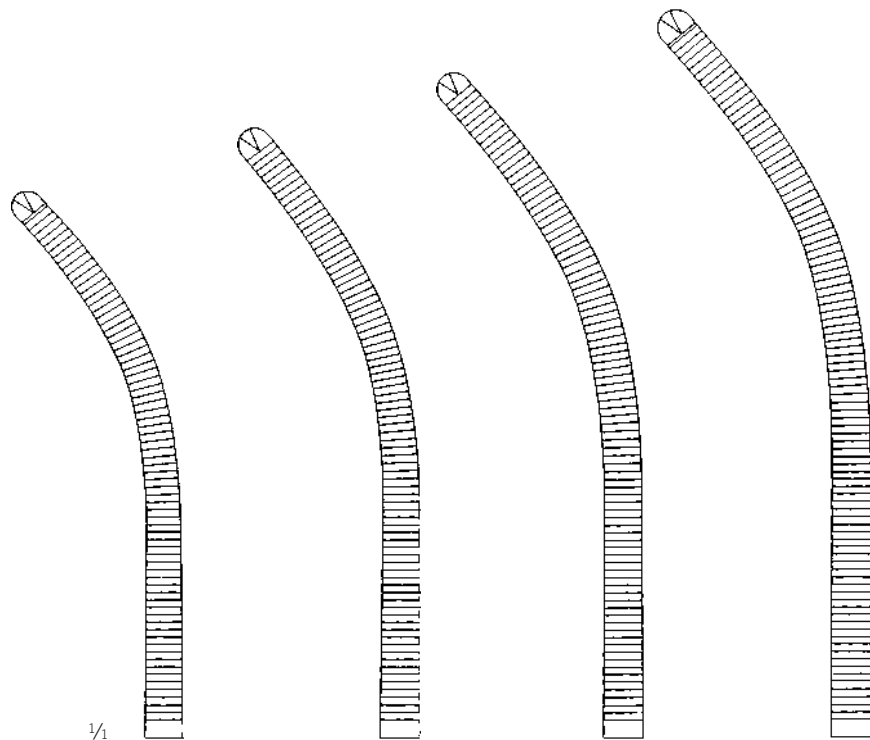

$\frac{1}{4}$

13-415-22-07

22,5 cm / 8  $\frac{7}{8}$ "



13-415-24-07

24 cm / 9  $\frac{4}{8}$ "



13-415-26-07

26 cm / 10  $\frac{2}{8}$ "



13-415-30-07

30,5 cm / 12"



## Arterienklemmen, Präparierklemmen

Haemostatic Forceps, Dissecting and Ligature Forceps  
Pinzas hemostáticas, Pinzas para preparación y ligadura  
Pincas hémostatiques, Pincas à dissecquer et à ligatures  
Pinze emostatiche, Pinze per preparazioni e legature

## Klemmen

Forceps  
Pinzas  
Pincas  
Pinze

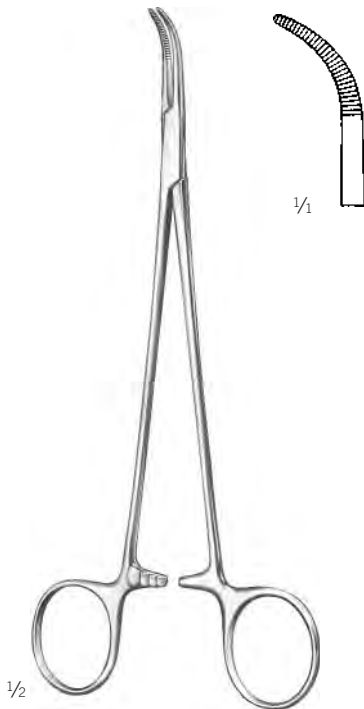

Mixer-Baby  
13-419-18-07  
18,5 cm / 7 <sup>2</sup>/<sub>8</sub>"



Adson-Baby  
13-421-14-07 -  
13-421-18-07

13-421-14-07  
14,5 cm / 5 <sup>6</sup>/<sub>8</sub>"

13-421-18-07  
18 cm / 7 <sup>1</sup>/<sub>8</sub>"

## Präparierklemmen

Dissecting and Ligature Forceps  
 Pinzas para preparación y ligadura  
 Pincas à disséquer et à ligatures  
 Pinze per preparazioni e legature

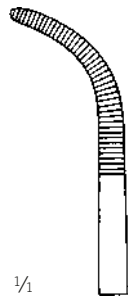

**Fig. 1**  
 13-443-01-07  
 20,5 cm / 8 1/8"

13-447-01-07  
 27 cm / 10 5/8"

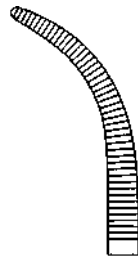

**Fig. 2**  
 13-443-02-07  
 20 cm / 7 7/8"

13-447-02-07  
 26,5 cm / 10 3/8"

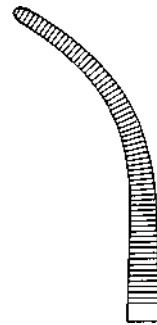

**Fig. 3**  
 13-443-03-07  
 21,5 cm / 8 4/8"

13-447-03-07  
 27,5 cm / 10 7/8"

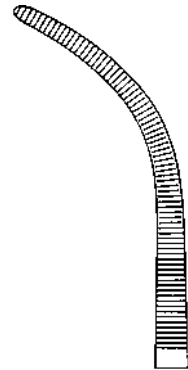

**Fig. 4**  
 13-443-04-07  
 22 cm / 8 5/8"

13-447-04-07  
 28 cm / 11"

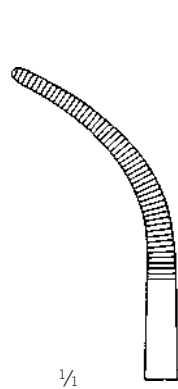

**Fig. 5**  
 13-443-05-07  
 21,5 cm / 8 4/8"

13-447-05-07  
 27,5 cm / 10 7/8"

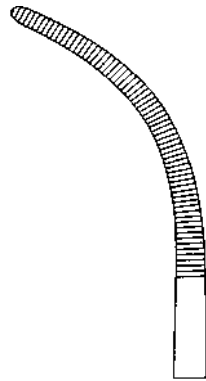

**Fig. 6**  
 13-443-06-07  
 21,5 cm / 8 5/8"

13-447-06-07  
 28 cm / 11"

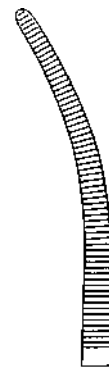

**Fig. 7**  
 13-443-07-07  
 22 cm / 8 5/8"

13-447-07-07  
 27,5 cm / 10 7/8"



Overholt-Geissendörfer  
 13-443-01-07 -  
 13-447-07-07

## Präparierklemmen

Dissecting and Ligature Forceps  
 Pinzas para preparación y ligadura  
 Pincès à disséquer et à ligatures  
 Pinze per preparazioni e legature

## Klemmen

Forceps  
 Pinzas  
 Pincès  
 Pinze



1/2

Gemini  
 13-451-13-07 -  
 13-451-28-07

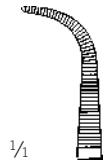

1/4

13-451-13-07  
 13 cm / 5 1/8"

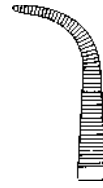

13-451-16-07  
 16 cm / 6 2/8"

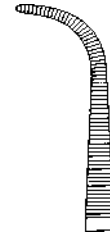

13-451-18-07  
 18 cm / 7 1/8"

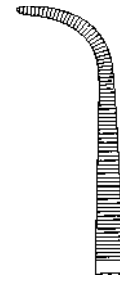

13-451-20-07  
 21 cm / 8 2/8"

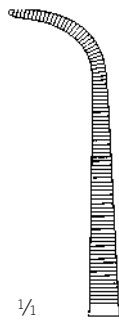

1/4

13-451-23-07  
 23 cm / 9"

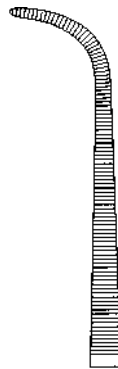

13-451-25-07  
 25 cm / 9 7/8"



13-451-28-07  
 28 cm / 11"

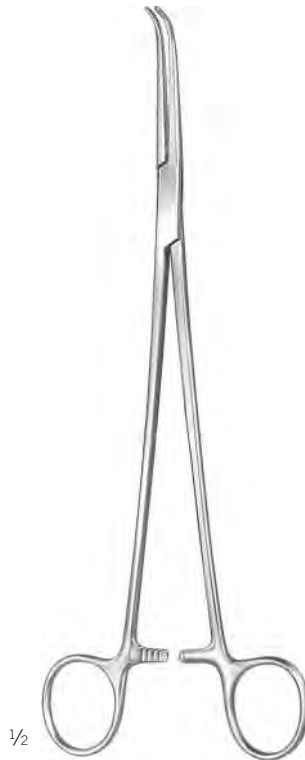

1/2

Mini-Gemini  
 13-453-18-07 -  
 13-453-28-07

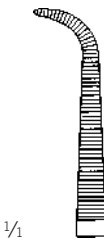

1/4

13-453-18-07  
 18 cm / 7 1/8"



13-453-22-07  
 23 cm / 9"



13-453-25-07  
 25 cm / 9 7/8"

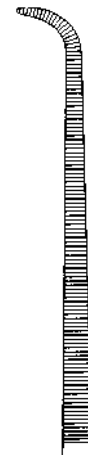

13-453-28-07  
 28,5 cm / 11 2/8"

## Tuchklemmen

Towel Clamps  
Pinzas de campo  
Pincas à champs  
Pinze fissatele

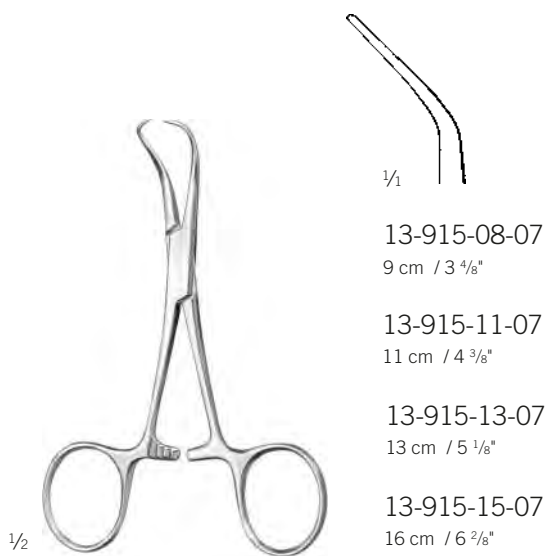

13-915-08-07  
9 cm / 3 4/8"

13-915-11-07  
11 cm / 4 3/8"

13-915-13-07  
13 cm / 5 1/8"

13-915-15-07  
16 cm / 6 2/8"

Backhaus  
13-915-08-07 -  
13-915-15-07

scharf  
sharp  
agudo  
pointu  
acuto

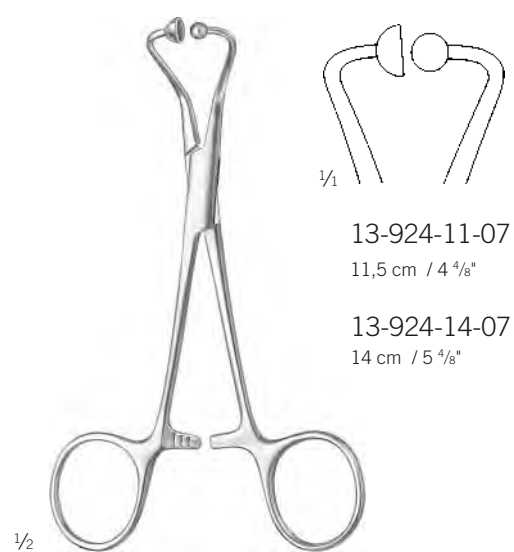

13-924-11-07  
11,5 cm / 4 4/8"

13-924-14-07  
14 cm / 5 4/8"

13-924-11-07 -  
13-924-14-07

für Papierabdeckung  
for paper drapes  
para paños de papel  
pour couverture en papier  
per copertura di carta



Wundhaken, Halte- und Spreizsysteme  
Retractors, Holding and spreading systems  
Separadores, Sistemas de sujeción y dispersión  
Ecarteurs, Systèmes de maintien et d'épandage  
Divaricatori, Sistemi di tenuta e diffusione

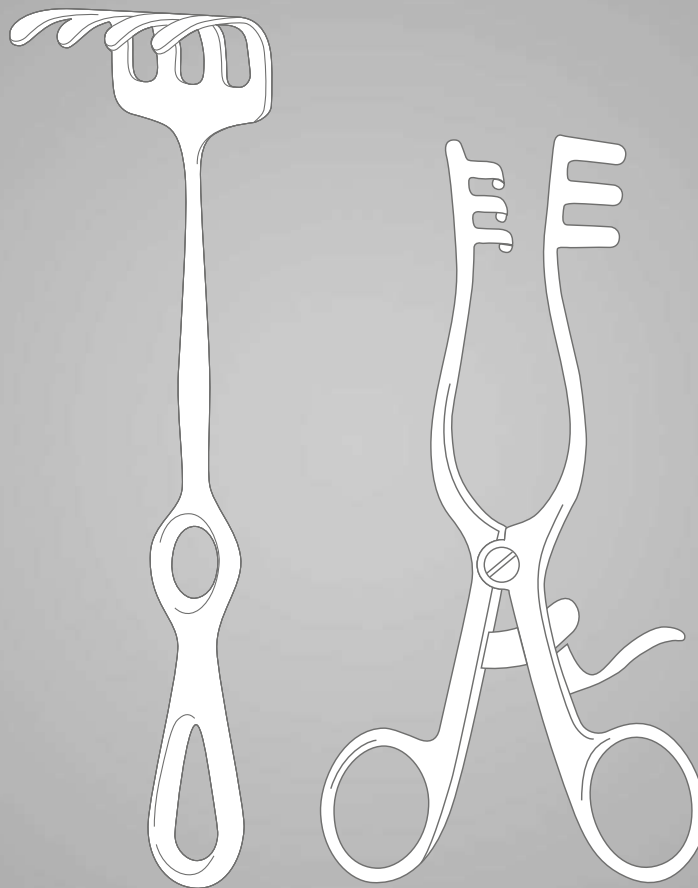

## Hauthäkchen, Wundhäkchen

Skin Hooklets, Hooklets  
 Ganchitos para piel, Ganchitos  
 Erignes cutanées, Crochetes  
 Uncini cutanei, Divaricatori



1/2

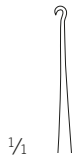

1/1

15-066-01-07

scharf  
 sharp  
 agudo  
 pointu  
 acuto



15-066-02-07

stumpf  
 blunt  
 romo  
 mousse  
 smusso

Graefe

15-066-01-07 - 15-066-02-07

15 cm / 5 7/8"



1/2

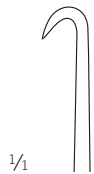

1/1

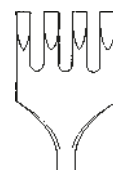

|   |              |              |              |              |
|---|--------------|--------------|--------------|--------------|
| scharf<br>sharp<br>agudo<br>pointu<br>acuto | 15-074-01-07 | 15-074-02-07 | 15-074-03-07 | 15-074-04-07 |
|---|--------------|--------------|--------------|--------------|

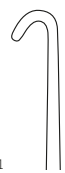

1/1

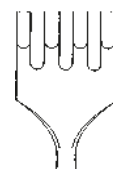
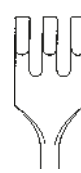

|   |              |              |              |              |
|---|--------------|--------------|--------------|--------------|
| stumpf<br>blunt<br>romo<br>mousse<br>smusso | 15-075-01-07 | 15-075-02-07 | 15-075-03-07 | 15-075-04-07 |
|---|--------------|--------------|--------------|--------------|

15-074-01-07 -

15-075-04-07

16,5 cm / 6 4/8"

## Sattelhäkchen, Wundhäkchen

Saddle Hooks, Hooklets

Ganchos en forma de silla, Ganchitos

Ecarteurs sous forme de selle, Crochetes

Divaricatori a forma di sella, Divaricatori

## Wundhaken, Halte- und Spreizsysteme

Retractors, Holding and spreading systems

Separadores, Sistemas de sujeción y dispersión

Ecarteurs, Systèmes de maintien et d'épandage

Divaricatori, Sistemi di tenuta e diffusione

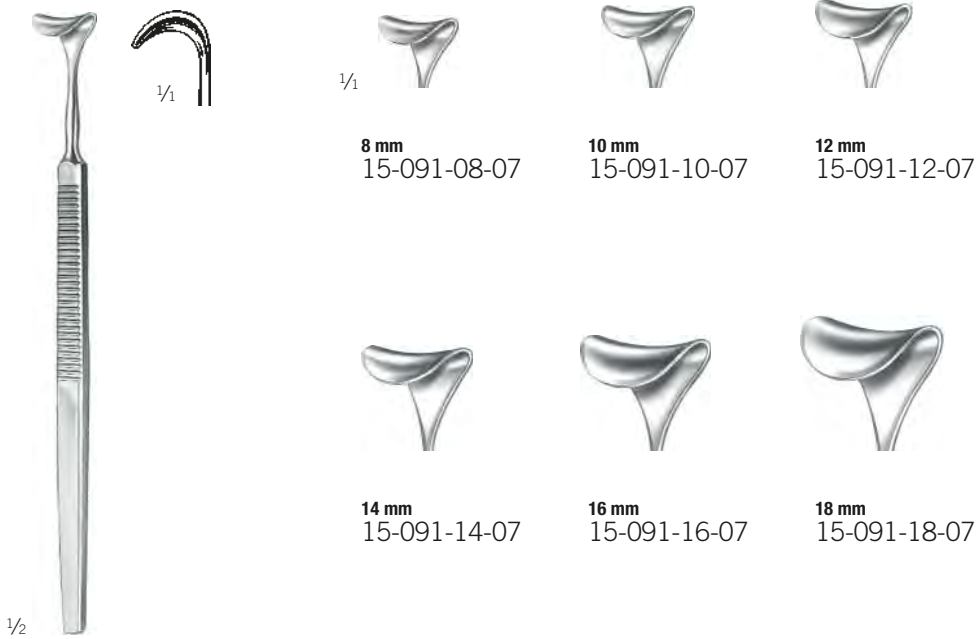

Desmarres

15-091-08-07 -

15-091-18-07

16 cm / 6 2/8"



Langenbeck-Mini

15-095-10-07 -

15-095-22-07

16 cm / 6 2/8"

# Wundhäkchen

Hooklets  
Ganchitos  
Crochetes  
Divaricatori

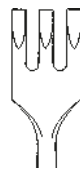
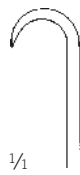

|   |              |              |              |              |
|---|--------------|--------------|--------------|--------------|
| scharf<br>sharp<br>agudo<br>pointu<br>acuto | 15-100-01-07 | 15-100-02-07 | 15-100-03-07 | 15-100-04-07 |
|---|--------------|--------------|--------------|--------------|

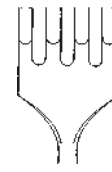

|   |              |              |              |              |
|---|--------------|--------------|--------------|--------------|
| stumpf<br>blunt<br>romo<br>mousse<br>smusso | 15-101-01-07 | 15-101-02-07 | 15-101-03-07 | 15-101-04-07 |
|---|--------------|--------------|--------------|--------------|

1/2

15-100-01-07 -  
15-101-04-07  
16,5 cm / 6 1/8"



**Fig. 1**  
15-161-01-07  
20 x 6 mm

**Fig. 2**  
15-161-02-07  
10 x 6 mm

1/2

Senn-Green  
15-161-01-07 -  
15-161-02-07  
16 cm / 6 2/8"

## Sattelhäkchen

Saddle Hooks

Ganchos en forma de silla

Ecarteurs sous forme de selle

Divaricatori a forma di sella

## Wundhaken, Halte- und Spreizsysteme

Retractors, Holding and spreading systems

Separadores, Sistemas de sujeción y dispersión

Ecarteurs, Systèmes de maintien et d'épandage

Divaricatori, Sistemi di tenuta e diffusione

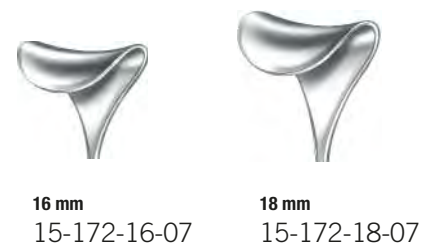
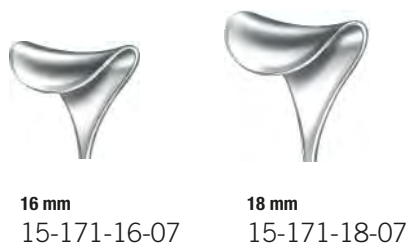
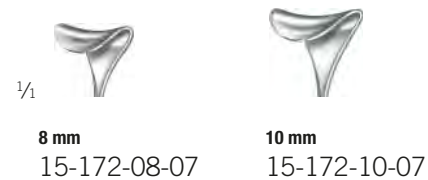
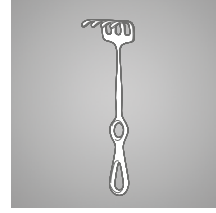

1/2

Cushing  
15-171-08-07 -  
15-171-18-07  
20,5 cm / 8 1/8"

1/2

Cushing  
15-172-08-07 -  
15-172-18-07  
24 cm / 9 4/8"

# Wundhaken

Retractors  
 Separadores  
 Ecarteurs  
 Divaricatori

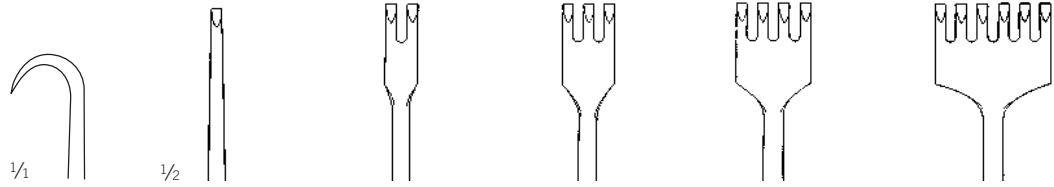

|   |              |              |              |              |              |
|---|--------------|--------------|--------------|--------------|--------------|
| scharf<br>sharp<br>agudo<br>pointu<br>acuto | 15-220-01-07 | 15-220-02-07 | 15-220-03-07 | 15-220-04-07 | 15-220-06-07 |
|---|--------------|--------------|--------------|--------------|--------------|

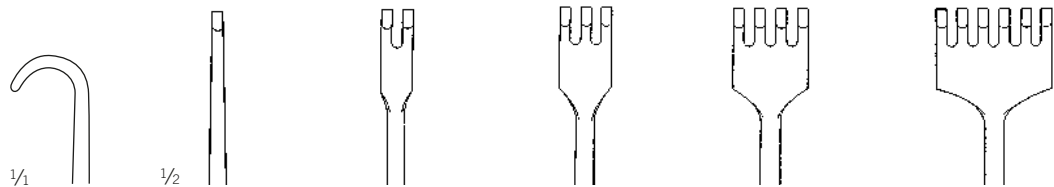

|   |              |              |              |              |              |
|---|--------------|--------------|--------------|--------------|--------------|
| stumpf<br>blunt<br>romo<br>mousse<br>smusso | 15-221-01-07 | 15-221-02-07 | 15-221-03-07 | 15-221-04-07 | 15-221-06-07 |
|---|--------------|--------------|--------------|--------------|--------------|

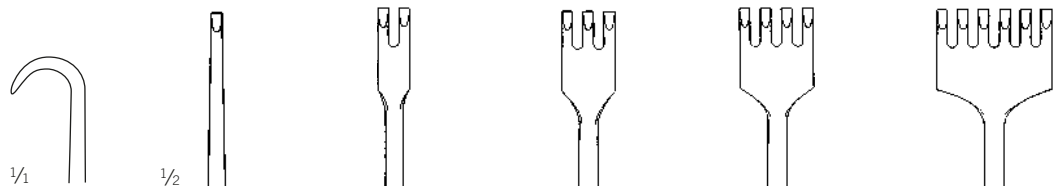

|   |              |              |              |              |              |
|---|--------------|--------------|--------------|--------------|--------------|
| halbscharf<br>semi-sharp<br>semi-agudo<br>semi-pointu<br>semi-acuto | 15-222-01-07 | 15-222-02-07 | 15-222-03-07 | 15-222-04-07 | 15-222-06-07 |
|---|--------------|--------------|--------------|--------------|--------------|



1/2

Volkman  
 15-220-01-07 -  
 15-222-06-07  
 22,5 cm / 8 7/8"

## Wundhaken

Retractors  
Separadores  
Ecarteurs  
Divaricatori

## Wundhaken, Halte- und Spreizsysteme

Retractors, Holding and spreading systems  
Separadores, Sistemas de sujeción y dispersión  
Ecarteurs, Systèmes de maintien et d'épandage  
Divaricatori, Sistemi di tenuta e diffusione

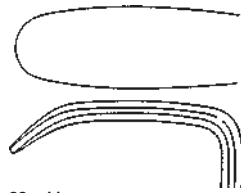

30 x 11 mm  
15-293-01-07

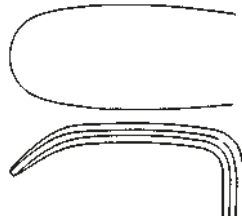

30 x 14 mm  
15-293-02-07

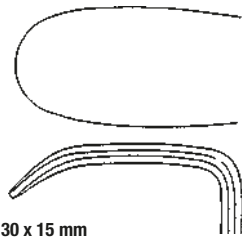

30 x 15 mm  
15-293-03-07

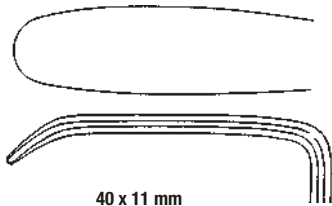

40 x 11 mm  
15-293-04-07

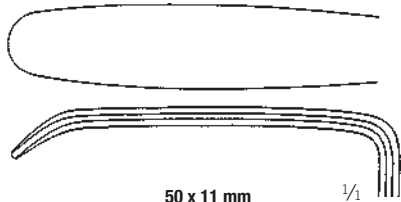

50 x 11 mm <sup>1/1</sup>  
15-293-05-07



<sup>1/2</sup>

Langenbeck  
15-293-01-07 -  
15-293-05-07  
22 cm / 8 <sup>5/8</sup>"

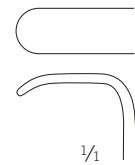

<sup>1/1</sup>

6 x 16 mm  
15-301-16-07

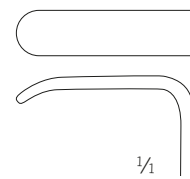

<sup>1/1</sup>

6 x 25 mm  
15-301-25-07



<sup>1/2</sup>

Langenbeck-Green  
15-301-16-07 -  
15-301-25-07  
16 cm / 6 <sup>2/8</sup>"

## Wundhaken

Retractors  
Separadores  
Ecarteurs  
Divaricatori



1/2

Kocher-Langenbeck  
15-317-01-07 -  
15-317-09-07  
21,5 cm / 8 4/8"

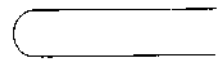

25 x 6 mm  
15-317-01-07

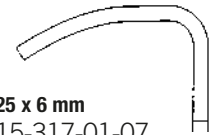

35 x 8 mm  
15-317-02-07

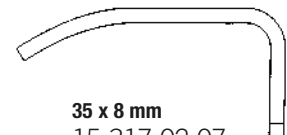

35 x 11 mm  
15-317-03-07

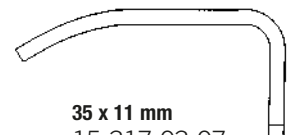

35 x 15 mm  
15-317-04-07



40 x 11 mm  
15-317-05-07

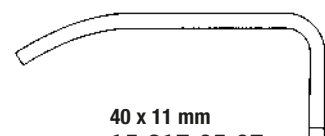

55 x 11 mm  
15-317-06-07

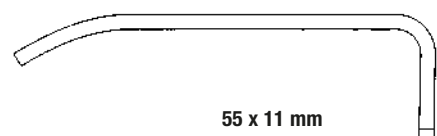

70 x 14 mm  
15-317-07-07

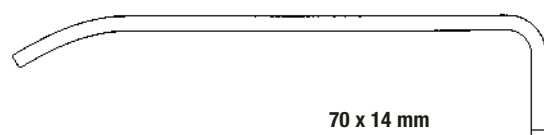

80 x 13 mm  
15-317-08-07

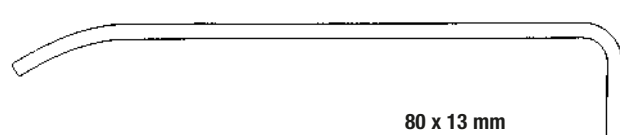

80 x 16 mm  
15-317-09-07

1/4



## Wundhaken

Retractors  
Separadores  
Ecarteurs  
Divaricatori

## Wundhaken, Halte- und Spreizsysteme

Retractors, Holding and spreading systems  
Separadores, Sistemas de sujeción y dispersión  
Ecarteurs, Systèmes de maintien et d'épandage  
Divaricatori, Sistemi di tenuta e diffusione



Roux  
15-655-00-01 -  
15-655-03-01

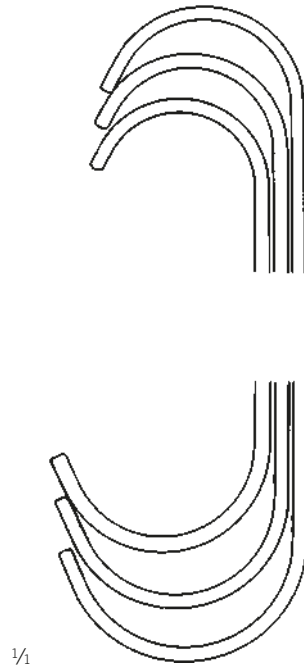

**Fig. 1 - 3**  
15-655-00-01  
17 cm / 6 5/8"  
Satz  
Set

**Fig. 1**

22 x 21 mm  
27 x 29 mm  
15-655-01-01  
14,5 cm / 5 7/8"

**Fig. 2**

25 x 26 mm  
30 x 38 mm  
15-655-02-01  
16 cm / 6 2/8"

**Fig. 3**

28 x 29 mm  
33 x 43 mm  
15-655-03-01  
17 cm / 6 5/8"

# Haken

Hooks  
Ganchos  
Crochets  
Uncini

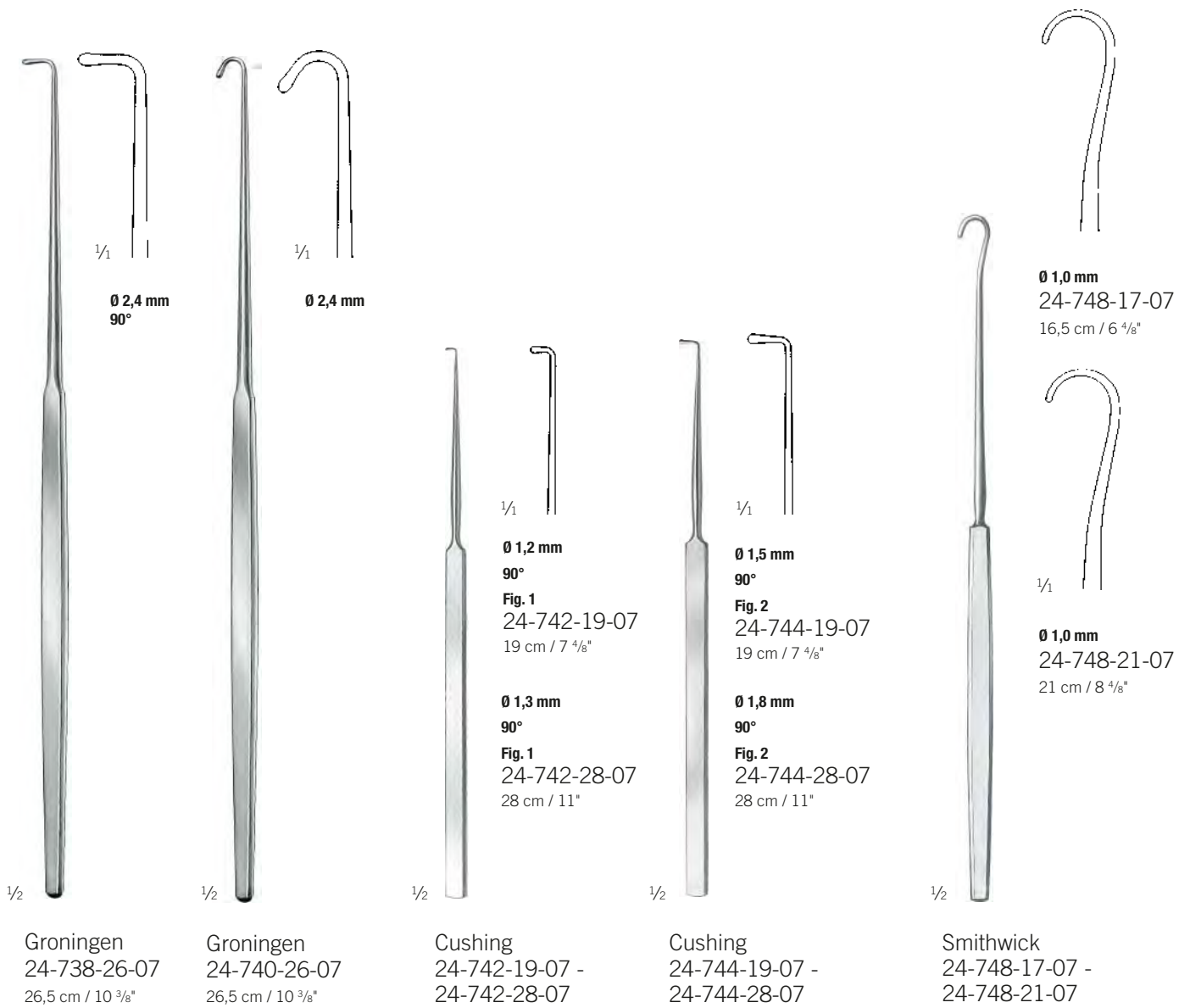

# Haken

Hooks  
Ganchos  
Crochets  
Uncini

# Wundhaken, Halte- und Spreizsysteme

Retractors, Holding and spreading systems  
Separadores, Sistemas de sujeción y dispersión  
Ecarteurs, Systèmes de maintien et d'épandage  
Divaricatori, Sistemi di tenuta e diffusione



|   |  |  |   |   |   |   |   |  |  |  |
|---|--|--|---|---|---|---|---|--|--|--|
| <br>1/4 | <br>1/4 | <br>1/4 | <br>1/2 | <br>1/4 | <br>1/2 | <br>1/4 | <br>1/2 | <br>1/4 | <br>1/4 |  |
| 24-823-20-07<br>stumpf<br>blunt<br>romo<br>mousse<br>smusso                               |  | 24-824-20-07<br>scharf<br>sharp<br>agudo<br>pointu<br>acuto                              |   |   |   |   | 24-835-13-07<br>13 cm / 5 1/8"  | 24-835-18-07<br>18 cm / 7 1/8"   |  |  |
| Adson<br>24-823-20-07-<br>24-824-20-07<br>20 cm / 7 7/8"                                  |  | Graham<br>24-825-16-07<br>16,5 cm / 6 4/8"   |   |   | Sachs<br>24-827-18-07<br>17 cm / 6 6/8"   |   | Frazier<br>24-835-13-07 -<br>24-835-18-07   |  |  |  |

## Nasenhäkchen, Schleimhauthäkchen

Nasal Hooklets, Mucosa Hooklet

Ganchitos nasales, Ganchito para mucosa

Crochets nasaux, Crochet pour la muqueuse

Uncini nasali, Uncino per mucosa



Joseph  
37-684-15-07

15,5 cm / 6 1/8"

Schleimhauthäkchen, scharf  
Mucosa hooklet, sharp  
Ganchito para mucosa, agudo  
Crochet pour la muqueuse, pointu  
Uncino per mucosa, acuto

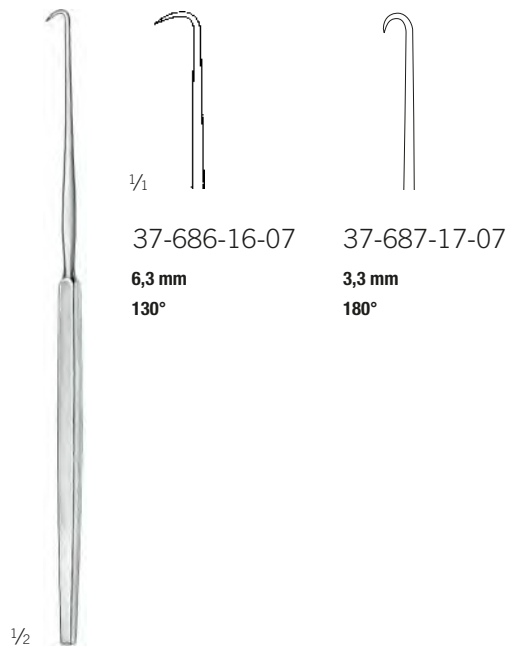

Cottle  
37-686-16-07 - 37-687-17-07

17 cm / 6 1/8"

scharf  
sharp  
agudo  
pointu  
acuto



Freer  
37-702-15-07

15 cm / 5 7/8"

scharf  
sharp  
agudo  
pointu  
acuto

## Schleimhauthäkchen

Mucosa Hooklet

Ganchito para mucosa

Crochet pour la muqueuse

Uncino per mucosa

## Wundhaken, Halte- und Spreizsysteme

Retractors, Holding and spreading systems

Separadores, Sistemas de sujeción y dispersión

Ecarteurs, Systèmes de maintien et d'épandage

Divaricatori, Sistemi di tenuta e diffusione



1/1



37-704-02-07

2 mm



37-704-05-07

5 mm

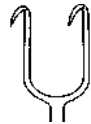

37-704-07-07

7 mm

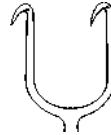

37-704-10-07

10 mm

1/2

Joseph

37-704-02-07 - 37-704-10-07

16 cm / 6 1/8"

## Wundspreizer, selbsthaltend

Wound Spreaders, self-retaining

Separadores autoestáticos

Ecarteurs autostatiques

Divaricatori autostatici

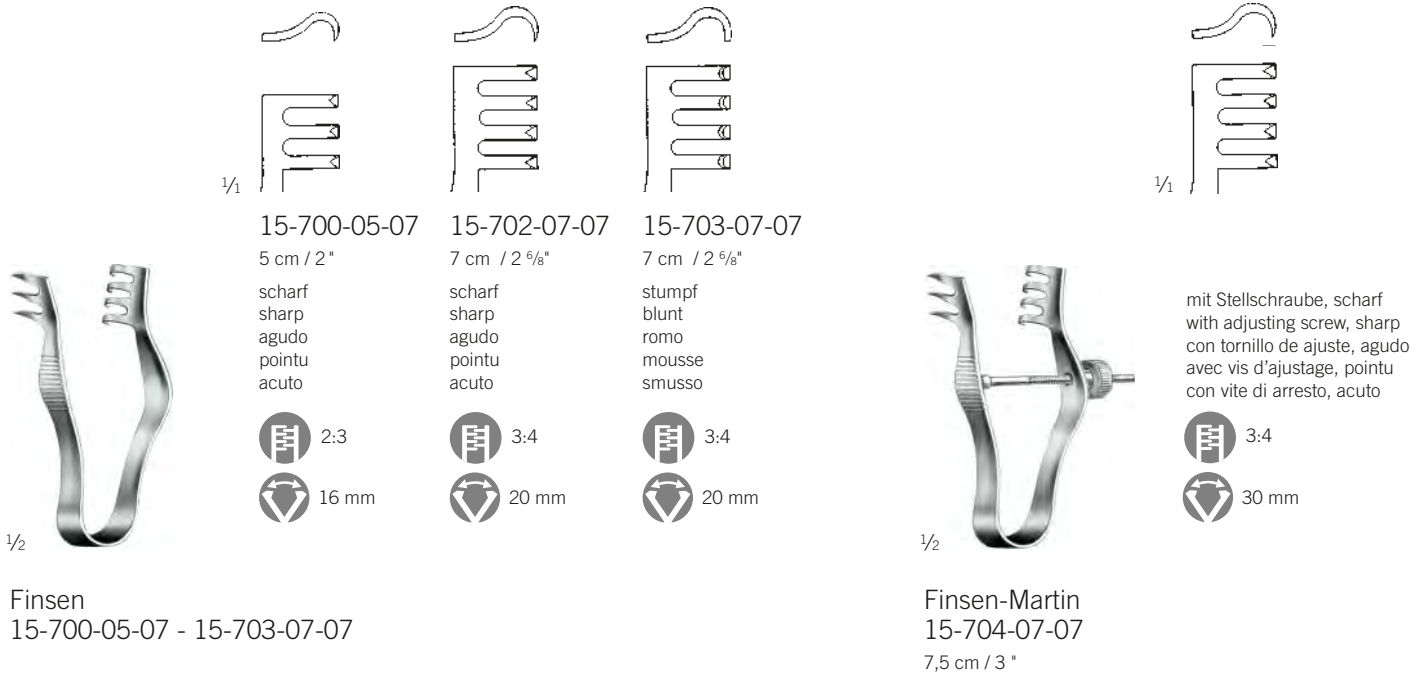

Finsen  
15-700-05-07 - 15-703-07-07

Finsen-Martin  
15-704-07-07  
7,5 cm / 3"

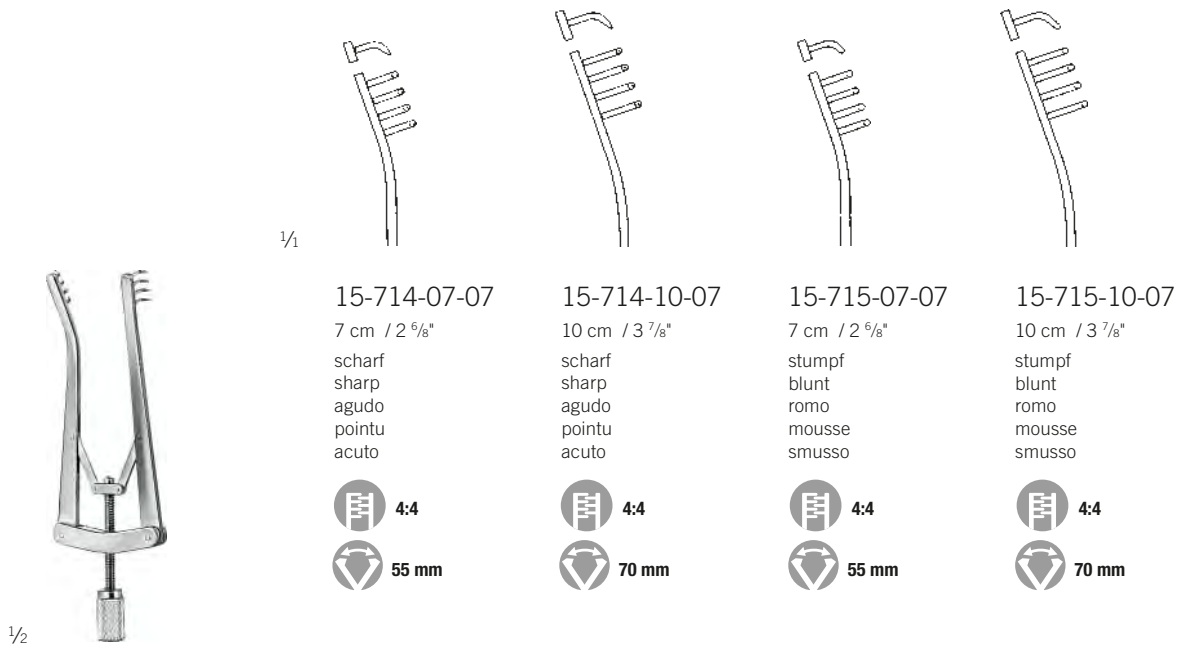

Alm  
15-714-07-07 -  
15-715-10-07

mit Stellschraube  
with adjusting screw  
con tornillo de ajuste  
avec vis d'ajustage  
con vite di arresto

## Wundspreizer, selbsthaltend

Wound Spreaders, self-retaining

Separadores autoestáticos

Ecarteurs autostatiques

Divaricatori autostatici

## Wundhaken, Halte- und Spreizsysteme

Retractors, Holding and spreading systems

Separadores, Sistemas de sujeción y dispersión

Ecarteurs, Systèmes de maintien et d'épandage

Divaricatori, Sistemi di tenuta e diffusione

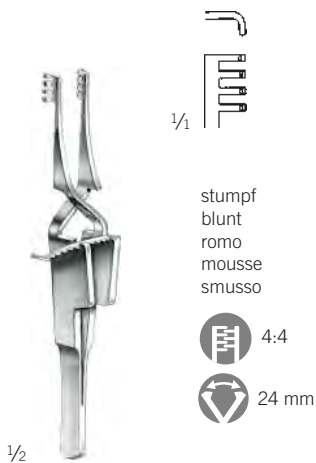

15-717-10-07  
10 cm / 3 7/8"

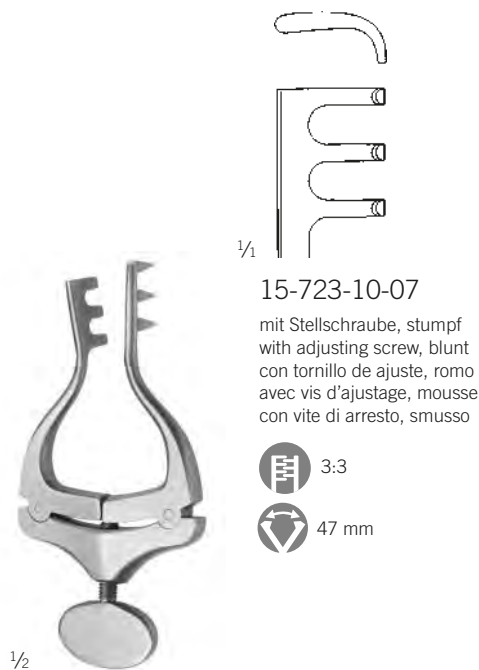

Jansen  
15-723-10-07 - 15-723-20-07  
10 cm / 3 7/8"

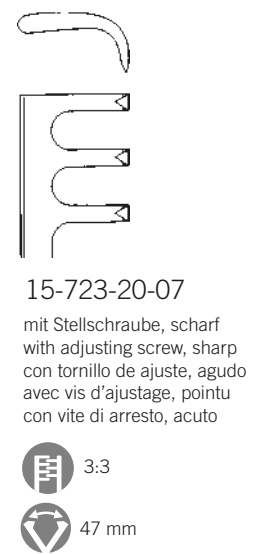

15-723-20-07  
mit Stellschraube, scharf  
with adjusting screw, sharp  
con tornillo de ajuste, agudo  
avec vis d'ajustage, pointu  
con vite di arresto, acuto

## Wundspreizer, selbsthaltend

Wound Spreaders, self-retaining

Separadores autoestáticos

Ecarteurs autostatiques

Divaricatori autostatici



1/2

Scalp-Contour  
15-725-14-07 -  
15-727-14-07  
13,5 cm / 5 3/8"

1/4

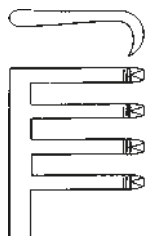

15-725-14-07

13,5 cm / 5 3/8"

scharf  
sharp  
agudo  
pointu  
acuto

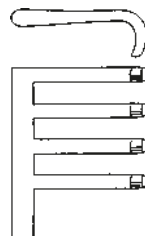
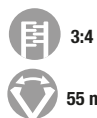

15-727-14-07

13,5 cm / 5 3/8"

stumpf  
blunt  
romo  
mousse  
smusso

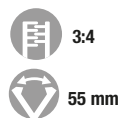



## Wundspreizer, selbsthaltend

Wound Spreaders, self-retaining

Separadores autoestáticos

Ecarteurs autostatiques

Divaricatori autostatici

## Wundhaken, Halte- und Spreizsysteme

Retractors, Holding and spreading systems

Separadores, Sistemas de sujeción y dispersión

Ecarteurs, Systèmes de maintien et d'épandage

Divaricatori, Sistemi di tenuta e diffusione

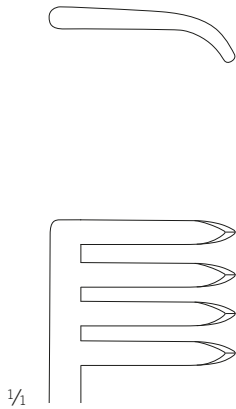

1/4

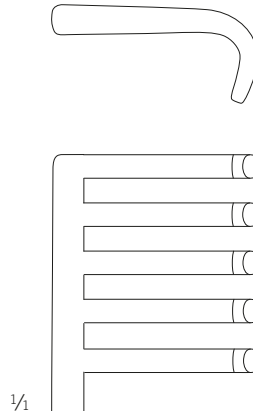

1/4

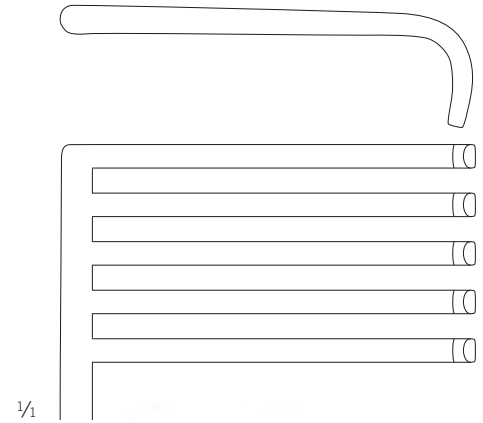

1/4



1/2

Anderson-Adson  
15-732-20-07

19 cm / 7 4/8"

scharf  
sharp  
agudo  
pointu  
acuto



4:4



84 mm



1/2

Travers  
15-733-21-07

21,5 cm / 8 4/8"

stumpf  
blunt  
romo  
mousse  
smusso



4:5



95 mm



1/2

Norfolk-Norwich  
15-733-22-07

22 cm / 8 5/8"

stumpf  
blunt  
romo  
mousse  
smusso



4:5



110 mm

## Wundspreizer, selbsthaltend

Wound Spreaders, self-retaining

Separadores autoestáticos

Ecarteurs autostatiques

Divaricatori autostatici

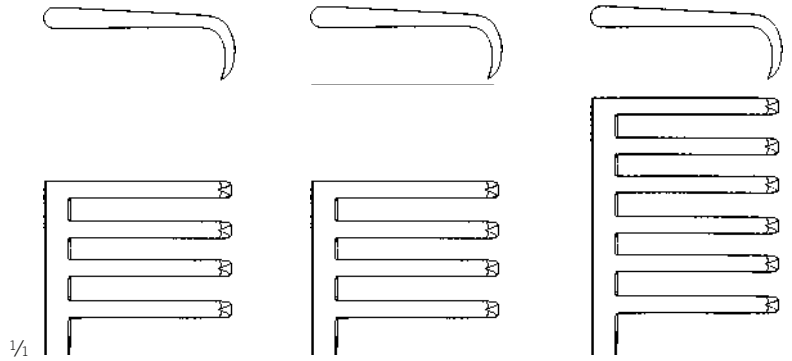

|   |  |   |   |               |
|---|--|---|---|---------------|
| scharf<br>sharp<br>agudo<br>pointu<br>acuto |  | 15-734-20-07                            | 15-734-24-07                            | 15-734-26-07  |
|   |  | 20 cm / 7 <sup>7</sup> / <sub>8</sub> " | 24 cm / 9 <sup>4</sup> / <sub>8</sub> " | 25,5 cm / 10" |
|   |  | 3:4                                     | 3:4                                     | 5:6           |
|   |  | 90 mm                                   | 90 mm                                   | 90 mm         |

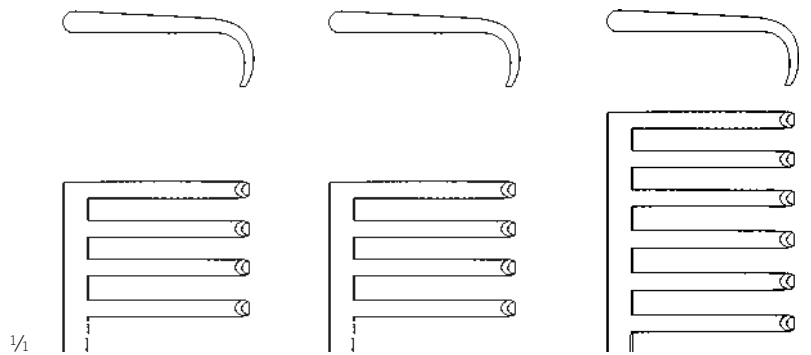

|   |  |   |   |               |
|---|--|---|---|---------------|
| stumpf<br>blunt<br>romo<br>mousse<br>smusso |  | 15-735-20-07                            | 15-735-24-07                            | 15-735-26-07  |
|   |  | 20 cm / 7 <sup>7</sup> / <sub>8</sub> " | 24 cm / 9 <sup>4</sup> / <sub>8</sub> " | 25,5 cm / 10" |
|   |  | 3:4                                     | 3:4                                     | 5:6           |
|   |  | 90 mm                                   | 90 mm                                   | 90 mm         |

Weitlaner  
15-734-20-07 -  
15-735-26-07

## Wundspreizer, selbsthaltend

Wound Spreaders, self-retaining

Separadores autoestáticos

Ecarteurs autostatiques

Divaricatori autostatici

## Wundhaken, Halte- und Spreizsysteme

Retractors, Holding and spreading systems

Separadores, Sistemas de sujeción y dispersión

Ecarteurs, Systèmes de maintien et d'épandage

Divaricatori, Sistemi di tenuta e diffusione

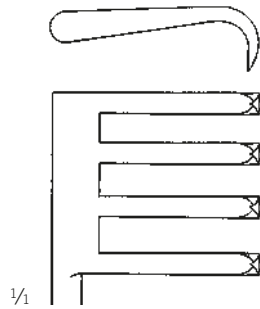

1/2

15-736-26-07

26 cm / 10 3/8"

scharf

sharp

agudo

pointu

acuto



3:4



100 mm

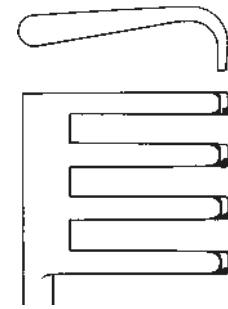

15-737-26-07

26 cm / 10 3/8"

stumpf

blunt

romo

mousse

smusso



3:4



100 mm



1/2

Adson

15-736-26-07 -

15-739-26-07

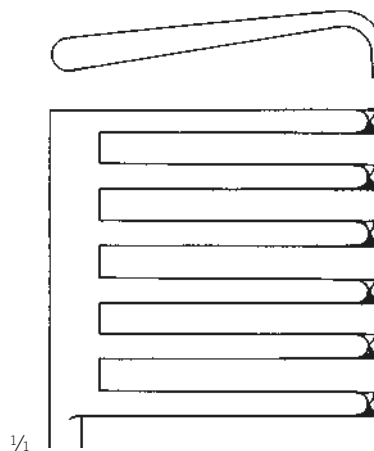

1/2

15-738-26-07

29 cm / 11 3/8"

scharf

sharp

agudo

pointu

acuto



6:6



110 mm

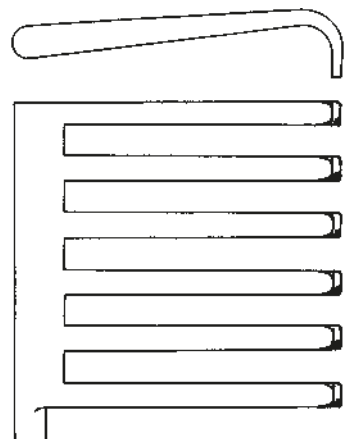

15-739-26-07

29 cm / 11 3/8"

stumpf

blunt

romo

mousse

smusso



6:6



110 mm

## Wundspreizer, selbsthaltend

Wound Spreaders, self-retaining

Separadores autoestáticos

Ecarteurs autostatiques

Divaricatori autostatici

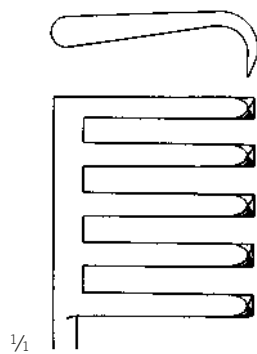

15-738-25-07

scharf  
sharp  
agudo  
pointu  
acuto



5:6



110 mm



15-739-25-07

stumpf  
blunt  
romo  
mousse  
smusso



5:6



110 mm

15-738-25-07 -  
15-739-25-07  
25,5 cm / 10"

## Wundspreizer, selbsthaltend

Wound Spreaders, self-retaining

Separadores autoestáticos

Ecarteurs autostatiques

Divaricatori autostatici

## Wundhaken, Halte- und Spreizsysteme

Retractors, Holding and spreading systems

Separadores, Sistemas de sujeción y dispersión

Ecarteurs, Systèmes de maintien et d'épandage

Divaricatori, Sistemi di tenuta e diffusione

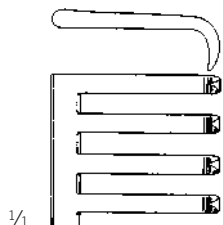
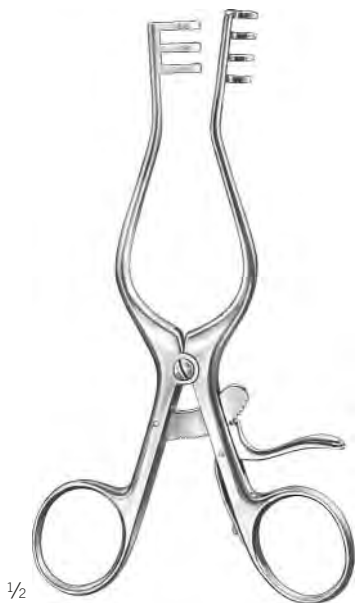

15-740-13-07

scharf  
sharp  
agudo  
pointu  
acuto



3:4



43 mm

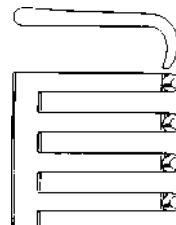

15-741-13-07

stumpf  
blunt  
romo  
mousse  
smusso



3:4



43 mm

15-740-13-07 -  
15-741-13-07

13,5 cm / 5 3/8"

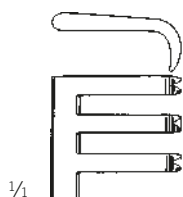

15-748-10-07

scharf  
sharp  
agudo  
pointu  
acuto



2:3



40 mm

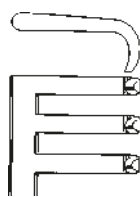

15-749-10-07

stumpf  
blunt  
romo  
mousse  
smusso



2:3



40 mm

Weitlaner  
15-748-10-07 -  
15-749-10-07

11 cm / 4 3/8"

## Wundspreizer, selbsthaltend

Wound Spreaders, self-retaining

Separadores autoestáticos

Ecarteurs autostatiques

Divaricatori autostatici

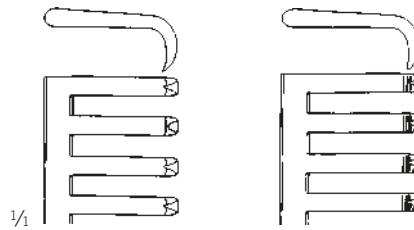

|   |  |                  |                |
|---|--|------------------|----------------|
| scharf<br>sharp<br>agudo<br>pointu<br>acuto |  | 15-750-13-07     | 15-750-16-07   |
|   |  | 13,5 cm / 5 3/8" | 16 cm / 6 2/8" |
|   |  | 43 mm            | 83 mm          |
|   |  | 3:4              | 3:4            |

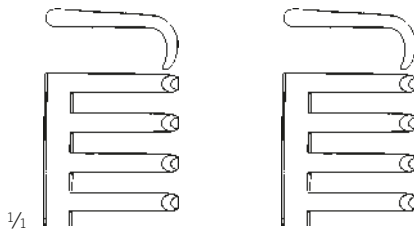

|   |  |                  |                |
|---|--|------------------|----------------|
| stumpf<br>blunt<br>romo<br>mousse<br>smusso |  | 15-751-13-07     | 15-751-16-07   |
|   |  | 13,5 cm / 5 3/8" | 16 cm / 6 2/8" |
|   |  | 43 mm            | 83 mm          |
|   |  | 3:4              | 3:4            |

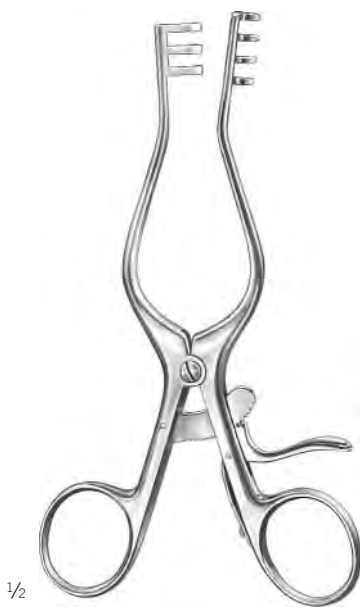

1/2

Weitlaner  
15-750-13-07 -  
15-751-16-07

## Wundspreizer, selbsthaltend

Wound Spreaders, self-retaining

Separadores autoestáticos

Ecarteurs autostatiques

Divaricatori autostatici

## Wundhaken, Halte- und Spreizsysteme

Retractors, Holding and spreading systems

Separadores, Sistemas de sujeción y dispersión

Ecarteurs, Systèmes de maintien et d'épandage

Divaricatori, Sistemi di tenuta e diffusione



1/2

Weitlaner-Wullstein

15-752-13-07 -

15-753-13-07

13 cm / 5 1/8"

1/4

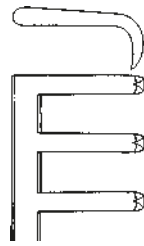

15-752-13-07

scharf  
sharp  
agudo  
pointu  
acuto



3:3



40 mm

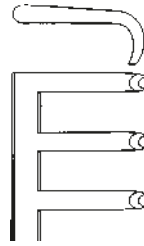

15-753-13-07

stumpf  
blunt  
romo  
mousse  
smusso



3:3



40 mm



1/2

Mollison

15-754-15-07

15,5 cm / 6 1/8"

1/4

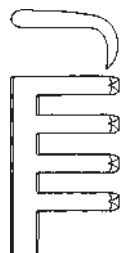

scharf  
sharp  
agudo  
pointu  
acuto



4:4



80 mm

## Wundspreizer, selbsthaltend

Wound Spreaders, self-retaining

Separadores autoestáticos

Ecarteurs autostatiques

Divaricatori autostatici

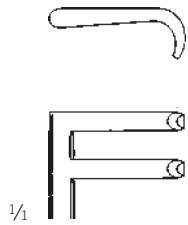

15-755-13-07

stumpf  
blunt  
romo  
mousse  
smusso



2:2



37 mm

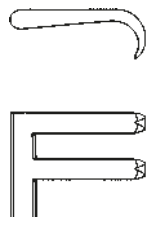

15-756-13-07

scharf  
sharp  
agudo  
pointu  
acuto



2:2



37 mm

Plester  
15-755-13-07 -  
15-756-13-07  
13 cm / 5 1/8"

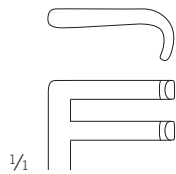

Plester  
15-757-11-07  
10,5 cm / 4 1/8"

stumpf  
blunt  
romo  
mousse  
smusso



37 mm

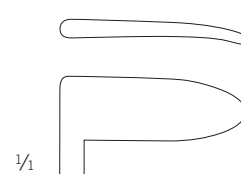

Plester  
15-759-11-07  
10,5 cm / 4 1/8"

stumpf  
blunt  
romo  
mousse  
smusso



37 mm



## Wundspreizer, selbsthaltend

Wound Spreaders, self-retaining

Separadores autoestáticos

Ecarteurs autostatiques

Divaricatori autostatici

## Wundhaken, Halte- und Spreizsysteme

Retractors, Holding and spreading systems

Separadores, Sistemas de sujeción y dispersión

Ecarteurs, Systèmes de maintien et d'épandage

Divaricatori, Sistemi di tenuta e diffusione

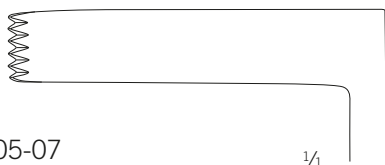

15-762-05-07

1/4

**50 x 10 mm**

Valve links voll

Blade left full

Valva a la izquierda plena

Valve sur le bras à gauche

Valva sul braccio sinistro

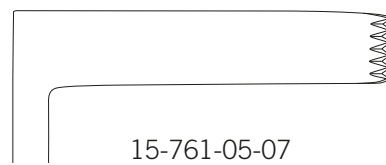

1/4

15-761-05-07

**50 x 10 mm**

Valve rechts voll

Blade rightfull

Valva a la derecha plena

Valve sur le bras à droite

Valva sul braccio destro

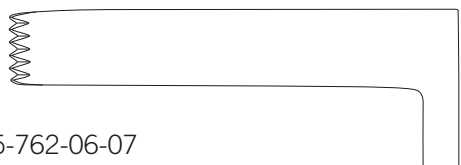

15-762-06-07

**60 x 10 mm**

Valve links voll

Blade left full

Valva a la izquierda plena

Valve sur le bras à gauche

Valva sul braccio sinistro

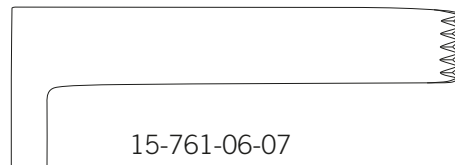

15-761-06-07

**60 x 10 mm**

Valve rechts voll

Blade rightfull

Valva a la derecha plena

Valve sur le bras à droite

Valva sul braccio destro

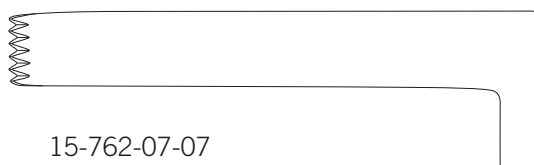

15-762-07-07

**70 x 10 mm**

Valve links voll

Blade left full

Valva a la izquierda plena

Valve sur le bras à gauche

Valva sul braccio sinistro

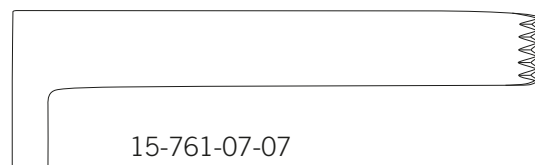

15-761-07-07

**70 x 10 mm**

Valve rechts voll

Blade rightfull

Valva a la derecha plena

Valve sur le bras à droite

Valva sul braccio destro



1/2

Williams

15-761-05-07 -

15-762-07-07

17 cm / 6 5/8"

## Wundspreizer, selbsthaltend

Wound Spreaders, self-retaining

Separadores autoestáticos

Ecarteurs autostatiques

Divaricatori autostatici

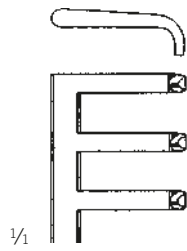

stumpf  
blunt  
romo  
mousse  
smusso



3:3



40 mm

1/2

Milligan  
15-765-13-07  
13,5 cm / 5 3/8"

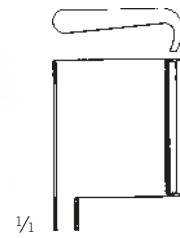
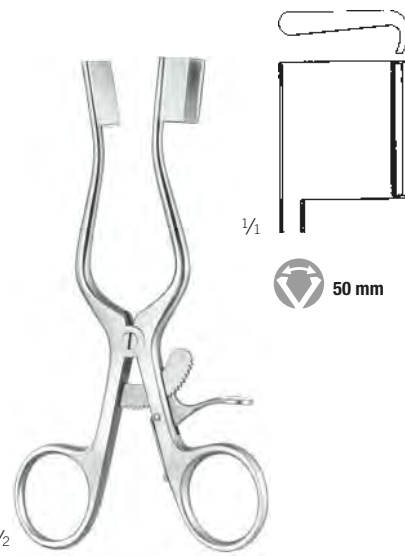

50 mm

1/2

Weitlaner-Baby  
15-767-13-07  
13,5 cm / 5 3/8"

## Wundspreizer, selbsthaltend, Mittelvalven

Wound Spreaders, self-retaining, Central Blades

Separadores autoestáticos, valvas centrales

Ecarteurs autostatiques, valves centrales

Divaricatori autostatici, valve centrali

## Wundhaken, Halte- und Spreizsysteme

Retractors, Holding and spreading systems

Separadores, Sistemas de sujeción y dispersión

Ecarteurs, Systèmes de maintien et d'épandage

Divaricatori, Sistemi di tenuta e diffusione

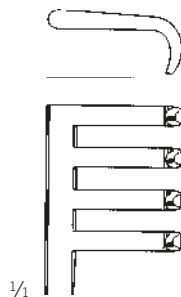

1/1

15-768-00-07



3:4

stumpf  
blunt  
romo  
mousse  
smusso

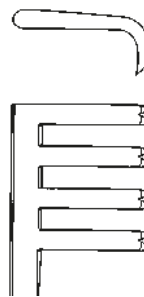

1/1

15-769-00-07



3:4

scharf  
sharp  
agudo  
pointu  
acuto



1/2

Henley  
15-768-00-07 -  
15-769-00-07

16,5 cm / 6 4/8"

85 mm

komplett mit 3 Mittelvalven  
Art.-Nr. 15-768-19-07, 15-768-25-07 und 15-768-32-07

complete with 3 central blades  
ref. 15-768-19-07, 15-768-25-07 and 15-768-32-07

completo con 3 valvas centrales  
ref. 15-768-19-07, 15-768-25-07 y 15-768-32-07

complet avec 3 valves centrales  
réf. 15-768-19-07, 15-768-25-07 et 15-768-32-07

completo con 3 valve centrali  
rif. 15-768-19-07, 15-768-25-07 e 15-768-32-07



1/2

15-768-19-07

19 x 17 mm



15-768-25-07

25 x 17 mm



15-768-32-07

32 x 17 mm

## Wundspreizer, selbsthaltend

Wound Spreaders, self-retaining

Separadores autoestáticos

Ecarteurs autostatiques

Divaricatori autostatici

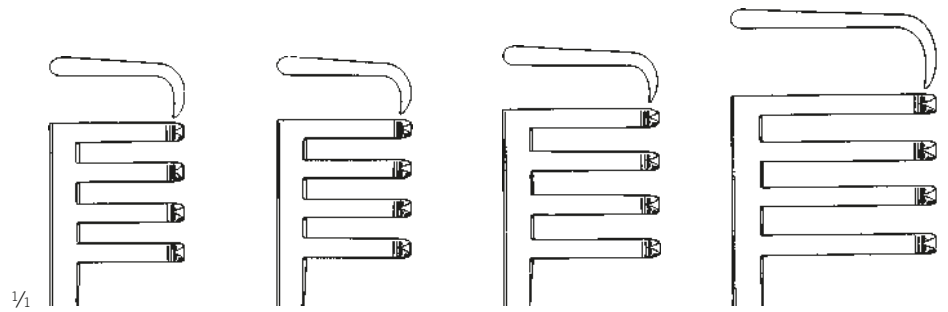

|   |  |                |                  |                |                  |
|---|--|----------------|------------------|----------------|------------------|
| scharf<br>sharp<br>agudo<br>pointu<br>acuto |  | 15-770-13-07   | 15-770-16-07     | 15-770-20-07   | 15-770-26-07     |
|   |  | 14 cm / 5 4/8" | 16,5 cm / 6 4/8" | 21 cm / 8 2/8" | 24,5 cm / 9 5/8" |
|   |  | <b>81 mm</b>   | <b>90 mm</b>     | <b>135 mm</b>  | <b>135 mm</b>    |
|   |  | <b>3:4</b>     | <b>3:4</b>       | <b>3:4</b>     | <b>3:4</b>       |

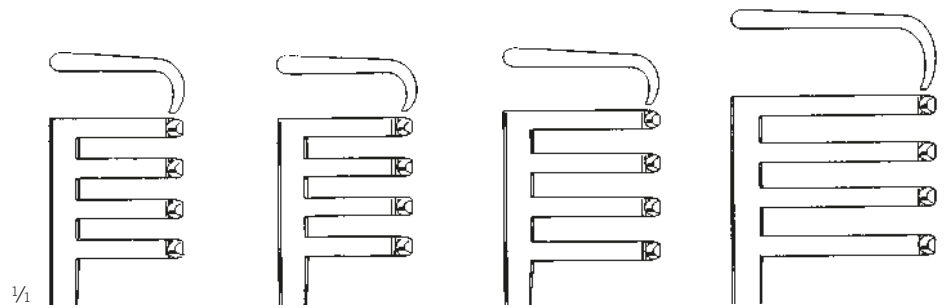

|   |  |                |                  |                |                  |
|---|--|----------------|------------------|----------------|------------------|
| stumpf<br>blunt<br>romo<br>mousse<br>smusso |  | 15-771-13-07   | 15-771-16-07     | 15-771-20-07   | 15-771-26-07     |
|   |  | 14 cm / 5 4/8" | 16,5 cm / 6 4/8" | 21 cm / 8 2/8" | 24,5 cm / 9 5/8" |
|   |  | <b>81 mm</b>   | <b>90 mm</b>     | <b>135 mm</b>  | <b>135 mm</b>    |
|   |  | <b>3:4</b>     | <b>3:4</b>       | <b>3:4</b>     | <b>3:4</b>       |

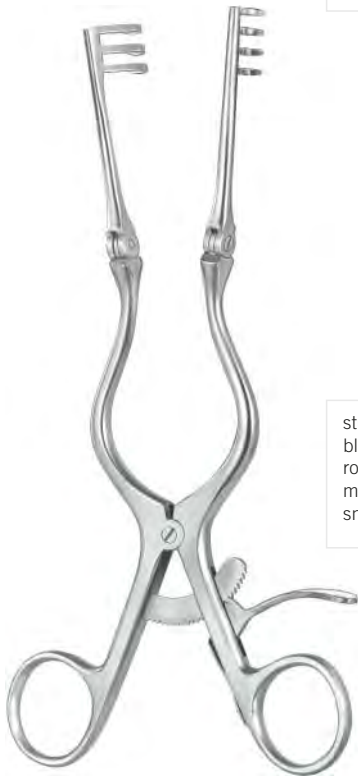

1/2

Adson  
15-770-13-07 -  
15-772-26-07

## Wundspreizer, selbsthaltend

Wound Spreaders, self-retaining

Separadores autoestáticos

Ecarteurs autostatiques

Divaricatori autostatici

## Wundhaken, Halte- und Spreizsysteme

Retractors, Holding and spreading systems

Separadores, Sistemas de sujeción y dispersión

Ecarteurs, Systèmes de maintien et d'épandage

Divaricatori, Sistemi di tenuta e diffusione

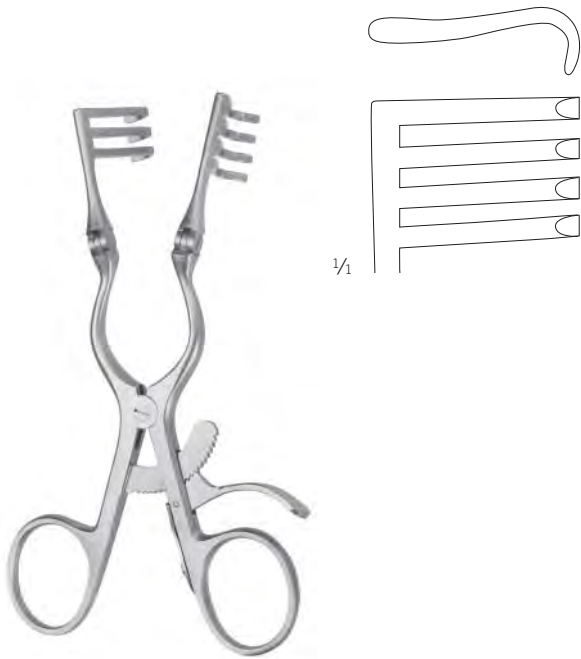

Adson  
15-773-13-07

13 cm / 5 1/8"

stumpf  
blunt  
romo  
mousse  
smusso



3:4



60 mm

## Wundspreizer, selbsthaltend, Valven

Wound Spreaders, self-retaining, blades

Separadores autoestáticos, valvas

Ecarteurs autostatiques, valves

Divaricatori autostatici, valve



1/2

Valven, gezahnt, Paar  
Blades, toothed, pair  
Valvas, dentado, par  
Valves, dentelé, paire  
Valve, dentate, paio

4 cm / 1 5/8" 15-774-40-07

4,5 cm / 1 6/8" 15-774-45-07

5 cm / 2" 15-774-50-07

5,5 cm / 2 1/8" 15-774-55-07

6 cm / 2 3/8" 15-774-60-07



15-774-00-07 & 15-774-25-07



1/2

Cloward

15-774-00-07

komplett mit je 2 Steckvalven  
Art.-Nr. 15-774-40-07 - 15-774-60-07

with 2 each plug-in blades  
ref. 15-774-40-07 - 15-774-60-07

con 2 valvas enchufables de c.u.  
ref. 15-774-40-07 - 15-774-60-07

chacun avec 2 valves interchangeables  
réf. 15-774-40-07 - 15-774-60-07

con 2 valve ad innesto  
rif. 15-774-40-07 - 15-774-60-07

15-774-25-07

25 cm / 9 7/8"

Sperrer allein  
Spreader only  
Separador solo  
Ecarteur seul  
Divaricatore solo



1/2

Valven, glatt, Paar  
Blades, smooth, pair  
Valvas, liso, par  
Valves, lisse, paire  
Valve, lisce, paio

4 cm / 1 5/8" 15-775-40-07

4,5 cm / 1 6/8" 15-775-45-07

5 cm / 2" 15-775-50-07

5,5 cm / 2 1/8" 15-775-55-07

6 cm / 2 3/8" 15-775-60-07



15-775-00-07 & 15-775-15-07



1/2

Cloward

15-775-00-07

komplett mit je 2 Steckvalven  
Art.-Nr. 15-775-40-07 - 15-775-60-07

with 2 each plug-in blades  
ref. 15-775-40-07 - 15-775-60-07

con 2 valvas enchufables de c.u.  
ref. 15-775-40-07 - 15-775-60-07

chacun avec 2 valves interchangeables  
réf. 15-775-40-07 - 15-775-60-07

con 2 valve ad innesto  
rif. 15-775-40-07 - 15-775-60-07

15-775-15-07

15 cm / 5 7/8"

Sperrer allein  
Spreader only  
Separador solo  
Ecarteur seul  
Divaricatore solo

## Wundspreizer, selbsthaltend

Wound Spreaders, self-retaining

Separadores autoestáticos

Ecarteurs autostatiques

Divaricatori autostatici

## Wundhaken, Halte- und Spreizsysteme

Retractors, Holding and spreading systems

Separadores, Sistemas de sujeción y dispersión

Ecarteurs, Systèmes de maintien et d'épandage

Divaricatori, Sistemi di tenuta e diffusione



1/2

Beckmann  
15-776-31-07

32 cm / 12 5/8"

stumpf  
blunt  
romo  
mousse  
smusso



4:4

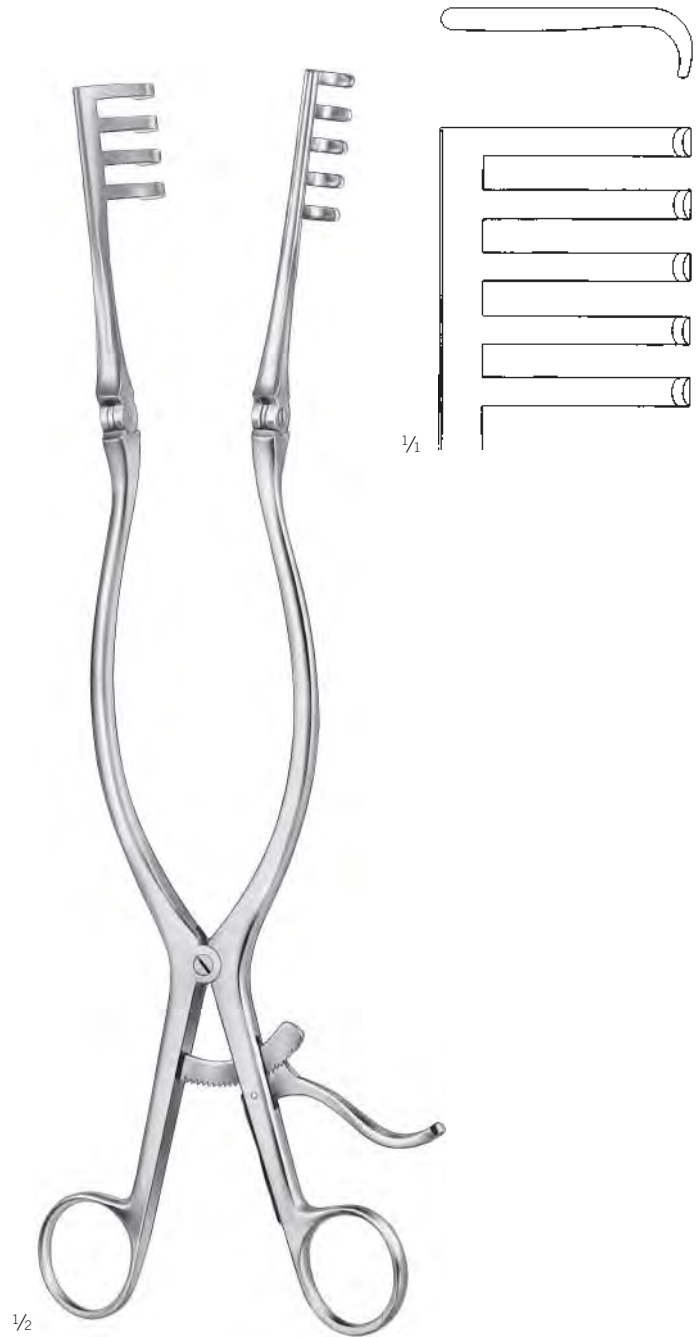

1/2

Adson  
15-777-32-07

33 cm / 13"

stumpf  
blunt  
romo  
mousse  
smusso



4:5

## Wundspreizer, selbsthaltend

Wound Spreaders, self-retaining

Separadores autoestáticos

Ecarteurs autostatiques

Divaricatori autostatici



142 mm



1/2

Beckman-Adson  
15-778-00-07 -  
15-778-03-07

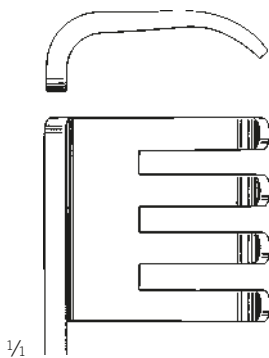

1/1

15-778-00-07

31 cm / 12 2/8"

stumpf  
blunt  
romo  
mousse  
smusso



4:4

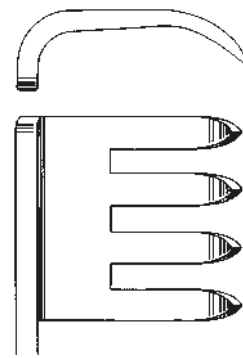

15-778-01-07

31 cm / 12 2/8"

scharf  
sharp  
agudo  
pointu  
acuto



4:4

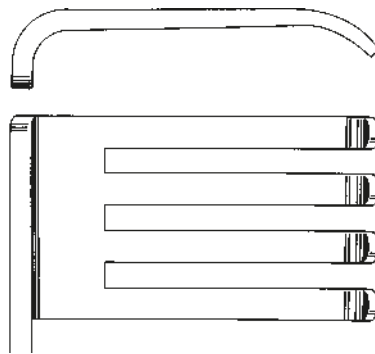

15-778-02-07

30,5 cm / 12 "

stumpf  
blunt  
romo  
mousse  
smusso



4:4

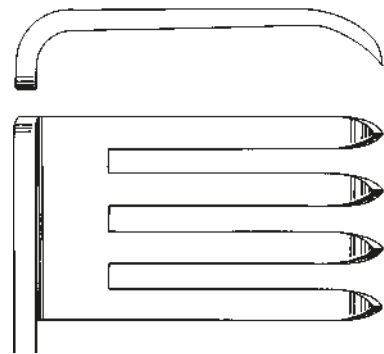

15-778-03-07

30,5 cm / 12 "

scharf  
sharp  
agudo  
pointu  
acuto



4:4



## Wundspreizer, selbthaltend

Wound Spreaders, self-retaining

Separadores autoestáticos

Ecarteurs autostatiques

Divaricatori autostatici

## Wundhaken, Halte- und Spreizsysteme

Retractors, Holding and spreading systems

Separadores, Sistemas de sujeción y dispersión

Ecarteurs, Systèmes de maintien et d'épandage

Divaricatori, Sistemi di tenuta e diffusione

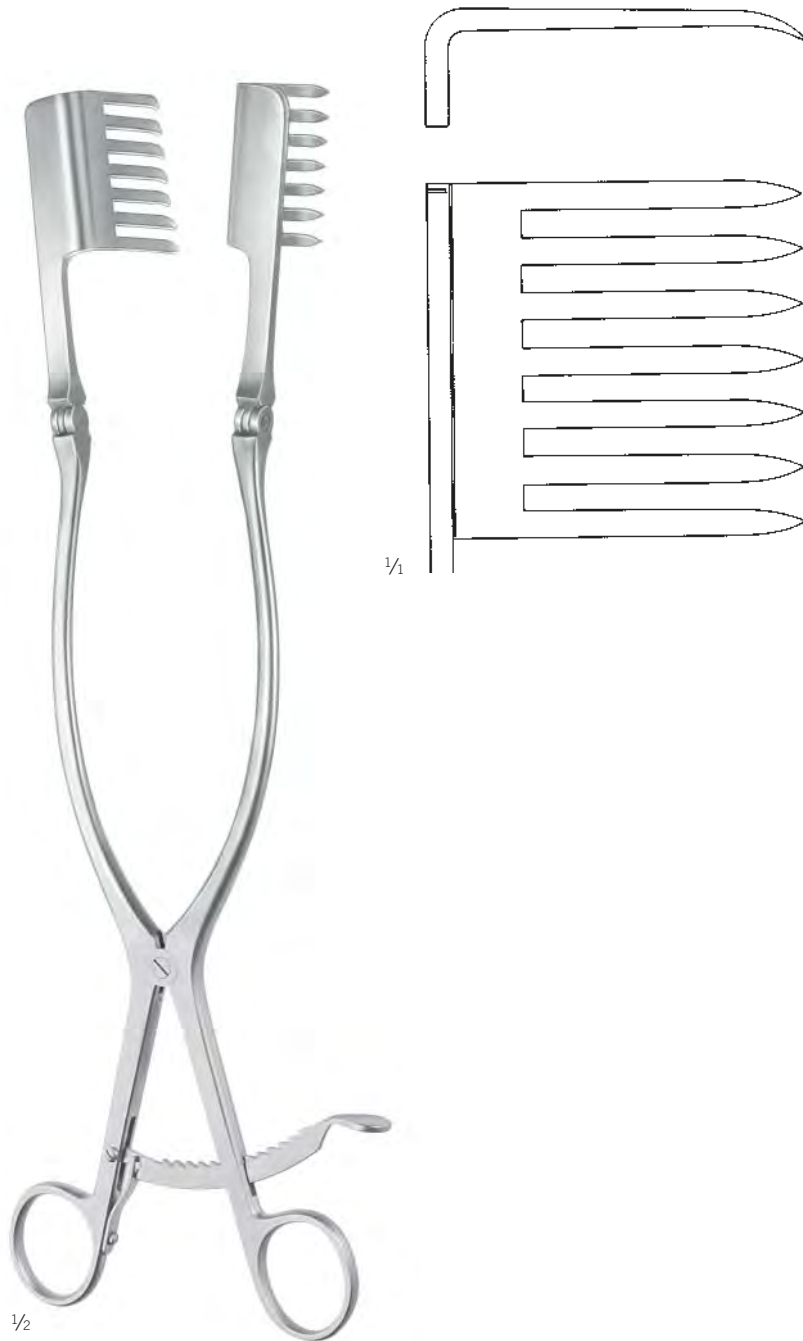

Beckman-Eaton  
15-778-32-07

32 cm / 12 5/8"

scharf

sharp

agudo

pointu

acuto



## Wundspreizer, selbsthaltend

Wound Spreaders, self-retaining

Separadores autoestáticos

Ecarteurs autostatiques

Divaricatori autostatici

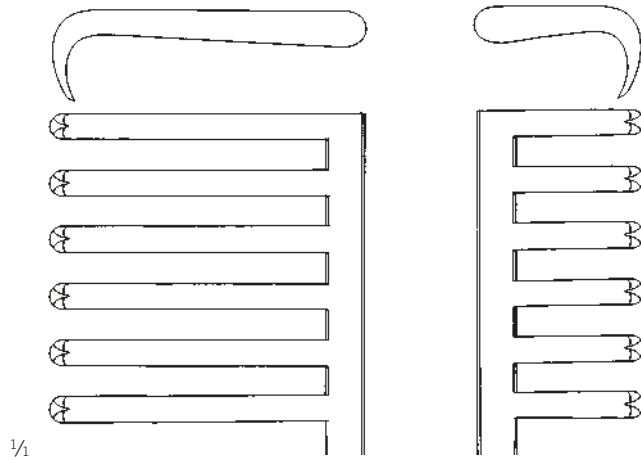

15-790-01-07

scharf, lange Zähne links  
sharp, long teeth on left side  
agudo, garfios largos a la izquierda  
pointu, griffes longues à gauche  
acuto, denti lunghi a sinistra



6:6



145 mm



1/2

Martin  
15-790-01-07 -  
15-790-02-07  
28,5 cm / 11 2/8"

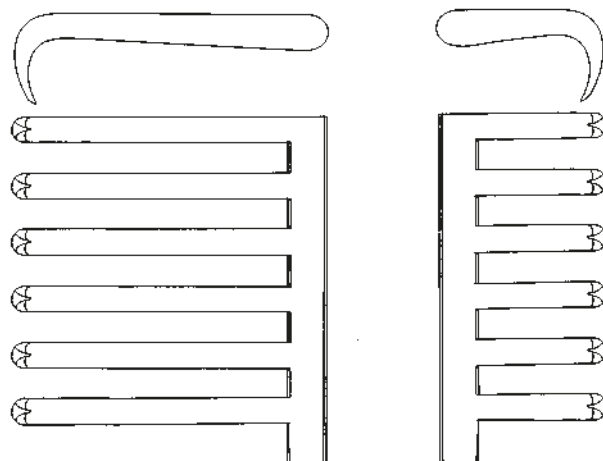

15-790-02-07

scharf, lange Zähne rechts  
sharp, long teeth on right side  
agudo, garfios largos a la derecha  
pointu, griffes longues à droite  
acuto, denti lunghi a destra



6:6



145 mm

## Wundspreizer, selbsthaltend

Wound Spreaders, self-retaining

Separadores autoestáticos

Ecarteurs autostatiques

Divaricatori autostatici

## Wundhaken, Halte- und Spreizsysteme

Retractors, Holding and spreading systems

Separadores, Sistemas de sujeción y dispersión

Ecarteurs, Systèmes de maintien et d'épandage

Divaricatori, Sistemi di tenuta e diffusione

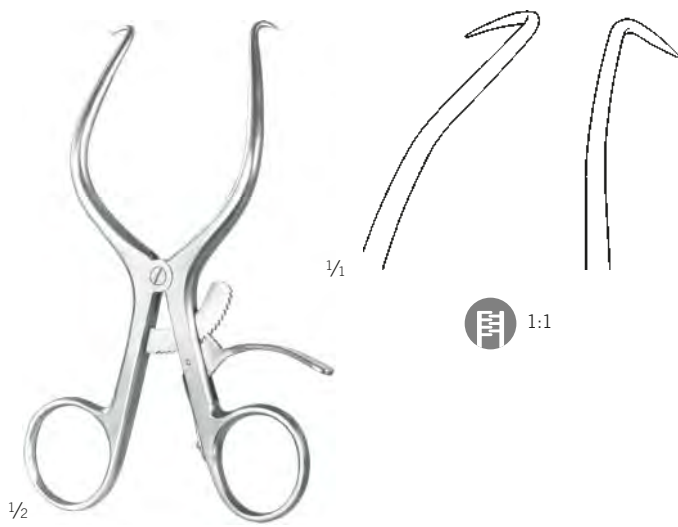

Gelpi  
15-802-13-07  
13 cm / 5 1/8"

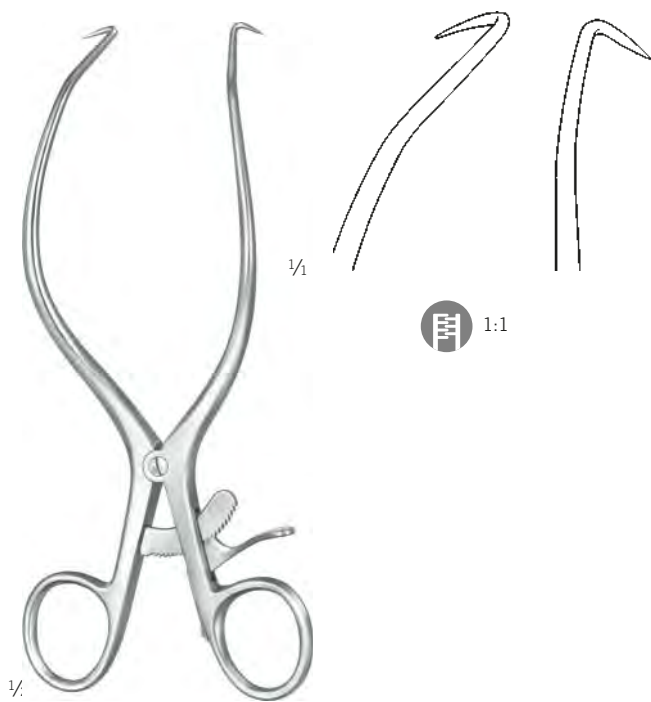

Gelpi  
15-802-18-07  
18 cm / 7 1/8"

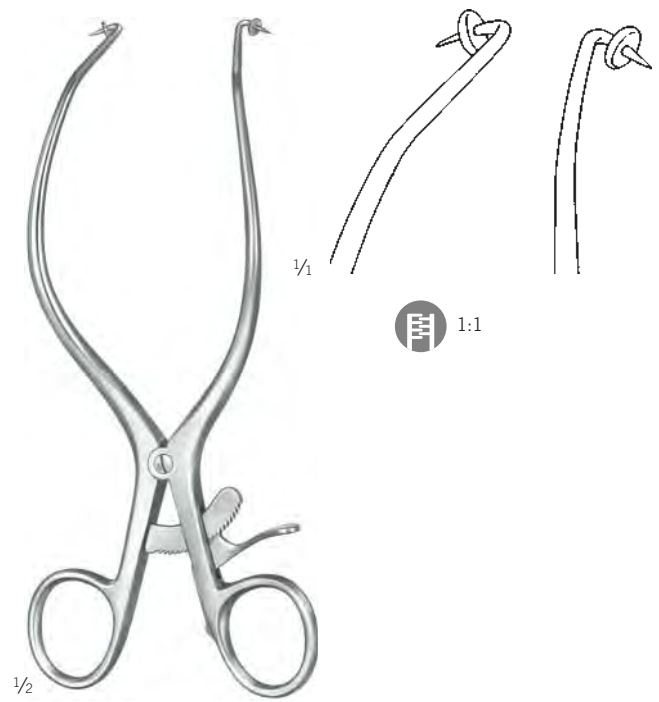

Gelpi  
15-804-18-07  
18,5 cm / 7 3/8"

## Zervikales Wirbelkörper-Distraktionssystem

Cervical Vertebral Body Distraction System

Sistema de distractor para los cuerpos vertebrales cervicales

Système de distracteur cervicale

Sistema di distrattore cervicale

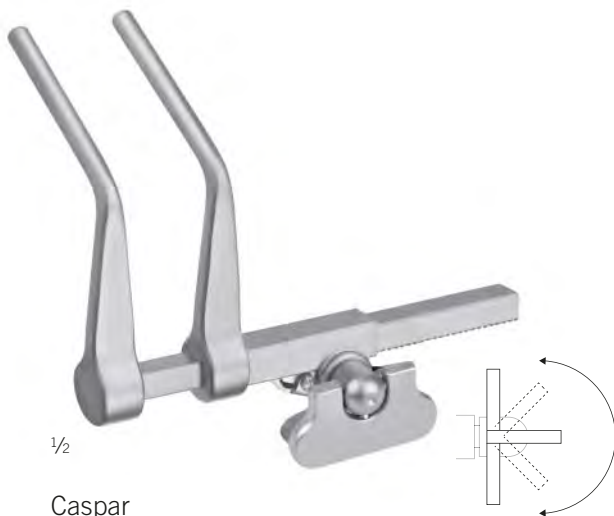

Caspar  
15-811-10-07 -15-811-11-07

rechtes Modell  
right model  
modelo derecho  
modèle droit  
modello destro

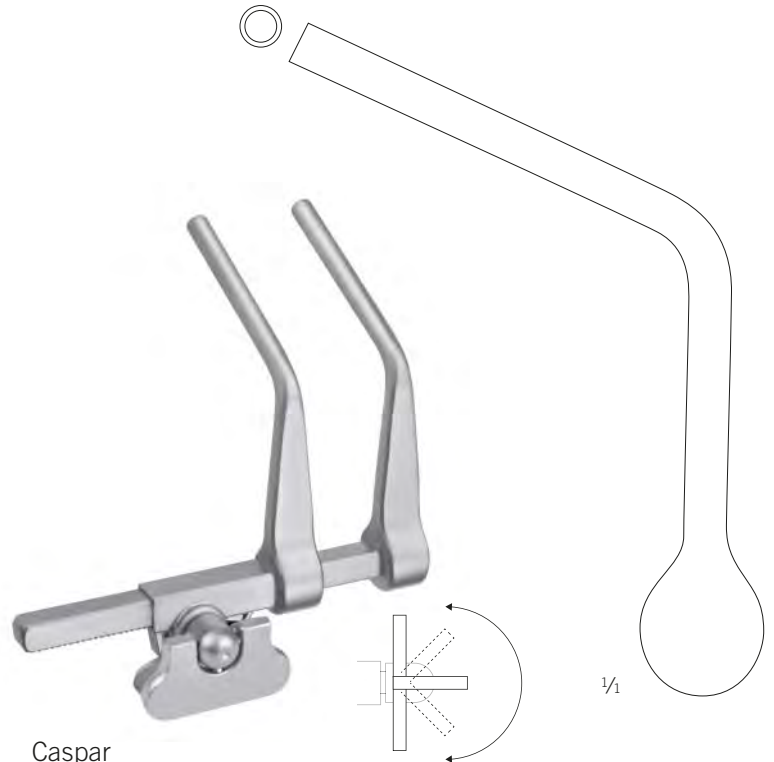

Caspar  
15-811-20-07 -15-811-21-07

linkes Modell  
left model  
modelo izquierdo  
modèle gauche  
modello sinistro

| <b>Zervikaler Distraktor</b><br><b>Cervical distractor</b><br><b>Distractor cervical</b><br><b>Distracteur cervicale</b><br><b>Distrattore cervicale</b> | kurze Zahnstange<br>short toothed rack<br>cremallera corta<br>crémaillère courte<br>cremagliera corta | lange Zahnstange<br>long toothed rack<br>cremallera larga<br>crémaillère longue<br>cremagliera lunga |
|--|---|--|
| rechtes Modell<br>right model<br>modelo derecho<br>modèle droit<br>modello destro  | 15-811-10-07  | 15-811-11-07   |
|  | 11 cm / 4 3/8"  | 13 cm / 5 1/8"   |
| linkes Modell<br>left model<br>modelo izquierdo<br>modèle gauche<br>modello sinistro   | 15-811-20-07  | 15-811-21-07   |
|  | 11 cm / 4 3/8"  | 13 cm / 5 1/8"   |

## Zervikales Wirbelkörper-Distraktionssystem

Cervical Vertebral Body Distraction System

Sistema de distractor para los cuerpos vertebrales cervicales

Système de distracteur cervicale

Sistema di distrattore cervicale

## Wundhaken, Halte- und Spreizsysteme

Retractors, Holding and spreading systems

Separadores, Sistemas de sujeción y dispersión

Ecarteurs, Systèmes de maintien et d'épandage

Divaricatori, Sistemi di tenuta e diffusione

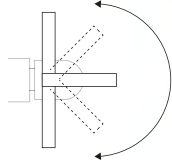

1/2

|  |   |
|--|---|
| <b>Bohrbuchse</b><br><b>Drillsocket</b><br><b>Guía de broca</b><br><b>Poignée guide-mèche</b><br><b>Boccola di guida</b> | für zervikalen Distraktor<br>for cervical distractor<br>para distractor cervical<br>pour distracteur cervicale<br>per distrattore cervicale |
| linkes Modell<br>left model<br>modelo izquierdo<br>modèle gauche<br>modello sinistro                                     | 15-811-30-07<br>20 cm / 7 7/8"  |
| rechtes Modell<br>right model<br>modelo derecho<br>modèle droit<br>modello destro  | 15-811-31-07<br>20 cm / 7 7/8"  |



1/1

1/2

Caspar  
15-811-30-07 - 15-811-31-07

Caspar  
15-811-40-07

23 cm / 9"

Schraubendreher für zervikale Distraction (Silikongriff)  
Screw driver for cervical distraction (silicone handle)  
Destornillador para distracción cervical (mango silicona)  
Tournevis pour distracteur cervical (manche silicone)  
Cacciavite per distrazione cervicale (manico silicone)



1/2

|       |              |
|-------|--------------|
| 12 mm | 15-811-50-07 |
| 14 mm | 15-811-51-07 |
| 16 mm | 15-811-52-07 |
| 18 mm | 15-811-53-07 |

Caspar  
15-811-50-07 - 15-811-53-07

Ø 8 mm

Schraube für zervikale Distraction  
Screw for cervical distraction  
Tornillo para distracción cervical  
Vis pour distraction cervicale  
Vite per distrazione cervicale



1/2

|       |              |
|-------|--------------|
| 14 mm | 15-811-60-07 |
| 8 mm  | 15-811-61-07 |

Caspar  
15-811-60-07 - 15-811-61-07

Ø 8 mm

Bohrer für zervikale Distraction  
Drill for cervical distraction  
Broca para distracción cervical  
Mèche pour distraction cervicale  
Punta per distrazione cervicale



## Instrumente für die lumbale Diskektomie

Instruments for lumbar Discectomy

Instrumentos para la disectomía lumbar

Instrumentes pour la disectomie lumbaire

Strumentario per discectomia lombare



Caspar

15-813-40-07 - 15-813-85-07

15 cm / 5 7/8"

Diskektomie-Spekulum

Discectomy-speculum

Espéculo de discectomía

Spéculum discectomie

Speculum per discectomia

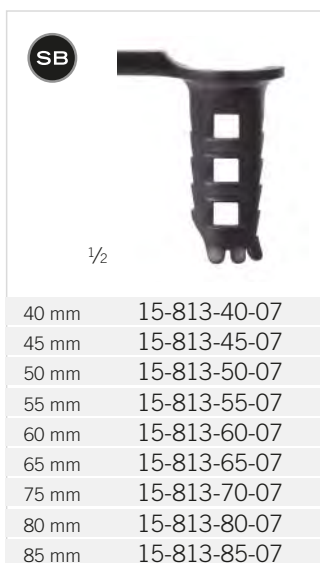

|       |              |
|-------|--------------|
| 40 mm | 15-813-40-07 |
| 45 mm | 15-813-45-07 |
| 50 mm | 15-813-50-07 |
| 55 mm | 15-813-55-07 |
| 60 mm | 15-813-60-07 |
| 65 mm | 15-813-65-07 |
| 75 mm | 15-813-70-07 |
| 80 mm | 15-813-80-07 |
| 85 mm | 15-813-85-07 |

## Instrumente für die lumbale Diskektomie

Instruments for lumbar Discectomy

Instrumentos para la disectomía lumbar

Instrumentes pour la disectomie lumbaire

Strumentario per discectomia lombare

## Wundhaken, Halte- und Spreizsysteme

Retractors, Holding and spreading systems

Separadores, Sistemas de sujeción y dispersión

Ecarteurs, Systèmes de maintien et d'épandage

Divaricatori, Sistemi di tenuta e diffusione



Caspar  
15-814-10-07

Diskektomie-Gegensperrer  
Counter retractor for discectomy  
Contrarretractor para discectomía  
Contre-rétracteur pour discectomie  
Contro-retrattore per discectomia

SB

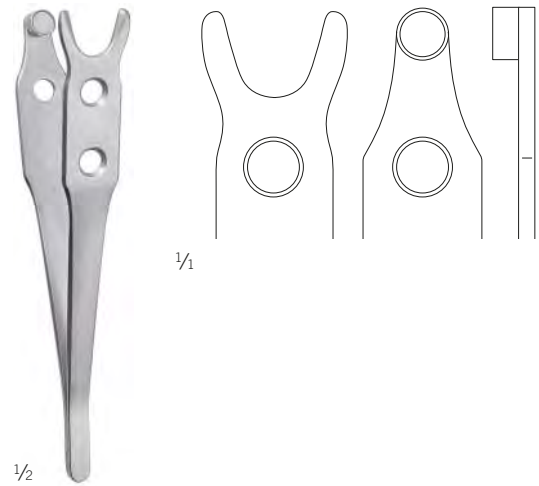

Caspar  
15-814-99-07

12 cm / 4 5/8"

Pinzette zum Austausch von Valven  
Forceps for the change of blades  
Pinzas para cambiar las valvas  
Pince pour changer les valves  
Pinze per sostituzione valve

➔ 15-814-10-07



SB

Valven, medial  
Blades, medial  
Valvas, mediales  
Valves, médiales  
Valve, mediali

|       |              |
|-------|--------------|
| 40 mm | 15-814-20-07 |
| 45 mm | 15-814-21-07 |
| 50 mm | 15-814-22-07 |
| 55 mm | 15-814-23-07 |
| 60 mm | 15-814-24-07 |
| 65 mm | 15-814-25-07 |
| 70 mm | 15-814-26-07 |
| 75 mm | 15-814-27-07 |

➔ 15-814-10-07



SB

Valven, lateral  
Blades, lateral  
Valvas, laterales  
Valves, latérales  
Valve, laterali

|       |              |
|-------|--------------|
| 35 mm | 15-814-40-07 |
| 40 mm | 15-814-41-07 |
| 45 mm | 15-814-42-07 |
| 50 mm | 15-814-43-07 |
| 55 mm | 15-814-44-07 |
| 60 mm | 15-814-45-07 |
| 65 mm | 15-814-46-07 |
| 75 mm | 15-814-47-07 |
| 80 mm | 15-814-48-07 |
| 85 mm | 15-814-49-07 |

➔ 15-814-10-07

## Wundspreizer für die zervikale Wirbelsäule

Retractors for cervical vertebral column

Separadores para la columna cervical

Ecarteurs pour colonne cervicale

Divaricatori per colonna cervicale

Arbeitsenden  
Working end  
El extremo funcional del producto  
Extrémité opératoire du produit  
L'estremità funzionale del prodotto

Ti

SB



Caspar  
15-901-01-07

11,5 cm / 4 1/8"

Retraktor, zervikal  
Cervical base retractor  
Retractor cervical básico  
Rétracteur cervical de base  
Retrattore cervicale di base

Ti SB

80 mm

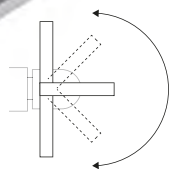

Caspar  
15-901-02-07

13 cm / 5 1/8"

Gegensperrer, längs  
Cervical base counter retractor  
Contrarretractor cervical básico  
Contre-rétracteur cervical de base  
Contro-retrattore cervicale di base

Ti SB

60 mm



Caspar  
15-901-03-07

20,5 cm / 8 1/8"

Gegensperrer, längs  
Cervical base counter retractor  
Contrarretractor cervical básico  
Contre-rétracteur cervical de base  
Contro-retrattore cervicale di base

Ti SB

50 mm



## Valven für die zervikale Wirbelsäule

Blades for cervical vertebral column

Valvas para la columna cervical

Valves pour colonne cervicale

Valve per colonna cervicale

## Wundhaken, Halte- und Spreizsysteme

Retractors, Holding and spreading systems

Separadores, Sistemas de sujeción y dispersión

Ecarteurs, Systèmes de maintien et d'épandage

Divaricatori, Sistemi di tenuta e diffusione



|            |   |
|------------|---|
|            |   |
| Ti         | Valven, medial-lateral<br>Blades, medial-lateral<br>Valvas, medial-lateral<br>Valves, médio-latérale<br>Valve, mediale-laterale |
| 19 x 25 mm | 15-901-11-09  |
| 19 x 30 mm | 15-901-12-09  |
| 19 x 35 mm | 15-901-13-09  |
| 19 x 40 mm | 15-901-14-09  |
| 19 x 45 mm | 15-901-15-09  |
| 19 x 50 mm | 15-901-16-09  |
| 19 x 55 mm | 15-901-17-09  |
| 19 x 60 mm | 15-901-18-09  |

|            |  |
|------------|--|
|            |  |
| Ti         | Valven, lateral<br>Blades, lateral<br>Valvas, lateral<br>Valves, latérale<br>Valve, laterale |
| 24 x 30 mm | 15-901-21-09   |
| 24 x 35 mm | 15-901-22-09   |
| 24 x 40 mm | 15-901-23-09   |
| 24 x 45 mm | 15-901-24-09   |
| 24 x 50 mm | 15-901-25-09   |
| 24 x 55 mm | 15-901-26-09   |
| 24 x 60 mm | 15-901-27-09   |
| 24 x 65 mm | 15-901-28-09   |
| 24 x 70 mm | 15-901-29-09   |

|            |  |
|------------|--|
|            |  |
| Ti         | Valven, medial<br>Blades, medial<br>Valvas, mediales<br>Valves, médiales<br>Valve, mediale |
| 24 x 30 mm | 15-901-31-09   |
| 24 x 35 mm | 15-901-32-09   |
| 24 x 40 mm | 15-901-33-09   |
| 24 x 45 mm | 15-901-34-09   |
| 24 x 50 mm | 15-901-35-09   |
| 24 x 55 mm | 15-901-36-09   |
| 24 x 60 mm | 15-901-37-09   |
| 24 x 65 mm | 15-901-38-09   |
| 24 x 70 mm | 15-901-39-09   |

➔ 15-901-01-07,  
15-901-02-07,  
15-901-03-07

➔ 15-901-01-07,  
15-901-02-07,  
15-901-03-07

➔ 15-901-01-07,  
15-901-02-07,  
15-901-03-07

|            |  |
|------------|--|
|            |  |
| Ti         | Valven, longitudinal, stumpf<br>Blades, longitudinal, blunt<br>Valvas, longitudinal, romo<br>Valves, longitudinal, emousse<br>Valve, longitudinales, mussa |
| 19 x 25 mm | 15-901-41-09   |
| 19 x 30 mm | 15-901-42-09   |
| 19 x 35 mm | 15-901-43-09   |
| 19 x 40 mm | 15-901-44-09   |
| 19 x 45 mm | 15-901-45-09   |
| 19 x 50 mm | 15-901-46-09   |
| 19 x 55 mm | 15-901-47-09   |
| 19 x 60 mm | 15-901-48-09   |

|            |  |
|------------|--|
|            |  |
| Ti         | Valven, longitudinal, stumpf<br>Blades, longitudinal, blunt<br>Valvas, longitudinal, romo<br>Valves, longitudinal, emousse<br>Valve, longitudinales, mussa |
| 24 x 35 mm | 15-901-51-09   |
| 24 x 40 mm | 15-901-52-09   |
| 24 x 45 mm | 15-901-53-09   |
| 24 x 50 mm | 15-901-54-09   |
| 24 x 55 mm | 15-901-55-09   |
| 24 x 60 mm | 15-901-56-09   |
| 24 x 65 mm | 15-901-57-09   |
| 24 x 70 mm | 15-901-58-09   |
| 24 x 75 mm | 15-901-59-09   |

➔ 15-901-01-07,  
15-901-02-07,  
15-901-03-07

➔ 15-901-01-07,  
15-901-02-07,  
15-901-03-07



## Wundspreizer für die lumbale Wirbelsäule

Retractors for for lumbal Column

Separadores para la columna lumbar

Instruments pour colonne lumbaire

Strumentario per colonna lombare



1/2

Caspar  
15-902-01-07

12,5 cm / 4 7/8"

Retraktor, lumbal

Lumbal base retractor

Retractor lumbar básico

Rétracteur lumbaire de base

Retrattore lombare di base



## Wundspreizer für die lumbale Wirbelsäule

Retractors for for lumbal Column  
 Separadores para la columna lumbar  
 Instruments pour colonne lumbaire  
 Strumentario per colonna lombare

## Wundhaken, Halte- und Spreizsysteme

Retractors, Holding and spreading systems  
 Separadores, Sistemas de sujeción y dispersión  
 Ecarteurs, Systèmes de maintien et d'épandage  
 Divaricatori, Sistemi di tenuta e diffusione

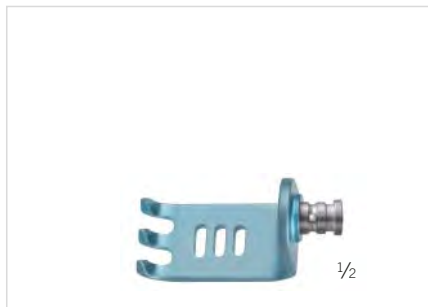

**Ti** Valven, lumbal  
 Blades, lumbal  
 Valvas, lumbar  
 Valves, lumbaire  
 Valve, lombare

|            |              |
|------------|--------------|
| 20 x 35 mm | 15-902-11-09 |
| 20 x 40 mm | 15-902-12-09 |
| 20 x 45 mm | 15-902-13-09 |
| 20 x 55 mm | 15-902-14-09 |
| 20 x 65 mm | 15-902-15-09 |



**Ti** Valven, lumbal  
 Blades, lumbal  
 Valvas, lumbar  
 Valves, lumbaire  
 Valve, lombare

|            |              |
|------------|--------------|
| 40 x 35 mm | 15-902-31-09 |
| 40 x 40 mm | 15-902-32-09 |
| 40 x 45 mm | 15-902-33-09 |
| 40 x 55 mm | 15-902-34-09 |
| 40 x 65 mm | 15-902-35-09 |
| 40 x 75 mm | 15-902-36-09 |



**Ti** Valven, lumbal  
 Blades, lumbal  
 Valvas, lumbar  
 Valves, lumbaire  
 Valve, lombare

|            |              |
|------------|--------------|
| 60 x 35 mm | 15-902-51-09 |
| 60 x 40 mm | 15-902-52-09 |
| 60 x 45 mm | 15-902-53-09 |
| 60 x 55 mm | 15-902-54-09 |
| 60 x 65 mm | 15-902-55-09 |
| 60 x 75 mm | 15-902-56-09 |
| 60 x 85 mm | 15-902-57-09 |

➔ 15-902-01-07

➔ 15-902-01-07

➔ 15-902-01-07



**Ti** Hemi-Laminektomie-Haken, klein  
 Hemi laminectomy hook, small  
 Hemi gancho para laminectomía, pequeño  
 Hemi crochet pour laminectomie, petit  
 Hemi uncino per laminectomia, piccolo

15-902-21-09



**Ti** Hemi-Laminektomie-Haken, groß  
 Hemi laminectomy hook, large  
 Hemi gancho para laminectomía, grande  
 Hemi crochet pour laminectomie, grand  
 Hemi uncino per laminectomia, grande

15-902-41-09

➔ 15-902-01-07

➔ 15-902-01-07

## Instrumente für die zervikale Wirbelsäule

Instruments for cervical vertebral column

Instrumentos para la columna cervical

Instruments pour colonne cervicale

Instrumentario per colonna cervicale

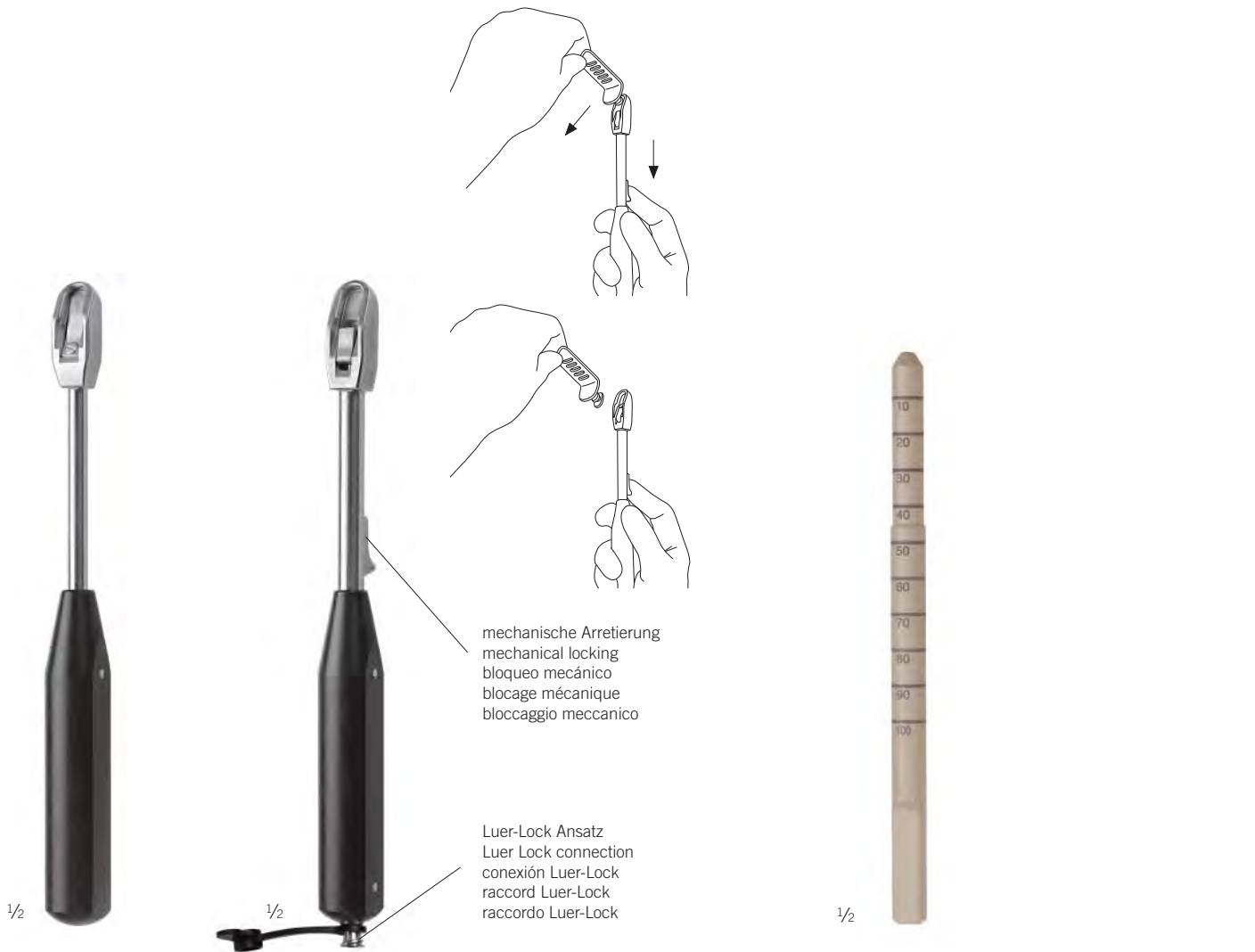

Caspar  
15-903-01-07

19 cm / 7 <sup>4</sup>/<sub>8</sub>"

Handgriff  
Handle  
Mango  
Poignée  
Impugnatura

Caspar  
15-903-02-07

19 cm / 7 <sup>4</sup>/<sub>8</sub>"

Handgriff mit Luer-Lock-Ansatz und Schutzkappe  
Handle with Luer Lock connection and protection cap  
Mango con conexión Luer-Lock y caperuza protectora  
Poignée avec raccord Luer-Lock et capuchon protecteur  
Impugnatura con raccordo Luer-Lock e calotta protettiva

Caspar  
15-903-03-04

17 cm / 6 <sup>6</sup>/<sub>8</sub>"

Messstab für zervikales Retraktorsystem  
Measurement handle for cervical retractor system  
Varilla de medición para el sistema de retracción cervical  
Jauge pour système de rétracteur cervical  
Asta di misurazione per sistema retrattore cervicale

## Laminektomiesperrer

Laminectomy Retractors  
Separadores para laminectomía  
Ecarteurs pour laminectomie  
Divaricatori per laminectomia

## Wundhaken, Halte- und Spreizsysteme

Retractors, Holding and spreading systems  
Separadores, Sistemas de sujeción y dispersión  
Ecarteurs, Systèmes de maintien et d'épandage  
Divaricatori, Sistemi di tenuta e diffusione



1/2

Scoville  
15-906-00-07  
22 cm / 8 5/8"



190 mm



1/2

Scoville-Haverfield  
15-906-50-07  
22 cm / 8 5/8"

Rahmen allein, mit Gelenk  
frame only, with joint  
bastidor suelto, con articulación  
cadre seul, avec articulation  
telaio solo, con articolazione



190 mm

## Valven

Blades  
Valvas  
Valves  
Valve



1/2

15-906-01-07  
5 cm / 2"

Hakenvalve, Stück  
Hook, piece  
Gancho, pieza  
Valve à griffes, pièce  
Uncino, pezzo

50 mm tief, stumpf  
50 mm deep, blunt  
50 mm de profundidad, romo  
profondeur 50 mm, mousse  
profondità 50 mm, smusso

➔ 15-906-00-07,  
15-906-50-07



15-906-02-07  
7 cm / 2 6/8"

Hakenvalve, Stück  
Hook, piece  
Gancho, pieza  
Valve à griffes, pièce  
Uncino, pezzo

70 mm tief, stumpf  
70 mm deep, blunt  
70 mm de profundidad, romo  
profondeur 70 mm, mousse  
profondità 70 mm, smusso

➔ 15-906-00-07,  
15-906-50-07



15-906-06-07  
5 cm / 2"

Hakenvalve, Stück  
Hook, piece  
Gancho, pieza  
Valve à griffes, pièce  
Uncino, pezzo

50 mm tief, spitz  
50 mm deep, sharp  
50 mm de profundidad, agudo  
profondeur 50 mm, pointu  
profondità 50 mm, acuto

➔ 15-906-00-07,  
15-906-50-07



15-906-07-07  
7 cm / 2 6/8"

Hakenvalve, Stück  
Hook, piece  
Gancho, pieza  
Valve à griffes, pièce  
Uncino, pezzo

70 mm tief, spitz  
70 mm deep, sharp  
70 mm de profundidad, agudo  
profondeur 70 mm, pointu  
profondità 70 mm, acuto

➔ 15-906-00-07,  
15-906-50-07



1/2

15-906-11-07 -  
15-906-13-07

Blattvalven, Stück  
Blades, piece  
Valvas, pieza  
Valves, pièce  
Valve, pezzo

gezahnt  
toothed  
dentado  
dentelé  
dentato

|              |            |
|--------------|------------|
| 15-906-11-07 | 60 x 25 mm |
| 15-906-12-07 | 61 x 50 mm |
| 15-906-13-07 | 86 x 25 mm |

➔ 15-906-00-07,  
15-906-50-07



15-906-41-07 -  
15-906-44-07

Hakenvalve, Stück  
Hook, piece  
Valva, pieza  
Valve, pièce  
Valvola, pezzo

spitz  
sharp  
agudo  
pointu  
acuto

|              |            |
|--------------|------------|
| 15-906-41-07 | 48 x 50 mm |
| 15-906-42-07 | 64 x 50 mm |
| 15-906-43-07 | 64 x 64 mm |
| 15-906-44-07 | 80 x 57 mm |

➔ 15-906-00-07,  
15-906-50-07



15-906-46-07 -  
15-906-47-07

Hakenvalve, Stück  
Hook, piece  
Valva, pieza  
Valve, pièce  
Valvola, pezzo

spitz  
sharp  
agudo  
pointu  
acuto

|              |            |
|--------------|------------|
| 15-906-46-07 | 44 x 38 mm |
| 15-906-47-07 | 67 x 44 mm |

➔ 15-906-00-07,  
15-906-50-07

## Wirbelkörperspreizer

Lamina Spreaders

Separadores para cuerpos vertebrales

Ecarteurs pour corps vertébraux

Separatori per vertebre

## Wundhaken, Halte- und Spreizsysteme

Retractors, Holding and spreading systems

Separadores, Sistemas de sujeción y dispersión

Ecarteurs, Systèmes de maintien et d'épandage

Divaricatori, Sistemi di tenuta e diffusione



15-812-01-07

12,7 cm / 4 9/8"



15-812-21-07

|   |  |
|---|--|
| <b>Wirbelkörperspreizer</b><br><b>Lamina Spreaders</b><br><b>Separadores para cuerpos vertebrales</b><br><b>Ecarteurs pour corps vertébraux</b><br><b>Separatori per vertebre</b> | lange Zahnstange<br>long toothed rack<br>cremallera larga<br>crémaillère longue<br>cremagliera lunga |
| 3 Zähne<br>3 teeth<br>3 dientes<br>3 dents<br>3 denti   |  |
|   | 15-812-21-07<br>13 cm / 5 1/8"   |

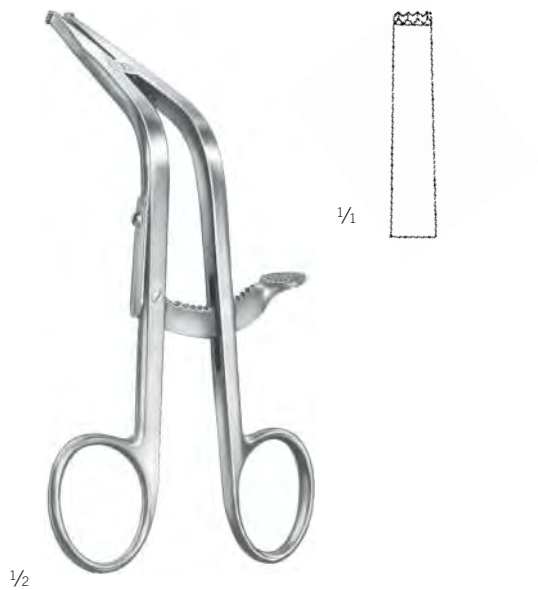

Cloward  
24-973-16-07

16 cm / 6 3/8"

## Wirbelkörperspreizer

Lamina Spreaders

Separadores para cuerpos vertebrales

Ecarteurs pour corps vertébraux

Separatori per vertebre

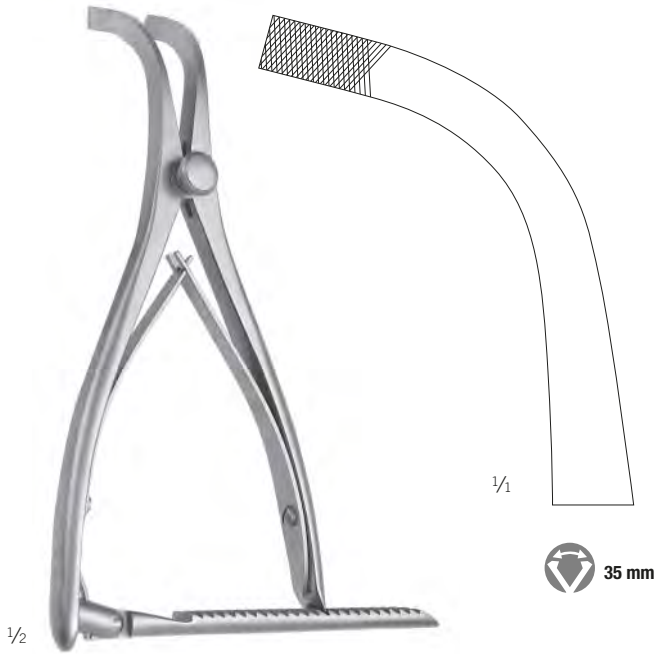

Inge  
24-974-17-07  
16 cm / 6 2/8"

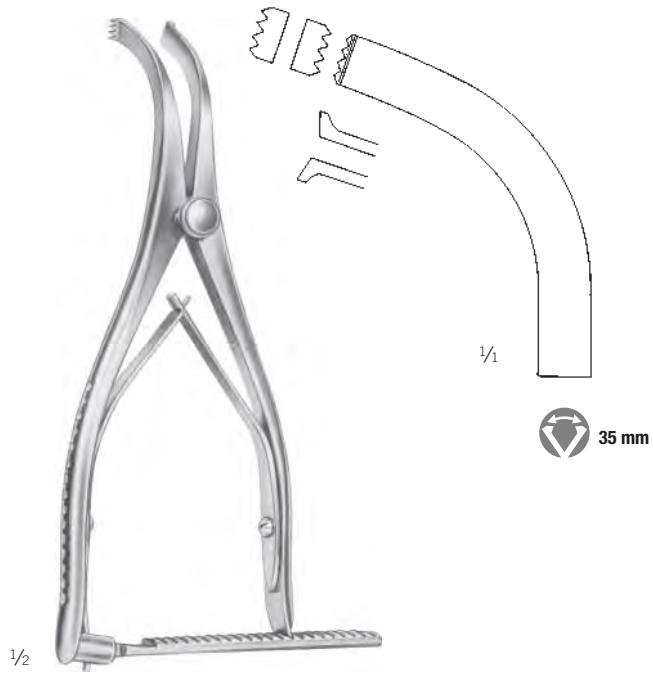
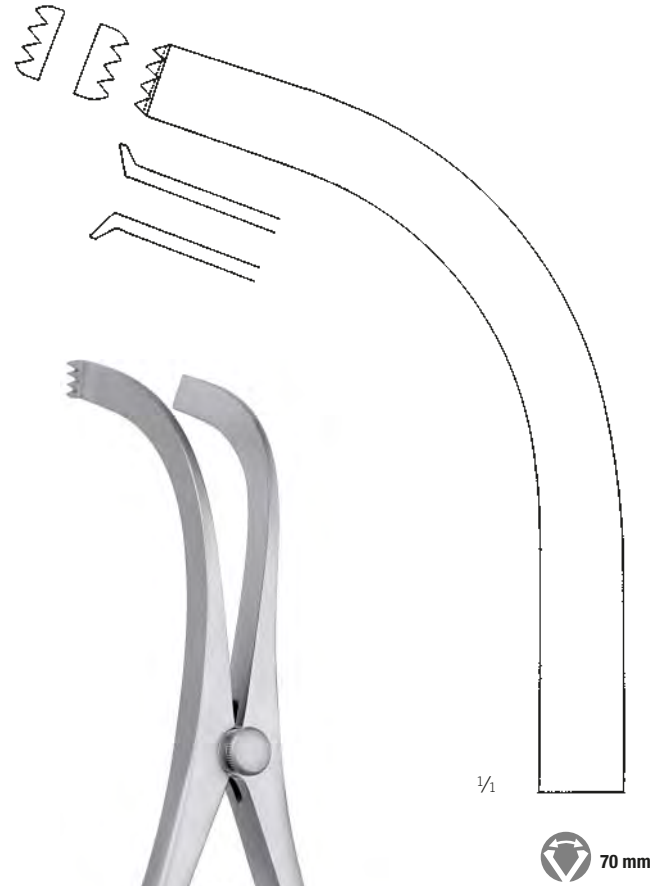

Inge  
24-975-17-07  
16 cm / 6 2/8"

Inge  
24-977-27-07  
25,5 cm / 10 "



## Schädelhalter

Skull Traction Tongs

Estribos de tracción craneal

Pinces de traction crânienne

Pinze per trazione craniale

## Wundhaken, Halte- und Spreizsysteme

Retractors, Holding and spreading systems

Separadores, Sistemas de sujeción y dispersión

Ecarteurs, Systèmes de maintien et d'épandage

Divaricatori, Sistemi di tenuta e diffusione



1/2

Crutchfield  
24-641-01-07

kleines Modell  
small pattern  
modelo pequeño  
modèle petit  
modello piccolo



1/2

Crutchfield  
24-641-02-07

mittleres Modell  
medium pattern  
modelo mediano  
modèle moyen  
modello medio



1/2

24-641-04-07

7 cm / 2 5/8"

Vorbohrer  
Drill point  
Perforador  
Alésoir  
Alesatore  
3,5 mm Ø



24-641-05-07

7 cm / 2 5/8"

Vorbohrer  
Drill point  
Perforador  
Alésoir  
Alesatore  
5 mm Ø



24-641-02-07



24-641-02-07



1/2

24-643-01-07

großes Modell  
large pattern  
modelo grande  
modèle grand  
modello grande

24-643-10-07

Ersatzdorn  
Spare pin  
Espina de repuesto  
Pointe de rechange  
Punta di ricambio



24-643-01-07

## Retraktoren zur Fixation am Schädel

Self-Retaining Retractors, for Skull Mounting

Separadores para la fijación del cráneo

Ecarteurs autofixants au crâne

Autofissatore per retrattori, per il supporto del cranio



| Leyla<br>24-702-01-07 | Selbsthaltender Hirnspatel mit 1 Spannarm, komplett, bestehend aus: | Self-retaining brain retractor with 1 flexible arm, complete, consisting of: | Separador automático para el cerebro con 1 brazo, completo, compuesto de: | Ecarteur autofixant au crâne avec 1 bras complet, composé de: | Autofissatore per retrattore cervicale con 1 braccio, completo, composto da: |
|-----------------------|---|--|---|---|--|
| 24-702-03-07          | 1 Spannarm, flexibel  | Flexible arm   | Brazo, flexible   | Bras flexible   | Braccio flessibile   |
| 24-702-04-07          | 1 Fixiervorrichtung für 1 Spannarm                                  | Fixation base for 1 arm  | Fijador para 1 brazo  | Base de fixation pour 1 bras                                  | Base di fissaggio per 1 braccio  |
| 24-702-08-07          | 1 Spatelhalter für flache Spatel                                    | Support for flat brain spatulas  | Porta-espátulas para espátulas planas                                     | Support pour spatules plats                                   | Supporto per spatole cervicali piatte  |



| Leyla<br>24-702-02-07 | Selbsthaltender Hirnspatel mit 2 Spannarmen, komplett, bestehend aus: | Self-retaining brain retractor with 2 arms, complete, consisting of: | Separador automático para el cerebro con 2 brazos, completo, compuesto de: | Ecarteur autofixant au crâne avec 2 bras complet, composé de: | Autofissatore per retrattore cervicale con 2 bracci, completo, composto da: |
|-----------------------|---|--|--|---|---|
| 24-702-03-07          | 2 Spannarme, flexibel   | Flexible arms  | Brazos, flexibles  | Bras, flexibles   | Bracci, flessibili  |
| 24-702-05-07          | 1 Fixiervorrichtung für 2 Spannarme                                   | Fixation base for 2 arms   | Fijador para 2 brazos  | Base de fixation pour 2 bras                                  | Base di fissaggio per 2 bracci  |
| 24-702-08-07          | 2 Spatelhalter für flache Spatel                                      | Supports for flat brain spatulas                                     | Porta-espátulas para espátulas planas                                      | Supports pour spatules plats                                  | Supporti per spatole cervicali piatte                                       |

## Zubehör zu Leyla-Retraktoren

Accessories for Leyla Self Retaining Retractors  
Accesorios para separadores automáticos de Leyla  
Accessoires pour écarteurs autofixants de Leyla  
Accessori per autofissatori per retrattori di Leyla

## Wundhaken, Halte- und Spreizsysteme

Retractors, Holding and spreading systems  
Separadores, Sistemas de sujeción y dispersión  
Ecarteurs, Systèmes de maintien et d'épandage  
Divaricatori, Sistemi di tenuta e diffusione



Leyla  
24-702-03-07

Spannarm zum Aufstecken auf Kupplungsköpfe 24-702-15-07 / 24-702-16-07 und Fixiervorrichtungen 24-702-04-07 / 24-702-05-07 / 24-702-06-07

Flexible arm for attaching coupling heads 24-702-15-07 / 24-702-16-07 and fixation bases 24-702-04-07 / 24-702-05-07 / 24-702-06-07

Brazo para colocar sobre el acoplamiento 24-702-15-07 / 24-702-16-07 y los fijadores 24-702-04-07 / 24-702-05-07 / 24-702-06-07

Bras flexible pour fixation aux têtes d'accouplement 24-702-15-07 / 24-702-16-07 et base de fixation 24-702-04-07 / 24-702-05-07 / 24-702-06-07

Braccio flessibile per il fissaggio delle teste di accoppiamento 24-702-15-07 / 24-702-16-07 e le basi di fissaggio 24-702-04-07 / 24-702-05-07 / 24-702-06-07



Leyla  
24-702-04-07

Fixiervorrichtung für 1 Spannarm 24-702-03-07, zum Festschrauben am Schädel

Fixation base for 1 flexible arm 24-702-03-07, for skull mounting

Fijador para 1 brazo 24-702-03-07, para atornillar al cráneo

Base de fixation pour 1 bras 24-702-03-07, pour fixer au crâne

Base di fissaggio per 1 braccio flessibile 24-702-03-07, per il supporto del cranio



Leyla  
24-702-05-07

Fixiervorrichtung für 2 Spannarme 24-702-03-07, zum Festschrauben am Schädel

Fixation base for 2 flexible arms 24-702-03-07, for skull mounting

Fijador para 2 brazos 24-702-03-07, para atornillar al cráneo

Base de fixation pour 2 bras 24-702-03-07, pour fixer au crâne

Base di fissaggio per 2 bracci flessibili 24-702-03-07, per il supporto del cranio



Leyla  
24-702-06-07

Fixiervorrichtung für 1 Spannarm 24-702-03-07, zum Festschrauben an Rohrteilen bis Ø 16 mm

Fixation base for 1 flexible arm 24-702-03-07, for mounting to bars up to Ø 16 mm

Fijador para 1 brazo 24-702-03-07, para atornillar a tubos hasta Ø 16 mm

Base de fixation pour 1 bras 24-702-03-07, pour fixer aux tubes jusqu'à Ø 16 mm

Base di fissaggio per 1 braccio flessibile 24-702-03-07, per il supporto di asta di raccordo da Ø 16 mm



Leyla  
24-702-07-07

Spatelhalter mit Rundschaft bis Ø 5,5 mm, zur Befestigung am Spannarm 24-702-03-07

Support for brain spatulas with round shaft up to Ø 5.5 mm, fixation to flexible arm 24-702-03-07

Porta-espátula con vástago redondo hasta Ø 5,5 mm, para sujetarlo al brazo 24-702-03-07

Support pour spatules avec tiges ronds jusqu'à Ø 5,5 mm, pour fixation au bras 24-702-03-07

Supporto per spatole craniali con diametro asse Ø 5,5 mm, fissato al braccio flessibile 24-702-03-07



Leyla  
24-702-08-07

Spatelhalter für flache Spatel, zur Befestigung am Spannarm 24-702-03-07

Support for flat brain spatulas, fixation to flexible arm 24-702-03-07

Porta-espátula para espátulas planas, para sujetarlo al brazo 24-702-03-07

Support pour tiges plats, pour fixation au bras 24-702-03-07

Supporto per spatole cervicali piate, fissato al braccio flessibile 24-702-03-07

## Retraktoren zur Fixation am OP-Tisch

Self-Retaining Retractors, Fixation to Operating Table

Separadores para la fijación a la mesa de operaciones

Ecarteurs pour fixation à la table d'opération

Autofissatore per retrattori, da fissare alla tavola operatoria



| Leyla<br>24-702-11-07 | Selbsthaltender Hirnspatel mit 1 Spannarm, komplett, bestehend aus: | Self-retaining brain retractor with 1 flexible arm, complete, consisting of: | Separador automático para el cerebro con 1 brazo, completo, compuesto de: | Ecarteur du cerveau auto-fixant avec 1 bras complet, composé de: | Autofissatore per retrattori cervicali con 1 braccio flessibile, composto da: |
|-----------------------|---|--|---|--|---|
| 24-702-03-07          | 1 Spannarm  | Flexible arm   | Brazo   | Bras flexible  | Braccio flessibile  |
| 24-702-07-07          | 1 Spatelhalterung für Spatel mit rundem Griff                       | Support, for brain spatulas with round shaft                                 | Porta-espátula para espátulas con mangos redondos                         | Support pour spatules avec manches ronds                         | Supporto per spatole craniali con albero rotondo                              |
| 24-702-13-07          | 1 Kugelgelenkkloben   | Ball and socket joint  | Articulación esférica   | Articulation sphérique   | Giunto a sfera ad incastro  |
| 24-702-14-07          | 1 Haltearm  | Holding rod  | Brazo de apoyo  | Bras de fixation   | Porta-asta  |
| 24-702-15-07          | 1 Kupplungskopf   | Coupling head  | Acoplamiento  | Tête d'accouplement  | Testa accoppiamento   |



| Leyla<br>24-702-12-07 | Selbsthaltender Hirnspatel mit 2 Spannarmen, komplett, bestehend aus: | Self-retaining brain retractor with 2 flexible arms, complete, consisting of: | Separador automático para el cerebro con 2 brazos, completo, compuesto de: | Ecarteur du cerveau auto-fixant avec 2 bras complet, composé de: | Autofissatore per retrattori cervicali con 2 bracci flessibili, composto da: |
|-----------------------|---|---|--|--|--|
| 24-702-03-07          | 2 Spannarme   | Flexible arms   | Brazos   | Bras flexibles   | Bracci flessibili  |
| 24-702-07-07          | 1 Spatelhalterung, für flache Spatel                                  | Support, for flat brain spatulas  | Porta-espátula, para espátulas planas                                      | Support pour spatules plats                                      | Supporto per spatole craniali piatte   |
| 24-702-08-07          | 1 Spatelhalterung, für Spatel mit rundem Griff                        | Support, for brain spatulas with round shaft                                  | Porta-espátula para espátulas con mangos redondos                          | Support pour spatules avec manches ronds                         | Supporto per spatole craniali con albero rotondo                             |
| 24-702-13-07          | 1 Kugelgelenkkloben   | Ball and socket joint   | Articulación esférica  | Articulation sphérique   | Giunto a sfera ad incastro   |
| 24-702-14-07          | 1 Haltearm  | Holding rod   | Brazo de apoyo   | Bras de fixation   | Porta-asta   |
| 24-702-16-07          | 2 Kupplungsköpfe  | Coupling heads  | Acoplamientos  | Têtes d'accouplement   | Teste accoppiamento  |

## Zubehör zu Leyla-Retraktoren

Accessories for Leyla Retractors

Accesorios para separadores automáticos Leyla

Accessoires pour écarteurs de Leyla

Accessori per autofissatori per retrattori di Leyla

## Wundhaken, Halte- und Spreizsysteme

Retractors, Holding and spreading systems

Separadores, Sistemas de sujeción y dispersión

Ecarteurs, Systèmes de maintien et d'épandage

Divaricatori, Sistemi di tenuta e diffusione



Leyla  
24-702-13-07

Kugelgelenkkloben, zur Befestigung des Haltearms 24-702-14-07 an OP-Tisch-Schienen

Ball and socket joint, for fixation of holding rod 24-702-14-07 to pole of operating table

Articulación esférica, para sujetar el brazo de apoyo 24-702-14-07 sobre la mesa de operaciones

Articulation sphérique pour fixation du bras 24-702-14-07 aux bandes de la table d'opération

Giunto a sfera ad incastro, per il fissaggio dell'asta 24-702-14-07 all'estremità del tavolo operatorio



Leyla  
24-702-14-07

Haltearm zur Fixation im Kugelgelenkkloben 24-702-13-07 und zur Aufnahme der Kupplungsköpfe 24-702-15-07 / 24-702-16-07

Holding rod for fixation in ball and socket joint 24-702-13-07 and to take coupling heads 24-702-15-07 / 24-702-16-07

Brazo de apoyo para fijar en la articulación esférica 24-702-13-07 y para recoger los acoplamientos 24-702-15-07 / 24-702-16-07

Bras d'appui pour fixer dans l'articulation sphérique 24-702-13-07 pour prendre les têtes d'accouplement 24-702-15-07 / 24-702-16-07

Porta asta per il fissaggio al giunto a sfera 24-702-13-07 e per prendere le teste di accoppiamento 24-702-15-07 / 24-702-16-07



Leyla  
24-702-15-07

Kupplungskopf zur Aufnahme von 1-5 Spannarmen 24-702-03-07

Coupling head to take 1-5 flexible arms 24-702-03-07

Acoplamiento para sujetar 1-5 brazos 24-702-03-07

Tête d'accouplement pour prendre 1-5 bras flexibles 24-702-03-07

Testa accoppiamento per prendere 1-5 bracci flessibili 24-702-03-07



Leyla  
24-702-16-07

Kupplungskopf, drehbar, in allen Ebenen fixierbar,

zur Aufnahme von 1 Spannarm 24-702-03-07

Coupling head, turnable, can be fixed in any position, to take 1 flexible arm 24-702-03-07

Acoplamiento, girable y se puede fijar en todas las posturas para sujetar un brazo 24-702-03-07

Tête d'accouplement, rotative, peut être fixée en toute position, pour tenir 1 bras flexible 24-702-03-07

Testa accoppiamento, girevole, può essere fissata in qualsiasi posizione, supporta 1 braccio flessibile 24-702-03-07

# Spatel

Spatulas  
Espátulas  
Spatules  
Spatole



15-975-13-01

20 cm / 7 7/8"

13 mm

15-975-16-01

20 cm / 7 7/8"

16 mm

1/2

## Martin

15-975-13-01 -  
15-975-16-01

biegsam, sehr weich  
malleable, very soft  
maleable, muy blando  
malléable, très souple  
malleabile, molto dolce



1/1

24-535-18-07

18,5 cm / 7 2/8"

24-535-21-07

21,5 cm / 8 4/8"

1/2

24-535-18-07 -  
24-535-21-07

Intimaspatel  
Intima Spatulas  
Espátulas para la íntima  
Spatules pour la tunique interne  
Spatole per intima

➔ 24-702-08-07



1/2

|              |             |
|--------------|-------------|
| 24-720-08-01 | 155 x 8 mm  |
| 24-720-11-01 | 155 x 11 mm |
| 24-720-14-01 | 155 x 14 mm |
| 24-720-17-01 | 155 x 17 mm |

## Heifetz

24-720-08-01 -  
24-720-17-01

biegsam  
malleable  
maleable  
malléable  
malleabile

➔ 24-702-07-07



1/1

|              |             |
|--------------|-------------|
| 24-721-14-01 | 200 x 14 mm |
| 24-721-17-01 | 200 x 17 mm |
| 24-721-20-01 | 200 x 20 mm |

## Heifetz

24-721-14-01 -  
24-721-20-01

biegsam  
malleable  
maleable  
malléable  
malleabile

➔ 24-702-07-07

Diagnostik  
Diagnostics  
Diagnóstico  
Diagnostic  
Diagnostica

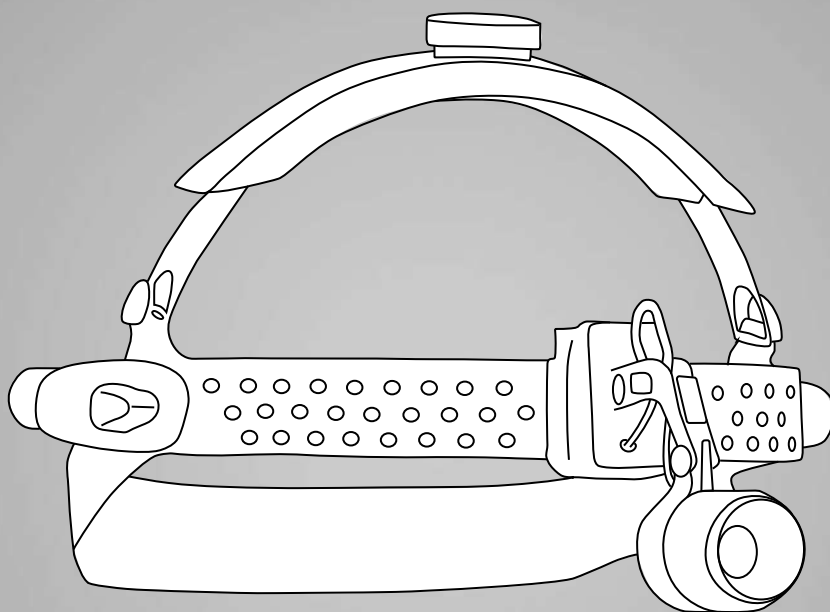

## Spezial-Produkte

Special Products

Produits spéciaux

Prodotti speciali

Productos especiales

Informationen zu den KLS-Martin-Stirnleuchten entnehmen Sie bitte der separaten Broschüre „MedLED® Spectra“.

Please refer to the separate brochure for information about KLS-Martin headlights “MedLED® Spectra”.

Encontrará información sobre las lámparas frontal de KLS-Martin en el folletos individual “MedLED® Spectra”.

Veuillez vous reporter au brochure séparée pour obtenir des informations détaillées relatives aux lampes frontales «MedLED® Spectra» .

Per informazioni sulle lampada frontale di KLS Martin, consultare le brochure separate KLS Martin “MedLED® Spectra”.



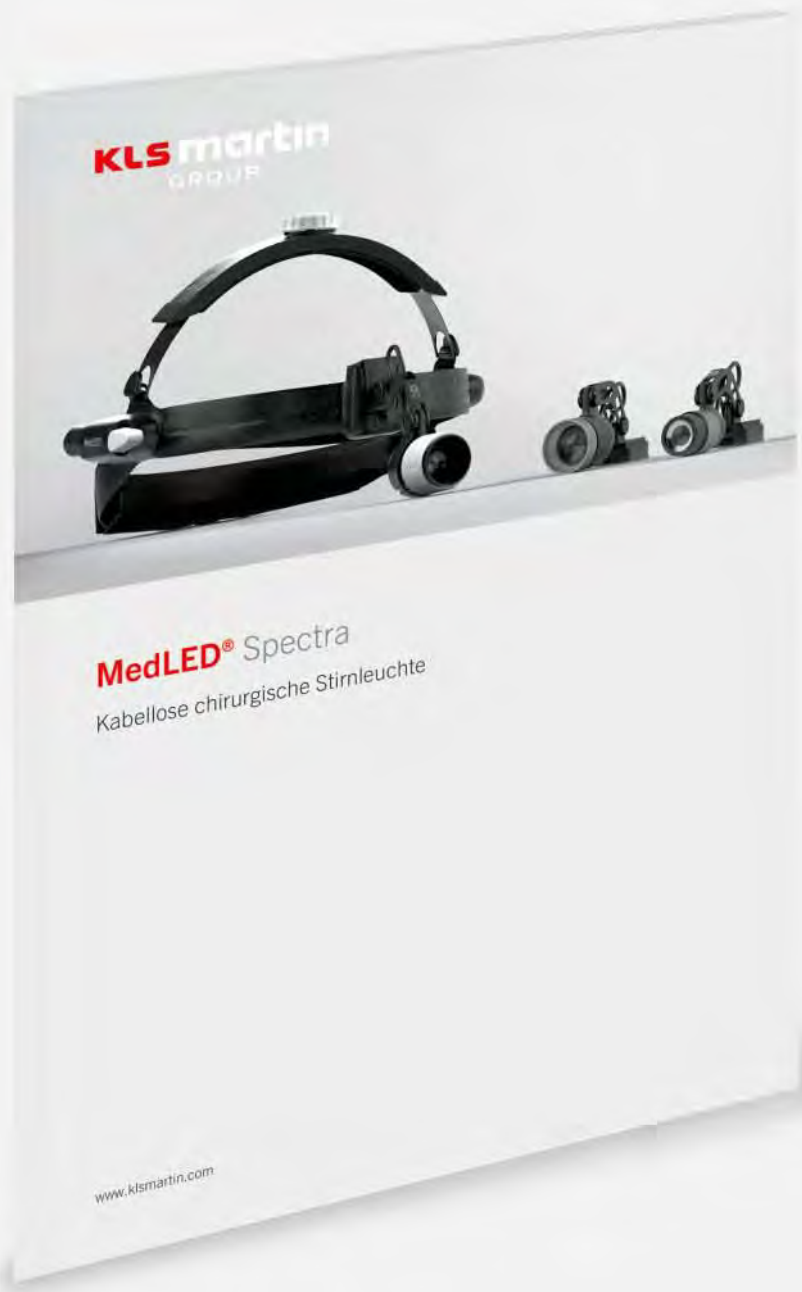
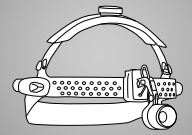



Sauger, Kanülen  
Suction Tubes, Cannulas  
Tubos de Aspiración, Cánulas  
Tubes d'aspiration, Canules  
Tubi d'aspirazione, Cannule

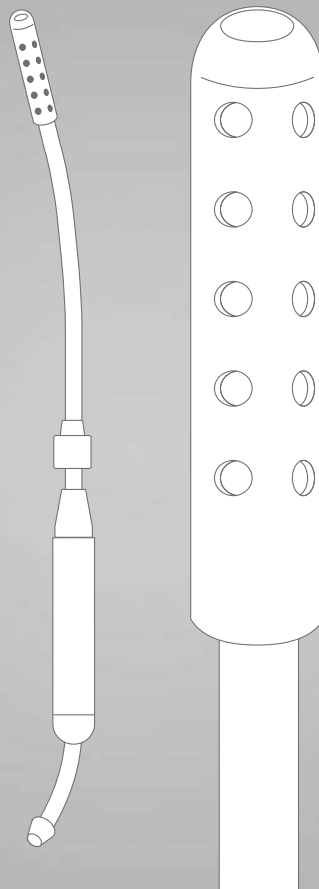

## Sauger, Saugrohre

Suction cannulas, Suction Tubes

Cánulas de aspiración, Tubos de aspiración

Canules d'aspiration, Tubes d'aspiration

Cannule di aspirazione, Tubi di aspirazione



1/2

|              | Arbeitslänge<br>working length<br>largo útil<br>longueur utile<br>lunghezza utile |          |
|--------------|---|----------|
| 18-521-31-01 | 200 mm  | Ø 3,0 mm |
| 18-521-21-01 | 200 mm  | Ø 4,0 mm |
| 18-521-51-01 | 200 mm  | Ø 5,0 mm |



1/2

**Ø 3,3 mm**  
Frazier  
18-522-10-01  
24 cm / 9 4/8"



1/2

Frazier  
18-523-06-01 -  
18-523-13-01  
19,5 cm / 7 5/8"

|              | Arbeitslänge<br>working length<br>largo útil<br>longueur utile<br>lunghezza utile |          |
|--------------|---|----------|
| 18-523-06-01 | 130 mm  | Ø 2,0 mm |
| 18-523-07-01 | 130 mm  | Ø 2,3 mm |
| 18-523-08-01 | 130 mm  | Ø 2,7 mm |
| 18-523-09-01 | 130 mm  | Ø 3,0 mm |
| 18-523-10-01 | 130 mm  | Ø 3,3 mm |
| 18-523-11-01 | 130 mm  | Ø 3,6 mm |
| 18-523-12-01 | 130 mm  | Ø 4,0 mm |
| 18-523-13-01 | 130 mm  | Ø 5,0 mm |

## Sauger, Saugrohre

Suction cannulas, Suction Tubes

Cánulas de aspiración, Tubos de aspiración

Canules d'aspiration, Tubes d'aspiration

Cannule di'aspirazione, Tubi di aspirazione

## Sauger, Kanülen

Suction Tubes, Cannulas

Tubos de Aspiración, Cánulas

Tubes d'aspiration, Canules

Tubi d'aspirazione, Cannule

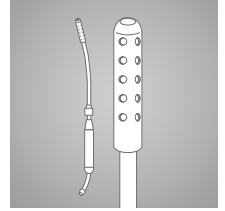

1/2

Fergusson  
18-524-15-01 -  
18-524-50-01

|              | Arbeitslänge<br>working length<br>largo útil<br>longueur utile<br>lunghezza utile |          |
|--------------|---|----------|
| 18-524-15-01 | 110 mm  | Ø 1,5 mm |
| 18-524-20-01 | 110 mm  | Ø 2,0 mm |
| 18-524-25-01 | 110 mm  | Ø 2,5 mm |
| 18-524-30-01 | 110 mm  | Ø 3,0 mm |
| 18-524-40-01 | 110 mm  | Ø 4,0 mm |
| 18-524-50-01 | 110 mm  | Ø 5,0 mm |



1/2

Fergusson  
18-524-60-01 -  
18-524-65-01

|              | Arbeitslänge<br>working length<br>largo útil<br>longueur utile<br>lunghezza utile |          |
|--------------|---|----------|
| 18-524-60-01 | 130 mm  | Ø 1,5 mm |
| 18-524-61-01 | 130 mm  | Ø 2,0 mm |
| 18-524-62-01 | 130 mm  | Ø 2,5 mm |
| 18-524-63-01 | 130 mm  | Ø 3,0 mm |
| 18-524-64-01 | 130 mm  | Ø 4,0 mm |
| 18-524-65-01 | 130 mm  | Ø 5,0 mm |

## Sauger, Saugrohre

Suction cannulas, Suction Tubes

Cánulas de aspiración, Tubos de aspiración

Canules d'aspiration, Tubes d'aspiration

Cannule di'aspirazione, Tubi di aspirazione



1/2

Fergusson  
18-524-70-01 -  
18-524-75-01

|              | Arbeitslänge<br>working length<br>largo útil<br>longueur utile<br>lunghezza utile |          |
|--------------|---|----------|
| 18-524-70-01 | 160 mm  | Ø 1,5 mm |
| 18-524-71-01 | 160 mm  | Ø 2,0 mm |
| 18-524-72-01 | 160 mm  | Ø 2,5 mm |
| 18-524-73-01 | 160 mm  | Ø 3,0 mm |
| 18-524-74-01 | 160 mm  | Ø 4,0 mm |
| 18-524-75-01 | 160 mm  | Ø 5,0 mm |



1/2

Fergusson  
18-524-80-01 -  
18-524-85-01

|              | Arbeitslänge<br>working length<br>largo útil<br>longueur utile<br>lunghezza utile |          |
|--------------|---|----------|
| 18-524-80-01 | 200 mm  | Ø 1,5 mm |
| 18-524-81-01 | 200 mm  | Ø 2,0 mm |
| 18-524-82-01 | 200 mm  | Ø 2,5 mm |
| 18-524-83-01 | 200 mm  | Ø 3,0 mm |
| 18-524-84-01 | 200 mm  | Ø 4,0 mm |
| 18-524-85-01 | 200 mm  | Ø 5,0 mm |

## Sauger, Saugrohre

Suction cannulas, Suction Tubes

Cánulas de aspiración, Tubos de aspiración

Canules d'aspiration, Tubes d'aspiration

Cannule di'aspirazione, Tubi di aspirazione

## Sauger, Kanülen

Suction Tubes, Cannulas

Tubos de Aspiración, Cánulas

Tubes d'aspiration, Canules

Tubi d'aspirazione, Cannule

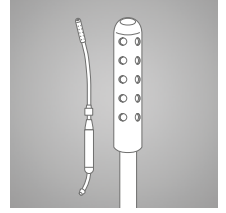

1/2

Poppen  
18-525-06-01 -  
18-525-12-01

|              | Arbeitslänge<br>working length<br>largo útil<br>longueur utile<br>lunghezza utile |          |
|--------------|---|----------|
| 18-525-06-01 | 90 mm   | Ø 2,0 mm |
| 18-525-08-01 | 90 mm   | Ø 2,6 mm |
| 18-525-10-01 | 90 mm   | Ø 3,3 mm |
| 18-525-12-01 | 90 mm   | Ø 4,0 mm |

## Sauger, Saugrohre

Suction cannulas, Suction Tubes  
 Cánulas de aspiración, Tubos de aspiración  
 Canules d'aspiration, Tubes d'aspiration  
 Cannule di'aspirazione, Tubi di aspirazione



1/2

|              |  |
|--------------|--|
|              | Saugaufsatz<br>Suction tip<br>Punta de succión<br>Pointe de succion<br>Punta per aspirazione |
| 18-526-07-01 | Ø 0,7 mm   |
| 18-526-09-01 | Ø 0,9 mm   |



18-526-00-01

Zoellner  
18-526-00-01

Saugkanüle, allein  
Suction cannula, only  
Tubo de aspiración, solo  
Tube d'aspiration, seul  
Tubo di aspirazione, solo



1/2

Zoellner  
18-526-17-01

Saugspitze  
suction tip  
punta de succión  
pointe de succion  
punta per aspirazione



18-526-00-01



1/2

Ø 2,3 mm  
Wullstein  
18-527-00-01

14 cm / 5 4/8"  
komplett mit Griff und drei Aufsätzen  
complete, with handle and 3 tips  
completo, con mango y 3 puntas  
complet, avec manche et 3 pointes  
completo, con manico e 3 punte



1/1

18-527-04-01 - 18-527-08-01

4,5 cm / 1 5/8"  
Mikro-Saugkanüle  
Micro suction cannula  
Micro-tubo de aspiración  
Micro-tube d'aspiration  
Micro-tubo di aspirazione

|              |          |
|--------------|----------|
| 18-527-04-01 | Ø 0,4 mm |
| 18-527-06-01 | Ø 0,6 mm |
| 18-527-08-01 | Ø 0,8 mm |

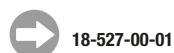

18-527-00-01



1/2

Ø 2,5 mm  
Wullstein  
18-527-01-01

14 cm / 5 4/8"  
Handgriff mit Rohr, allein  
Handle with tube, only  
Mango con tubo, solo  
Manche avec tube, seul  
Manico con tubo, solo



## Sauger, Saugrohre

Suction cannulas, Suction Tubes  
 Cánulas de aspiración, Tubos de aspiración  
 Canules d'aspiration, Tubes d'aspiration  
 Cannule di aspirazione, Tubi di aspirazione

## Sauger, Kanülen

Suction Tubes, Cannulas  
 Tubos de Aspiración, Cánulas  
 Tubes d'aspiration, Canules  
 Tubi d'aspirazione, Cannule

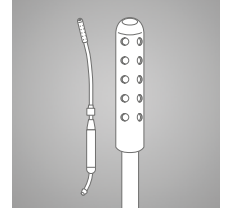

1/2

|              | Arbeitslänge<br>working length<br>largo útil<br>longueur utile<br>lunghezza utile |          |
|--------------|---|----------|
| 18-528-10-01 | 75 mm   | Ø 1,0 mm |
| 18-528-15-01 | 75 mm   | Ø 1,5 mm |
| 18-528-20-01 | 75 mm   | Ø 2,0 mm |

## Baron-Schuknecht

18-528-10-01 -  
 18-528-20-01

mit Unterbrecher  
 with finger cut-off  
 con placa interruptor  
 avec plaque interrupteur  
 con placa interruttore



1/2

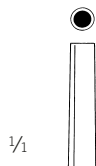

**Ø 3,0 mm**  
 18-529-30-07  
 16,5 cm / 6 4/8"  
 Arbeitslänge  
 working length  
 largo útil  
 longueur utile  
 lunghezza utile  
**110 mm**

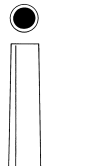

**Ø 3,5 mm**  
 18-529-35-07  
 16,5 cm / 6 4/8"  
 Arbeitslänge  
 working length  
 largo útil  
 longueur utile  
 lunghezza utile  
**110 mm**



**Ø 4,5 mm**  
 18-529-45-07  
 18 cm / 7 4/8"  
 Arbeitslänge  
 working length  
 largo útil  
 longueur utile  
 lunghezza utile  
**130 mm**



1/2

## Luer

18-529-30-07 -  
 18-529-45-07

konisch  
 conical  
 cónico  
 conique  
 conico

18-531-01-07

Saughandgriff für Tonsillenkanüle  
 Suction handle for tonsil cannula

Mango de aspiración para  
 cánula para amígdalas

Poignée d'aspiration pour  
 aiguille pour amygdales

Impugnatura di aspirazione  
 per cannula per tonsille



18-640-20-07,  
 18-641-20-07,  
 18-642-20-07

## Sauger, Saugrohre

Suction cannulas, Suction Tubes

Cánulas de aspiración, Tubos de aspiración

Canules d'aspiration, Tubes d'aspiration

Cannule di aspirazione, Tubi di aspirazione



1/2



1/2



1/2

Magill  
18-541-99-01

Reinigungsdraht  
Cleaning wire  
Filo de pulizia  
Tige de nettoyage  
Alambre de limpieza

**Ø 3,2 mm**

Landolt

18-533-01-07

25 cm / 9 7/8"

Sauger für Hypophyse

Suction tube for pituitary

Aspirador para pituitaria

Tube d'aspiration pour hypophyse

Tubo di aspirazione per ipofisi

Yasargil

18-540-15-01 -

18-540-20-01 -

18-540-25-01 -

18-540-35-01

17 cm / 6 5/8"

|              | Arbeitslänge<br>working length<br>largo útil<br>longueur utile<br>lunghezza utile |          |
|--------------|---|----------|
| 18-540-15-01 | 150 mm  | Ø 1,5 mm |
| 18-540-20-01 | 150 mm  | Ø 2,0 mm |
| 18-540-25-01 | 150 mm  | Ø 2,5 mm |
| 18-540-35-01 | 150 mm  | Ø 3,5 mm |

Magill

18-541-30-01 -

18-541-35-01 -

18-541-40-01

24,5 cm / 9 5/8"

|              | Arbeitslänge<br>working length<br>largo útil<br>longueur utile<br>lunghezza utile |          |
|--------------|---|----------|
| 18-541-30-01 | 185 mm  | Ø 3,0 mm |
| 18-541-35-01 | 185 mm  | Ø 3,5 mm |
| 18-541-40-01 | 185 mm  | Ø 4,0 mm |

## Sauger, Saugrohre

Suction cannulas, Suction Tubes

Cánulas de aspiración, Tubos de aspiración

Canules d'aspiration, Tubes d'aspiration

Cannule di aspirazione, Tubi di aspirazione

## Sauger, Kanülen

Suction Tubes, Cannulas

Tubos de Aspiración, Cánulas

Tubes d'aspiration, Canules

Tubi d'aspirazione, Cannule

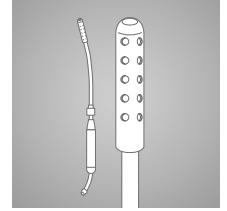

18-543-99-98

Saugkopf allein  
Suction head, only  
Cabezal aspirador solo  
Tête de succion unique  
Testa aspirazione singola



18-542-99-98

Saugkopf allein  
Suction head, only  
Cabezal aspirador solo  
Tête de succion unique  
Testa aspirazione singola



1/2

1/2

1/2

1/2

1/2

**Ø 8,0 mm**  
Baby-Yankauer  
18-542-21-01  
21 cm / 8 2/8"

**Ø 9,4 mm**  
Yankauer  
18-543-27-01  
31 cm / 12 2/8"  
komplett, mit Saugspitze  
und Schlaucholive  
complete, with suction tip  
and connector  
completo, con punta de succión  
et raccord  
complet, avec pointe de succion  
et raccord  
completi, con punte d'aspirazione  
e raccordo

**Ø 4,0 mm**  
De Bakey-Adson  
18-544-16-07  
16 cm / 6 2/8"

**Ø 4,0 mm**  
De Bakey-Adson  
18-544-20-07  
20 cm / 7 7/8"

**Ø 9,0 mm**  
De Bakey-Adson  
18-544-28-07  
28 cm / 6 2/8"

## Sauger, Saugrohre

Suction cannulas, Suction Tubes

Cánulas de aspiración, Tubos de aspiración

Canules d'aspiration, Tubes d'aspiration

Cannule di aspirazione, Tubi di aspirazione



1/2

Ø 2,5 mm

Fig. 0

18-545-10-01

10 cm / 3 7/8"

Ø 3,4 mm

Fig. 1

18-545-11-01

10 cm / 3 7/8"

Ø 4,3 mm

Fig. 2

18-545-12-01

10 cm / 3 7/8"

Ø 6,0 mm

Fig. 3

18-545-13-01

13,5 cm / 5 3/8"

1/2

1/2

1/2

1/2

### Yankauer

18-545-00-01

31 cm / 12 2/8"

komplett, mit Griff, 4 Saugrohren Fig. 0/1/2/3, Saugspitze und Schlaucholive

complete, with handle, 4 tubes fig. 0/1/2/3, suction tip and tube connector

completo, con mango, 4 tubos, fig. 0/1/2/3, punta de succión y conector para tubos

complet, avec manche, 4 tubes, fig. 0/1/2/3, pointe de succion et raccord ou tubes

completi, con manico, 4 tubi, fig. 0/1/2/3, punta per aspirazione e raccordo per tubi

18-545-00-01

Set bestehend aus:

Set consisting of:

Juego formado por:

Set composé de:

Set composto da:

18-545-01-01

18-545-02-01

18-545-10-01

18-545-11-01

18-545-12-01

18-545-13-01

18-545-15-01

18-545-01-01

15 cm / 5 7/8"

Handgriff

Handle

Mango

Manche

Manico

18-545-02-01

2,5 cm / 1"

Schlaucholive

Olive

Olive

Olive

Oliva

Ø 9,9 mm

18-545-15-01

Saugspitze

suction tip

punta de succión

pointe de succion

punta per aspirazione

## Sauger, Saugrohre

Suction cannulas, Suction Tubes

Cánulas de aspiración, Tubos de aspiración

Canules d'aspiration, Tubes d'aspiration

Cannule di'aspirazione, Tubi di aspirazione

## Sauger, Kanülen

Suction Tubes, Cannulas

Tubos de Aspiración, Cánulas

Tubes d'aspiration, Canules

Tubi d'aspirazione, Cannule

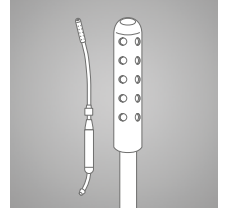

1/2

Baby-Poole  
18-548-19-01  
19 cm / 7 4/8"  
Ø 6 mm



1/2

Baby-Poole  
18-549-19-01  
19 cm / 7 4/8"  
Ø 6 mm



1/2

Poole  
18-550-22-01  
24 cm / 9 4/8"  
Ø 10 mm



1/2

Poole  
18-551-22-01  
25 cm / 9 7/8"  
Ø 8 mm

## Sauger, Saugrohre

Suction cannulas, Suction Tubes

Cánulas de aspiración, Tubos de aspiración

Canules d'aspiration, Tubes d'aspiration

Cannule di'aspirazione, Tubi di aspirazione



|              | Saugrohr<br>Suction tube<br>Tubo de aspiración<br>Tube d'aspiration<br>Tubo di aspirazione | Spülrohr<br>Irrigation tube<br>Tubo de irrigación<br>Tube d'irrigation<br>Tubo d'irrigazione |
|--------------|--|--|
| 18-553-09-07 | <b>Ø 0,9 mm</b>  | <b>Ø 0,7 mm</b>  |
| 18-554-09-07 | <b>Ø 1,2 mm</b>  | <b>Ø 0,9 mm</b>  |
| 18-555-09-07 | <b>Ø 1,5 mm</b>  | <b>Ø 1,2 mm</b>  |



House  
18-553-09-07 -  
18-555-09-07

17 cm / 6 5/8"

Saugrohr  
Suction tube  
Tubo de aspiración  
Tube d'aspiration  
Tubo di aspirazione

House  
18-556-06-07

4,5 cm / 1 5/8"

Saugadapter  
Suction adapter  
Adaptador de aspiración  
Adaptateur d'aspiration  
Adattatore di aspirazione

## Sauger, Saugrohre

Suction cannulas, Suction Tubes

Cánulas de aspiración, Tubos de aspiración

Canules d'aspiration, Tubes d'aspiration

Cannule di'aspirazione, Tubi di aspirazione

## Saugen und Spülen

Suction and irrigation

Aspiración y irrigación

Aspiration et irrigation

Aspirazione e irrigazione

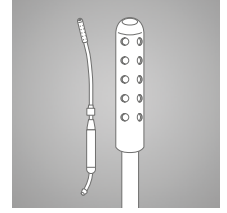

1/2

Fukushima

18-557-03-01 -

18-557-12-01

16 cm / 6 2/8"

|              | Arbeitslänge<br>working length<br>largo útil<br>longueur utile<br>lunghezza utile |          |
|--------------|---|----------|
| 18-557-03-01 | 100 mm  | Ø 1,0 mm |
| 18-557-04-01 | 100 mm  | Ø 1,3 mm |
| 18-557-05-01 | 100 mm  | Ø 1,7 mm |
| 18-557-06-01 | 100 mm  | Ø 2,0 mm |
| 18-557-07-01 | 100 mm  | Ø 2,3 mm |
| 18-557-08-01 | 100 mm  | Ø 2,7 mm |
| 18-557-09-01 | 100 mm  | Ø 3,0 mm |
| 18-557-10-01 | 100 mm  | Ø 3,3 mm |
| 18-557-12-01 | 100 mm  | Ø 4,0 mm |



1/2

Fukushima

18-558-03-01 -

18-558-12-01

18 cm / 7 1/8"

|              | Arbeitslänge<br>working length<br>largo útil<br>longueur utile<br>lunghezza utile |          |
|--------------|---|----------|
| 18-558-03-01 | 115 mm  | Ø 1,0 mm |
| 18-558-04-01 | 115 mm  | Ø 1,3 mm |
| 18-558-05-01 | 115 mm  | Ø 1,7 mm |
| 18-558-06-01 | 115 mm  | Ø 2,0 mm |
| 18-558-07-01 | 115 mm  | Ø 2,3 mm |
| 18-558-08-01 | 115 mm  | Ø 2,7 mm |
| 18-558-09-01 | 115 mm  | Ø 3,0 mm |
| 18-558-10-01 | 115 mm  | Ø 3,3 mm |
| 18-558-12-01 | 115 mm  | Ø 4,0 mm |

## Sauger, Saugrohre

Suction cannulas, Suction Tubes

Cánulas de aspiración, Tubos de aspiración

Canules d'aspiration, Tubes d'aspiration

Cannule di aspirazione, Tubi di aspirazione



1/2

Fukushima

18-559-03-01 -

18-559-12-01

20,5 cm / 8 1/8"

|              | Arbeitslänge<br>working length<br>largo útil<br>longueur utile<br>lunghezza utile |          |
|--------------|---|----------|
| 18-559-03-01 | 140 mm  | Ø 1,0 mm |
| 18-559-04-01 | 140 mm  | Ø 1,3 mm |
| 18-559-05-01 | 140 mm  | Ø 1,7 mm |
| 18-559-06-01 | 140 mm  | Ø 2,0 mm |
| 18-559-07-01 | 140 mm  | Ø 2,3 mm |
| 18-559-08-01 | 140 mm  | Ø 2,7 mm |
| 18-559-09-01 | 140 mm  | Ø 3,0 mm |
| 18-559-10-01 | 140 mm  | Ø 3,3 mm |
| 18-559-12-01 | 140 mm  | Ø 4,0 mm |



1/2

Fukushima

18-560-03-01 -

18-560-12-01

23 cm / 9"

|              | Arbeitslänge<br>working length<br>largo útil<br>longueur utile<br>lunghezza utile |          |
|--------------|---|----------|
| 18-560-03-01 | 165 mm  | Ø 1,0 mm |
| 18-560-04-01 | 165 mm  | Ø 1,3 mm |
| 18-560-05-01 | 165 mm  | Ø 1,7 mm |
| 18-560-06-01 | 165 mm  | Ø 2,0 mm |
| 18-560-07-01 | 165 mm  | Ø 2,3 mm |
| 18-560-08-01 | 165 mm  | Ø 2,7 mm |
| 18-560-09-01 | 165 mm  | Ø 3,0 mm |
| 18-560-10-01 | 165 mm  | Ø 3,3 mm |
| 18-560-12-01 | 165 mm  | Ø 4,0 mm |



## Sauger, Saugrohre

Suction cannulas, Suction Tubes

Cánulas de aspiración, Tubos de aspiración

Canules d'aspiration, Tubes d'aspiration

Cannule di'aspirazione, Tubi di aspirazione

## Saugen und Spülen

Suction and irrigation

Aspiración y irrigación

Aspiration et irrigation

Aspirazione e irrigazione

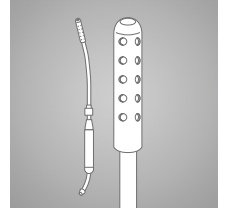

1/2

Cooley  
18-561-35-01  
36 cm / 14 1/8"

**Ø 8 mm**



1/2

Cooley  
18-563-31-01  
31 cm / 12 2/8"

**Ø 10 mm**

mit perforierter Schraubspitze  
with perforated screw tip  
con punta perforada y roscada  
avec pointe perforée et fileté  
con punta perforata e filetta



1/2

Cooley  
18-565-30-01  
31 cm / 12 2/8"

**Ø 7 mm**

mit perforierter Schraubspitze  
with perforated screw tip  
con punta perforada y roscada  
avec pointe perforée et fileté  
con punta perforata e filetta



1/2

Cooley  
18-567-33-01  
36 cm / 14 1/8"

**Ø 8 mm**

mit perforierter Schraubspitze  
with perforated screw tip  
con punta perforada y roscada  
avec pointe perforée et fileté  
con punta perforata e filetta

## Sauger, Saugrohre

Suction cannulas, Suction Tubes

Cánulas de aspiración, Tubos de aspiración

Canules d'aspiration, Tubes d'aspiration

Cannule di'aspirazione, Tubi di aspirazione



**Ø 6 mm**  
Nuboer  
18-569-21-01  
21 cm / 8 2/8"  
runde Öffnung  
round opening  
abertura redonda  
ouverture ronde  
apertura rotonda



**Ø 6 mm**  
Nuboer  
18-571-21-01  
21 cm / 8 2/8"  
ovale Öffnung  
oval opening  
abertura ovalada  
ouverture ovale  
apertura ovale



Jamieson  
18-572-05-07 -  
18-572-15-07  
27 cm / 10 6/8"

|              |                 |
|--------------|-----------------|
| 18-572-05-07 | <b>Ø 0,5 mm</b> |
| 18-572-10-07 | <b>Ø 1,0 mm</b> |
| 18-572-15-07 | <b>Ø 1,5 mm</b> |



Jamieson  
18-573-05-07 -  
18-573-10-07  
27 cm / 10 6/8"

|              |                 |
|--------------|-----------------|
| 18-573-05-07 | <b>Ø 0,5 mm</b> |
| 18-573-10-07 | <b>Ø 1,0 mm</b> |

## Sauger, Saugrohre

Suction cannulas, Suction Tubes

Cánulas de aspiración, Tubos de aspiración

Canules d'aspiration, Tubes d'aspiration

Cannule di aspirazione, Tubi di aspirazione

## Saugen und Spülen

Suction and irrigation

Aspiración y irrigación

Aspiration et irrigation

Aspirazione e irrigazione

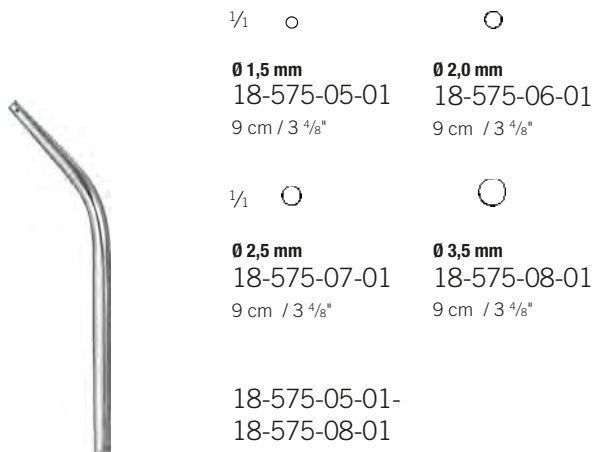
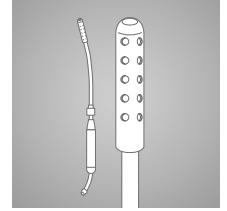

1/1 ○

○

**Ø 1,5 mm**

18-575-05-01

9 cm / 3 4/8"

**Ø 2,0 mm**

18-575-06-01

9 cm / 3 4/8"

1/1 ○

○

**Ø 2,5 mm**

18-575-07-01

9 cm / 3 4/8"

**Ø 3,5 mm**

18-575-08-01

9 cm / 3 4/8"

18-575-05-01-

18-575-08-01

Spitze seitlich perforiert  
tip laterally perforated  
punta perforada lateralmente  
pointe côté perforée  
punta con perforazione laterale



**18-575-24-01**



1/2

Coupland  
18-575-24-01

17 cm / 6 5/8"

Handgriff mit Schlauchansatz  
Handle with connector  
Mango con conexión para tubos  
Manche avec connection pour tubes  
Manico con raccordo per tubi



1/2

Byrd  
18-577-01-01 -  
18-577-03-01

21,5 cm / 8 4/8"

○  
**Ø 3,0 mm**  
18-577-01-01

○  
**Ø 3,5 mm**  
18-577-02-01

1/1 ○  
**Ø 4,3 mm**  
18-577-03-01

## Sauger, Saugrohre

Suction cannulas, Suction Tubes

Cánulas de aspiración, Tubos de aspiración

Canules d'aspiration, Tubes d'aspiration

Cannule di aspirazione, Tubi di aspirazione



1/2

|              |          |
|--------------|----------|
| 18-645-15-07 | Ø 1,5 mm |
| 18-645-20-07 | Ø 2,0 mm |
| 18-645-25-07 | Ø 2,5 mm |
| 18-645-30-07 | Ø 3,0 mm |

Plester

18-645-15-07 -

18-645-30-07

19,5 cm / 7 5/8"

Saugkanüle

Suction cannula

Cánula de aspiración

Canule d'aspiration

Cannula di aspirazione



1/2

|              |        |
|--------------|--------|
| 18-646-16-01 | 1,6 mm |
| 18-646-18-01 | 1,2 mm |
| 18-646-20-01 | 1,0 mm |
| 18-646-22-01 | 0,7 mm |
| 18-646-24-01 | 0,5 mm |

Verhoeven

18-646-18-01 -

18-646-24-01

12 cm / 4 6/8"

Saugkanüle

Suction cannula

Cánula de aspiración

Canule d'aspiration

Cannula di aspirazione



1/2

Ø 1,5 mm

18-647-20-07

16 cm / 6 2/8"

Saugkanüle, biegsam

Suction cannula, malleable

Cánula de aspiración, maleable

Canule d'aspiration, malléable

Cannula di aspirazione, malleabile

## Sauger, Saugrohre

Suction cannulas, Suction Tubes

Cánulas de aspiración, Tubos de aspiración

Canules d'aspiration, Tubes d'aspiration

Cannule di aspirazione, Tubi di aspirazione

## Sauger, Kanülen

Suction Tubes, Cannulas

Tubos de Aspiración, Cánulas

Tubes d'aspiration, Canules

Tubi d'aspirazione, Cannule

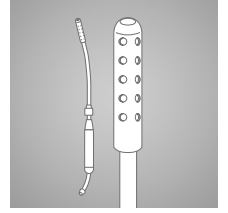

1/2

**Ø 2,0 mm**  
Frazier  
18-636-20-07

7 cm / 2 5/8"

Punktion  
Puncture  
Punción  
Ponction  
Puntura



1/2

**Ø 2,5 mm**  
Frazier  
18-636-25-07

10 cm / 3 7/8"

Punktion  
Puncture  
Punción  
Ponction  
Puntura



1/2

**Ø 2,0 mm**  
Frazier  
18-636-30-07

10 cm / 3 7/8"

Punktion  
Puncture  
Punción  
Ponction  
Puntura



1/2

**Ø 2,0 mm**  
Dandy  
18-638-20-07

9,5 cm / 3 5/8"



1/2

**Ø 2,0 mm**  
Cushing-Cairns  
18-639-23-07

10 cm / 3 7/8"



1/2

**Ø 1,5 mm**  
18-647-20-07

16 cm / 6 2/8"

Saugkanüle, biegsam  
Suction cannula, malleable  
Cánula de aspiración, maleable  
Canule d'aspiration, malléable  
Cannula di aspirazione, malleabile



1/2

Rosen  
18-649-05-01-  
18-649-30-01

9,5 cm / 3 5/8"

|              |                 |
|--------------|-----------------|
| 18-649-05-01 | <b>Ø 0,5 mm</b> |
| 18-649-07-01 | <b>Ø 0,7 mm</b> |
| 18-649-08-01 | <b>Ø 0,8 mm</b> |
| 18-649-09-01 | <b>Ø 0,9 mm</b> |
| 18-649-10-01 | <b>Ø 1,0 mm</b> |
| 18-649-12-01 | <b>Ø 1,2 mm</b> |
| 18-649-14-01 | <b>Ø 1,4 mm</b> |
| 18-649-15-01 | <b>Ø 1,5 mm</b> |
| 18-649-18-01 | <b>Ø 1,8 mm</b> |
| 18-649-20-01 | <b>Ø 2,0 mm</b> |
| 18-649-25-01 | <b>Ø 2,5 mm</b> |
| 18-649-30-01 | <b>Ø 3,0 mm</b> |



Naht  
Suture  
Sutura  
Suture  
Sutura

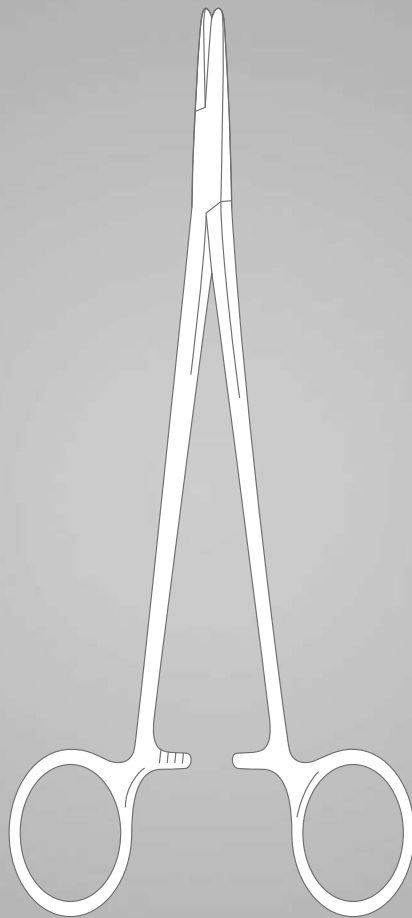

# Nadelhalter

Needle Holders

Porta-agujas

Porte-aiguilles

Portaghi

## TC GOLD



Webster  
20-630-13-07  
13 cm / 5 1/8"



Kilner  
20-631-13-07  
14,5 cm / 5 9/16"

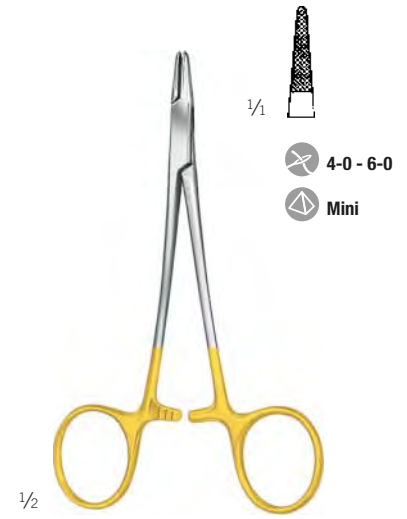

Derf  
20-632-12-07  
12 cm / 4 9/16"



Hegar-Baumgartner  
20-634-13-07 -  
20-634-14-07



Halsey  
20-636-13-07 -  
20-637-13-07  
13 cm / 5 1/8"



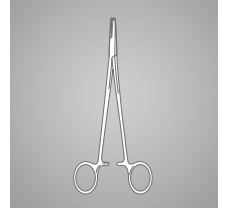

**TC GOLD**

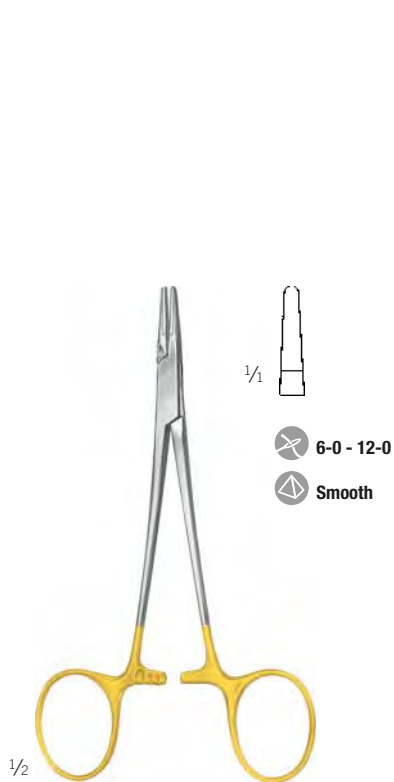

Webster  
 20-637-12-07  
 12 cm / 4 5/8"

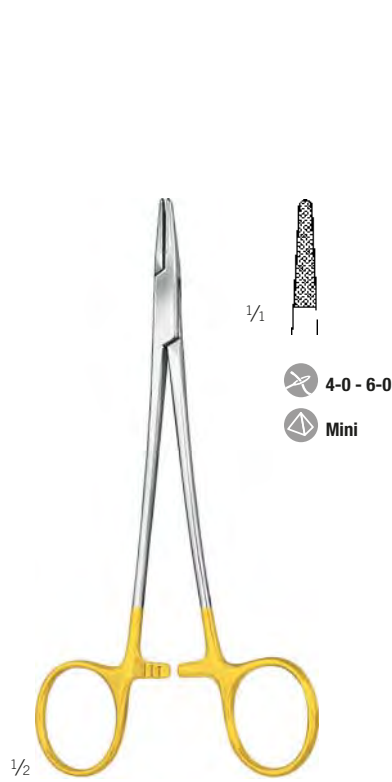

Crile-Wood  
 20-638-15-07  
 15 cm / 5 7/8"



Crile-Wood  
 20-638-20-07  
 20,5 cm / 8 1/8"

# Nadelhalter

Needle Holders

Porta-agujas

Porte-aiguilles

Portaghi

## TC GOLD



1/2

Sarot  
20-640-18-07 -  
20-640-26-07



20-640-18-07  
18 cm / 7 1/8"



20-640-20-07  
20 cm / 7 7/8"



20-640-26-07  
26 cm / 10 2/8"



1/2

Mayo-Hegar  
20-642-16-07 - 20-642-30-07



20-642-16-07  
16 cm / 6 2/8"



20-642-18-07  
18,5 cm / 7 2/8"



20-642-20-07  
20 cm / 7 7/8"



20-642-24-07  
24 cm / 9 4/8"



20-642-26-07  
26,5 cm / 10 3/8"



20-642-30-07  
30 cm / 11 6/8"



# Nadelhalter

Needle Holders  
Porta-agujas  
Porte-aiguilles  
Portaghi

# Naht

Suture  
Sutura  
Suture  
Sutura



## TC GOLD



1/2

Heaney  
20-643-20-07 -  
20-643-26-07



1/1

20-643-20-07  
20,5 cm / 8 1/8"



Standard



20-643-24-07  
24 cm / 9 4/8"



Standard



20-643-26-07  
26,5 cm / 10 3/8"



Standard



1/2

DeBaKey  
20-646-18-07 - 20-646-31-07

schlankes Model  
slender pattern  
modelo delgado  
modèle gracile  
modello delicato

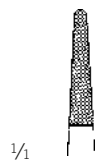

1/1

20-646-18-07  
18 cm / 7 1/8"



Mini



20-646-20-07  
20,5 cm / 8 1/8"



Mini



20-646-23-07  
23 cm / 9 "



Mini



1/1

20-646-26-07  
26,5 cm / 10 3/8"



Mini



20-646-31-07  
31 cm / 12 2/8"



Mini

# Nadelhalter

Needle Holders

Porta-agujas

Porte-aiguilles

Portaghi

## TC GOLD

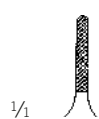

20-650-13-07  
12,5 cm / 4 7/8"



20-650-15-07  
15 cm / 5 7/8"



20-650-18-07  
18 cm / 7 1/8"



20-650-20-07  
20 cm / 7 7/8"



20-650-23-07  
23 cm / 9"



20-650-26-07  
26 cm / 10 2/8"



Ryder (Martin)  
20-650-13-07 -  
20-650-26-07

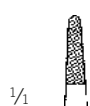

20-652-15-07  
15 cm / 5 7/8"



20-652-17-07  
17 cm / 6 5/8"



20-652-20-07  
20,5 cm / 8 1/8"



Martin  
20-652-15-07 -  
20-652-20-07

elastisches Modell  
elastic tip  
modelo elástico  
modèle souple  
modello molle



**TC GOLD**



1/2

Martini  
20-668-00-07 -  
20-668-03-07



20-668-00-07

14 cm / 5 4/8"



5-0 - 8-0  
Smooth



20-668-01-07

15 cm / 5 7/8"



5-0 - 8-0  
Smooth



20-668-02-07

17,5 cm / 6 7/8"



5-0 - 8-0  
Smooth

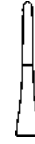

20-668-03-07

20 cm / 7 7/8"



5-0 - 8-0  
Smooth



1/2

Martini  
20-670-00-07 -  
20-670-03-07

schlankes Modell  
delicate pattern  
modelo delgado  
modèle gracile  
modelo gracile

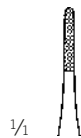

20-670-00-07

14 cm / 5 4/8"



5-0 - 8-0  
Micro



20-670-01-07

15 cm / 5 7/8"



5-0 - 8-0  
Micro



20-670-02-07

17,5 cm / 6 7/8"



5-0 - 8-0  
Micro



20-670-03-07

20 cm / 7 7/8"



5-0 - 8-0  
Micro



Knochenchirurgie  
Bone Surgery  
Cirugía ósea  
Chirurgie osseuse  
Chirurgia ossea

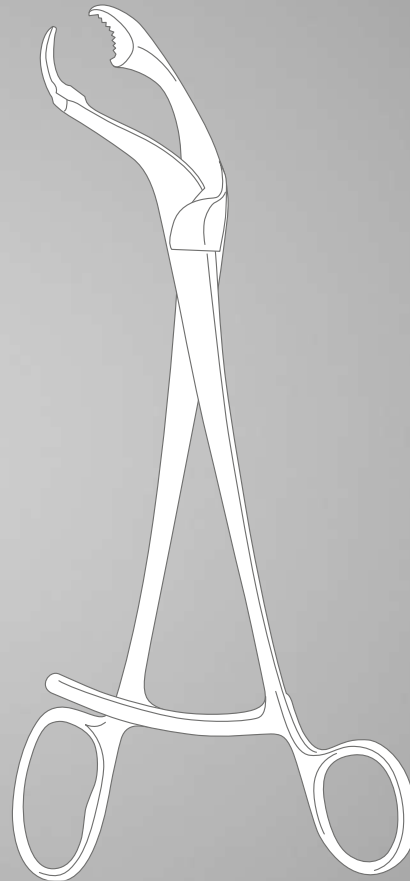
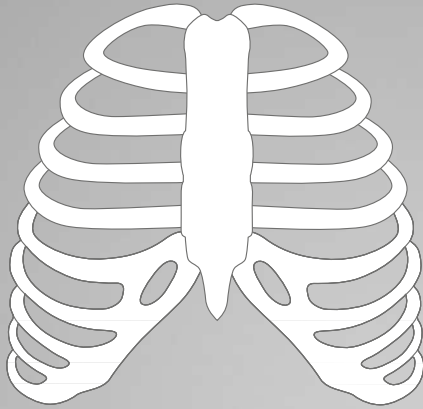

# Handbohrapparate

Hand Drills

Perforadores de mano

Perforateurs à main

Perforatori a mano



1/3

**Fig. 1**  
22-152-01-07



Kegelfräser  
Conical burr  
Fresa cónica  
Fraise conique  
Fresa cuneiforme



**Fig. 2**  
22-152-02-07



Kegelfräser  
Conical burr  
Fresa cónica  
Fraise conique  
Fresa cuneiforme



**Fig. 3**  
22-152-03-07



Kugelfräser  
Spherical burr  
Fresa esférica  
Fraise sphérique  
Fresa sferica



**Fig. 4**  
22-152-04-07



Kugelfräser  
Spherical burr  
Fresa esférica  
Fraise sphérique  
Fresa sferica



1/3

**Hudson**  
22-152-00-07

28 cm / 11 "

komplett, mit Fräsern Fig. 1 - 4  
und Verlängerungsstück

complete, with burrs no. 1 - 4  
and extension piece

completo, con fresas no. 1 - 4  
y pieza de extensión

complet, avec fraises no. 1 - 4  
et pièce de rallonge

completo, con frese no. 1 - 4  
e giunto di prolungamento



1/3

**Fig. 5**  
22-152-05-07



Flachfräser  
Flat burr  
Taladro cónica  
Fraise conique  
Trapano cuneiforme



**Fig. 6**  
22-152-06-07



Spiralbohrer  
Twist drill  
Broca espiral  
Mèche hélicoïdale  
Punta a spirale



**Fig. 7**  
22-152-07-07



Bohrer  
Burr  
Fresa  
Fraise  
Punta



**Fig. 8**  
22-152-08-07



Bohrer  
Burr  
Fresa  
Fraise  
Punta



**Fig. 9**  
22-152-09-07



Verlängerungsstück  
Extension piece  
Pieza de prolongación  
Pièce de rallonge  
Giunto di prolungamento



# Hohlmeißel, Flachmeißel, Osteotome

Gouges, Chisels, Osteotomes  
 Gubias, Cinceles, Osteótomos  
 Gouges, Ciseaux-burins, Ostéotomes  
 Sgorbie, Scalpelli, Osteotomi

# Knochenchirurgie

Bone Surgery  
 Cirugía ósea  
 Chirurgie osseuse  
 Chirurgia ossea

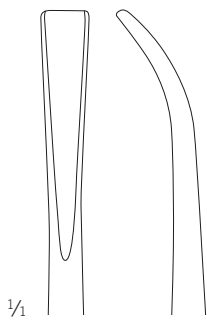
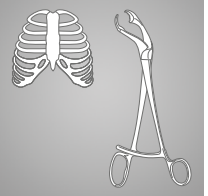

5,5 mm  
23-112-05-04

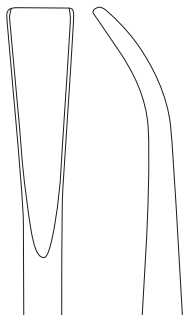

9 mm  
23-112-09-04



1/2

Zielke  
 23-112-05-04 -  
 23-112-09-04  
 23 cm / 9"

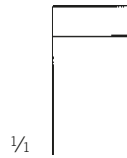

1/1  
 10 mm  
 23-123-10-07

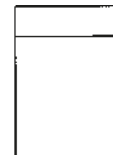

12 mm  
 23-123-12-07



15 mm  
 23-123-15-07

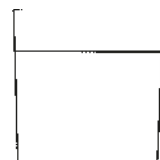

20 mm  
 23-123-20-07

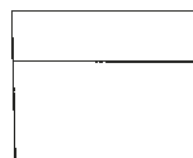

25 mm  
 23-123-25-07



1/2

Stille  
 23-123-10-07 -  
 23-123-25-07  
 20,5 cm / 8 1/8"



1/1  
 8 mm  
 23-124-08-07



10 mm  
 23-124-10-07



12 mm  
 23-124-12-07



15 mm  
 23-124-15-07

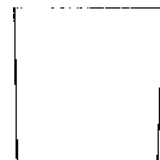

20 mm  
 23-124-20-07

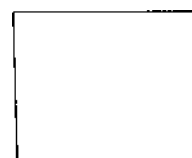

25 mm  
 23-124-25-07



1/2

Stille  
 23-124-08-07 -  
 23-124-25-07  
 20,5 cm / 8 1/8"

# Flachmeißel, Hohlmeißel

Chisels, Gouges  
 Cinceles, Gubias  
 Ciseaux-burins, Gouges  
 Scalpelli, Sgorbie

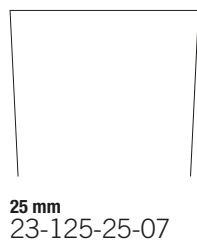
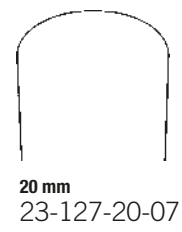
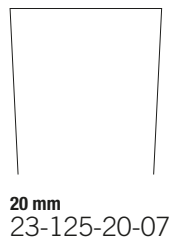
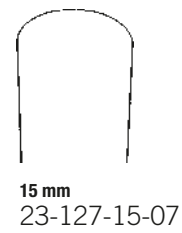
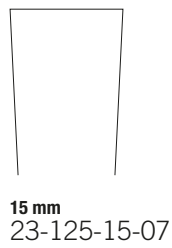
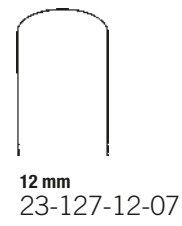
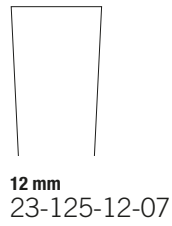
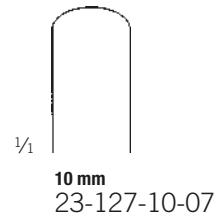
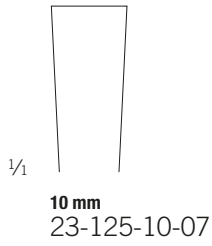

Stille  
 23-125-10-07 -  
 23-125-25-07  
 20,5 cm / 8 1/8"

Stille  
 23-127-10-07 -  
 23-127-25-07  
 20,5 cm / 8 1/8"

fein  
 delicate  
 fino  
 fin  
 fino

## Meißelklingen, Meißelgriff

Chisel Blades, Chisel Handle

Hojas de cincel, Mango para hojas de cincel

Lames-gouges, Manche pour ciseaux-burins

Lame per sgorbie, Manico per scalpello

## Knochenchirurgie

Bone Surgery

Cirugía ósea

Chirurgie osseuse

Chirurgia ossea

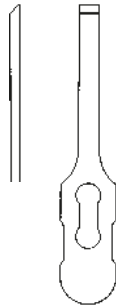
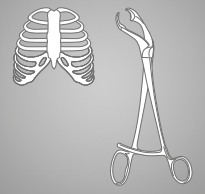

**5 mm**  
23-130-05-07  
8 cm / 3 1/8"



**10 mm**  
23-130-10-07  
8 cm / 3 1/8"



**16 mm**  
23-130-16-07  
8 cm / 3 1/8"

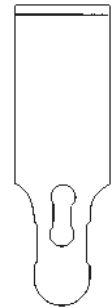

**25 mm**  
23-130-25-07  
8 cm / 3 1/8"



### 23-130-90-98

Halteschraube

Spare Screw

Tornillo de repuesto

Vis de rechange

Vite di ricambio



### 23-130-99-07

Spannschlüssel

Key

Llave

Clé

Chiave



Osteotomklingen, auswechselbar  
Osteotome blades, interchangeable  
Hojas de osteótomo, intercambiables  
Lame per osteotomia, intercambiabili  
Lame per osteotomia, intercambiabili

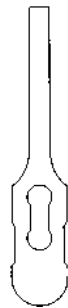

**5 mm**  
23-130-55-07  
8 cm / 3 1/8"



**10 mm**  
23-130-60-07  
8 cm / 3 1/8"



**16 mm**  
23-130-66-07  
8 cm / 3 1/8"

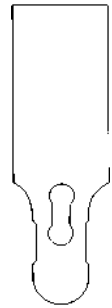

**25 mm**  
23-130-85-07  
8 cm / 3 1/8"



1/2

23-130-00-04

18,5 cm / 7 2/8"



## Osteotome, Hohlmeißel

Osteotomes, Gouges

Osteótomos, Gubias

Ostéotomes, Gouges

Osteotomi, Sgorbie

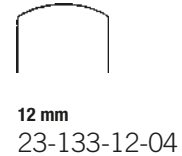
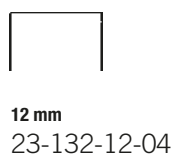
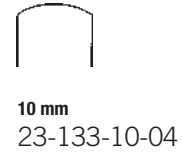
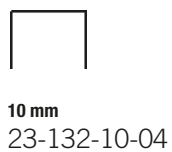
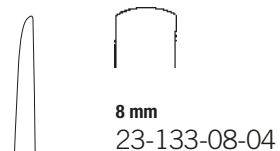
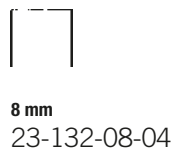
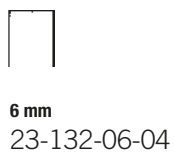

Lexer-Mini  
23-132-04-04 -  
23-132-12-04  
18 cm / 7 1/8"



Lexer-Mini  
23-133-04-04 -  
23-133-12-04  
18 cm / 7 1/8"



## Osteotome, Hohlmeißel

Osteotomes, Gouges  
Osteótomos, Gubias  
Ostéotomes, Gouges  
Osteotomi, Sgorbie

## Knochenchirurgie

Bone Surgery  
Cirugía ósea  
Chirurgie osseuse  
Chirurgia ossea

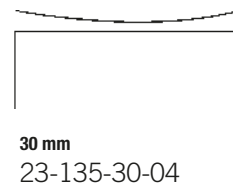
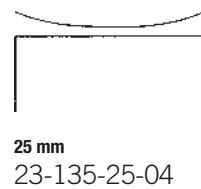
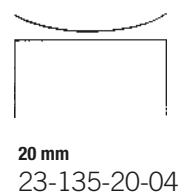
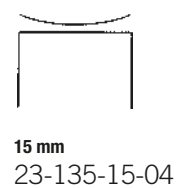
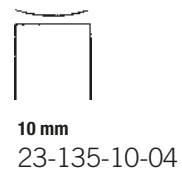
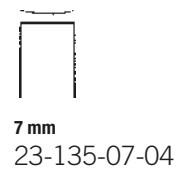
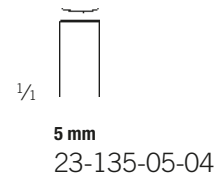
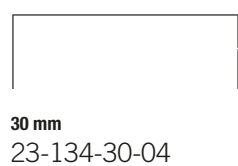
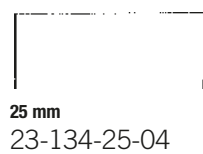
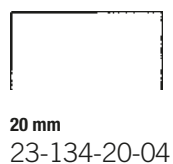
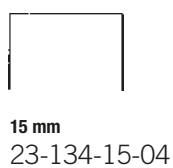
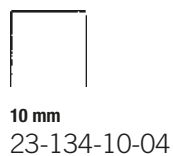
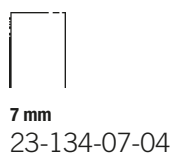
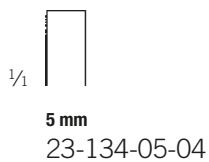
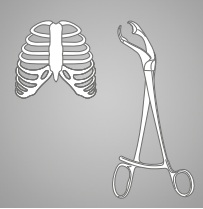

Lexer  
23-134-05-04 -  
23-134-30-04  
22 cm / 8 5/8"



Lexer  
23-135-05-04 -  
23-135-30-04  
22 cm / 8 5/8"



# Osteotome

Osteotomes

Osteótomos

Ostéotomes

Osteotomi



**2 mm**  
23-136-02-07



**3 mm**  
23-136-03-07



**4 mm**  
23-136-04-07



**6 mm**  
23-136-06-07



**8 mm**  
23-136-08-07



**10 mm**  
23-136-10-07



**12 mm**  
23-136-12-07



**15 mm**  
23-136-15-07



**3 mm**  
23-136-53-07



**4 mm**  
23-136-54-07



**6 mm**  
23-136-56-07



**8 mm**  
23-136-58-07



**10 mm**  
23-136-60-07



**12 mm**  
23-136-62-07



**15 mm**  
23-136-65-07



Lambotte-Mini  
23-136-02-07 -  
23-136-15-07  
12,5 cm / 4 7/8"



Lambotte-Mini  
23-136-53-07 -  
23-136-65-07  
17 cm / 6 5/8"









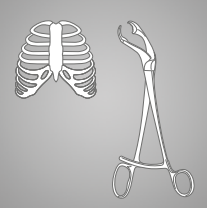

# Osteotome

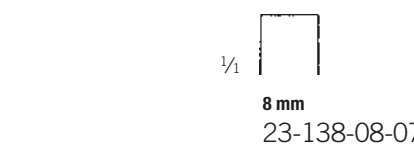
Osteotomes  
Osteótomos  
Ostéotomes  
Osteotomi

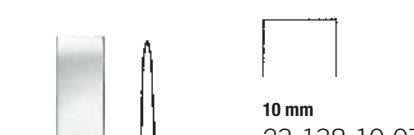
# Knochenchirurgie

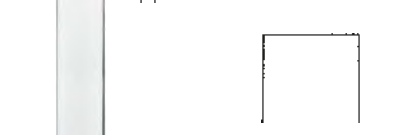
Bone Surgery  
Cirugía ósea  
Chirurgie osseuse  
Chirurgia ossea

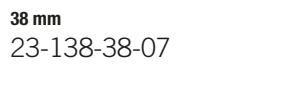
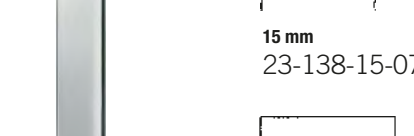

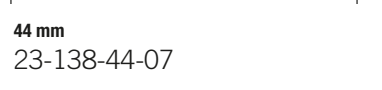
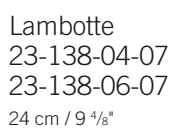
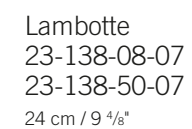
|  |  |   |   |
|--|--|---|---|
|  <p><math>\frac{1}{2}</math><br/>4 mm<br/>23-138-04-07</p>   |  <p><math>\frac{1}{2}</math><br/>6 mm<br/>23-138-06-07</p>   |  <p><math>\frac{1}{4}</math><br/>8 mm<br/>23-138-08-07</p> |  <p>25 mm<br/>23-138-25-07</p>   |
|  |  |  <p>10 mm<br/>23-138-10-07</p>                            |  <p>30 mm<br/>23-138-30-07</p> |
|  |  |  <p>13 mm<br/>23-138-13-07</p>                           |  <p>38 mm<br/>23-138-38-07</p> |
|  |  |  <p>15 mm<br/>23-138-15-07</p>                           |  <p>38 mm<br/>23-138-38-07</p> |
|  |  |  <p>18 mm<br/>23-138-18-07</p>                           |  <p>44 mm<br/>23-138-44-07</p> |
|  |  |  <p>20 mm<br/>23-138-20-07</p>                           |  <p>50 mm<br/>23-138-50-07</p> |
|  <p><math>\frac{1}{2}</math><br/>Lambotte<br/>23-138-04-07 -<br/>23-138-06-07<br/>24 cm / 9 <math>\frac{4}{8}</math>"</p> |  <p><math>\frac{1}{2}</math><br/>Lambotte<br/>23-138-08-07 -<br/>23-138-50-07<br/>24 cm / 9 <math>\frac{4}{8}</math>"</p> |   |   |

# Osteotome

Osteotomes

Osteótomos

Ostéotomes

Osteotomi

1/4



**4 mm**

23-139-04-07



**20 mm**

23-139-20-07



**6 mm**

23-139-06-07



**25 mm**

23-139-25-07



**8 mm**

23-139-08-07



**30 mm**

23-139-30-07



**10 mm**

23-139-10-07



**38 mm**

23-139-38-07



**13 mm**

23-139-13-07



**44 mm**

23-139-44-07



**15 mm**

23-139-15-07



**18 mm**

23-139-18-07



**50 mm**

23-139-50-07

1/2



Lambotte  
23-139-04-07 -  
23-139-50-07  
24 cm / 9 4/8"



# Osteotome

Osteotomes  
Osteótomos  
Ostéotomes  
Osteotomi

# Knochenchirurgie

Bone Surgery  
Cirugía ósea  
Chirurgie osseuse  
Chirurgia ossea

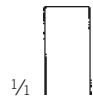
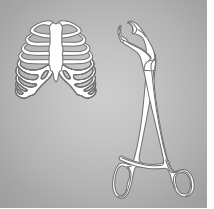

**6 mm**  
23-154-06-07



**9 mm**  
23-154-09-07



**13 mm**  
23-154-13-07



**16 mm**  
23-154-16-07



**19 mm**  
23-154-19-07



**25 mm**  
23-154-25-07

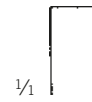

**6 mm**  
23-155-06-07



**9 mm**  
23-155-09-07



**13 mm**  
23-155-13-07



**16 mm**  
23-155-16-07



**19 mm**  
23-155-19-07



**25 mm**  
23-155-25-07



1/2

Smith-Petersen  
23-154-06-07 -  
23-154-25-07  
20,5 cm / 8 1/8"



1/2

Smith-Petersen  
23-155-06-07 -  
23-155-25-07  
20,5 cm / 8 1/8"

# Hohlmeißel, Osteotome

Gouges, Osteotomes

Gubias, Osteótomos

Gouges, Ostéotomes

Sgorbie, Osteotomi

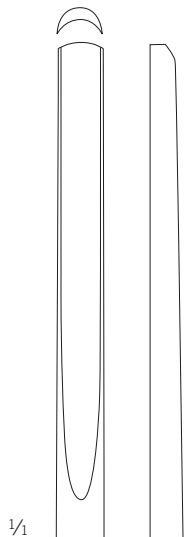

6 mm  
23-160-01-04

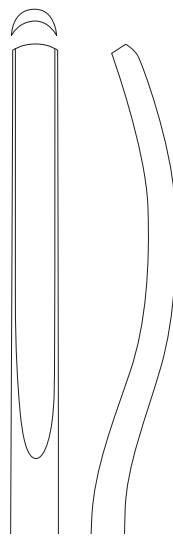

6 mm  
23-160-02-04

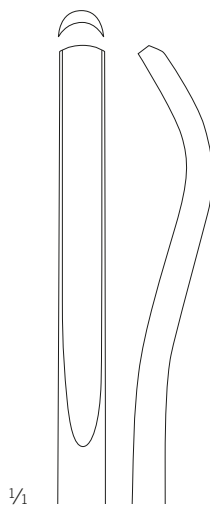

6 mm  
23-160-03-04

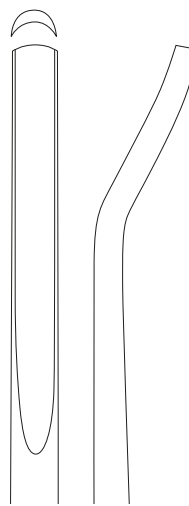

6 mm  
23-160-04-04



3 mm  
23-162-03-07



5 mm  
23-162-05-07



6 mm  
23-162-06-07



8 mm  
23-162-08-07



9 mm  
23-162-09-07



Hoke  
23-162-03-07 -  
23-162-09-07  
17 cm / 6 5/8"

Cobb  
23-160-01-04 -  
23-160-04-04  
28 cm / 11"



## Septummeißel, Septum-Hohlmeißel

Septum Chisels, Septum Gouges

Cinceles para tabique nasal, Gubias para tabique nasal

Élévateurs pour le périoste, Gouges pour la cloison nasale

Elevatori per il periosto, Sgorbie per il setto nasale

## Knochenchirurgie

Bone Surgery

Cirurgía ósea

Chirurgie osseuse

Chirurgia ossea

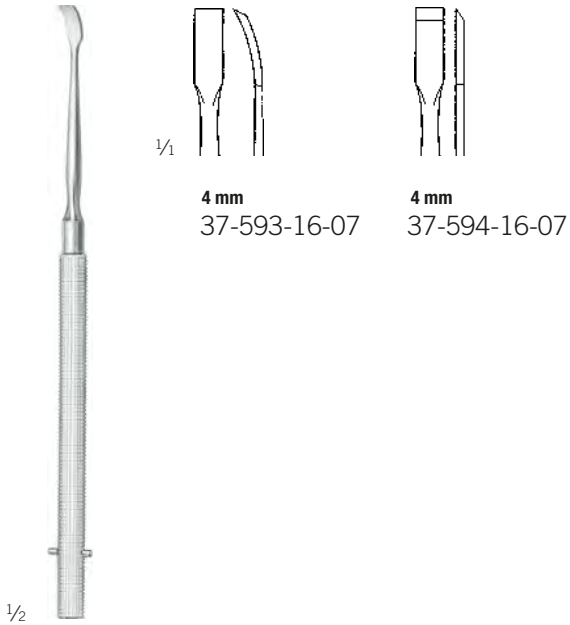
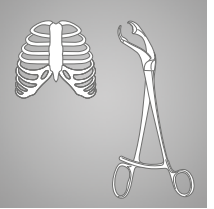

Freer  
37-593-16-07 -  
37-594-16-07  
16,5 cm / 6 5/8"

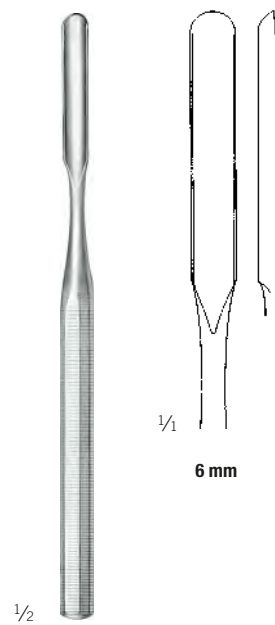

Freer  
37-595-15-07  
16 cm / 6 2/8"

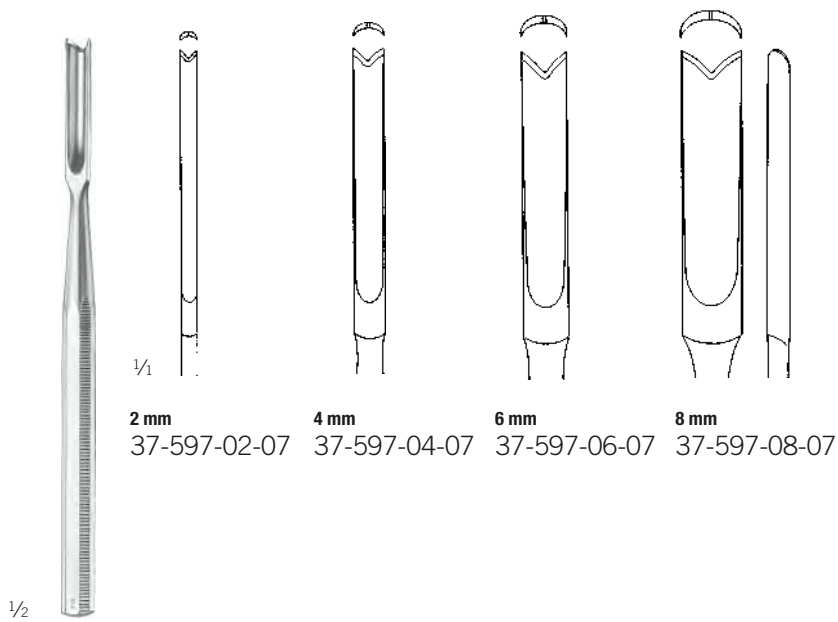

Ballenger  
37-597-02-07 -  
37-597-08-07  
15 cm / 5 7/8"

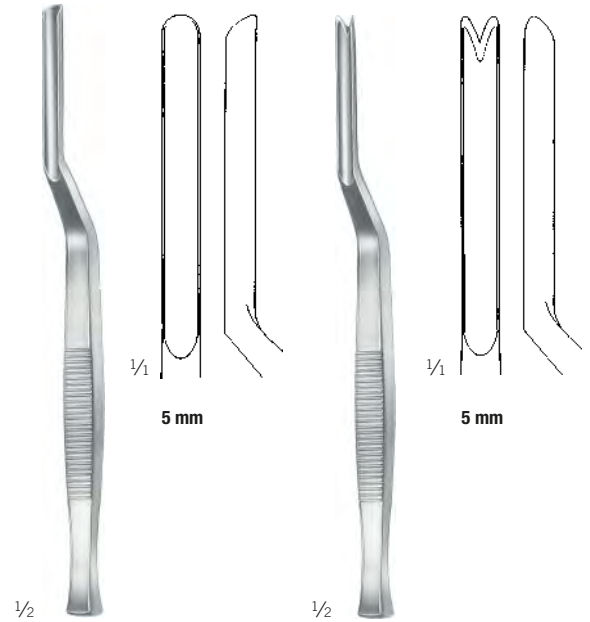

Killian  
37-601-16-07  
16 cm / 6 2/8"

Killian-Claus  
37-605-16-07  
16 cm / 6 2/8"

## Osteotome

Osteotomes

Osteótomos

Ostéotomes

Osteotomi

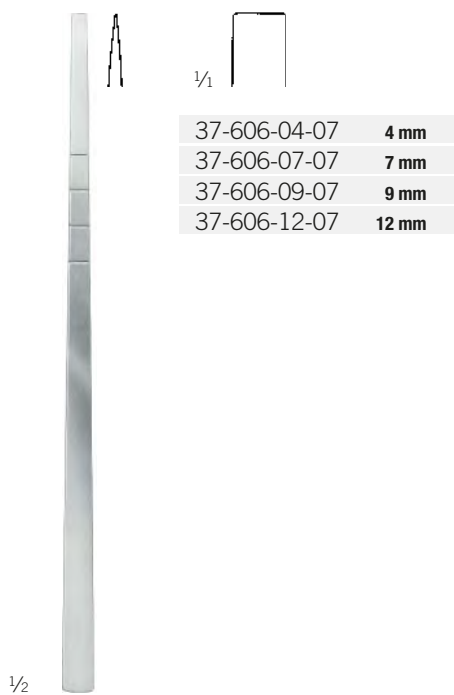

Cottle  
37-606-04-07 -  
37-606-12-07  
18,5 cm / 7 2/8"



Cottle  
37-607-06-07  
18,5 cm / 7 2/8"

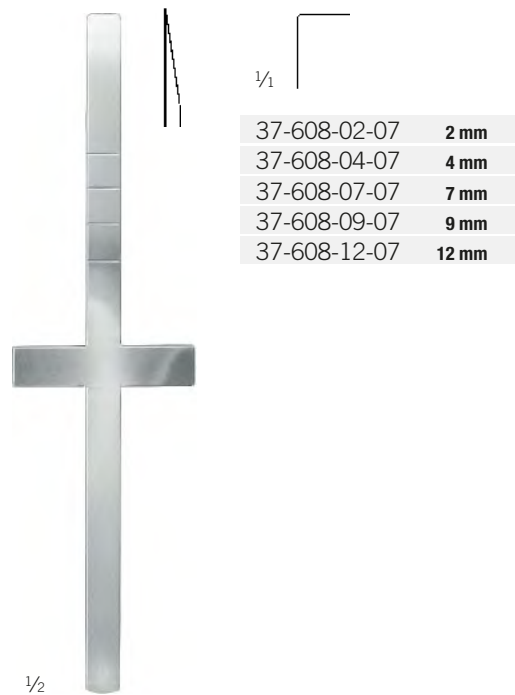

Cottle  
37-608-02-07 -  
37-608-12-07  
18,5 cm / 7 2/8"

## Osteotome

Osteotomes  
Osteótomos  
Ostéotomes  
Osteotomi

## Knochenchirurgie

Bone Surgery  
Cirugía ósea  
Chirurgie osseuse  
Chirurgia ossea

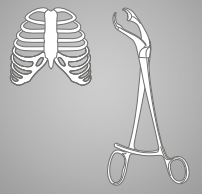

Cottle  
37-609-06-07  
18,5 cm / 7 2/8"

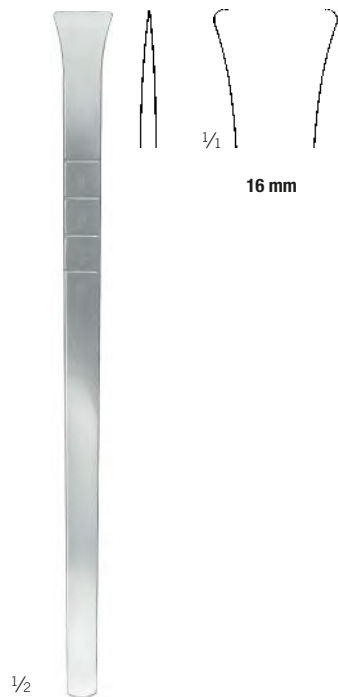

Cottle  
37-610-16-07  
18,5 cm / 7 2/8"

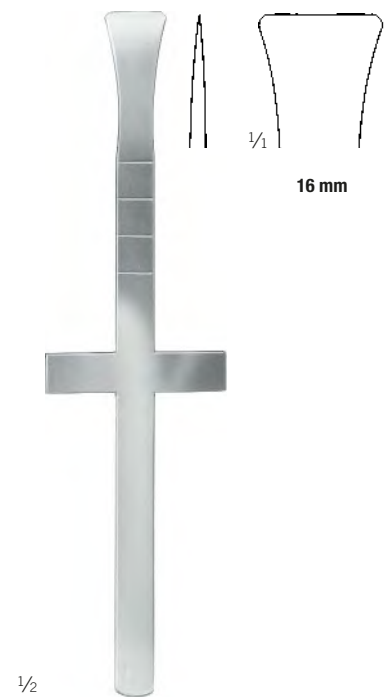

Cottle  
37-612-16-07  
18,5 cm / 7 2/8"

## Osteotome, Meißel

Osteotomes, Chisels  
 Osteótomos, Cinceles  
 Ostéotomes, Ciseaux-burins  
 Osteotomi, Scalpelli



1/1

|              |       |
|--------------|-------|
| 37-616-10-07 | 10 mm |
| 37-616-12-07 | 12 mm |
| 37-616-14-07 | 14 mm |

1/2

Rubin  
 37-616-10-07 -  
 37-616-14-07  
 18,5 cm / 7 2/8"



1/1

3 mm  
 37-620-03-07

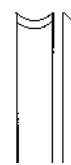

4,5 mm  
 37-620-04-07

1/2

Walter  
 37-620-03-07 -  
 37-620-04-07  
 19 cm / 7 4/8"



1/1

|              |       |
|--------------|-------|
| 37-622-03-07 | 3 mm  |
| 37-622-04-07 | 4 mm  |
| 37-622-07-07 | 7 mm  |
| 37-622-09-07 | 9 mm  |
| 37-622-12-07 | 12 mm |

1/2

Walter  
 37-622-03-07 -  
 37-622-12-07  
 19 cm / 7 4/8"



1/1

|              |      |
|--------------|------|
| 37-623-04-07 | 4 mm |
| 37-623-05-07 | 5 mm |
| 37-623-06-07 | 6 mm |
| 37-623-07-07 | 7 mm |

1/2

Fomon  
 37-623-04-07 -  
 37-623-07-07  
 16 cm / 6 2/8"

# Stößel

Tamper  
Punzón  
Pilon  
Pestone

# Knochenchirurgie

Bone Surgery  
Cirugía ósea  
Chirurgie osseuse  
Chirurgia ossea

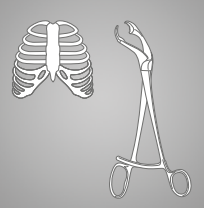

1/1 

23-197-03-04

Ø 3 mm



23-197-05-04

Ø 5 mm



23-197-08-04

Ø 8 mm



1/2

Caspar  
23-197-03-04 -  
23-197-08-04  
22 cm / 8 5/8"

Sic

1/1

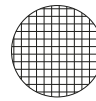

23-199-12-04

Ø 12 mm

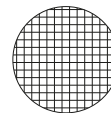

23-199-14-04

Ø 14 mm

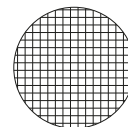

23-199-16-04

Ø 16 mm



1/2

23-199-12-04 -  
23-199-16-04  
20 cm / 8"

Sic

## Hämmer

Mallets  
Martillos  
Maillets  
Martelli

|              |                   |
|--------------|-------------------|
| Ø Kopf       | Kopfgewicht       |
| Ø Head       | Head weight       |
| Ø Cabeza     | Peso de la cabeza |
| Ø Tête       | Poids de tête     |
| Ø Testa      | Peso della testa  |
| <b>34 mm</b> | <b>460 g</b>      |

|              |                   |
|--------------|-------------------|
| Ø Kopf       | Kopfgewicht       |
| Ø Head       | Head weight       |
| Ø Cabeza     | Peso de la cabeza |
| Ø Tête       | Poids de tête     |
| Ø Testa      | Peso della testa  |
| <b>30 mm</b> | <b>200 g</b>      |



1/2

Cottle  
23-215-19-07

19 cm / 7 7/8"

plan/konvex  
plane / convex  
plano / convexo  
plan / convexe  
plano / convesso

Gesamtgewicht  
Total weight  
Peso total  
Poids total  
Peso totale

**300 g**



23-256-00-04

Ersatzbacke  
Spare facing  
Tapa de repuesto  
Placque de rechange  
Placche di ricambio



23-240-29-04,  
23-254-22-04



1/2

23-240-29-04

25 cm / 9 7/8"

plan (Kunststoff), konvex (Stahl),  
plane (nylon), convex (steel),  
plano (nilón), convexo (acero),  
plan (nylon), convexe (acier),  
plano (nilon), convesso (acciaio),



Gesamtgewicht  
Total weight  
Peso total  
Poids total  
Peso totale

**700 g**



## Hämmer

Mallets  
Martillos  
Maillets  
Martelli

## Knochenchirurgie

Bone Surgery  
Cirugía ósea  
Chirurgie osseuse  
Chirurgia ossea

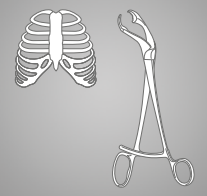

Ø Kopf  
Ø Head  
Ø Cabeza  
Ø Tête  
Ø Testa

Kopfgewicht  
Head weight  
Peso de la cabeza  
Poids de tête  
Peso della testa

**34 mm**     **270 g**



1/2



23-256-00-04

Ersatzbacke  
Spare facing  
Tapa de repuesto  
Plaque de rechange  
Placche di ricambio



23-240-29-04,  
23-254-22-04

Ø Kopf  
Ø Head  
Ø Cabeza  
Ø Tête  
Ø Testa

Kopfgewicht  
Head weight  
Peso de la cabeza  
Poids de tête  
Peso della testa

**25 mm**     **130 g**



1/2



23-262-90-98

Ersatzbacken (Paar)  
Spare facings (pair)  
Tapas de repuesto (par)  
Plaques de rechange (paire)  
Placche di ricambio (paio)



23-262-19-04

23-254-22-04

25 cm / 9 7/8"



Gesamtgewicht  
Total weight  
Peso total  
Poids total  
Peso totale

**510 g**

23-262-19-04

19 cm / 7 1/8"



Gesamtgewicht  
Total weight  
Peso total  
Poids total  
Peso totale

**260 g**

## Scharfe Löffel

Bone Curettes

Cucharillas cortantes

Curettes tranchantes

Curette taglienti

1/1 ○

2,5 mm  
Fig. 0000

23-280-40-04

○

3,0 mm  
Fig. 000

23-280-30-04

1/1 ○

4,5 mm  
Fig. 0

23-282-10-04

○

5,5 mm  
Fig. 1

23-282-01-04

○

3,5 mm  
Fig. 00

23-280-20-04

○

4,5 mm  
Fig. 0

23-280-10-04

○

6,0 mm  
Fig. 2

23-282-02-04

○

7 mm  
Fig. 3

23-282-03-04

○

5,5 mm  
Fig. 1

23-280-01-04

○

6,0 mm  
Fig. 2

23-280-02-04

○

8,5 mm  
Fig. 4

23-282-04-04

○

7,0 mm  
Fig. 3

23-280-03-04

○

8,5 mm  
Fig. 4

23-280-04-04

○

9,5 mm  
Fig. 5

23-280-05-04

○

11,5 mm  
Fig. 6

23-280-06-04



1/2

Volkman  
23-282-01-04 -  
23-282-10-04

27 cm / 10 5/8"

oval  
oval  
ovalada  
ovale  
ovala



1/2

Volkman  
23-280-01-04 -  
23-280-40-04

17 cm / 6 5/8"

oval  
oval  
ovalada  
ovale  
ovala

## Scharfe Löffel

Bone Curettes  
Cucharillas cortantes  
Curettes tranchantes  
Curette taglienti

## Knochenchirurgie

Bone Surgery  
Cirugía ósea  
Chirurgie osseuse  
Chirurgia ossea

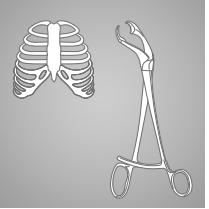

1/4



**3,0 mm**  
**Fig. 0000**  
23-304-40-07



**3,7 mm**  
**Fig. 000**  
23-304-30-07

1/4



**2,8 mm**  
**Fig. 0000**  
23-306-40-07



**4,5 mm**  
**Fig. 00**  
23-304-20-07



**5,2 mm**  
**Fig. 0**  
23-304-10-07



**3,6 mm**  
**Fig. 000**  
23-306-30-07



**6,8 mm**  
**Fig. 1**  
23-305-01-07



**8,5 mm**  
**Fig. 2**  
23-305-02-07



**4,4 mm**  
**Fig. 00**  
23-306-20-07



**10,0 mm**  
**Fig. 3**  
23-305-03-07



**11,5 mm**  
**Fig. 4**  
23-305-04-07



**5,2 mm**  
**Fig. 0**  
23-306-10-07



**13,0 mm**  
**Fig. 5**  
23-305-05-07



**14,5 mm**  
**Fig. 6**  
23-305-06-07



1/2

**Volkmann**  
23-304-10-07 - 23-305-06-07  
17 cm / 6 5/8"  
oval, mit Hohlheft  
oval, with hollow handle  
ovalada, con mango hueco  
ovale, avec manche creux  
ovale, con manico vuoto



1/2

**Daubenspeck**  
23-306-10-07 - 23-306-40-07  
17 cm / 6 5/8"  
oval, mit Hohlheft  
oval, with hollow handle  
ovalada, con mango hueco  
ovale, avec manche creux  
ovale, con manico vuoto

## Scharfe Löffel

Bone Curettes

Cucharillas cortantes

Curettes tranchantes

Curette taglienti



4,8 mm  
23-336-25-07



3,5 mm  
Fig. 3  
23-340-03-07



4,8 mm  
23-337-25-07



4,0 mm  
Fig. 4  
23-340-04-07



1/2

Scoville  
23-336-25-07 -  
23-339-25-07

25 cm / 9 7/8"

oval, mit Hohlheft  
oval, with hollow handle  
ovalada, con mango hueco  
ovale, avec manche creux  
ovala, con manico vuoto



4,8 mm  
23-339-25-07



4,5 mm  
Fig. 5  
23-340-05-07



1/2

Simon  
23-340-03-07 - 23-340-06-07

22,5 cm / 8 7/8"

oval, mit Hohlheft  
oval, with hollow handle  
ovalada, con mango hueco  
ovale, avec manche creux  
ovale, con manico vuoto



5,5 mm  
Fig. 6  
23-340-06-07

## Scharfe Löffel

Bone Curettes  
Cucharillas cortantes  
Curettes tranchantes  
Curette taglienti

## Knochenchirurgie

Bone Surgery  
Cirugía ósea  
Chirurgie osseuse  
Chirurgia ossea

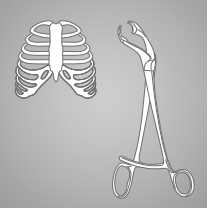

6,0 mm

Fig. 1

23-342-01-07

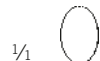

4,8 mm

Fig. 1

23-350-01-07



2,7 mm

Fig. 1

36-743-10-07



5,0 mm

Fig. 0

23-342-10-07



5,8 mm

Fig. 2

23-350-02-07



2,5 mm

Fig. 2

36-743-20-07



4,5 mm

Fig. 00

23-342-20-07



6,8 mm

Fig. 3

23-350-03-07



2,2 mm

Fig. 3

36-743-30-07



3,5 mm

Fig. 000

23-342-30-07



2,0 mm

Fig. 4

36-743-40-07



1,5 mm

Fig. 5

36-743-50-07

1/2



23-342-01-07 - 23-342-30-07

25 cm / 9 7/8"  
oval, mit Hohlheft  
oval, with hollow handle  
ovalada, con mango hueco  
ovale, avec manche creux  
ovale, con manico vuoto

1/2



Halle  
23-350-01-07 - 23-350-03-07

21 cm / 8 2/8"  
oval, biegsamer Schaft, mit Hohlheft  
oval, malleable shaft, with hollow handle  
ovalada, vástago maleable, con mango hueco  
ovale, tige malléable, avec manche creux  
ovale, gambo malleabile, con manico vuoto

1/2



Lempert  
36-743-10-07 - 36-743-50-07

21,5 cm / 8 4/8"  
scharf  
sharp  
agudo  
pointu  
acuto

## Scharfe Doppellöffel

Bone Curettes, double-ended

Cucharillas de doble extremo

Curettes doubles

Curette doppia

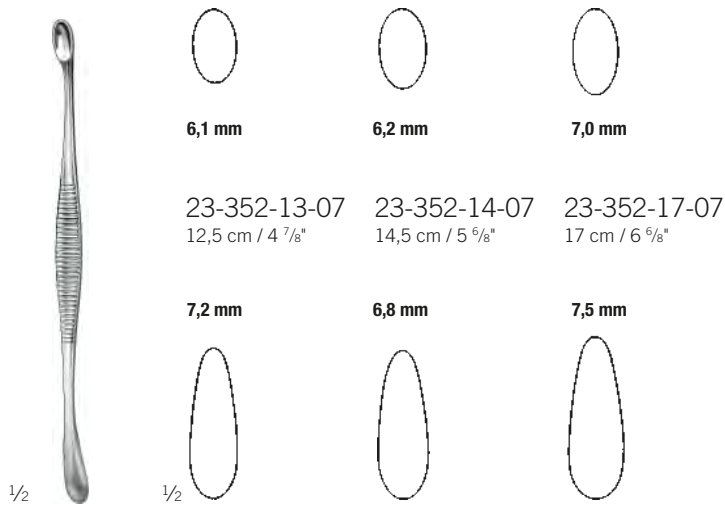

6,1 mm

6,2 mm

7,0 mm

23-352-13-07  
12,5 cm / 4 7/8"

23-352-14-07  
14,5 cm / 5 5/8"

23-352-17-07  
17 cm / 6 5/8"

7,2 mm

6,8 mm

7,5 mm

Volkman  
23-352-13-07 - 23-352-17-07



Ø 6,5 mm

6,0 mm

23-356-21-07  
21 cm / 8 2/8"

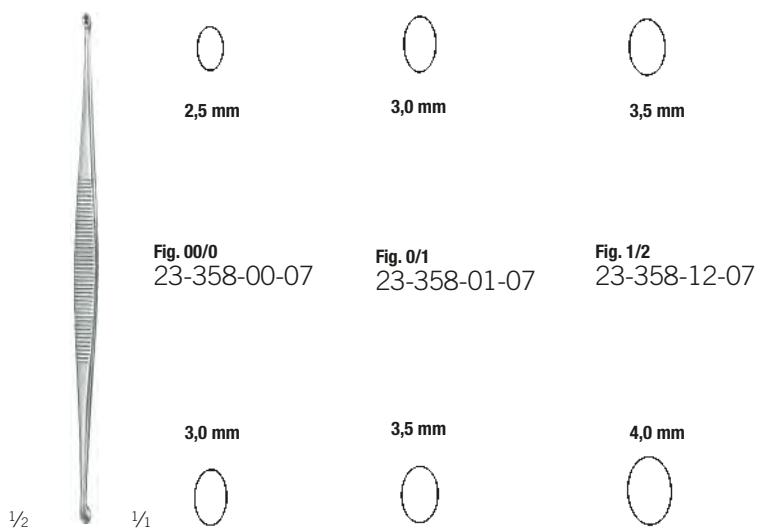

2,5 mm

3,0 mm

3,5 mm

Fig. 00/0  
23-358-00-07

Fig. 0/1  
23-358-01-07

Fig. 1/2  
23-358-12-07

3,0 mm

3,5 mm

4,0 mm

Williger  
23-358-00-07 -  
23-358-12-07

14 cm / 5 4/8"

oval  
oval  
ovalada  
ovale  
ovala

**Scharfe Doppellöffel**  
 Bone Currettes, double-ended  
 Cucharillas de doble extremo  
 Curettes doubles  
 Curette doppie

**Knochenchirurgie**  
 Bone Surgery  
 Cirugía ósea  
 Chirurgie osseuse  
 Chirurgia ossea

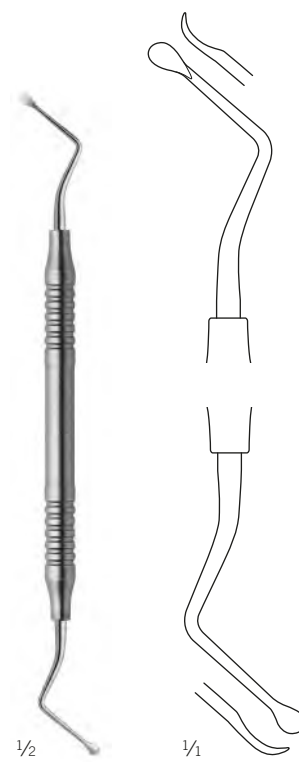
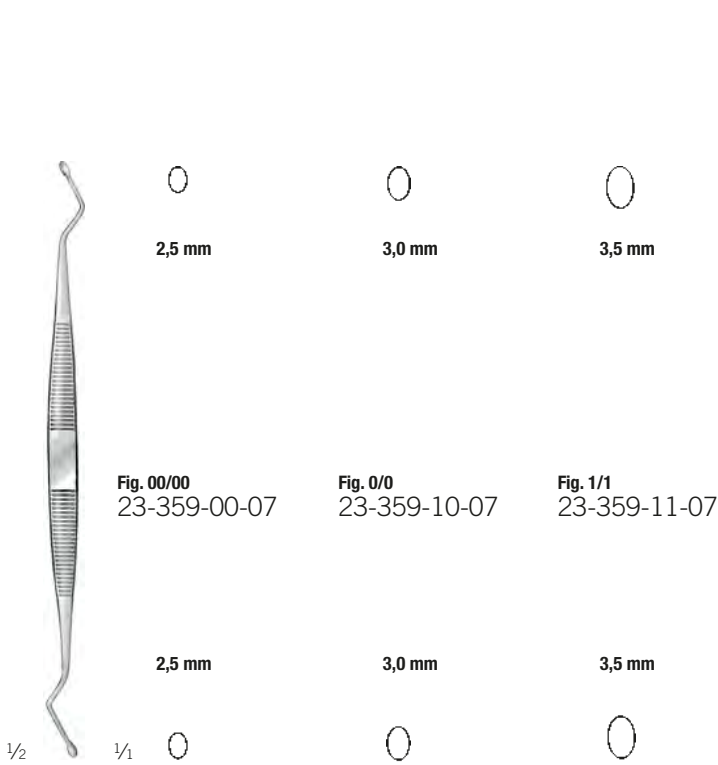
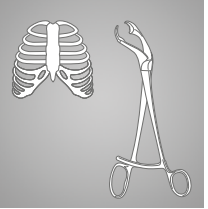

Williger  
 23-359-00-07 -  
 23-359-11-07  
 16,5 cm / 6 7/8"  
 oval  
 oval  
 ovalada  
 ovale  
 ovale

Lucas-Martin  
 23-362-11-07  
 17,5 cm / 6 7/8"  
**Fig. 1/1**

## Löffel für die zervikale Mikrodisektomie





Curettes for cervical Microdissectomy

Cucharillas para la microdissectomía cervical

Curettes pour la microdissectomie cervicale

Curette per microdissectomia cervicale

### Löffel, zervikal Curette, cervical Cucharilla, cervical Curette, cervicale Curetta, cervicale

|   |  |   | ¼                     | 0            | 0            | 0            | 0            |
|---|--|---|-----------------------|--------------|--------------|--------------|--------------|
|   |  |   | Fig. 1                | Fig. 2       | Fig. 3       | Fig. 4       | Fig. 4       |
| ¼ |   | vorwärts gewinkelt / gerade<br>angled forward / straight                                  | <b>21,5 cm / 8 ½"</b> | 23-997-01-07 | 23-997-02-07 | 23-997-03-07 | 23-997-04-07 |
|   |  | acodada adelante / recta<br>angulée vers l'avant / droite<br>angolata in avanti / diritta | <b>24 cm / 9 ½"</b>   | 23-997-40-07 | 23-997-41-07 | 23-997-42-07 | 23-997-43-07 |
| ¼ |   | vorwärts gewinkelt / gebogen<br>angled forward / curved                                   | <b>21,5 cm / 8 ½"</b> | 23-997-10-07 | 23-997-11-07 | 23-997-12-07 | 23-997-13-07 |
|   |  | acodada adelante / curvada<br>angulée vers l'avant / coudée<br>angolata in avanti / curva | <b>24 cm / 9 ½"</b>   | 23-997-50-07 | 23-997-51-07 | 23-997-52-07 | 23-997-53-07 |
| ¼ |   | rückwärts gewinkelt / gerade<br>angled backward / straight                                | <b>21,5 cm / 8 ½"</b> | 23-997-20-07 | 23-997-21-07 | 23-997-22-07 | 23-997-23-07 |
|   |  | acodada atrás / recta<br>angulée vers l'arrière / droite<br>angolata indietro / diritta   | <b>24 cm / 9 ½"</b>   | 23-997-60-07 | 23-997-61-07 | 23-997-62-07 | 23-997-63-07 |
| ¼ |  | rückwärts gewinkelt / gebogen<br>angled backward / curved                                 | <b>21,5 cm / 8 ½"</b> | 23-997-30-07 | 23-997-31-07 | 23-997-32-07 | 23-997-33-07 |
|   |  | acodada atrás / curvada<br>angulée vers l'arrière / coudée<br>angolata indietro / curva   | <b>24 cm / 9 ½"</b>   | 23-997-70-07 | 23-997-71-07 | 23-997-72-07 | 23-997-73-07 |



½

23-997-01-07 -  
23-997-73-07



## Löffel für die lumbale Mikrodiskektomie

Curettes for lumbar Microdiscectomy  
Cucharillas para la microdissectomía lumbar  
Curettes pour la microdissectomie lumbaire  
Curette per microdissectomia lumbare

## Knochenchirurgie

Bone Surgery  
Cirugía ósea  
Chirurgie osseuse  
Chirurgia ossea

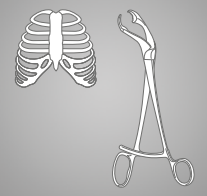

1/2

23-998-01-07 -  
23-998-52-07

### Löffel, lumbal Curette, lumbar Cucharilla, lumbar Curette, lumbaire Curetta, lombare

|     |  | 1/1            |              |              |              |
|-----|--|----------------|--------------|--------------|--------------|
|     |  | Fig. 0         | Fig. 1       | Fig. 2       |              |
| 1/1 | vorwärts gewinkelt / gerade<br>angled forward / straight<br>acodada adelante / recta<br>angulée vers l'avant / droite<br>angolata in avanti / diritta  | 24 cm / 9 1/8" | 23-998-01-07 | 23-998-02-07 | 23-998-03-07 |
| 1/1 | vorwärts gewinkelt / gebogen<br>angled forward / curved<br>acodada adelante / curvada<br>angulée vers l'avant / coudée<br>angolata in avanti / curva   | 24 cm / 9 1/8" | 23-998-10-07 | 23-998-11-07 | 23-998-12-07 |
| 1/1 | vorwärts gewinkelt / abwärts gebogen<br>angled forward / curved downward<br>acodada adelante / curvada abajo<br>angulée vers l'avant / coudée vers le bas<br>angolata in avanti / curva verso il basso | 24 cm / 9 1/8" | 23-998-20-07 | 23-998-21-07 | 23-998-22-07 |
| 1/1 | rückwärts gewinkelt / gerade<br>angled backward / straight<br>acodada atrás / recta<br>angulée vers l'arrière / droite<br>angolata indietro / diritta  | 24 cm / 9 1/8" | 23-998-30-07 | 23-998-31-07 | 23-998-32-07 |
| 1/1 | rückwärts gewinkelt / gebogen<br>angled backward / curved<br>acodada atrás / curvada<br>angulée vers l'arrière / coudée<br>angolata indietro / curva   | 24 cm / 9 1/8" | 23-998-40-07 | 23-998-41-07 | 23-998-42-07 |
| 1/1 | rückwärts gewinkelt / abwärts gebogen<br>angled backward / curved downward<br>acodada atrás / curvada abajo<br>angulée vers l'arrière / coudée vers le bas<br>angolata indietro / curva verso il basso | 24 cm / 9 1/8" | 23-998-50-07 | 23-998-51-07 | 23-998-52-07 |

## Raspatorien

Periosteal Elevators

Periostótomos

Rugines-raspatoires

Periostotomi

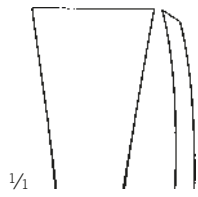

**16 mm**  
23-400-01-07  
19 cm / 7 4/8"

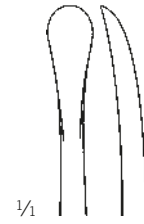

**7 mm**  
23-400-10-07  
16 cm / 6 2/8"

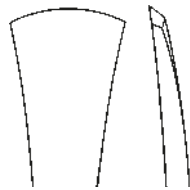

**16 mm**  
23-400-02-07  
20 cm / 7 7/8"

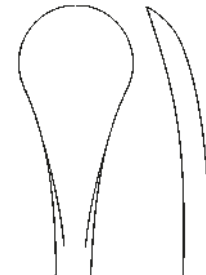

**15 mm**  
23-400-11-07  
18,5 cm / 7 2/8"



**12 mm**  
23-400-03-07  
19 cm / 7 4/8"

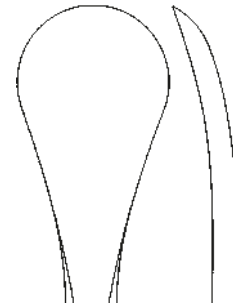

**20 mm**  
23-400-12-07  
19 cm / 7 4/8"



1/2

Martin-Langenbeck  
23-400-01-07 -  
23-400-04-07

massiv  
solid  
macizo  
solide  
pieno



1/2

Martin-Hoen  
23-400-10-07 -  
23-400-12-07

massiv  
solid  
macizo  
solide  
pieno

## Raspatorien

Periosteal Elevators  
Periostótomos  
Rugines-raspatoires  
Periostotomi

## Knochenchirurgie

Bone Surgery  
Cirugía ósea  
Chirurgie osseuse  
Chirurgia ossea

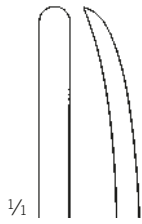
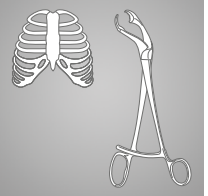

4 mm  
23-400-20-07  
17,5 cm / 7"



6 mm  
23-400-21-07  
17,5 cm / 7"



5 mm  
23-400-25-07  
19,5 cm / 7 6/8"



7 mm  
23-400-26-07  
19,5 cm / 7 6/8"

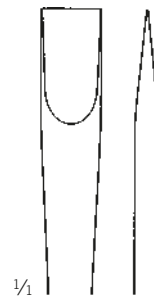

8 mm



1/2

Martin-Cushing  
23-400-20-07 -  
23-400-26-07

massiv  
solid  
macizo  
solide  
pieno



1/2

Martin-Cushing  
23-400-30-07

17 cm / 6 6/8"

massiv  
solid  
macizo  
solide  
pieno

## Raspatorien

Periosteal Elevators  
Periostótomos  
Rugines-raspatoires  
Periostotomi

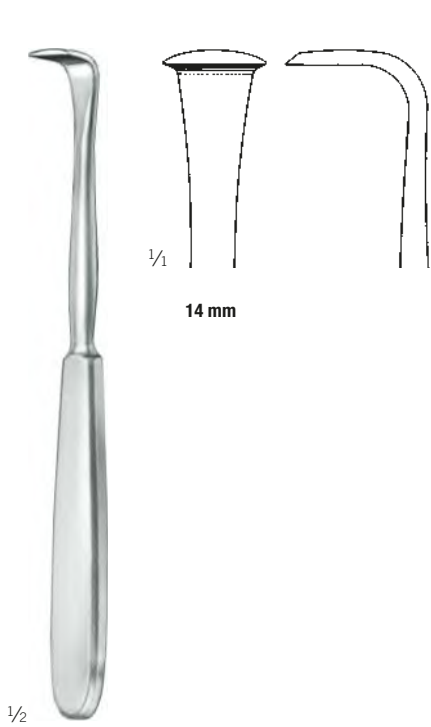

Langenbeck  
23-401-18-07  
18 cm / 7 1/8"  
mit Hohlheft  
with hollow handle  
con mango hueco  
avec manche creux  
con manico vuoto

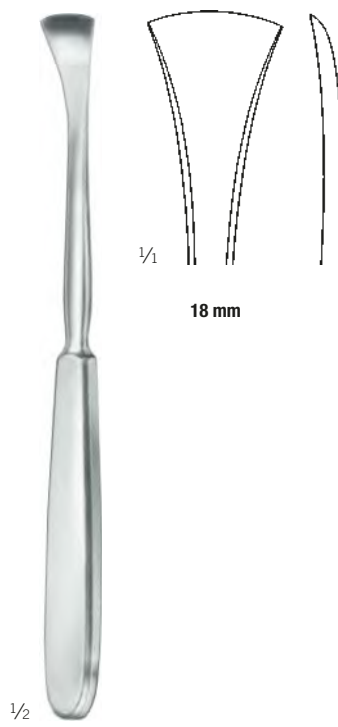

Langenbeck  
23-402-19-07  
19 cm / 7 4/8"  
mit Hohlheft  
with hollow handle  
con mango hueco  
avec manche creux  
con manico vuoto

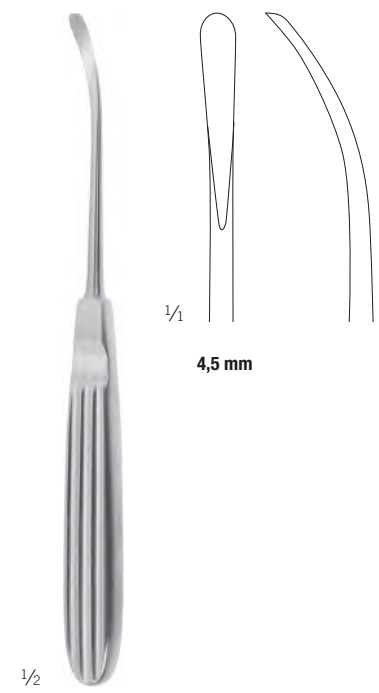

Landolt  
23-404-18-07  
17,5 cm / 6 7/8"

## Raspatorien

Periosteal Elevators  
Periostótomos  
Rugines-raspatoires  
Periostotomi

## Knochenchirurgie

Bone Surgery  
Cirugía ósea  
Chirurgie osseuse  
Chirurgia ossea

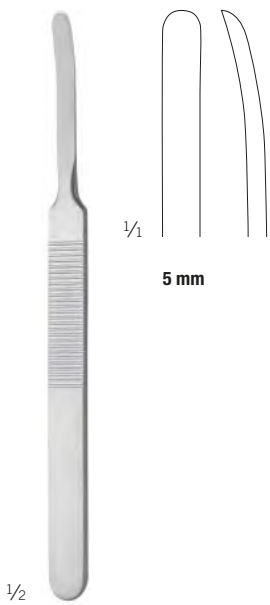
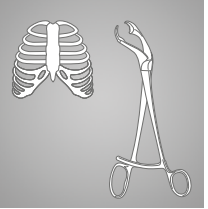

König  
23-406-16-07  
15,5 cm / 6 1/8"

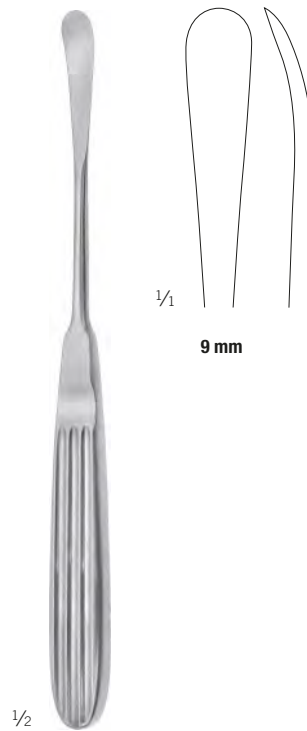

Cottle  
23-412-20-07  
19,5 cm / 7 5/8"

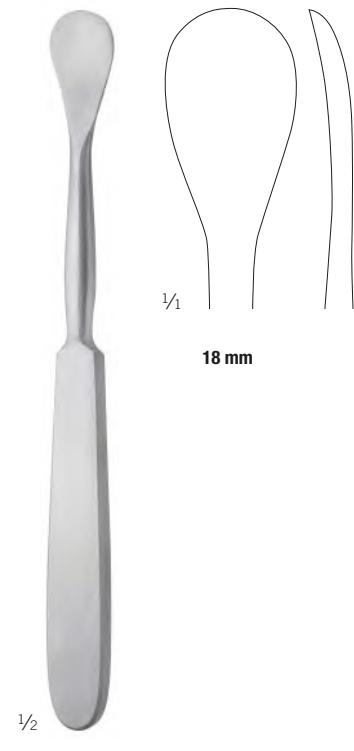

Sedillot  
23-414-19-07  
18,5 cm / 7 2/8"

## Raspatorien

Periosteal Elevators  
 Periostótomos  
 Rugines-raspatoires  
 Periostotomi

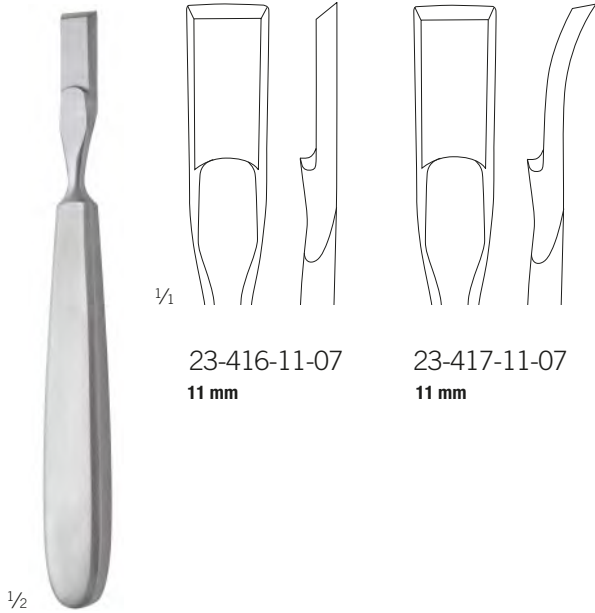

1/4

23-416-11-07  
 11 mm

23-417-11-07  
 11 mm

1/2

Farabeuf-Collin  
 23-416-11-07 - 23-417-11-07  
 15,5 cm / 6 1/8"

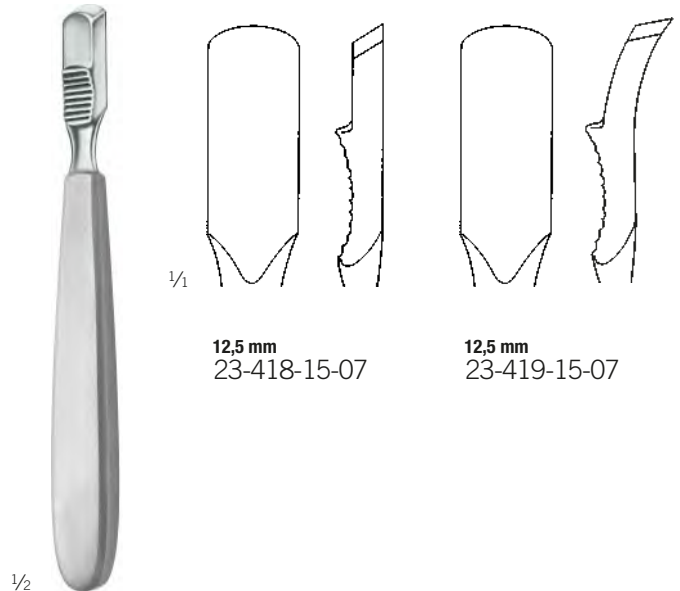

1/4

12,5 mm  
 23-418-15-07

12,5 mm  
 23-419-15-07

1/2

Farabeuf  
 23-418-15-07 -  
 23-419-15-07  
 15,5 cm / 6 1/8"  
 mit Hohlheft  
 with hollow handle  
 con mango hueco  
 avec manche creux  
 con manico vuoto



1/4

3 mm  
 23-423-06-07  
 18 cm / 7 1/8"

6,5 mm  
 23-423-01-07  
 18 cm / 7 1/8"

9,5 mm  
 23-423-02-07  
 19 cm / 7 4/8"

12,5 mm  
 23-423-03-07  
 19 cm / 7 4/8"

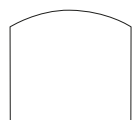

16 mm  
 23-423-07-07  
 20 cm / 7 7/8"

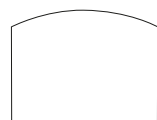

19 mm  
 23-423-04-07  
 20 cm / 7 7/8"

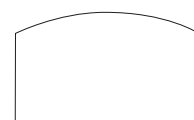

25,5 mm  
 23-423-05-07  
 21,5 cm / 8 4/8"

1/2

Key  
 23-423-01-07 -  
 23-423-07-07

## Raspatorien

Periosteal Elevators  
Periostótomos  
Rugines-raspatoires  
Periostotomi

## Knochenchirurgie

Bone Surgery  
Cirugía ósea  
Chirurgie osseuse  
Chirurgia ossea

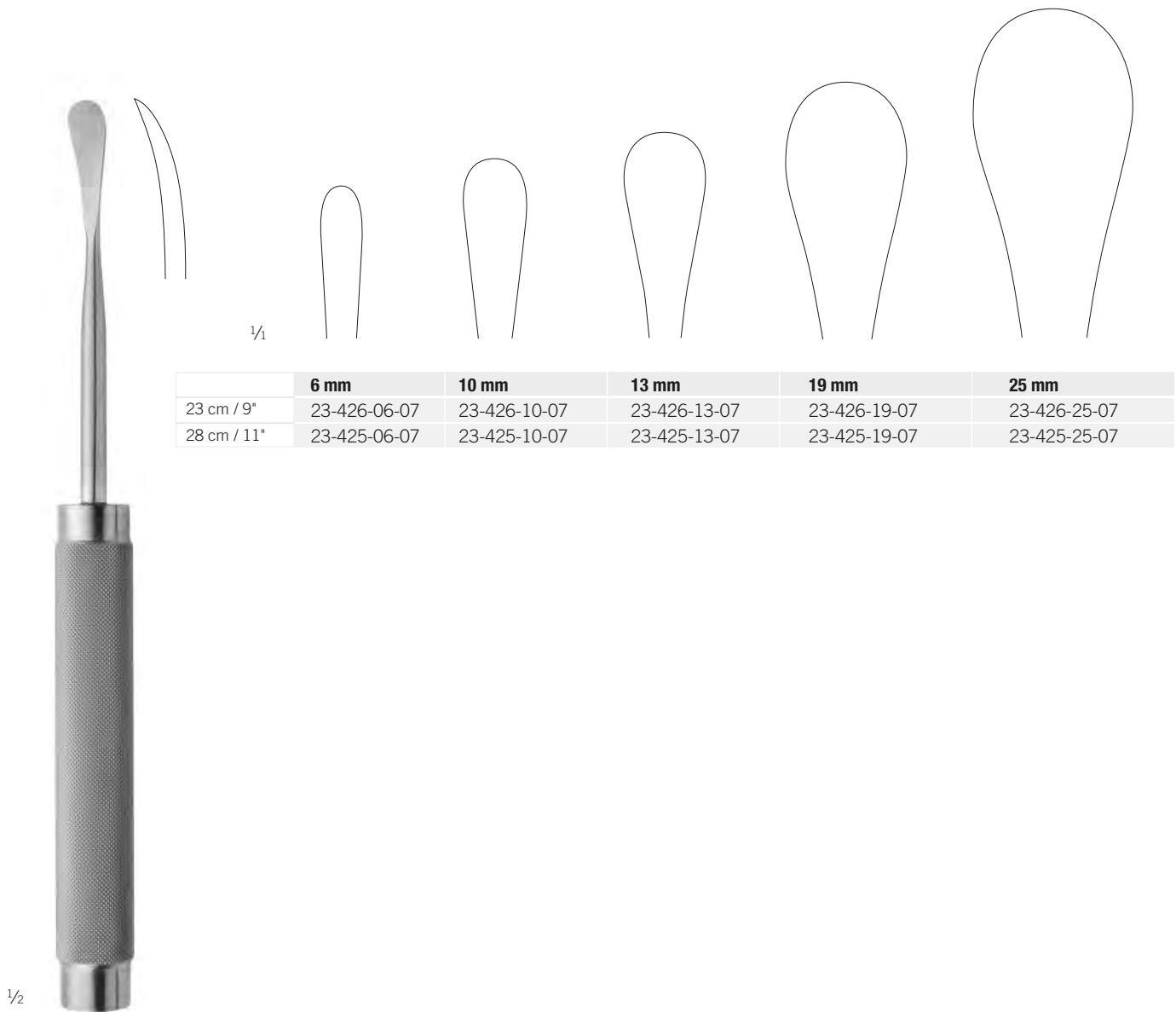
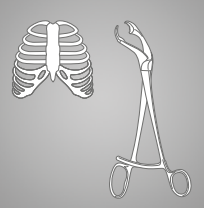

|             | <b>6 mm</b>  | <b>10 mm</b> | <b>13 mm</b> | <b>19 mm</b> | <b>25 mm</b> |
|-------------|--------------|--------------|--------------|--------------|--------------|
| 23 cm / 9"  | 23-426-06-07 | 23-426-10-07 | 23-426-13-07 | 23-426-19-07 | 23-426-25-07 |
| 28 cm / 11" | 23-425-06-07 | 23-425-10-07 | 23-425-13-07 | 23-425-19-07 | 23-425-25-07 |

Cobb  
23-425-06-07 -  
23-426-25-07

## Raspatorien

Periosteal Elevators

Periostótomos

Rugines-raspatoires

Periostotomi

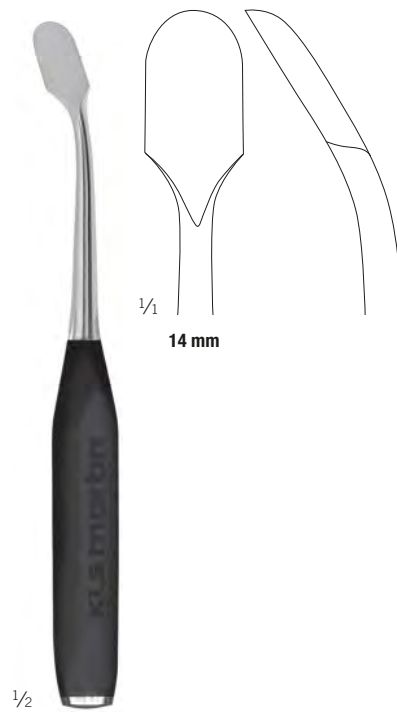



## Raspatorien

Periosteal Elevators  
Periostótomos  
Rugines-raspatoires  
Periostotomi

## Knochenchirurgie

Bone Surgery  
Cirugía ósea  
Chirurgie osseuse  
Chirurgia ossea

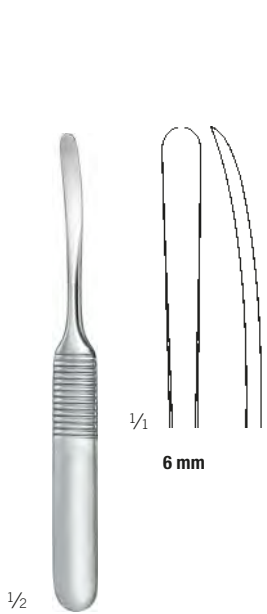
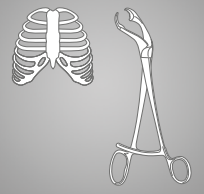

Williger  
23-434-13-07  
12,5 cm / 4 7/8"  
massiv  
solid  
macizo  
solide  
pieno

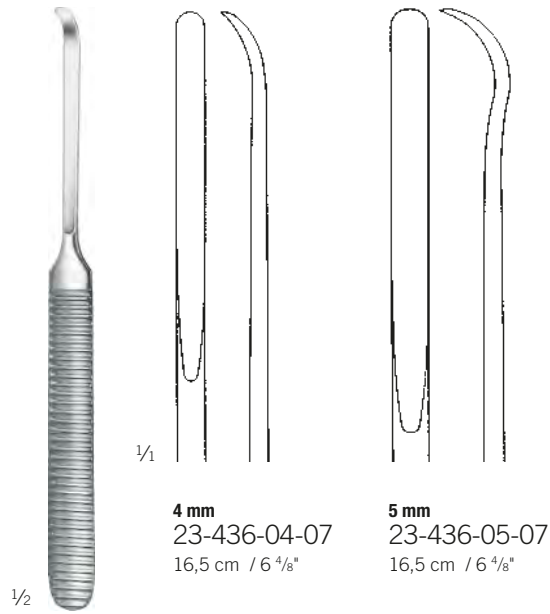

Kahre-Williger  
23-436-04-07 -  
23-436-05-07  
16,5 cm / 6 4/8"  
massiv  
solid  
macizo  
solide  
pieno

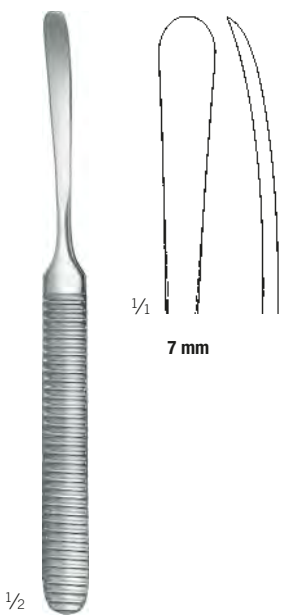

Williger  
23-436-07-07  
16 cm / 6 4/8"  
massiv  
solid  
macizo  
solide  
pieno

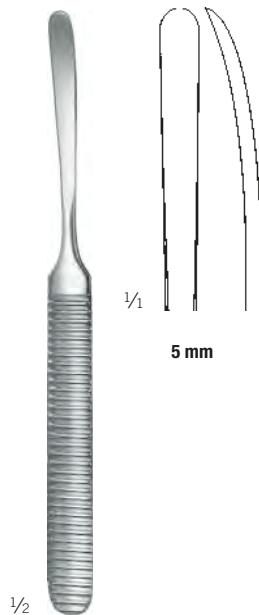

Williger  
23-436-16-07  
16 cm / 6 4/8"  
massiv  
solid  
macizo  
solide  
pieno

## Raspatorien

Periosteal Elevators  
 Periostótomos  
 Rugines-raspatoires  
 Periostotomi

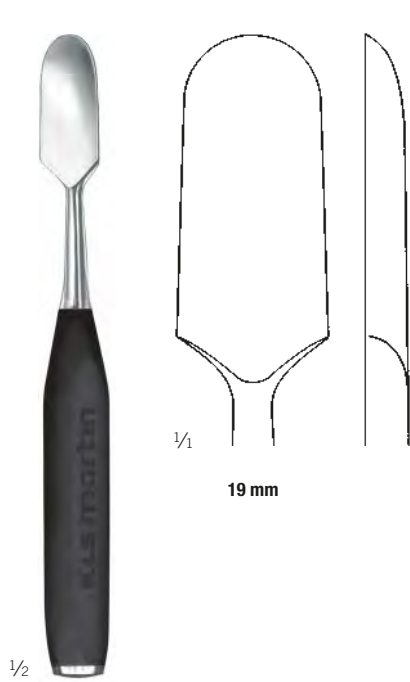

1/2

19 mm

1/2

23-437-20-04

20 cm / 7 7/8"

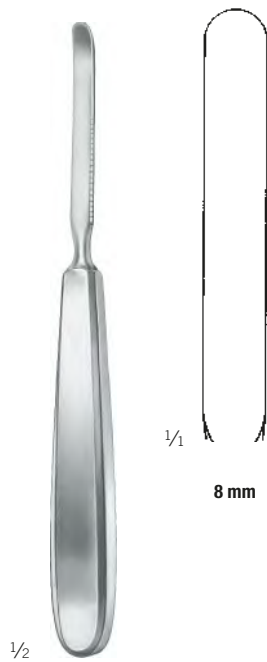

1/2

8 mm

1/2

23-439-08-07

17 cm / 6 5/8"

mit Hohlheft  
 with hollow handle  
 con mango hueco  
 avec manche creux  
 con manico vuoto



1/2

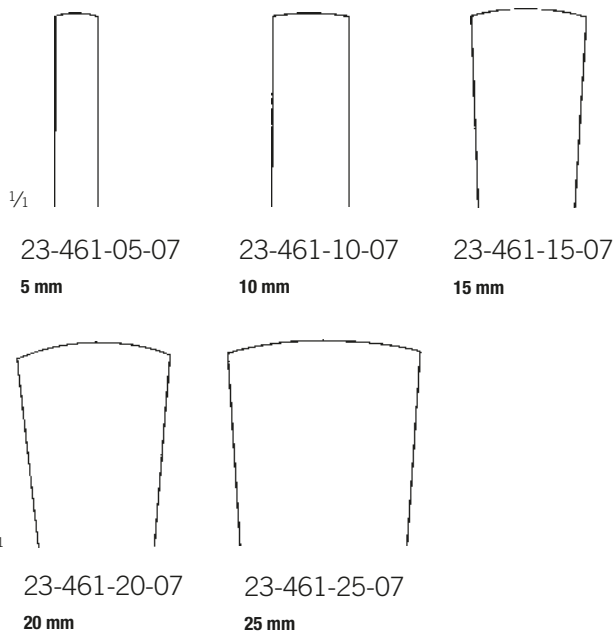

1/2

23-461-05-07

5 mm

23-461-10-07

10 mm

23-461-15-07

15 mm

1/2

23-461-20-07

20 mm

23-461-25-07

25 mm

Lambotte

23-461-05-07 - 23-461-25-07

21,5 cm / 8 1/2"

## Raspatorien

Periosteal Elevators  
Periostótomos  
Rugines-raspatoires  
Periostotomi

## Knochenchirurgie

Bone Surgery  
Cirugía ósea  
Chirurgie osseuse  
Chirurgia ossea

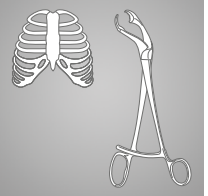

1/2

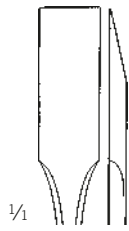

1/1

**7,9 mm**  
23-484-17-07  
17 cm / 6 5/8"



**5,0 mm**  
23-485-17-07  
17,5 cm / 6 7/8"



**7,7 mm**  
23-486-17-07  
17,5 cm / 6 7/8"

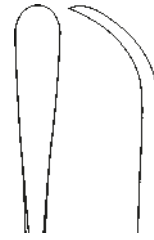

**6,3 mm**  
23-487-17-07  
17 cm / 6 5/8"

Adson  
23-484-17-07 - 23-487-17-07



1/2

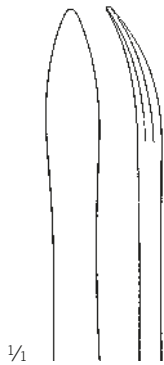

1/1

**7 mm**  
23-495-20-07  
19,5 cm / 7 5/8"

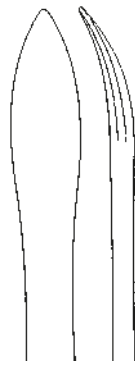

**10 mm**  
23-497-20-07  
19,5 cm / 7 5/8"

Langenbeck  
23-495-20-07 - 23-497-20-07

## Glbellaraspeln, Nasenraspeln

Glabella Rasps, Nasal Rasps

Escofinas para glabella, Escofinas nasales

Râpes pour la glabelle, Râpes nasales

Raspe per glabella, Raspe nasali



1/2

Aufricht

37-671-21-07 -  
37-673-21-07

21 cm / 8 2/8"

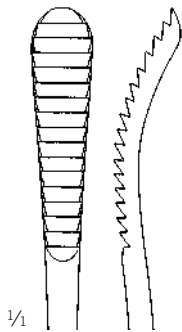

1/1

**32 x 9 mm**

37-671-21-07

auf Stoss schneidend  
pushing cut  
cortante a empuje  
tranchante à impact  
tagliente a urto

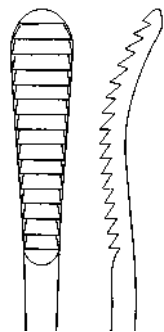

**32 x 9 mm**

37-673-21-07

auf Zug schneidend  
drawing cut  
cortante a tracción  
tranchante à traction  
tagliente a trazione



1/2

Lewis

37-674-18-07 -  
37-676-18-07

19 cm / 7 4/8"

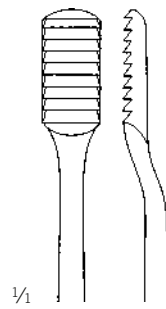

1/1

**15 x 8 mm**

37-674-18-07

auf Zug schneidend  
drawing cut  
cortante a tracción  
tranchante à traction  
tagliente a trazione

feine Zahnung  
delicate serration  
dentado fina  
denture fine  
dentatura delicata

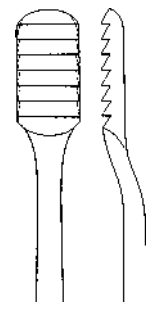

**15 x 8 mm**

37-676-18-07

auf Zug schneidend  
drawing cut  
cortante a tracción  
tranchante à traction  
tagliente a trazione

grobe Zahnung  
coarse serration  
dentado grueso  
denture grossière  
dentatura grossolana



1/2

**7,0 mm**

Fomon

37-680-21-07

20,5 cm / 8 1/8"

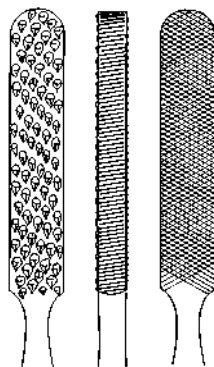

1/1

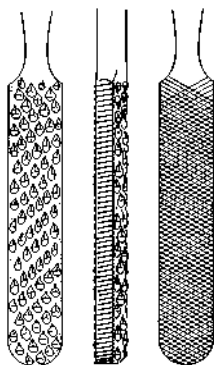

# Nasenraspeln

Nasal Rasps  
Escofinas nasales  
Râpes nasales  
Raspe nasali

# Knochenchirurgie

Bone Surgery  
Cirugía ósea  
Chirurgie osseuse  
Chirurgia ossea

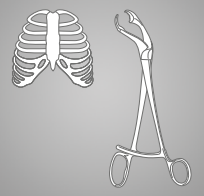

## TC GOLD

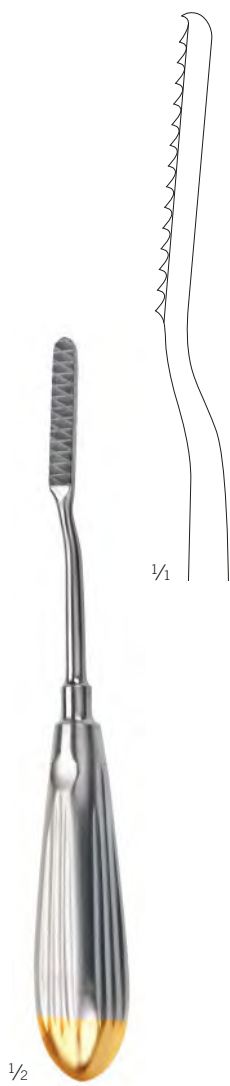

Fig. 1  
37-680-01-07



Fig. 2  
37-680-02-07



Fig. 3  
37-680-03-07

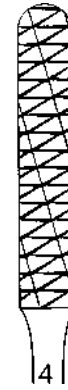

Fig. 4  
37-680-04-07

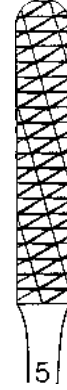

Fig. 5  
37-680-05-07

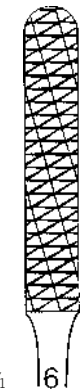

Fig. 6  
37-680-06-07



Fig. 7  
37-680-07-07



Fig. 8  
37-680-08-07



Fig. 9  
37-680-09-07



Fig. 10  
37-680-10-07

7,0 mm  
Maltz  
37-680-01-07 -  
37-680-10-07  
20 cm / 7 7/8"

# Nasenraspeln

Nasal Rasps  
Escofinas nasales  
Râpes nasales  
Raspe nasali

## TC GOLD



37-681-11-07

14 cm / 5 5/8"

Handgriff für TC-Raspeleinsatz  
Handle for TC Inserts  
Mango para escofina TC  
Poignée pour insert de râpe CT  
Manico per inserto raspa TC

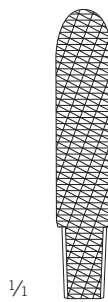

**Fig. 1**  
37-681-01-07  
7 mm

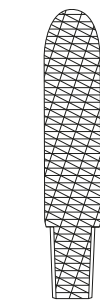

**Fig. 2**  
37-681-02-07  
7 mm

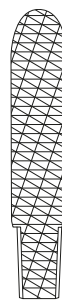

**Fig. 3**  
37-681-03-07  
7 mm



**Fig. 4**  
37-681-04-07  
7 mm

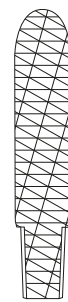

**Fig. 5**  
37-681-05-07  
7 mm

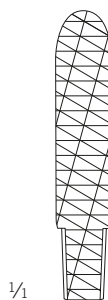

**Fig. 6**  
37-681-06-07  
7 mm

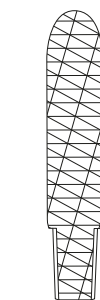

**Fig. 7**  
37-681-07-07  
7 mm



**Fig. 8**  
37-681-08-07  
7 mm



**Fig. 9**  
37-681-09-07  
7 mm

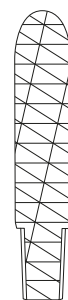

**Fig. 10**  
37-681-10-07  
7 mm



37-681-12-07

15 cm / 5 7/8"

Handgriff für TC-Raspeleinsatz, doppelt  
Handle for TC Inserts, double  
Mango escofina TC, doble extremo  
Poignée pr insert râpe CT, double  
Manico per inserto raspa TC, doppio



37-681-13-07

Schlüssel für Handgriff  
Key for handle  
Llave para mango  
Clé pour poignée  
Chiave per manico



37-681-11-07,  
37-681-12-07

# Nasenraspeln

Nasal Rasps  
Escofinas nasales  
Râpes nasales  
Raspe nasali

# Knochenchirurgie

Bone Surgery  
Cirugía ósea  
Chirurgie osseuse  
Chirurgia ossea

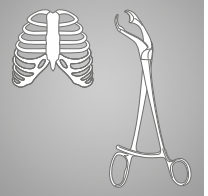

## TC GOLD

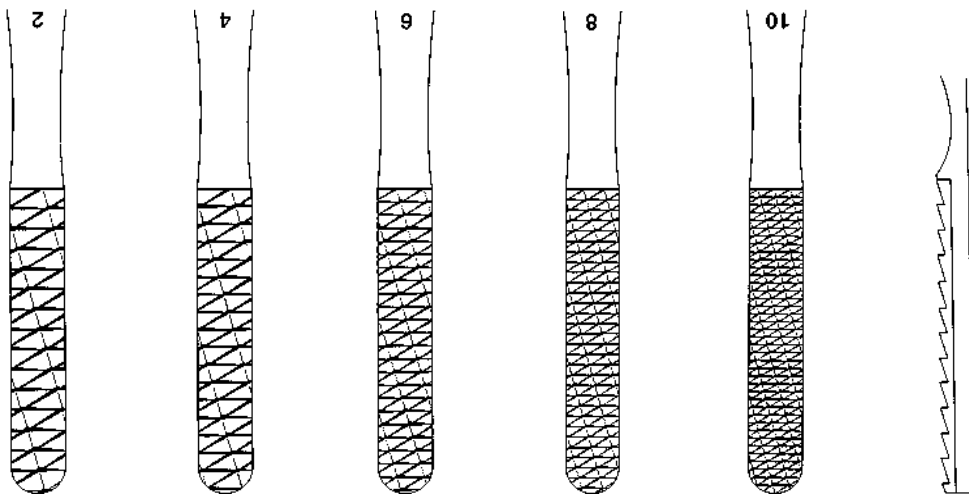
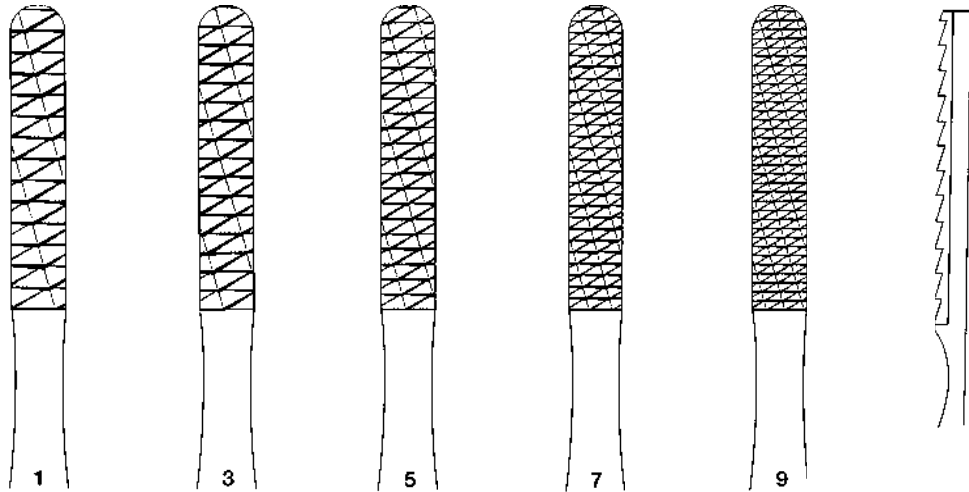

Fig. 1/2  
37-682-01-07  
30 x 8 mm

Fig. 3/4  
37-682-02-07  
40 x 7 mm

Fig. 5/6  
37-682-03-07  
40 x 7 mm

Fig. 7/8  
37-682-04-07  
40 x 7 mm

Fig. 9/10  
37-682-05-07  
40 x 7 mm



Fomon  
37-682-01-07 - 37-682-05-07  
20,5 cm / 8 1/8"

## Elevatorien

Elevators  
Elevadores  
Elévateurs  
Elevatori



1/2

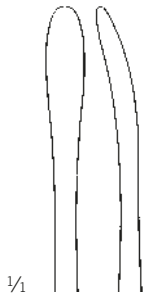

1/1

**5 mm**  
23-499-01-07  
17 cm / 6 5/8"



**7 mm**  
23-499-02-07  
17 cm / 6 5/8"



**8 mm**  
23-499-03-07  
19,5 cm / 7 5/8"

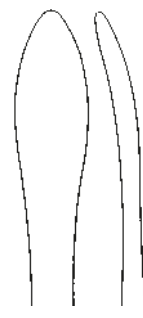

**10 mm**  
23-499-04-07  
19,5 cm / 7 5/8"

Martin-Langenbeck  
23-499-01-07 -  
23-499-04-07

massiv  
solid  
macizo  
solide  
pieno



1/2

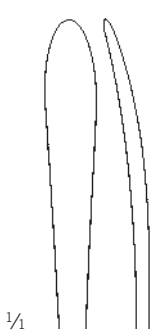

1/1

**7 mm**



1/2

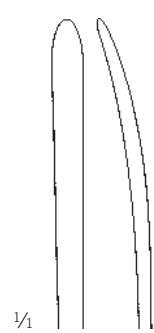

1/1

**4 mm**

Williger  
23-510-17-07  
17 cm / 6 5/8"

massiv  
solid  
macizo  
solide  
pieno

Williger  
23-513-16-07  
16 cm / 6 2/8"

massiv  
solid  
macizo  
solide  
pieno



## Elevatoren, Doppeldissektoren

Elevators, Dissectors, double-ended

Elevadores, Disectores dobles

Elévateurs, Dissecteurs doubles

Elevatori, Dissettori doppi

## Knochenchirurgie

Bone Surgery

Cirugía ósea

Chirurgie osseuse

Chirurgia ossea

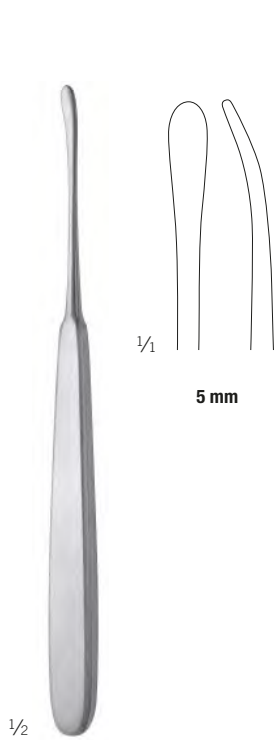
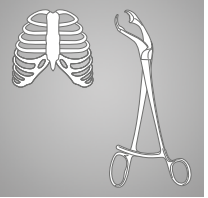

Sebileau  
23-516-18-07  
17,5 cm / 6 7/8"

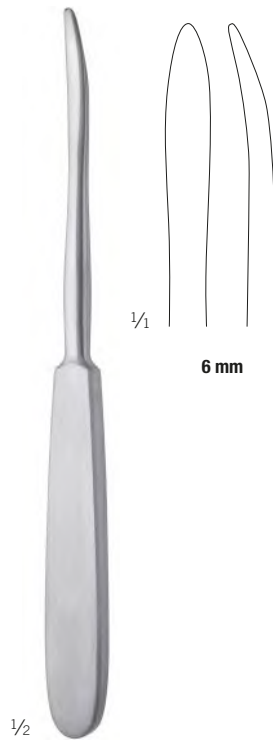

Quervain  
23-517-20-07  
19,5 cm / 7 5/8"

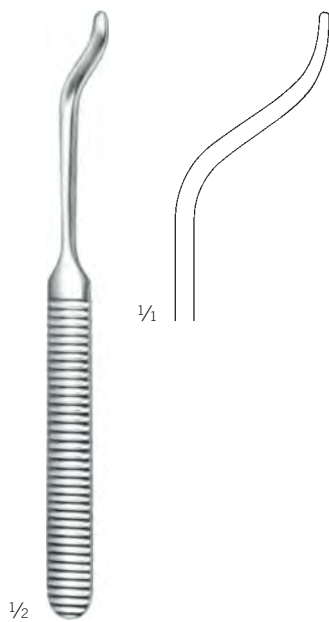

23-523-16-07  
16 cm / 6 2/8"  
Phalangenhebel  
Phalangeal elevator  
Elevador para falanges  
Elévateur pour phalanges  
Divaricatore per falange

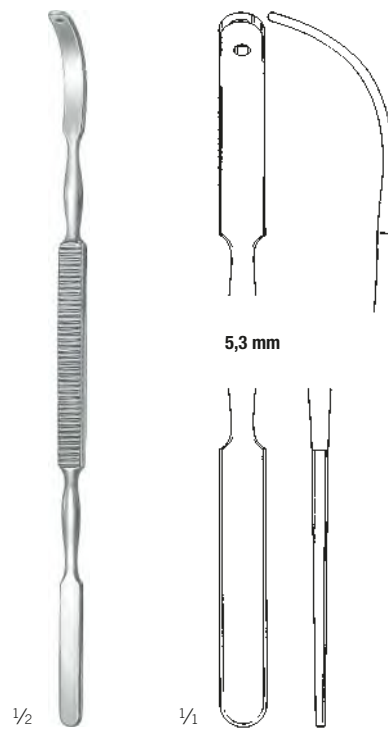

McDonald  
23-527-19-07  
18,5 cm / 7 2/8"

## Septumelevatorien

Septum Elevators

Elevadores para tabique nasal

Élévateurs pour la cloison nasale

Elevatori per il setto nasale

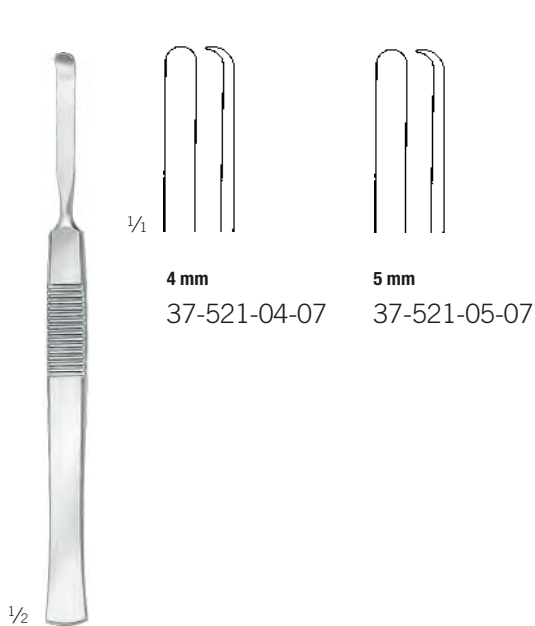

McKenty  
37-521-04-07 -  
37-521-05-07  
15 cm / 5 7/8"

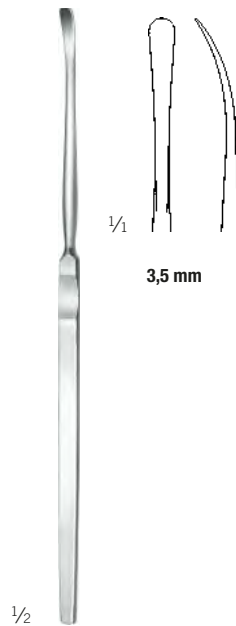

Halle  
37-525-16-07  
16 cm / 6 2/8"

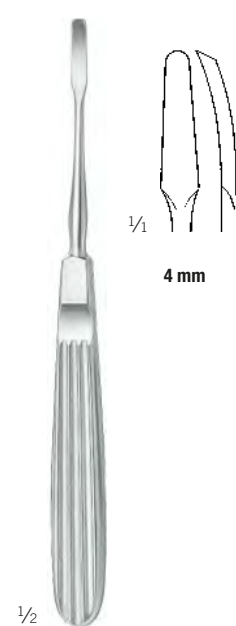

Joseph  
37-531-16-07  
16,5 cm / 6 4/8"

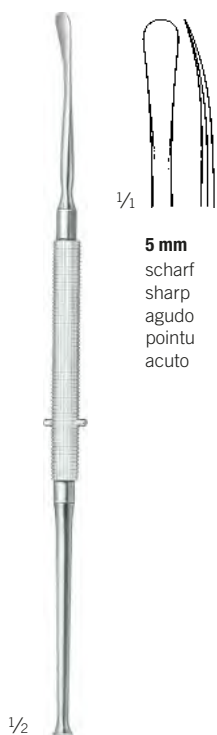

Freer  
37-541-19-07  
19 cm / 7 4/8"

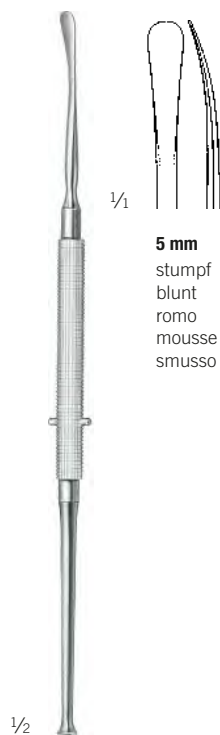

Freer  
37-543-19-07  
19 cm / 7 4/8"



Freer  
37-545-18-07  
18 cm / 7 1/8"

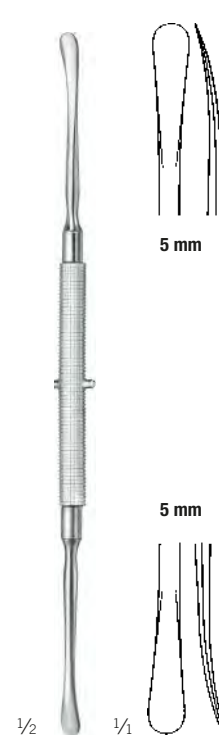

Freer  
37-546-18-07  
18 cm / 7 1/8"

1/2  
5 mm  
scharf  
sharp  
agudo  
pointu  
acuto

1/2  
5 mm  
stumpf  
blunt  
romo  
mousse  
smusso

ohne Stift im Griff, scharf / stumpf  
without pin in handle, sharp / blunt  
sin perno en mango, agudo/romo  
sans boulon dans la manche,  
aigu/mousse  
senza perno nella manico,  
tagliante/smussato

## Septumlevatorien

Septum Elevators

Elevadores para tabique nasal

Élévateurs pour la cloison nasale

Elevatori per il setto nasale

## Knochenchirurgie

Bone Surgery

Cirugía ósea

Chirurgie osseuse

Chirurgia ossea

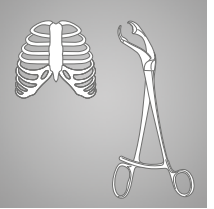

Freer  
37-547-20-07  
21 cm / 8 2/8"



McKenty  
37-549-22-07  
20,5 cm / 8 1/8"

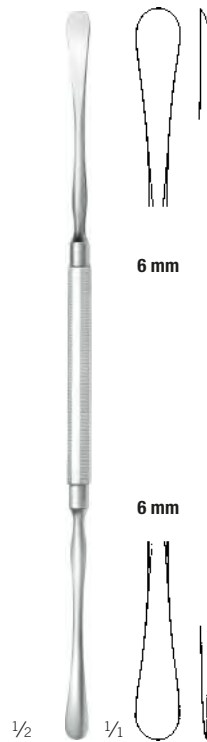

Ballenger-Hajek  
37-550-19-07  
19 cm / 7 4/8"

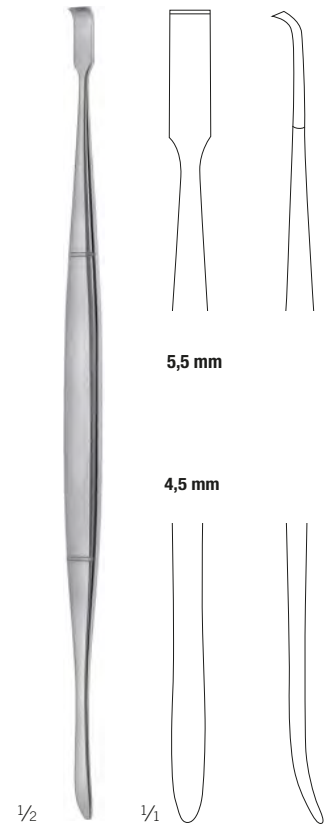

Howard  
37-557-22-07  
21,5 cm / 8 4/8"

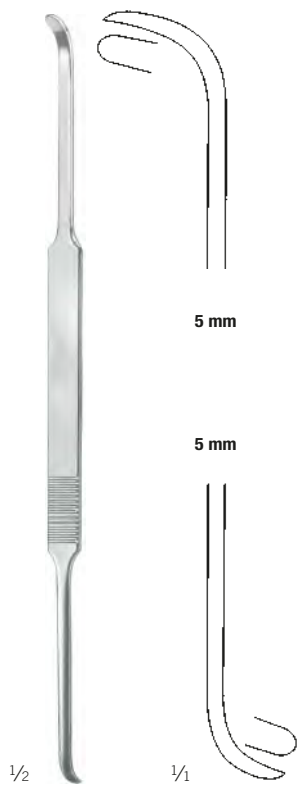

Cottle  
37-559-23-07  
23,5 cm / 9 2/8"

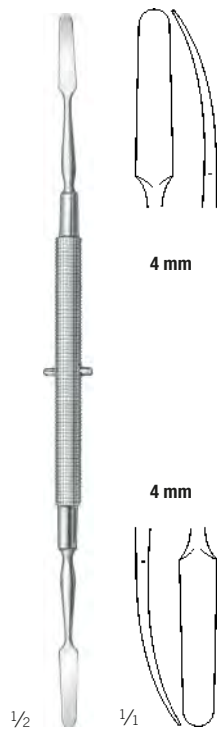

Killian  
37-560-18-07  
18 cm / 7 1/8"

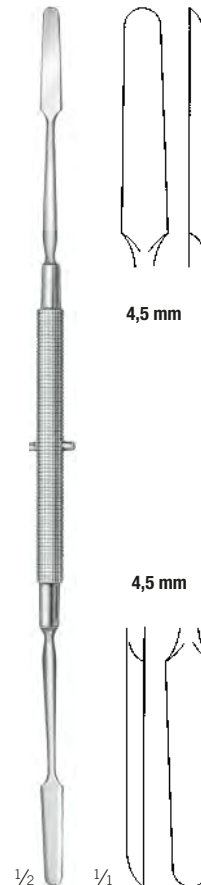

Killian  
37-562-22-07  
23,5 cm / 9 2/8"

## Periostelevatorien

Periosteal Elevators

Legras para periostio

Élévateurs pour le périoste

Elevatori per il periosto

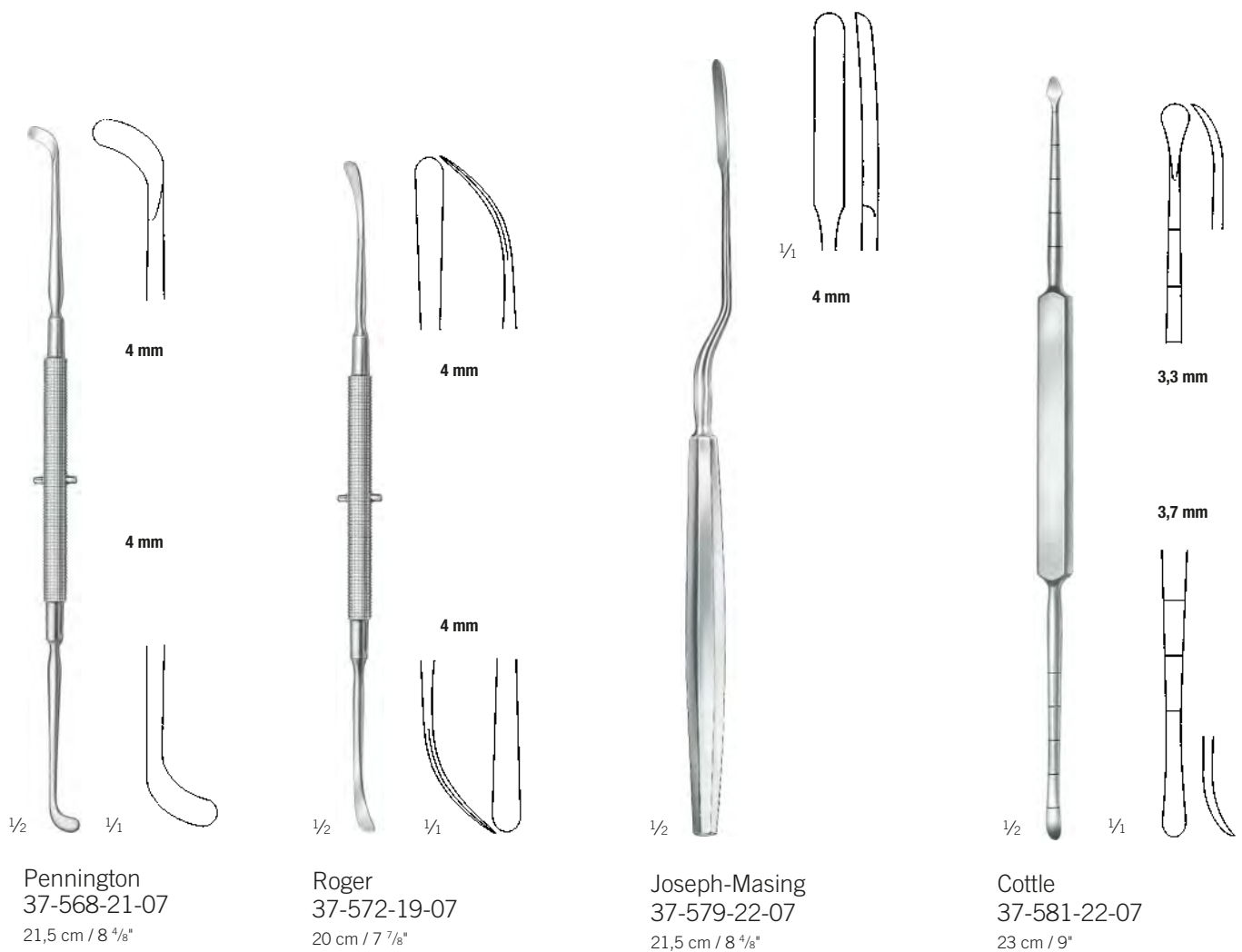

## Periostelevatorien

Periosteal Elevators

Legras para periostio

Élévateurs pour le périoste

Elevatori per il periosto

## Knochenchirurgie

Bone Surgery

Cirugía ósea

Chirurgie osseuse

Chirurgia ossea

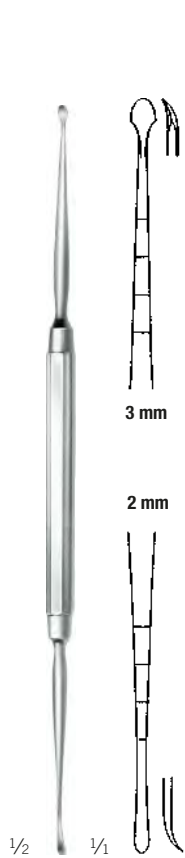
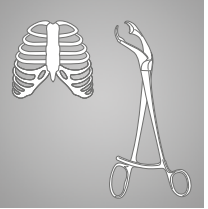

Masing  
37-583-21-07  
19,5 cm / 7 5/8"

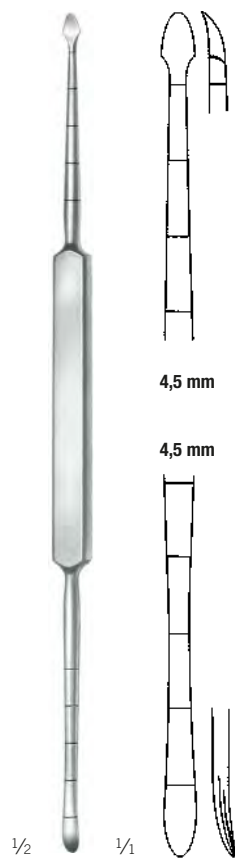

Cottle  
37-584-21-07  
22 cm / 8 5/8"

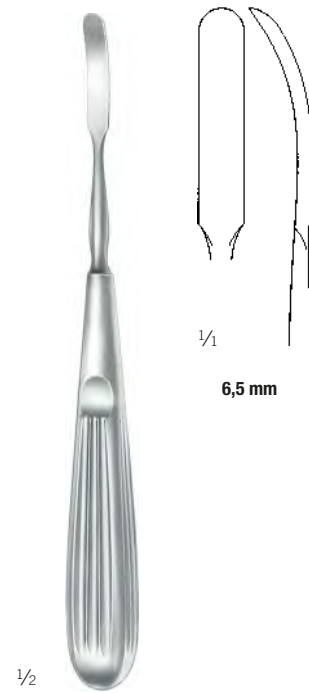

Joseph  
37-585-16-07  
18 cm / 7 1/8"

## Hohlmeißelzangen

Bone Rongeurs

Pinzas gubias

Pinces-gouges

Pinze-sgorbie



23-777-01-07  
17 cm / 6  $\frac{6}{8}$ "

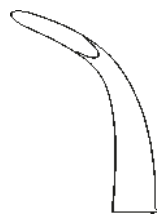

23-777-02-07  
16,5 cm / 6  $\frac{4}{8}$ "



Friedmann  
23-801-14-07  
13,5 cm / 5  $\frac{3}{8}$ "



Mead  
23-815-16-07  
16,5 cm / 6  $\frac{4}{8}$ "



Hartmann  
23-819-18-07  
17,5 cm / 6  $\frac{7}{8}$ "

## Hohlmeißelzangen

Bone Rongeurs  
Pinzas gubias  
Pincès-gouges  
Pinze-sgorbie

## Knochenchirurgie

Bone Surgery  
Cirugía ósea  
Chirurgie osseuse  
Chirurgia ossea

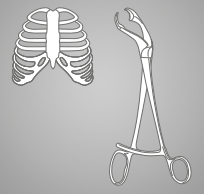

1/2

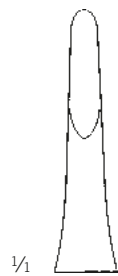

1/4

23-826-18-07  
18 cm / 7 1/8"

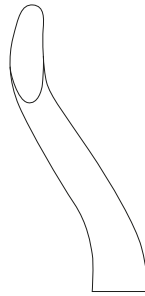

23-828-18-07  
18,5 cm / 7 3/8"



23-829-18-07  
18 cm / 7 1/8"

Jansen  
23-826-18-07 - 23-829-18-07



1/2

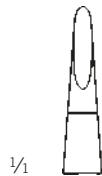

1/4

23-832-19-07

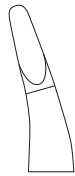

23-833-19-07

Lempert  
23-832-19-07 - 23-833-19-07  
19 cm / 7 4/8"

## Hohlmeißelzangen

Bone Rongeurs

Pinzas gubias

Pinces-gouges

Pinze-sgorbie

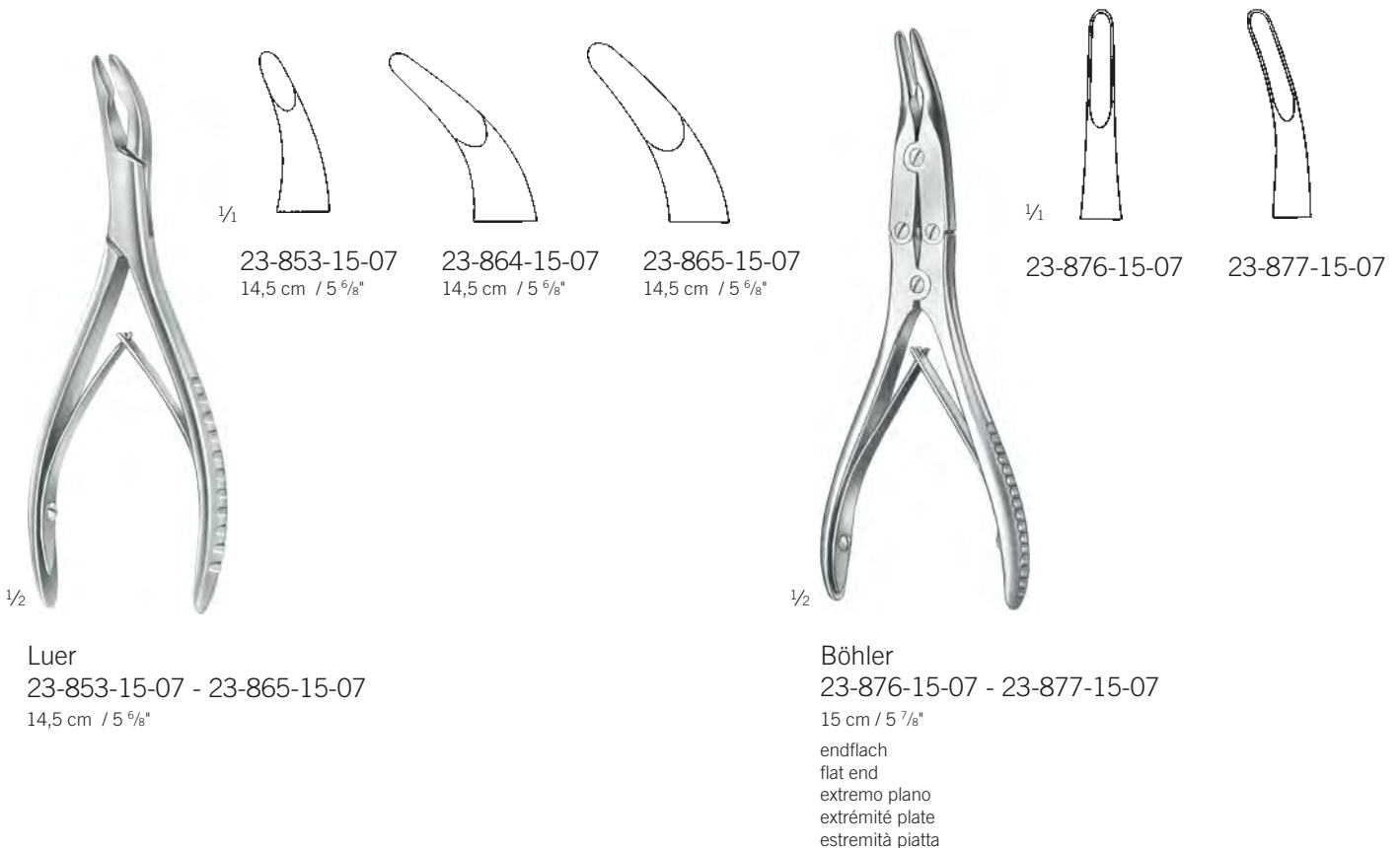
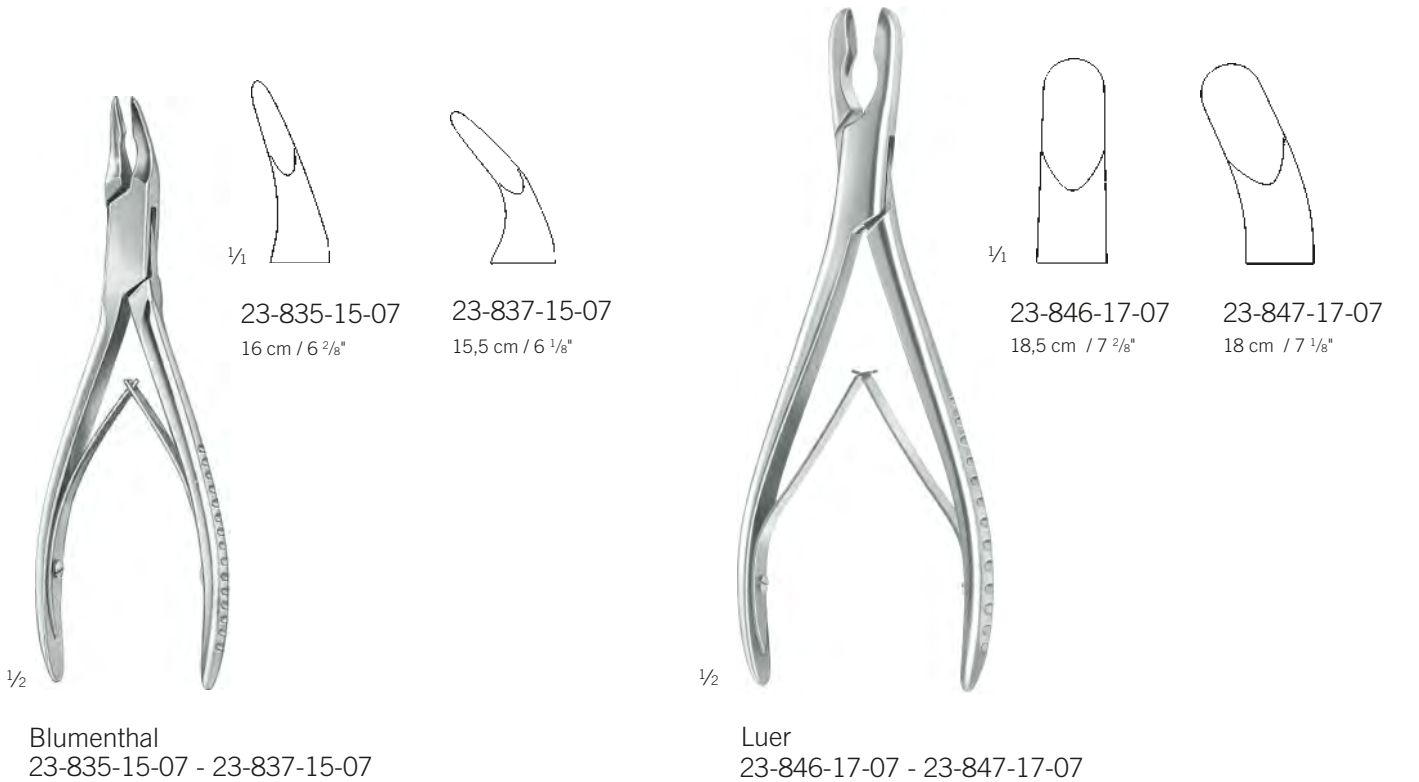



## Hohlmeißelzangen

Bone Rongeurs  
Pinzas gubias  
Pincès-gouges  
Pinze-sgorbie

## Knochenchirurgie

Bone Surgery  
Cirugía ósea  
Chirurgie osseuse  
Chirurgia ossea

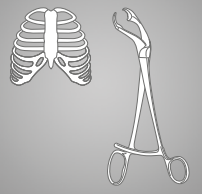

Beyer  
23-879-18-07  
18 cm / 7 1/8"



Zaufal-Jansen  
23-881-18-07  
18 cm / 7 1/8"



Mayfield  
23-883-17-07  
18 cm / 7 1/8"



Marquard  
23-885-20-07  
20,5 cm / 8 1/8"



Ruskin  
23-887-18-07  
19 cm / 7 4/8"

## Hohlmeißelzangen

Bone Rongeurs

Pinzas gubias

Pinces-gouges

Pinze-sgorbie



Ruskin  
23-893-23-07  
24 cm / 9 4/8"

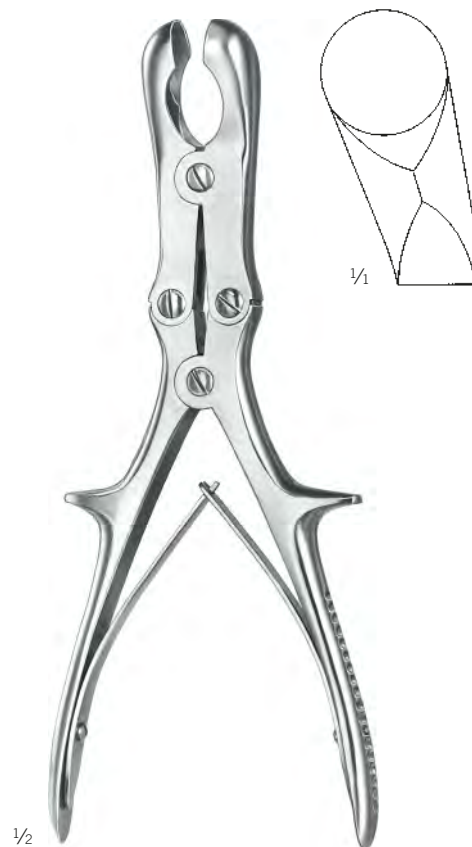

Semb  
23-895-22-07  
23,5 cm / 9 3/8"



Stille  
23-897-23-07  
22,5 cm / 8 7/8"

## Hohlmeißelzangen

Bone Rongeurs  
Pinzas gubias  
Pincers-gouges  
Pinze-sgorbie

## Knochenchirurgie

Bone Surgery  
Cirugía ósea  
Chirurgie osseuse  
Chirurgia ossea

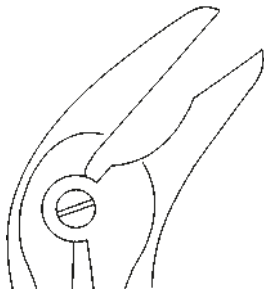
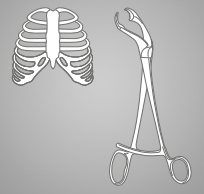

1/2

Echlin

23-899-02-07 - 23-899-04-07

23 cm / 9"

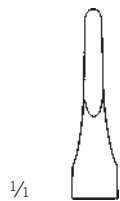

1/4

23-899-02-07



23-899-03-07



23-899-04-07



1/2

Stille-Ruskin

23-901-23-07

23,5 cm / 9 2/8"



1/4

## Hohlmeißelzangen

Bone Rongeurs

Pinzas gubias

Pinces-gouges

Pinze-sgorbie

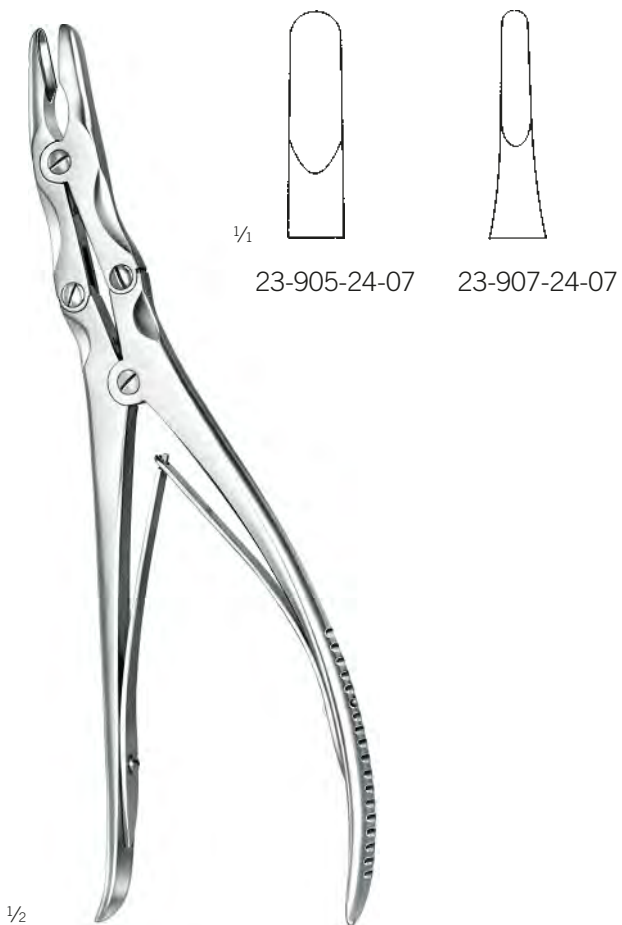

Leksell-Stille  
23-905-24-07 -  
23-907-24-07  
24,5 cm / 9 5/8"



Frykholm  
23-909-24-07  
24,5 cm / 9 5/8"

## Hohlmeißelzangen, Knochensplitterzangen

Bone Rongeurs, Bone Cutting Forceps  
Pinzas gubias, Pinzas cortantes para hueso  
Pincers-gouges, Pincers coupantes à os  
Pinze-sgorbie, Cesioie per ossa

## Knochenchirurgie

Bone Surgery  
Cirugía ósea  
Chirurgie osseuse  
Chirurgia ossea

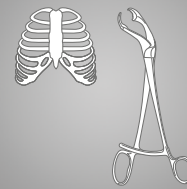

1/1

23-910-22-07

23-911-22-07

1/2

Stille-Luer

23-910-22-07 - 23-911-22-07

22,5 cm / 8 7/8"

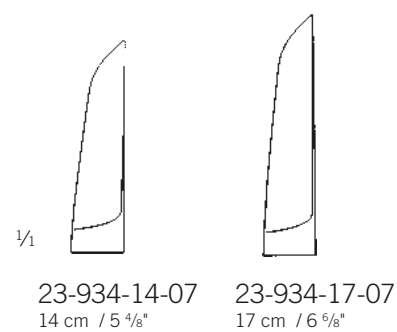

1/1

23-934-14-07

14 cm / 5 4/8"

23-934-17-07

17 cm / 6 5/8"



1/2

Liston

23-934-14-07 -

23-934-22-07



23-934-19-07

20 cm / 7 7/8"



23-934-22-07

22 cm / 8 5/8"

## Knochensplitterzangen

Bone Cutting Forceps

Pinzas cortantes para hueso

Pinces coupantes à os

Cesoie per ossa

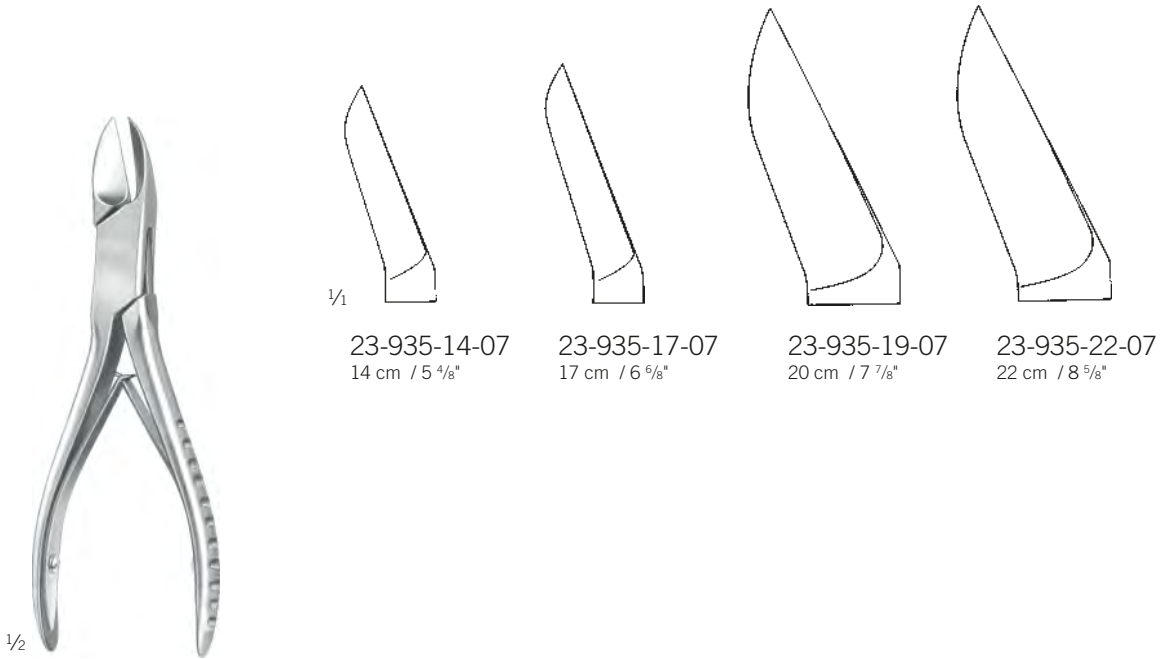

Liston  
23-935-14-07 -  
23-935-22-07

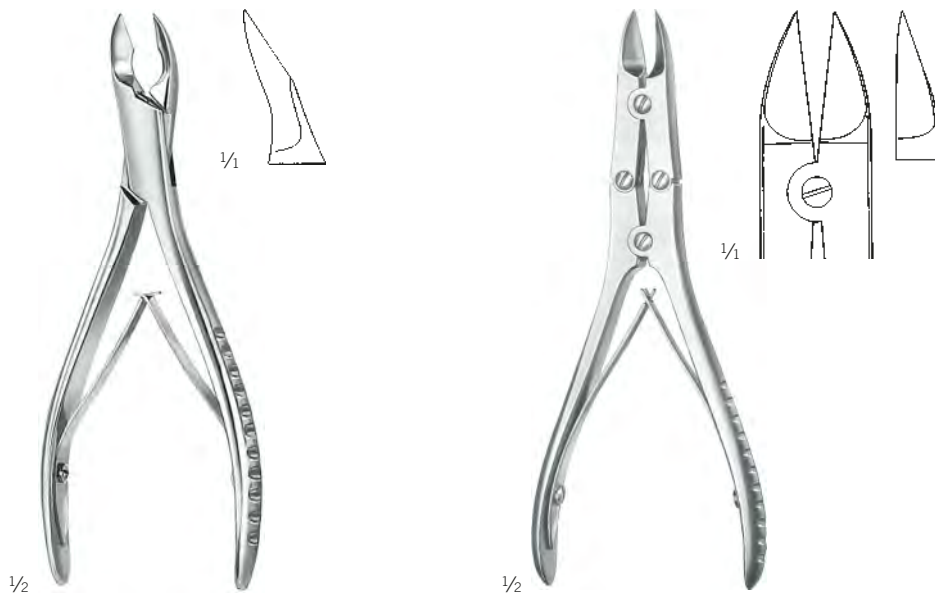

Cleveland  
23-941-15-07  
14,5 cm / 5 5/8"

Böhler  
23-946-15-07  
14,5 cm / 5 5/8"

# Knochensplitterzangen

Bone Cutting Forceps  
Pinzas cortantes para hueso  
Pincers coupantes à os  
Cesoie per ossa

# Knochenchirurgie

Bone Surgery  
Cirugía ósea  
Chirurgie osseuse  
Chirurgia ossea

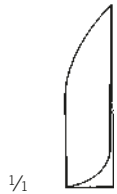
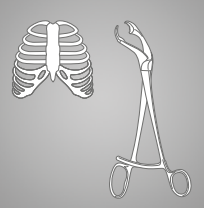

1/1

23-950-18-07  
19 cm / 7 4/8"



23-951-18-07  
18,5 cm / 7 2/8"



1/2

Ruskin-Liston  
23-950-18-07 -  
23-951-18-07

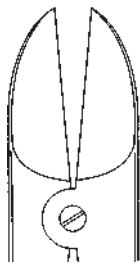

1/1

23-955-23-07  
23,5 cm / 10 2/8"



23-955-27-07  
28 cm / 11 "



1/2

Stille-Liston  
23-955-23-07 -  
23-955-27-07

## Drahtsägen, Schädelzangen

Wire Saws, Cranial Rongeurs

Sierras de hilo, Pinzas sacabocados craneales

Fils-scies, Pincers emporte-pièces crâniennes

Fili sega, Pinze per craniectomia



24-600-30-07  
30 cm / 11 <sup>5</sup>/<sub>8</sub>"

24-600-40-07  
40 cm / 15 <sup>5</sup>/<sub>8</sub>"

24-600-50-07  
50 cm / 19 <sup>5</sup>/<sub>8</sub>"

24-600-60-07  
60 cm / 23 <sup>5</sup>/<sub>8</sub>"

24-600-70-07  
70 cm / 27 <sup>4</sup>/<sub>8</sub>"

1/2

Gigli  
24-600-30-07- 24-600-70-07

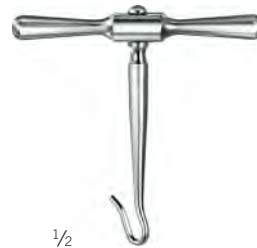

1/2

Gigli  
24-602-01-01



1/2

De Martel  
24-618-33-07

33 cm / 13"

Einführinstrument

Wire saw guide

Conductor para sierras de hilo

Conducteur pour fils-scies

Introduttore



Dahlgren  
24-654-20-07

19,5 cm / 7 <sup>5</sup>/<sub>8</sub>"

mit 3 Haken  
with 3 hooks  
con 3 ganchos  
avec 3 crochets  
con 3 ganci

1/2



De Vilbiss  
24-658-21-07

21 cm / 8 <sup>2</sup>/<sub>8</sub>"

mit 2 Haken  
with 2 hooks  
con 2 ganchos  
avec 2 crochets  
con 2 ganci

1/2



## Clips und Anlegezangen

Clips and Applying Forceps  
Grapas y pinzas aplicadoras  
Clips et pinces pour appliquer  
Agrafes e pinze per applicare

## Knochenchirurgie

Bone Surgery  
Cirugía ósea  
Chirurgie osseuse  
Chirurgia ossea

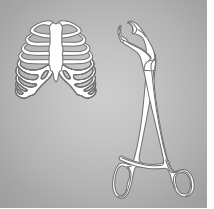

1/1

Raney

24-675-00-07

Kopfhautklammer  
Scalp clip  
Grapa para cuero cabelludo  
Agrafes pour cuir chevelu  
Pinze per il cuoio capelluto



1/2

Raney

24-676-00-07

15,5 cm / 6"  
Anlege- und Abnehmzange  
Applying/removal forceps  
Pinza para aplicar y quitar agrafes  
Pince pour appliquer et enlever les  
clips hémostatiques  
Pinza per applicare e togliere le agrafe  
emostatiche



1/2



24-678-01-07  
30 cm / 11 5/8"

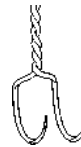

1/1

24-678-02-07  
41 cm / 16 1/8"

Yasargil

24-678-01-07 - 24-678-02-07

Galeahaken  
Galea hook  
Gancho Galea  
Ecarteur Galea  
Divaricatore Galea

## Dissektoren

Dissectors  
Disecadores  
Dissecteurs  
Dissettori



Toennis  
24-680-25-07  
24 cm / 9 4/8"

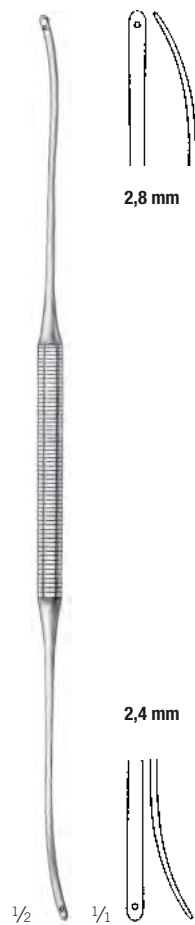

Olivecrona  
24-681-24-07  
24 cm / 9 4/8"



Olivecrona  
24-682-18-07  
18 cm / 7 1/8"

## Dissektoren

Dissectors  
Disecadores  
Dissecteurs  
Dissettori

## Knochenchirurgie

Bone Surgery  
Cirugía ósea  
Chirurgie osseuse  
Chirurgia ossea

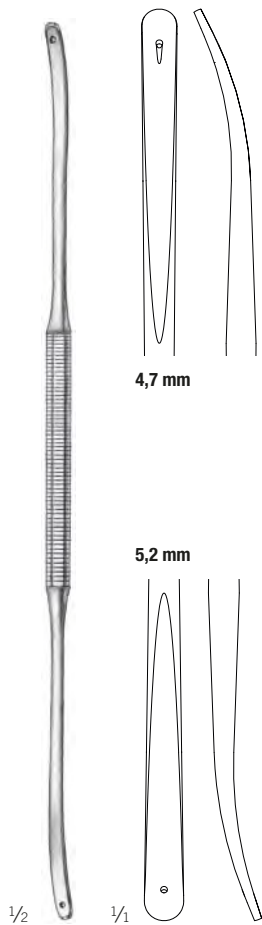
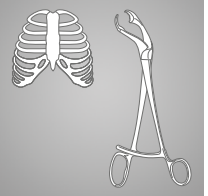

4,7 mm

5,2 mm

Olivecrona  
24-683-24-07  
24 cm / 9 1/8"



4,5 mm

5,0 mm

Olivecrona  
24-684-19-07  
20 cm / 7 7/8"



1/2

3,0 mm

Sachs  
24-685-21-07  
20,5 cm / 8 1/8"

## Dissektoren

Dissectors  
Disecadores  
Dissecteurs  
Dissettori

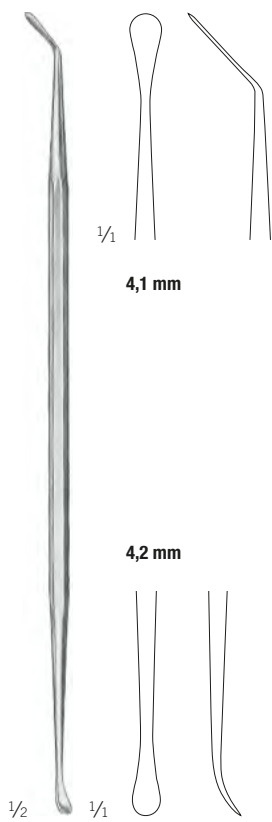

Milligan  
24-686-21-07  
21,5 cm / 8 5/8"

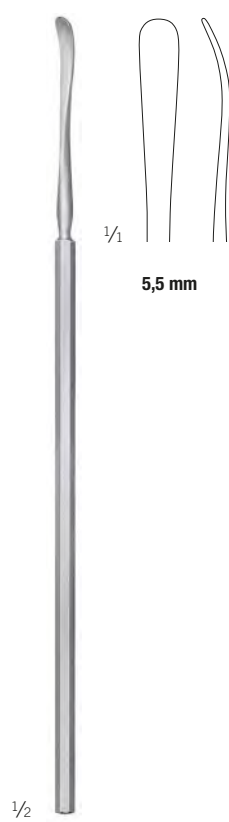

Davis  
24-687-21-07  
21,5 cm / 8 4/8"

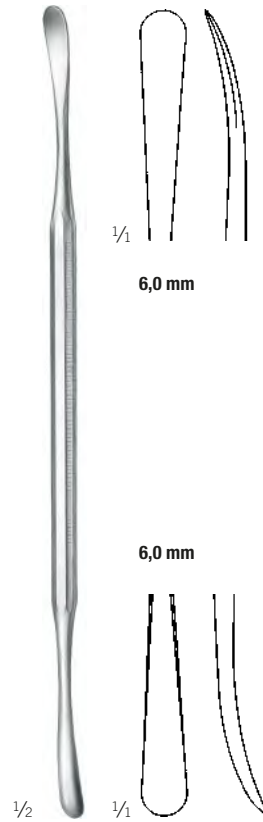

24-688-22-07  
22 cm / 8 5/8"



Davis  
24-691-24-07  
24,5 cm / 9 5/8"

# Dissektoren

Dissectors  
Disecadores  
Dissecteurs  
Dissettori

# Knochenchirurgie

Bone Surgery  
Cirugía ósea  
Chirurgie osseuse  
Chirurgia ossea

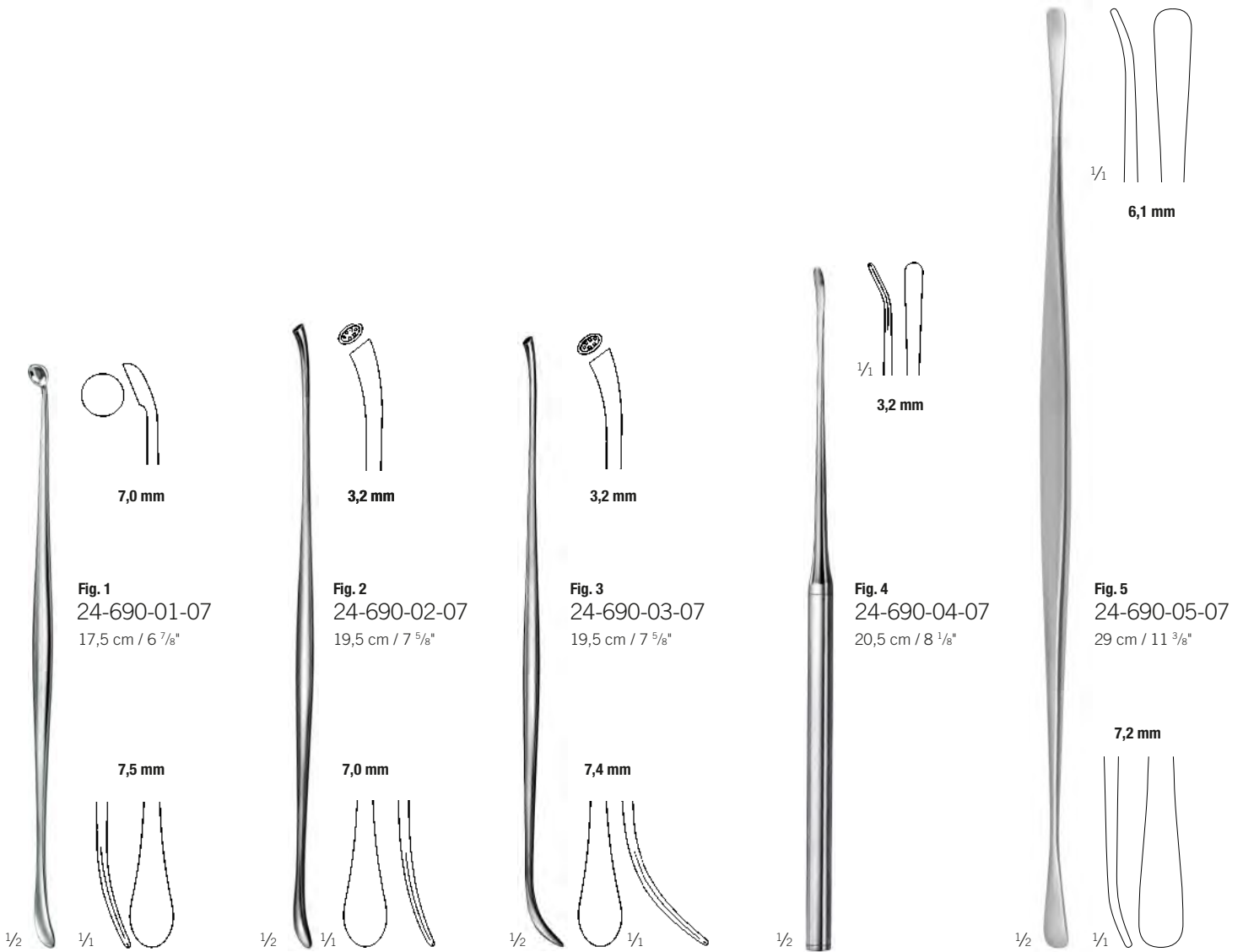
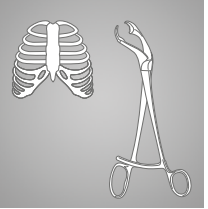

Penfield  
24-690-01-07 -  
24-690-05-07



---

Verschiedenes  
Miscellaneous  
Diversos artículos  
Articles divers  
Articoli diversi

## Spezial-Produkte

Special Products  
Productos especiales  
Produits spéciaux  
Prodotti speciali

---

Informationen zu den KLS-Martin-Elektrochirurgie-Systemen entnehmen Sie bitte den separaten Katalogen bzw. Broschüren:

- Zubehör für die Hochfrequenzchirurgie
- Elektrochirurgiegerät maxium®

Please refer to the separate catalogs and brochures for information about KLS-Martin electrosurgery systems:

- Accessories for Electrosurgery
- Electrosurgery device maxium®

Encontrará información sobre los sistemas de electrocirugía de KLS-Martin en los catálogos o folletos específicos:

- Accesorios para la electrocirugía
- Aparato de electrocirugía maxium®

Veillez vous reporter aux catalogues ou brochures séparés pour obtenir des informations détaillées à propos des systèmes d'électrochirurgie KLS Martin:

- Accessoires électrochirurgicaux
- Dispositif d'électrochirurgie maxium®

Per informazioni sui sistemi di elettrochirurgia di KLS Martin, consultare i cataloghi e/o le brochure separati:

- Accessori per elettrochirurgia
- Apparocchio elettrochirurgico maxium®





## Spezial-Produkte

Special Products  
Productos especiales  
Produits spéciaux  
Prodotti speciali

Informationen zu den KLS-Martin-Osteosynthese-Systemen entnehmen Sie bitte den separaten Broschüren:

- IPS Implants® Cranium
- SAM – Standard Approach Mesh
- Low Profile Neuro System
- Steriles Neuro Flap Fix Kit

Please refer to the separate brochures for information about KLS Martin osteosynthesis systems:

- IPS Implants® Cranium
- SAM – Standard Approach Mesh
- Low Profile Neuro System
- Sterile Neuro Flap Fix Kit

Encontrará información sobre los sistemas de osteosíntesis de KLS Martin en los folletos específicos:

- IPS Implants® Cranium
- SAM – Standard Approach Mesh
- Sistema Low Profile Neuro
- Neuro Flap Fix Kit estéril

Veuillez vous reporter aux brochures séparées pour obtenir des informations détaillées à propos ostéosynthèse KLS Martin:

- IPS Implants® Cranium
- SAM – Standard Approach Mesh
- Système Low Profile Neuro
- Neuro Flap Fix Kit stérile

Per informazioni sui sistemi osteosintesi di KLS Martin, consultare le brochure separate:

- IPS Implants® Cranium
- SAM – Standard Approach Mesh
- Sistema Low Profile Neuro
- Kit sterile Flap Fix per neurochirurgia

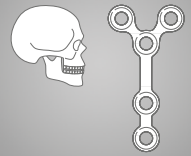

## Spezial-Produkte

Special Products  
Productos especiales  
Produits spéciaux  
Prodotti speciali

Informationen zu den Distraktoren und Osteosynthese-Systemen von KLS Martin entnehmen Sie bitte den separaten Broschüren:

- Cranial Distraction (Kawamoto, Posterior Cranial Vault Distractor)
- L1® Cranium – Neuro-Osteosynthese
- CranioXpand – Kraniale Federn zur Behandlung von sagittalen Kraniosynostosen
- Level One Fixation – Osteosynthese 1.5 Mikro

Please refer to the separate brochures for information about KLS Martin distractors and osteosynthesis systems:

- Cranial Distraction (Kawamoto, Posterior Cranial Vault Distractor)
- L1® Cranium – Neuro Osteosynthesis
- CranioXpand – Cranial springs for the treatment of sagittal craniosynostoses
- Level One Fixation – Osteosynthesis 1.5 Micro

Encontrará información sobre los distractores y los sistemas de osteosíntesis de KLS Martin en los folletos específicos:

- Cranial Distraction (Kawamoto, Posterior Cranial Vault Distractor)
- L1® Cranium – Neuro-osteosíntesis
- CranioXpand – Cranial springs for the treatment of sagittal craniosynostoses
- Level One Fixation – Osteosíntesis 1.5 Micro

Veuillez vous reporter aux brochures séparées pour obtenir des informations détaillées à propos des distracteurs aux ostéosynthèse de KLS Martin:

- Cranial Distraction (Kawamoto, Posterior Cranial Vault Distractor)
- L1® Cranium – Neuro-ostéosynthèse
- CranioXpand – Cranial springs for the treatment of sagittal craniosynostoses
- Level One Fixation – Ostéosynthèse 1.5 Micro

Per informazioni sui distrattori e sistemi osteosintesi di KLS Martin, consultare le brochure separata:

- Cranial Distraction (Kawamoto, Posterior Cranial Vault Distractor)
- L1® Cranium – Neuro-osteosintesi
- CranioXpand – Cranial springs for the treatment of sagittal craniosynostoses
- Level One Fixation – Osteosintesi 1.5 Micro

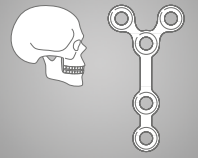

## **SonicWeld Rx®** – Die Revolution der Osteosynthese

KLS Martin hat mit SonicWeld Rx® ein revolutionäres System für die Kieferknochenaugmentation entwickelt. Mit modernster Ultraschalltechnik, kombiniert mit resorbierbaren Implantaten, wird die Metallentfernung überflüssig. Dank des völlig neuen Verschweißungsprozesses verankert sich das resorbierbare Material tief in der Knochenstruktur und erzeugt eine bislang ungekannte Primärstabilität. In der präprothetischen Augmentation eignet sich das System für resorbierbare Membranfixierungen (Guided Bone Regeneration), Auflagerungen (Onlay Grafts) und Schalungen (Split Grafts).



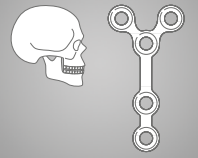

EN

**Sonic Weld Rx® –  
 The revolution in osteosynthesis**

With SonicWeld Rx®, KLS Martin offers a revolutionary system for jaw bone augmentation. Highly advanced ultrasound technology combined with resorbable implants makes the metal removal redundant. Thanks to the completely novel welding technique, the bioabsorbable material penetrates deeply into the bone structure to provide a level of primary stability never seen before. In preprosthetic augmentation, this system can be used for resorbable membrane fixation (guided bone regeneration), appositions (onlay grafts) procedures based on the innovative shell technique (split grafts).

ES

**Sonic Weld Rx® –  
 La revolución de la osteosíntesis**

Con SonicWeld Rx®, KLS Martin ha diseñado un sistema revolucionario para el aumento del hueso maxilar. La más avanzada tecnología de ultrasonidos, combinada con implantes reabsorbibles, hace innecesaria la eliminación de metales. Gracias al innovador proceso de soldadura, el material reabsorbible se ancla profundamente en la estructura ósea y proporciona una estabilidad primaria sin precedentes. En el aumento preprotésico, este sistema es apropiado para fijaciones de membranas reabsorbibles (guided bone regeneration - regeneración ósea guiada), aposiciones (onlay grafts) y la técnica de valva (split grafts).

FR

**Sonic Weld Rx® –  
 La révolution de l'ostéosynthèse**

KLS Martin a mis au point, avec SonicWeld Rx®, un système révolutionnaire pour l'augmentation de la masse osseuse de la mâchoire. Avec une technique à ultrasons ultrasonde, associée à des implants résorbables, le retrait du métal devient superflu. Grâce au tout nouveau processus de soudage, le matériau résorbable s'ancre en profondeur dans la structure osseuse et génère une stabilité primaire jusqu'à présent inconnue. Dans le cadre de l'augmentation pré-prothétique, le système est adapté pour les régénérations osseuses guidées (guided bone regeneration), les greffes osseuses (onlay grafts) et les greffes fendues (split grafts).

IT

**Sonic Weld Rx® –  
 La rivoluzione dell'osteosintesi**

KLS Martin ha sviluppato con SonicWeld Rx® un sistema rivoluzionario per l'aumento dell'osso mascellare. La più moderna tecnologia ad ultrasuoni, abbinata a impianti riassorbibili, rende superflua la rimozione del metallo. Grazie al processo di saldatura completamente rinnovato, il materiale riassorbibile si ancora profondamente alla struttura ossea raggiungendo una stabilità primaria finora mai vista. Nella fase di aumento pre-protetica, questo sistema è indicato per fissaggi riassorbibili di membrane (guided bone regeneration), apposizioni (onlay grafts) e gusci (split grafts).





---

Nummern-Index  
Index of order numbers  
Índice de números de referencia  
Index numérique des références de commande  
Elenco dei codici



# Nummern-Index

Index of order numbers

Índice de números de referencia

Index numérique des références de commande

Elenco dei codici

## 10

|                   |    |
|-------------------|----|
| 10-100-04-0.....  | 78 |
| 10-104-41-07..... | 78 |
| 10-130-03-07..... | 78 |
| 10-133-31-07..... | 78 |
| 10-135-01-07..... | 79 |
| 10-137-07-07..... | 79 |
| 10-155-10-04..... | 80 |
| 10-155-11-04..... | 80 |
| 10-155-12-04..... | 80 |
| 10-155-15-04..... | 80 |
| 10-155-18-04..... | 80 |
| 10-155-20-04..... | 80 |
| 10-155-22-04..... | 80 |
| 10-155-23-04..... | 80 |
| 10-155-24-04..... | 80 |
| 10-155-36-04..... | 80 |
| 10-156-12-04..... | 80 |
| 10-156-15-04..... | 80 |
| 10-160-01-07..... | 79 |
| 10-199-00-01..... | 80 |
| 10-285-20-04..... | 81 |
| 10-285-21-04..... | 81 |
| 10-285-22-04..... | 81 |
| 10-285-23-04..... | 81 |
| 10-285-24-04..... | 81 |
| 10-295-10-04..... | 82 |
| 10-295-11-04..... | 82 |
| 10-295-12-04..... | 82 |
| 10-295-15-04..... | 82 |
| 10-296-12-04..... | 82 |
| 10-296-15-04..... | 82 |

## 11

|                   |    |
|-------------------|----|
| 11-100-11-07..... | 84 |
| 11-100-13-07..... | 84 |
| 11-100-14-07..... | 84 |
| 11-100-16-07..... | 84 |
| 11-100-18-07..... | 84 |
| 11-100-20-07..... | 84 |
| 11-102-11-07..... | 85 |
| 11-102-13-07..... | 85 |
| 11-102-14-07..... | 85 |
| 11-102-16-07..... | 85 |
| 11-102-18-07..... | 85 |
| 11-102-20-07..... | 85 |
| 11-104-11-07..... | 86 |
| 11-104-13-07..... | 86 |
| 11-104-14-07..... | 86 |
| 11-104-16-07..... | 86 |
| 11-105-11-07..... | 87 |
| 11-105-13-07..... | 87 |
| 11-105-14-07..... | 87 |
| 11-105-16-07..... | 87 |
| 11-105-18-07..... | 87 |
| 11-105-20-07..... | 87 |
| 11-107-11-07..... | 88 |
| 11-107-13-07..... | 88 |
| 11-107-14-07..... | 88 |
| 11-107-18-07..... | 88 |
| 11-107-20-07..... | 88 |
| 11-109-11-07..... | 89 |
| 11-109-13-07..... | 89 |
| 11-109-14-07..... | 89 |
| 11-109-16-07..... | 89 |
| 11-136-14-07..... | 90 |
| 11-140-14-07..... | 90 |
| 11-170-14-07..... | 91 |
| 11-170-17-07..... | 91 |
| 11-170-23-07..... | 91 |
| 11-171-14-07..... | 92 |
| 11-171-17-07..... | 92 |
| 11-171-23-07..... | 92 |
| 11-180-17-07..... | 93 |
| 11-181-15-07..... | 94 |
| 11-181-17-07..... | 94 |
| 11-184-19-07..... | 93 |
| 11-185-19-07..... | 94 |
| 11-185-21-07..... | 94 |

|                   |     |
|-------------------|-----|
| 11-190-17-07..... | 95  |
| 11-191-17-07..... | 95  |
| 11-226-16-07..... | 96  |
| 11-227-16-07..... | 97  |
| 11-248-11-07..... | 98  |
| 11-249-11-07..... | 99  |
| 11-250-14-07..... | 98  |
| 11-252-14-07..... | 100 |
| 11-254-14-07..... | 100 |
| 11-255-14-07..... | 99  |
| 11-257-14-07..... | 100 |
| 11-259-14-07..... | 100 |
| 11-264-15-07..... | 101 |
| 11-265-15-07..... | 102 |
| 11-280-18-07..... | 101 |
| 11-280-20-07..... | 101 |
| 11-280-23-07..... | 101 |
| 11-280-25-07..... | 101 |
| 11-280-28-07..... | 101 |
| 11-280-30-07..... | 101 |
| 11-284-18-07..... | 104 |
| 11-284-20-07..... | 104 |
| 11-285-18-07..... | 102 |
| 11-285-20-07..... | 102 |
| 11-285-23-07..... | 102 |
| 11-285-25-07..... | 102 |
| 11-285-28-07..... | 102 |
| 11-285-30-07..... | 102 |
| 11-298-14-07..... | 104 |
| 11-299-14-07..... | 104 |
| 11-300-15-07..... | 104 |
| 11-301-15-07..... | 104 |
| 11-302-15-07..... | 104 |
| 11-310-16-07..... | 105 |
| 11-311-16-07..... | 106 |
| 11-314-18-07..... | 108 |
| 11-314-21-07..... | 108 |
| 11-314-24-07..... | 108 |
| 11-316-17-07..... | 109 |
| 11-316-20-07..... | 109 |
| 11-317-11-07..... | 110 |
| 11-317-14-07..... | 110 |
| 11-320-10-07..... | 111 |
| 11-321-10-07..... | 112 |
| 11-324-16-07..... | 113 |
| 11-325-16-07..... | 113 |
| 11-326-14-07..... | 114 |
| 11-327-14-07..... | 115 |
| 11-328-14-07..... | 116 |
| 11-329-14-07..... | 117 |
| 11-329-18-07..... | 117 |
| 11-329-20-07..... | 117 |
| 11-330-18-07..... | 114 |
| 11-330-20-07..... | 114 |
| 11-330-23-07..... | 114 |
| 11-331-18-07..... | 115 |
| 11-331-20-07..... | 115 |
| 11-331-23-07..... | 115 |
| 11-335-18-07..... | 118 |
| 11-335-20-07..... | 118 |
| 11-335-23-07..... | 118 |
| 11-350-14-07..... | 119 |
| 11-351-14-07..... | 119 |
| 11-358-13-07..... | 120 |
| 11-364-14-07..... | 121 |
| 11-364-15-07..... | 121 |
| 11-364-18-07..... | 121 |
| 11-365-14-07..... | 122 |
| 11-365-15-07..... | 122 |
| 11-365-18-07..... | 122 |
| 11-367-14-07..... | 123 |
| 11-369-14-07..... | 123 |
| 11-370-01-07..... | 38  |
| 11-370-02-07..... | 38  |
| 11-371-01-07..... | 38  |
| 11-371-02-07..... | 38  |
| 11-371-03-07..... | 38  |
| 11-371-04-07..... | 38  |
| 11-371-05-07..... | 38  |
| 11-371-06-07..... | 38  |

|                   |     |
|-------------------|-----|
| 11-371-07-07..... | 38  |
| 11-371-08-07..... | 38  |
| 11-384-25-07..... | 39  |
| 11-384-45-07..... | 39  |
| 11-384-60-07..... | 39  |
| 11-384-90-07..... | 39  |
| 11-385-00-07..... | 39  |
| 11-400-25-07..... | 39  |
| 11-400-45-07..... | 39  |
| 11-400-60-07..... | 39  |
| 11-400-90-07..... | 39  |
| 11-401-00-07..... | 39  |
| 11-412-25-07..... | 39  |
| 11-412-45-07..... | 39  |
| 11-412-60-07..... | 39  |
| 11-412-90-07..... | 39  |
| 11-413-00-07..... | 39  |
| 11-436-25-07..... | 39  |
| 11-436-45-07..... | 39  |
| 11-436-60-07..... | 39  |
| 11-436-90-07..... | 39  |
| 11-437-00-07..... | 39  |
| 11-445-22-07..... | 123 |
| 11-446-22-07..... | 123 |
| 11-455-17-07..... | 123 |
| 11-459-17-07..... | 124 |
| 11-475-23-07..... | 125 |
| 11-630-11-07..... | 126 |
| 11-631-11-07..... | 127 |
| 11-650-14-07..... | 85  |
| 11-651-14-07..... | 88  |
| 11-652-14-07..... | 91  |
| 11-652-17-07..... | 91  |
| 11-652-23-07..... | 91  |
| 11-653-14-07..... | 92  |
| 11-653-17-07..... | 92  |
| 11-653-23-07..... | 92  |
| 11-654-15-07..... | 93  |
| 11-654-17-07..... | 93  |
| 11-655-15-07..... | 94  |
| 11-655-17-07..... | 94  |
| 11-656-16-07..... | 96  |
| 11-657-16-07..... | 97  |
| 11-658-11-07..... | 98  |
| 11-659-11-07..... | 99  |
| 11-659-14-07..... | 99  |
| 11-660-18-07..... | 101 |
| 11-660-20-07..... | 101 |
| 11-660-23-07..... | 101 |
| 11-660-26-07..... | 101 |
| 11-660-28-07..... | 101 |
| 11-660-31-07..... | 101 |
| 11-661-18-07..... | 102 |
| 11-661-20-07..... | 102 |
| 11-661-23-07..... | 102 |
| 11-661-26-07..... | 102 |
| 11-661-28-07..... | 102 |
| 11-661-31-07..... | 102 |
| 11-662-10-07..... | 111 |
| 11-662-16-07..... | 105 |
| 11-663-10-07..... | 112 |
| 11-663-16-07..... | 106 |
| 11-665-14-07..... | 115 |
| 11-665-18-07..... | 115 |
| 11-665-20-07..... | 115 |
| 11-665-23-07..... | 115 |
| 11-666-14-07..... | 119 |
| 11-667-14-07..... | 119 |
| 11-671-15-07..... | 122 |
| 11-671-18-07..... | 122 |
| 11-672-11-07..... | 126 |
| 11-673-11-07..... | 127 |
| 11-674-10-07..... | 129 |
| 11-675-10-07..... | 129 |
| 11-676-10-07..... | 128 |
| 11-677-10-07..... | 128 |
| 11-678-10-07..... | 128 |
| 11-679-10-07..... | 128 |
| 11-680-11-07..... | 129 |
| 11-681-11-07..... | 129 |

|                   |         |
|-------------------|---------|
| 11-682-11-07..... | 128     |
| 11-683-11-07..... | 128     |
| 11-710-15-07..... | 40      |
| 11-710-18-07..... | 40      |
| 11-710-19-07..... | 40      |
| 11-711-15-07..... | 40      |
| 11-711-18-07..... | 40      |
| 11-711-19-07..... | 40      |
| 11-711-20-07..... | 40      |
| 11-712-15-07..... | 40      |
| 11-712-18-07..... | 40      |
| 11-712-19-07..... | 40      |
| 11-713-15-07..... | 40      |
| 11-713-18-07..... | 40      |
| 11-713-19-07..... | 40      |
| 11-713-20-07..... | 40      |
| 11-758-12-07..... | 41      |
| 11-760-09-07..... | 41      |
| 11-761-09-07..... | 41      |
| 11-865-12-07..... | 130     |
| 11-887-11-07..... | 99      |
| 11-887-18-07..... | 103     |
| 11-887-20-07..... | 103     |
| 11-887-23-07..... | 103     |
| 11-887-25-07..... | 103     |
| 11-887-30-07..... | 103     |
| 11-889-14-07..... | 115     |
| 11-889-18-07..... | 115     |
| 11-893-17-07..... | 124     |
| 11-895-16-07..... | 107     |
| 11-902-14-07..... | 84      |
| 11-903-14-07..... | 87      |
| 11-904-14-07..... | 85      |
| 11-905-14-07..... | 88      |
| 11-906-14-07..... | 86      |
| 11-907-14-07..... | 89      |
| 11-910-14-07..... | 91      |
| 11-910-17-07..... | 91      |
| 11-910-23-07..... | 91      |
| 11-911-14-07..... | 92      |
| 11-911-17-07..... | 92      |
| 11-911-23-07..... | 92      |
| 11-914-14-07..... | 131     |
| 11-914-18-07..... | 90, 131 |
| 11-914-20-07..... | 131     |
| 11-914-23-07..... | 131     |
| 11-914-25-07..... | 131     |
| 11-914-30-07..... | 131     |
| 11-915-14-07..... | 132     |
| 11-915-17-07..... | 132     |
| 11-915-23-07..... | 132     |
| 11-916-14-07..... | 133     |
| 11-916-18-07..... | 133     |
| 11-916-20-07..... | 133     |
| 11-917-11-07..... | 99      |
| 11-917-18-07..... | 103     |
| 11-917-20-07..... | 103     |
| 11-917-23-07..... | 103     |
| 11-917-25-07..... | 103     |
| 11-917-30-07..... | 103     |
| 11-919-14-07..... | 133     |
| 11-919-18-07..... | 133     |
| 11-921-17-07..... | 124     |
| 11-923-16-07..... | 107     |
| 11-930-15-07..... | 93      |
| 11-930-17-07..... | 93      |
| 11-931-15-07..... | 94      |
| 11-931-17-07..... | 94      |
| 11-934-12-07..... | 134     |
| 11-935-12-07..... | 134     |
| 11-936-11-07..... | 98      |
| 11-937-11-07..... | 99      |
| 11-938-14-07..... | 98      |
| 11-939-14-07..... | 99      |
| 11-942-18-07..... | 101     |
| 11-942-20-07..... | 101     |
| 11-942-23-07..... | 101     |
| 11-942-25-07..... | 101     |
| 11-942-28-07..... | 101     |
| 11-942-30-07..... | 101     |

|                   |     |
|-------------------|-----|
| 11-943-18-07..... | 102 |
| 11-943-20-07..... | 102 |
| 11-943-23-07..... | 102 |
| 11-943-25-07..... | 102 |
| 11-943-28-07..... | 102 |
| 11-943-30-07..... | 102 |
| 11-948-14-07..... | 119 |
| 11-949-14-07..... | 119 |
| 11-950-10-07..... | 134 |
| 11-950-16-07..... | 105 |
| 11-950-21-07..... | 105 |
| 11-951-10-07..... | 134 |
| 11-951-16-07..... | 106 |
| 11-951-21-07..... | 106 |
| 11-954-14-07..... | 114 |
| 11-955-14-07..... | 115 |
| 11-956-14-07..... | 116 |
| 11-957-14-07..... | 117 |
| 11-960-18-07..... | 114 |
| 11-961-18-07..... | 115 |
| 11-961-20-07..... | 115 |
| 11-961-23-07..... | 115 |
| 11-961-25-07..... | 115 |
| 11-961-28-07..... | 115 |
| 11-962-18-07..... | 116 |
| 11-962-20-07..... | 116 |
| 11-962-23-07..... | 116 |
| 11-965-14-07..... | 134 |
| 11-965-17-07..... | 124 |
| 11-967-18-07..... | 118 |
| 11-967-20-07..... | 118 |
| 11-967-23-07..... | 118 |
| 11-982-11-07..... | 126 |
| 11-983-11-07..... | 127 |
| 11-992-16-07..... | 96  |
| 11-993-16-07..... | 97  |
| 11-995-12-07..... | 130 |

## 12

|                   |     |
|-------------------|-----|
| 12-100-10-07..... | 136 |
| 12-100-11-07..... | 136 |
| 12-100-13-07..... | 136 |
| 12-100-14-07..... | 136 |
| 12-100-16-07..... | 136 |
| 12-100-18-07..... | 136 |
| 12-100-20-07..... | 136 |
| 12-100-23-07..... | 136 |
| 12-100-25-07..... | 136 |
| 12-100-30-07..... | 136 |
| 12-120-11-07..... | 136 |
| 12-120-13-07..... | 136 |
| 12-120-14-07..... | 136 |
| 12-120-16-07..... | 136 |
| 12-120-18-07..... | 136 |
| 12-120-20-07..... | 136 |
| 12-120-23-07..... | 136 |
| 12-120-25-07..... | 136 |
| 12-120-30-07..... | 136 |
| 12-122-13-07..... | 137 |
| 12-126-13-07..... | 137 |
| 12-126-14-07..... | 137 |
| 12-132-19-07..... | 137 |
| 12-134-20-07..... | 137 |
| 12-168-12-07..... | 137 |
| 12-168-15-07..... | 137 |
| 12-170-15-07..... | 137 |
| 12-172-12-07..... | 138 |
| 12-172-15-07..... | 138 |
| 12-186-18-07..... | 138 |
| 12-187-18-07..... | 138 |
| 12-192-18-07..... | 138 |
| 12-192-21-07..... | 138 |
| 12-192-25-07..... | 138 |
| 12-192-30-07..... | 138 |
| 12-238-15-07..... | 139 |
| 12-240-16-07..... | 139 |
| 12-240-18-07..... | 139 |
| 12-242-16-07..... | 139 |
| 12-242-18-07..... | 139 |
| 12-244-12-07..... | 140 |

|                   |     |                   |    |                   |     |                   |     |
|-------------------|-----|-------------------|----|-------------------|-----|-------------------|-----|
| 12-246-12-07..... | 140 | 12-774-21-07..... | 49 | 13-410-18-07..... | 159 | 15-091-18-07..... | 169 |
| 12-246-15-07..... | 140 | 12-776-15-07..... | 49 | 13-410-22-07..... | 159 | 15-095-10-07..... | 169 |
| 12-250-12-07..... | 140 | 12-776-18-07..... | 49 | 13-410-24-07..... | 159 | 15-095-17-07..... | 169 |
| 12-250-15-07..... | 140 | 12-776-21-07..... | 49 | 13-410-26-07..... | 159 | 15-095-20-07..... | 169 |
| 12-252-12-07..... | 140 | 12-786-15-09..... | 49 | 13-410-30-07..... | 159 | 15-095-22-07..... | 169 |
| 12-252-15-07..... | 140 | 12-786-18-09..... | 49 | 13-411-14-07..... | 160 | 15-100-01-07..... | 170 |
| 12-254-17-07..... | 141 | 12-786-21-09..... | 49 | 13-411-16-07..... | 160 | 15-100-02-07..... | 170 |
| 12-255-18-07..... | 141 | 12-787-15-09..... | 49 | 13-411-18-07..... | 160 | 15-100-03-07..... | 170 |
| 12-256-18-07..... | 141 | 12-787-18-09..... | 49 | 13-411-20-07..... | 160 | 15-100-04-07..... | 170 |
| 12-258-14-07..... | 141 | 12-787-21-09..... | 49 | 13-411-22-07..... | 160 | 15-101-01-07..... | 170 |
| 12-258-18-07..... | 141 |                   |    | 13-411-24-07..... | 160 | 15-101-02-07..... | 170 |
| 12-258-20-07..... | 141 |                   |    | 13-411-26-07..... | 160 | 15-101-03-07..... | 170 |
| 12-258-23-07..... | 141 |                   |    | 13-411-30-07..... | 160 | 15-101-04-07..... | 170 |
| 12-258-25-07..... | 141 |                   |    | 13-414-14-07..... | 161 | 15-161-01-07..... | 170 |
| 12-301-10-07..... | 142 |                   |    | 13-414-16-07..... | 161 | 15-161-02-07..... | 170 |
| 12-301-11-07..... | 142 |                   |    | 13-414-18-07..... | 161 | 15-171-08-07..... | 171 |
| 12-301-13-07..... | 142 |                   |    | 13-414-20-07..... | 161 | 15-171-10-07..... | 171 |
| 12-301-14-07..... | 142 |                   |    | 13-414-22-07..... | 161 | 15-171-12-07..... | 171 |
| 12-301-16-07..... | 142 |                   |    | 13-414-24-07..... | 161 | 15-171-14-07..... | 171 |
| 12-301-18-07..... | 142 |                   |    | 13-414-26-07..... | 161 | 15-171-16-07..... | 171 |
| 12-301-20-07..... | 142 |                   |    | 13-414-30-07..... | 161 | 15-171-18-07..... | 171 |
| 12-301-25-07..... | 142 |                   |    | 13-415-14-07..... | 162 | 15-172-08-07..... | 171 |
| 12-301-30-07..... | 142 |                   |    | 13-415-16-07..... | 162 | 15-172-10-07..... | 171 |
| 12-302-13-07..... | 142 |                   |    | 13-415-18-07..... | 162 | 15-172-12-07..... | 171 |
| 12-302-14-07..... | 142 |                   |    | 13-415-20-07..... | 162 | 15-172-14-07..... | 171 |
| 12-302-16-07..... | 142 |                   |    | 13-415-22-07..... | 162 | 15-172-16-07..... | 171 |
| 12-302-18-07..... | 142 |                   |    | 13-415-24-07..... | 162 | 15-172-18-07..... | 171 |
| 12-302-20-07..... | 142 |                   |    | 13-415-26-07..... | 162 | 15-220-01-07..... | 172 |
| 12-303-14-07..... | 143 |                   |    | 13-415-30-07..... | 162 | 15-220-02-07..... | 172 |
| 12-303-16-07..... | 143 |                   |    | 13-419-18-07..... | 163 | 15-220-03-07..... | 172 |
| 12-303-20-07..... | 143 |                   |    | 13-421-14-07..... | 163 | 15-220-04-07..... | 172 |
| 12-304-14-07..... | 143 |                   |    | 13-421-18-07..... | 163 | 15-220-06-07..... | 172 |
| 12-304-16-07..... | 143 |                   |    | 13-443-01-07..... | 164 | 15-221-01-07..... | 172 |
| 12-321-13-07..... | 143 |                   |    | 13-443-02-07..... | 164 | 15-221-02-07..... | 172 |
| 12-321-14-07..... | 143 |                   |    | 13-443-03-07..... | 164 | 15-221-03-07..... | 172 |
| 12-321-16-07..... | 143 |                   |    | 13-443-04-07..... | 164 | 15-221-04-07..... | 172 |
| 12-321-18-07..... | 143 |                   |    | 13-443-05-07..... | 164 | 15-221-06-07..... | 172 |
| 12-321-20-07..... | 143 |                   |    | 13-443-06-07..... | 164 | 15-222-01-07..... | 172 |
| 12-323-15-07..... | 143 |                   |    | 13-443-07-07..... | 164 | 15-222-02-07..... | 172 |
| 12-367-15-07..... | 144 |                   |    | 13-447-01-07..... | 164 | 15-222-03-07..... | 172 |
| 12-367-20-07..... | 144 |                   |    | 13-447-02-07..... | 164 | 15-222-04-07..... | 172 |
| 12-368-12-07..... | 144 |                   |    | 13-447-03-07..... | 164 | 15-222-06-07..... | 172 |
| 12-368-15-07..... | 144 |                   |    | 13-447-04-07..... | 164 | 15-293-01-07..... | 173 |
| 12-370-15-07..... | 144 |                   |    | 13-447-05-07..... | 164 | 15-293-02-07..... | 173 |
| 12-372-12-07..... | 144 |                   |    | 13-447-06-07..... | 164 | 15-293-03-07..... | 173 |
| 12-372-15-07..... | 144 |                   |    | 13-447-07-07..... | 164 | 15-293-04-07..... | 173 |
| 12-386-17-07..... | 144 |                   |    | 13-451-13-07..... | 165 | 15-293-05-07..... | 173 |
| 12-387-17-07..... | 144 |                   |    | 13-451-16-07..... | 165 | 15-301-16-07..... | 173 |
| 12-392-18-07..... | 145 |                   |    | 13-451-18-07..... | 165 | 15-301-25-07..... | 173 |
| 12-392-21-07..... | 145 |                   |    | 13-451-20-07..... | 165 | 15-317-01-07..... | 174 |
| 12-392-25-07..... | 145 |                   |    | 13-451-23-07..... | 165 | 15-317-02-07..... | 174 |
| 12-400-12-07..... | 145 |                   |    | 13-451-25-07..... | 165 | 15-317-03-07..... | 174 |
| 12-404-12-07..... | 145 |                   |    | 13-451-28-07..... | 165 | 15-317-04-07..... | 174 |
| 12-404-15-07..... | 145 |                   |    | 13-453-18-07..... | 165 | 15-317-05-07..... | 174 |
| 12-406-12-07..... | 145 |                   |    | 13-453-22-07..... | 165 | 15-317-06-07..... | 174 |
| 12-406-15-07..... | 145 |                   |    | 13-453-25-07..... | 165 | 15-317-07-07..... | 174 |
| 12-552-01-07..... | 46  |                   |    | 13-453-28-07..... | 165 | 15-317-08-07..... | 174 |
| 12-552-02-07..... | 46  |                   |    | 13-915-08-07..... | 166 | 15-317-09-07..... | 174 |
| 12-552-03-07..... | 46  |                   |    | 13-915-11-07..... | 166 | 15-655-00-01..... | 175 |
| 12-552-04-07..... | 46  |                   |    | 13-915-13-07..... | 166 | 15-655-01-01..... | 175 |
| 12-552-05-07..... | 46  |                   |    | 13-915-15-07..... | 166 | 15-655-02-01..... | 175 |
| 12-552-06-07..... | 46  |                   |    | 13-924-11-07..... | 166 | 15-655-03-01..... | 175 |
| 12-552-07-07..... | 46  |                   |    | 13-924-14-07..... | 166 | 15-700-05-07..... | 180 |
| 12-552-08-07..... | 46  |                   |    |                   |     | 15-702-07-07..... | 180 |
| 12-552-09-07..... | 46  |                   |    |                   |     | 15-703-07-07..... | 180 |
| 12-552-10-07..... | 46  |                   |    |                   |     | 15-704-07-07..... | 180 |
| 12-552-11-07..... | 46  |                   |    |                   |     | 15-714-07-07..... | 180 |
| 12-552-12-07..... | 46  |                   |    |                   |     | 15-714-10-07..... | 180 |
| 12-553-01-07..... | 46  |                   |    |                   |     | 15-715-07-07..... | 180 |
| 12-553-05-07..... | 46  |                   |    |                   |     | 15-715-10-07..... | 180 |
| 12-553-06-07..... | 46  |                   |    |                   |     | 15-717-10-07..... | 181 |
| 12-553-07-07..... | 46  |                   |    |                   |     | 15-723-10-07..... | 181 |
| 12-553-08-07..... | 46  |                   |    |                   |     | 15-723-20-07..... | 181 |
| 12-553-09-07..... | 46  |                   |    |                   |     | 15-725-14-07..... | 182 |
| 12-560-00-07..... | 47  |                   |    |                   |     | 15-727-14-07..... | 182 |
| 12-560-02-07..... | 47  |                   |    |                   |     | 15-732-20-07..... | 183 |
| 12-560-03-07..... | 47  |                   |    |                   |     | 15-733-21-07..... | 183 |
| 12-560-05-07..... | 47  |                   |    |                   |     | 15-733-22-07..... | 183 |
| 12-560-45-07..... | 47  |                   |    |                   |     | 15-734-20-07..... | 184 |
| 12-561-00-07..... | 47  |                   |    |                   |     | 15-734-24-07..... | 184 |
| 12-561-02-07..... | 47  |                   |    |                   |     |                   |     |
| 12-561-03-07..... | 47  |                   |    |                   |     |                   |     |
| 12-561-05-07..... | 47  |                   |    |                   |     |                   |     |
| 12-561-45-07..... | 47  |                   |    |                   |     |                   |     |
| 12-562-00-07..... | 47  |                   |    |                   |     |                   |     |
| 12-562-01-07..... | 47  |                   |    |                   |     |                   |     |
| 12-562-02-07..... | 47  |                   |    |                   |     |                   |     |
| 12-562-03-07..... | 47  |                   |    |                   |     |                   |     |
| 12-562-04-07..... | 47  |                   |    |                   |     |                   |     |
| 12-562-05-07..... | 47  |                   |    |                   |     |                   |     |
| 12-563-00-07..... | 47  |                   |    |                   |     |                   |     |
| 12-563-01-07..... | 47  |                   |    |                   |     |                   |     |
| 12-563-02-07..... | 47  |                   |    |                   |     |                   |     |
| 12-563-03-07..... | 47  |                   |    |                   |     |                   |     |
| 12-563-04-07..... | 47  |                   |    |                   |     |                   |     |
| 12-563-05-07..... | 47  |                   |    |                   |     |                   |     |
| 12-564-15-07..... | 48  |                   |    |                   |     |                   |     |
| 12-564-18-07..... | 48  |                   |    |                   |     |                   |     |
| 12-565-15-07..... | 48  |                   |    |                   |     |                   |     |
| 12-565-18-07..... | 48  |                   |    |                   |     |                   |     |
| 12-566-15-07..... | 48  |                   |    |                   |     |                   |     |
| 12-566-18-07..... | 48  |                   |    |                   |     |                   |     |
| 12-566-21-07..... | 48  |                   |    |                   |     |                   |     |
| 12-567-15-07..... | 48  |                   |    |                   |     |                   |     |
| 12-567-18-07..... | 48  |                   |    |                   |     |                   |     |
| 12-567-21-07..... | 48  |                   |    |                   |     |                   |     |
| 12-568-15-07..... | 48  |                   |    |                   |     |                   |     |
| 12-568-18-07..... | 48  |                   |    |                   |     |                   |     |
| 12-569-15-07..... | 48  |                   |    |                   |     |                   |     |
| 12-569-18-07..... | 48  |                   |    |                   |     |                   |     |
| 12-570-15-07..... | 48  |                   |    |                   |     |                   |     |
| 12-570-18-07..... | 48  |                   |    |                   |     |                   |     |
| 12-571-15-07..... | 48  |                   |    |                   |     |                   |     |
| 12-571-18-07..... | 48  |                   |    |                   |     |                   |     |
| 12-574-15-07..... | 49  |                   |    |                   |     |                   |     |
| 12-574-18-07..... | 49  |                   |    |                   |     |                   |     |
| 12-574-21-07..... | 49  |                   |    |                   |     |                   |     |
| 12-576-15-07..... | 49  |                   |    |                   |     |                   |     |
| 12-576-18-07..... | 49  |                   |    |                   |     |                   |     |
| 12-576-21-07..... | 49  |                   |    |                   |     |                   |     |
| 12-578-15-09..... | 48  |                   |    |                   |     |                   |     |
| 12-578-18-09..... | 48  |                   |    |                   |     |                   |     |
| 12-579-15-09..... | 48  |                   |    |                   |     |                   |     |
| 12-579-18-09..... | 48  |                   |    |                   |     |                   |     |
| 12-580-15-09..... | 48  |                   |    |                   |     |                   |     |
| 12-580-18-09..... | 48  |                   |    |                   |     |                   |     |
| 12-580-21-09..... | 48  |                   |    |                   |     |                   |     |
| 12-581-15-09..... | 48  |                   |    |                   |     |                   |     |
| 12-581-18-09..... | 48  |                   |    |                   |     |                   |     |
| 12-581-21-09..... | 48  |                   |    |                   |     |                   |     |
| 12-582-15-09..... | 48  |                   |    |                   |     |                   |     |
| 12-582-18-09..... | 48  |                   |    |                   |     |                   |     |
| 12-583-15-09..... | 48  |                   |    |                   |     |                   |     |
| 12-583-18-09..... | 48  |                   |    |                   |     |                   |     |
| 12-586-15-09..... | 49  |                   |    |                   |     |                   |     |
| 12-586-18-09..... | 49  |                   |    |                   |     |                   |     |
| 12-586-21-09..... | 49  |                   |    |                   |     |                   |     |
| 12-588-15-09..... | 49  |                   |    |                   |     |                   |     |
| 12-588-18-09..... | 49  |                   |    |                   |     |                   |     |
| 12-588-21-09..... | 49  |                   |    |                   |     |                   |     |
| 12-589-15-07..... | 49  |                   |    |                   |     |                   |     |
| 12-589-18-07..... | 49  |                   |    |                   |     |                   |     |
| 12-589-21-07..... | 49  |                   |    |                   |     |                   |     |
| 12-590-15-09..... | 49  |                   |    |                   |     |                   |     |
| 12-590-18-09..... | 49  |                   |    |                   |     |                   |     |
| 12-590-21-09..... | 49  |                   |    |                   |     |                   |     |
| 12-591-00-07..... | 49  |                   |    |                   |     |                   |     |
| 12-591-01-07..... | 49  |                   |    |                   |     |                   |     |
| 12-591-02-07..... | 49  |                   |    |                   |     |                   |     |
| 12-591-03-07..... | 49  |                   |    |                   |     |                   |     |
| 12-591-04-07..... | 49  |                   |    |                   |     |                   |     |
| 12-591-05-07..... | 49  |                   |    |                   |     |                   |     |
| 12-592-00-07..... | 49  |                   |    |                   |     |                   |     |
| 12-592-01-07..... | 49  |                   |    |                   |     |                   |     |
| 12-592-02-07..... | 49  |                   |    |                   |     |                   |     |
| 12-592-03-07..... | 49  |                   |    |                   |     |                   |     |
| 12-592-04-07..... | 49  |                   |    |                   |     |                   |     |
| 12-592-05-07..... | 49  |                   |    |                   |     |                   |     |
| 12-774-15-07..... | 49  |                   |    |                   |     |                   |     |
| 12-774-18-07..... | 49  |                   |    |                   |     |                   |     |
| 13-010-00-07..... | 150 |                   |    |                   |     |                   |     |
| 13-050-14-07..... | 150 |                   |    |                   |     |                   |     |
| 13-051-14-07..... | 150 |                   |    |                   |     |                   |     |
| 13-052-04-07..... | 150 |                   |    |                   |     |                   |     |
| 13-052-05-07..... | 150 |                   |    |                   |     |                   |     |
| 13-053-05-07..... | 150 |                   |    |                   |     |                   |     |
| 13-054-05-07..... | 151 |                   |    |                   |     |                   |     |
| 13-055-05-07..... | 151 |                   |    |                   |     |                   |     |
| 13-056-03-07..... | 151 |                   |    |                   |     |                   |     |
| 13-058-05-07..... | 151 |                   |    |                   |     |                   |     |
| 13-059-05-07..... | 151 |                   |    |                   |     |                   |     |
| 13-062-00-07..... | 152 |                   |    |                   |     |                   |     |
| 13-062-01-07..... | 152 |                   |    |                   |     |                   |     |
| 13-062-02-07..... | 152 |                   |    |                   |     |                   |     |



|                   |    |                   |     |                   |          |                   |     |
|-------------------|----|-------------------|-----|-------------------|----------|-------------------|-----|
| 20-012-23-07..... | 52 | 20-668-00-07..... | 251 | 23-135-30-04..... | 259      | 23-280-10-04..... | 272 |
| 20-013-15-07..... | 52 | 20-668-01-07..... | 251 | 23-136-02-07..... | 260      | 23-280-20-04..... | 272 |
| 20-013-18-07..... | 52 | 20-668-02-07..... | 251 | 23-136-03-07..... | 260      | 23-280-30-04..... | 272 |
| 20-013-21-07..... | 52 | 20-668-03-07..... | 251 | 23-136-04-07..... | 260      | 23-280-40-04..... | 272 |
| 20-013-23-07..... | 52 | 20-670-00-07..... | 251 | 23-136-06-07..... | 260      | 23-282-01-04..... | 272 |
| 20-016-15-09..... | 52 | 20-670-01-07..... | 251 | 23-136-08-07..... | 260      | 23-282-02-04..... | 272 |
| 20-016-18-09..... | 52 | 20-670-02-07..... | 251 | 23-136-10-07..... | 260      | 23-282-03-04..... | 272 |
| 20-017-15-09..... | 52 | 20-670-03-07..... | 251 | 23-136-12-07..... | 260      | 23-282-04-04..... | 272 |
| 20-017-18-09..... | 52 | 20-894-14-07..... | 147 | 23-136-15-07..... | 260      | 23-282-10-04..... | 272 |
| 20-018-15-09..... | 52 | <b>22</b>         |     | 23-136-53-07..... | 260      | 23-304-10-07..... | 273 |
| 20-018-18-09..... | 52 | 22-152-00-07..... | 254 | 23-136-54-07..... | 260      | 23-304-20-07..... | 273 |
| 20-019-15-09..... | 52 | 22-152-01-07..... | 254 | 23-136-56-07..... | 260      | 23-304-30-07..... | 273 |
| 20-019-18-09..... | 52 | 22-152-02-07..... | 254 | 23-136-58-07..... | 260      | 23-304-40-07..... | 273 |
| 20-020-15-09..... | 52 | 22-152-03-07..... | 254 | 23-136-60-07..... | 260      | 23-305-01-07..... | 273 |
| 20-020-18-09..... | 52 | 22-152-04-07..... | 254 | 23-136-62-07..... | 260      | 23-305-02-07..... | 273 |
| 20-020-21-09..... | 52 | 22-152-05-07..... | 254 | 23-136-65-07..... | 260      | 23-305-03-07..... | 273 |
| 20-020-23-09..... | 52 | 22-152-06-07..... | 254 | 23-138-04-07..... | 261      | 23-305-04-07..... | 273 |
| 20-021-15-09..... | 52 | 22-152-07-07..... | 254 | 23-138-06-07..... | 261      | 23-305-05-07..... | 273 |
| 20-021-18-09..... | 52 | 22-152-08-07..... | 254 | 23-138-08-07..... | 261      | 23-305-06-07..... | 273 |
| 20-021-21-09..... | 52 | 22-152-09-07..... | 254 | 23-138-10-07..... | 261      | 23-306-10-07..... | 273 |
| 20-021-23-09..... | 52 | <b>23</b>         |     | 23-138-13-07..... | 261      | 23-306-20-07..... | 273 |
| 20-022-15-09..... | 52 | 23-112-05-04..... | 255 | 23-138-15-07..... | 261      | 23-306-30-07..... | 273 |
| 20-022-18-09..... | 52 | 23-112-09-04..... | 255 | 23-138-18-07..... | 261      | 23-306-40-07..... | 273 |
| 20-022-21-09..... | 52 | 23-123-10-07..... | 255 | 23-138-20-07..... | 261      | 23-336-25-07..... | 274 |
| 20-022-23-09..... | 52 | 23-123-12-07..... | 255 | 23-138-25-07..... | 261      | 23-337-25-07..... | 274 |
| 20-023-15-09..... | 52 | 23-123-15-07..... | 255 | 23-138-30-07..... | 261      | 23-339-25-07..... | 274 |
| 20-023-18-09..... | 52 | 23-123-20-07..... | 255 | 23-138-38-07..... | 261      | 23-340-03-07..... | 274 |
| 20-023-21-09..... | 52 | 23-123-25-07..... | 255 | 23-138-44-07..... | 261      | 23-340-04-07..... | 274 |
| 20-023-23-09..... | 52 | 23-124-08-07..... | 255 | 23-138-50-07..... | 261      | 23-340-05-07..... | 274 |
| 20-030-15-07..... | 53 | 23-124-10-07..... | 255 | 23-139-04-07..... | 262      | 23-340-06-07..... | 274 |
| 20-030-18-07..... | 53 | 23-124-12-07..... | 255 | 23-139-06-07..... | 262      | 23-342-01-07..... | 275 |
| 20-030-18-09..... | 53 | 23-124-15-07..... | 255 | 23-139-08-07..... | 262      | 23-342-10-07..... | 275 |
| 20-030-21-07..... | 53 | 23-124-20-07..... | 255 | 23-139-10-07..... | 262      | 23-342-20-07..... | 275 |
| 20-030-21-09..... | 53 | 23-124-25-07..... | 255 | 23-139-13-07..... | 262      | 23-342-30-07..... | 275 |
| 20-030-23-07..... | 53 | 23-125-10-07..... | 256 | 23-139-15-07..... | 262      | 23-350-01-07..... | 275 |
| 20-030-23-09..... | 53 | 23-125-12-07..... | 256 | 23-139-18-07..... | 262      | 23-350-02-07..... | 275 |
| 20-031-15-07..... | 53 | 23-125-15-07..... | 256 | 23-139-20-07..... | 262      | 23-350-03-07..... | 275 |
| 20-031-15-09..... | 53 | 23-125-20-07..... | 256 | 23-139-25-07..... | 262      | 23-352-13-07..... | 276 |
| 20-031-18-07..... | 53 | 23-125-25-07..... | 256 | 23-139-30-07..... | 262      | 23-352-14-07..... | 276 |
| 20-031-18-09..... | 53 | 23-127-10-07..... | 256 | 23-139-38-07..... | 262      | 23-352-17-07..... | 276 |
| 20-031-21-07..... | 53 | 23-127-12-07..... | 256 | 23-139-44-07..... | 262      | 23-356-21-07..... | 276 |
| 20-031-23-07..... | 53 | 23-127-15-07..... | 256 | 23-139-50-07..... | 262      | 23-358-00-07..... | 276 |
| 20-031-23-09..... | 53 | 23-127-20-07..... | 256 | 23-154-06-07..... | 263      | 23-358-01-07..... | 276 |
| 20-032-15-07..... | 53 | 23-127-25-07..... | 256 | 23-154-09-07..... | 263      | 23-358-12-07..... | 276 |
| 20-032-18-07..... | 53 | 23-130-00-04..... | 257 | 23-154-13-07..... | 263      | 23-359-00-07..... | 277 |
| 20-032-18-09..... | 53 | 23-130-05-07..... | 257 | 23-154-16-07..... | 263      | 23-359-10-07..... | 277 |
| 20-032-21-07..... | 53 | 23-130-10-07..... | 257 | 23-154-19-07..... | 263      | 23-359-11-07..... | 277 |
| 20-032-21-09..... | 53 | 23-130-16-07..... | 257 | 23-154-25-07..... | 263      | 23-362-11-07..... | 277 |
| 20-032-23-07..... | 53 | 23-130-25-07..... | 257 | 23-155-06-07..... | 263      | 23-400-01-07..... | 280 |
| 20-032-23-09..... | 53 | 23-130-55-07..... | 257 | 23-155-09-07..... | 263      | 23-400-02-07..... | 280 |
| 20-033-15-07..... | 53 | 23-130-60-07..... | 257 | 23-155-13-07..... | 263      | 23-400-03-07..... | 280 |
| 20-033-15-09..... | 53 | 23-130-66-07..... | 257 | 23-155-16-07..... | 263      | 23-400-04-07..... | 280 |
| 20-033-18-07..... | 53 | 23-130-85-07..... | 257 | 23-155-19-07..... | 263      | 23-400-10-07..... | 280 |
| 20-033-18-09..... | 53 | 23-130-90-98..... | 257 | 23-155-25-07..... | 263      | 23-400-11-07..... | 280 |
| 20-033-21-07..... | 53 | 23-130-99-07..... | 257 | 23-160-01-04..... | 264      | 23-400-12-07..... | 280 |
| 20-033-21-09..... | 53 | 23-132-04-04..... | 258 | 23-160-02-04..... | 264      | 23-400-20-07..... | 281 |
| 20-033-23-07..... | 53 | 23-132-06-04..... | 258 | 23-160-03-04..... | 264      | 23-400-21-07..... | 281 |
| 20-033-23-09..... | 53 | 23-132-08-04..... | 258 | 23-160-04-04..... | 264      | 23-400-25-07..... | 281 |
| 20-048-18-07..... | 53 | 23-132-10-04..... | 258 | 23-162-03-07..... | 264      | 23-400-26-07..... | 281 |
| 20-049-18-07..... | 53 | 23-132-12-04..... | 258 | 23-162-05-07..... | 264      | 23-400-30-07..... | 281 |
| 20-050-18-07..... | 53 | 23-133-04-04..... | 258 | 23-162-06-07..... | 264      | 23-401-18-07..... | 282 |
| 20-051-18-07..... | 53 | 23-133-06-04..... | 258 | 23-162-08-07..... | 264      | 23-402-19-07..... | 282 |
| 20-298-10-07..... | 54 | 23-133-08-04..... | 258 | 23-162-09-07..... | 264      | 23-404-18-07..... | 282 |
| 20-298-11-07..... | 54 | 23-133-10-04..... | 258 | 23-197-03-04..... | 269      | 23-406-16-07..... | 283 |
| 20-299-10-07..... | 54 | 23-133-12-04..... | 258 | 23-197-05-04..... | 269      | 23-412-20-07..... | 283 |
| 20-299-11-07..... | 54 | 23-134-05-04..... | 259 | 23-197-08-04..... | 269      | 23-414-19-07..... | 283 |
| 20-300-11-07..... | 54 | 23-134-07-04..... | 259 | 23-199-12-04..... | 269      | 23-416-11-07..... | 284 |
| 20-300-13-07..... | 54 | 23-134-10-04..... | 259 | 23-199-14-04..... | 269      | 23-417-11-07..... | 284 |
| 20-300-14-07..... | 54 | 23-134-15-04..... | 259 | 23-199-16-04..... | 269      | 23-418-15-07..... | 284 |
| 20-301-13-07..... | 55 | 23-134-20-04..... | 259 | 23-215-19-07..... | 270      | 23-419-15-07..... | 284 |
| 20-302-01-07..... | 55 | 23-134-25-04..... | 259 | 23-240-29-04..... | 270, 271 | 23-423-01-07..... | 284 |
| 20-303-01-07..... | 55 | 23-135-05-04..... | 259 | 23-254-22-04..... | 270, 271 | 23-423-02-07..... | 284 |
| 20-303-09-07..... | 55 | 23-135-07-04..... | 259 | 23-256-00-04..... | 270, 271 | 23-423-03-07..... | 284 |
| 20-304-01-07..... | 55 | 23-135-10-04..... | 259 | 23-262-19-04..... | 271      | 23-423-04-07..... | 284 |
| 20-304-09-07..... | 55 | 23-135-15-04..... | 259 | 23-262-90-98..... | 271      | 23-423-05-07..... | 284 |
| 20-305-01-07..... | 55 | 23-135-20-04..... | 259 | 23-280-01-04..... | 272      | 23-423-06-07..... | 284 |
| 20-306-14-07..... | 56 | 23-135-25-04..... | 259 | 23-280-02-04..... | 272      | 23-423-07-07..... | 284 |
| 20-307-14-07..... | 56 |                   |     | 23-280-03-04..... | 272      | 23-425-06-07..... | 285 |
|                   |    |                   |     | 23-280-04-04..... | 272      | 23-425-10-07..... | 285 |
|                   |    |                   |     | 23-280-05-04..... | 272      | 23-425-13-07..... | 285 |

# Nummern-Index

Index of order numbers

Índice de números de referencia

Index numérique des références de commande

Elenco dei codici

|                      |                      |                            |                         |                             |
|----------------------|----------------------|----------------------------|-------------------------|-----------------------------|
| 23-425-19-07.....285 | 23-934-19-07.....307 | 24-390-20-07.....146       | 24-831-19-07.....64     | 24-849-10-04.....29         |
| 23-425-25-07.....285 | 23-934-22-07.....307 | 24-390-24-07.....146       | 24-835-13-07.....177    | 24-849-99-04.....24, 26, 29 |
| 23-426-06-07.....285 | 23-935-14-07.....308 | 24-390-30-07.....146       | 24-835-13-07.....64     | 24-850-01-07.....41         |
| 23-426-10-07.....285 | 23-935-17-07.....308 | 24-535-18-07.....220       | 24-835-18-07.....177    | 24-850-02-07.....41         |
| 23-426-13-07.....285 | 23-935-19-07.....308 | 24-535-21-07.....220       | 24-835-18-07.....64     | 24-850-03-07.....41         |
| 23-426-19-07.....285 | 23-935-22-07.....308 | 24-537-14-07.....64        | 24-843-01-07.....24, 25 | 24-850-04-07.....42         |
| 23-426-25-07.....285 | 23-941-15-07.....308 | 24-537-24-07.....64        | 24-843-02-07.....25     | 24-850-05-07.....42         |
| 23-428-06-04.....286 | 23-946-15-07.....308 | 24-600-30-07.....310       | 24-843-03-07.....25     | 24-850-10-07.....42         |
| 23-429-14-04.....286 | 23-950-18-07.....309 | 24-600-40-07.....310       | 24-843-04-07.....25     | 24-850-11-07.....42         |
| 23-432-14-04.....286 | 23-951-18-07.....309 | 24-600-50-07.....310       | 24-843-05-07.....25     | 24-850-15-07.....42         |
| 23-432-18-04.....286 | 23-955-23-07.....309 | 24-600-60-07.....310       | 24-843-06-07.....25     | 24-850-20-07.....43         |
| 23-433-03-04.....286 | 23-955-27-07.....309 | 24-600-70-07.....310       | 24-843-07-07.....25     | 24-850-21-07.....43         |
| 23-433-13-04.....286 | 23-997-01-07.....278 | 24-602-01-01.....310       | 24-843-08-07.....25     | 24-850-22-07.....43         |
| 23-433-18-04.....286 | 23-997-02-07.....278 | 24-618-33-07.....310       | 24-843-09-07.....25     | 24-850-23-07.....43         |
| 23-434-13-07.....287 | 23-997-03-07.....278 | 24-641-01-07.....215       | 24-843-10-07.....25     | 24-850-24-07.....43         |
| 23-436-04-07.....287 | 23-997-04-07.....278 | 24-641-02-07.....215       | 24-843-11-07.....25     | 24-850-25-07.....43         |
| 23-436-05-07.....287 | 23-997-10-07.....278 | 24-641-04-07.....215       | 24-843-12-07.....25     | 24-850-26-07.....43         |
| 23-436-07-07.....287 | 23-997-11-07.....278 | 24-641-05-07.....215       | 24-843-13-07.....25     | 24-850-28-07.....43         |
| 23-436-16-07.....287 | 23-997-12-07.....278 | 24-643-01-07.....215       | 24-843-14-07.....25     | 24-850-30-07.....43         |
| 23-437-20-04.....288 | 23-997-13-07.....278 | 24-643-10-07.....215       | 24-843-15-07.....25     | 24-850-31-07.....43         |
| 23-439-08-07.....288 | 23-997-20-07.....278 | 24-654-20-07.....310       | 24-843-16-07.....25     | 24-850-32-07.....43         |
| 23-461-05-07.....288 | 23-997-21-07.....278 | 24-658-21-07.....310       | 24-843-17-07.....25     | 24-850-33-07.....43         |
| 23-461-10-07.....288 | 23-997-22-07.....278 | 24-675-00-07.....311       | 24-843-18-07.....25     | 24-850-50-07.....44         |
| 23-461-15-07.....288 | 23-997-23-07.....278 | 24-676-00-07.....311       | 24-843-70-04.....24     | 24-850-60-07.....44         |
| 23-461-20-07.....288 | 23-997-30-07.....278 | 24-678-01-07.....311       | 24-844-01-07.....26, 27 | 24-851-10-07.....62         |
| 23-461-25-07.....288 | 23-997-31-07.....278 | 24-678-02-07.....311       | 24-844-02-07.....27     | 24-851-11-07.....62         |
| 23-484-17-07.....289 | 23-997-32-07.....278 | 24-680-25-07.....312       | 24-844-03-07.....27     | 24-851-12-07.....62         |
| 23-485-17-07.....289 | 23-997-33-07.....278 | 24-681-24-07.....312       | 24-844-04-07.....27     | 24-851-13-07.....62         |
| 23-486-17-07.....289 | 23-997-40-07.....278 | 24-682-18-07.....312       | 24-844-05-07.....27     | 24-852-01-07.....50         |
| 23-487-17-07.....289 | 23-997-41-07.....278 | 24-683-24-07.....313       | 24-844-06-07.....27     | 24-852-02-07.....50         |
| 23-495-20-07.....289 | 23-997-42-07.....278 | 24-684-19-07.....313       | 24-844-07-07.....27     | 24-852-10-07.....50         |
| 23-497-20-07.....289 | 23-997-43-07.....278 | 24-685-21-07.....313       | 24-844-08-07.....27     | 24-852-11-07.....50         |
| 23-499-01-07.....294 | 23-997-50-07.....278 | 24-686-21-07.....314       | 24-844-09-07.....27     | 24-852-12-07.....50         |
| 23-499-02-07.....294 | 23-997-51-07.....278 | 24-687-21-07.....314       | 24-844-10-07.....27     | 24-852-25-07.....50         |
| 23-499-03-07.....294 | 23-997-52-07.....278 | 24-688-22-07.....314       | 24-844-11-07.....27     | 24-852-26-07.....50         |
| 23-499-04-07.....294 | 23-997-53-07.....278 | 24-690-01-07.....315       | 24-844-12-07.....27     | 24-852-60-07.....50         |
| 23-510-17-07.....294 | 23-997-60-07.....278 | 24-690-02-07.....315       | 24-844-13-07.....27     | 24-852-61-07.....50         |
| 23-513-16-07.....294 | 23-997-61-07.....278 | 24-690-03-07.....315       | 24-844-14-07.....27     | 24-852-70-07.....50         |
| 23-516-18-07.....295 | 23-997-62-07.....278 | 24-690-04-07.....315       | 24-844-15-07.....27     | 24-852-71-07.....50         |
| 23-517-20-07.....295 | 23-997-63-07.....278 | 24-690-05-07.....315       | 24-844-16-07.....27     | 24-852-72-07.....50         |
| 23-523-16-07.....295 | 23-997-70-07.....278 | 24-691-24-07.....314       | 24-844-17-07.....27     | 24-852-73-07.....50         |
| 23-527-19-07.....295 | 23-997-71-07.....278 | 24-702-01-07.....216       | 24-844-18-07.....27     | 24-852-74-07.....50         |
| 23-777-01-07.....300 | 23-997-72-07.....278 | 24-702-02-07.....94, 216   | 24-844-19-07.....27     | 24-852-75-07.....50         |
| 23-777-02-07.....300 | 23-997-73-07.....278 | 24-702-03-07.....216, 217, | 24-844-20-07.....27     | 24-852-76-07.....50         |
| 23-801-14-07.....300 | 23-998-01-07.....279 | .....218, 219              | 24-844-21-07.....27     | 24-853-01-07.....65         |
| 23-815-16-07.....300 | 23-998-02-07.....279 | 24-702-04-07.....216, 217  | 24-844-22-07.....27     | 24-853-02-07.....65         |
| 23-819-18-07.....300 | 23-998-03-07.....279 | 24-702-05-07.....216, 217  | 24-844-23-07.....27     | 24-853-03-07.....65         |
| 23-826-18-07.....301 | 23-998-10-07.....279 | 24-702-06-07.....217       | 24-844-24-07.....27     | 24-854-01-07.....65         |
| 23-828-18-07.....301 | 23-998-11-07.....279 | 24-702-07-07.....217, 218, | 24-844-25-07.....27     | 24-854-02-07.....65         |
| 23-829-18-07.....301 | 23-998-12-07.....279 | .....220                   | 24-844-26-07.....27     | 24-854-03-07.....65         |
| 23-832-19-07.....301 | 23-998-20-07.....279 | 24-702-08-07.....216, 217, | 24-844-27-07.....27     | 24-854-04-07.....65         |
| 23-833-19-07.....301 | 23-998-21-07.....279 | .....218, 220              | 24-844-28-07.....26, 27 | 24-854-05-07.....65         |
| 23-835-15-07.....302 | 23-998-22-07.....279 | 24-702-11-07.....218       | 24-844-70-04.....26     | 24-854-06-07.....65         |
| 23-837-15-07.....302 | 23-998-30-07.....279 | 24-702-12-07.....218       | 24-844-80-07.....28     | 24-854-07-07.....65         |
| 23-846-17-07.....302 | 23-998-31-07.....279 | 24-702-13-07.....218, 219  | 24-844-81-07.....28     | 24-854-08-07.....65         |
| 23-847-17-07.....302 | 23-998-32-07.....279 | 24-702-14-07.....218, 219  | 24-844-82-07.....28     | 24-854-09-07.....65         |
| 23-853-15-07.....302 | 23-998-40-07.....279 | 24-702-15-07.....217,      | 24-844-83-07.....28     | 24-854-10-07.....65         |
| 23-864-15-07.....302 | 23-998-41-07.....279 | .....218, 219              | 24-844-84-07.....28     | 24-854-11-07.....65         |
| 23-865-15-07.....302 | 23-998-42-07.....279 | 24-702-16-07.....217,      | 24-844-85-07.....28     | 24-854-12-07.....65         |
| 23-876-15-07.....302 | 23-998-50-07.....279 | .....218, 219              | 24-844-86-07.....28     | 24-855-10-07.....31         |
| 23-877-15-07.....302 | 23-998-51-07.....279 | 24-720-08-01.....220       | 24-844-87-07.....28     | 24-856-01-07.....66         |
| 23-879-18-07.....303 | 23-998-52-07.....279 | 24-720-11-01.....220       | 24-848-00-04.....30     | 24-856-02-07.....66         |
| 23-881-18-07.....303 | <b>24</b>            | 24-720-14-01.....220       | 24-848-01-07.....30     | 24-856-03-07.....66         |
| 23-883-17-07.....303 | 24-384-16-07.....146 | 24-720-17-01.....220       | 24-848-02-07.....30     | 24-856-04-07.....66         |
| 23-885-20-07.....303 | 24-384-20-07.....146 | 24-721-14-01.....220       | 24-848-03-07.....30     | 24-856-05-07.....66         |
| 23-887-18-07.....303 | 24-384-24-07.....146 | 24-721-17-01.....220       | 24-848-04-07.....30     | 24-856-06-07.....66         |
| 23-893-23-07.....304 | 24-384-30-07.....146 | 24-721-20-01.....220       | 24-848-05-07.....30     | 24-857-00-07.....73         |
| 23-895-22-07.....304 | 24-386-16-07.....146 | 24-738-26-07.....176       | 24-848-06-07.....30     | 24-857-00-09.....73         |
| 23-897-23-07.....304 | 24-386-20-07.....146 | 24-740-26-07.....176       | 24-848-07-07.....30     | 24-857-01-07.....72         |
| 23-899-02-07.....305 | 24-386-24-07.....146 | 24-742-19-07.....176       | 24-848-08-07.....30     | 24-857-01-09.....72         |
| 23-899-03-07.....305 | 24-388-16-07.....146 | 24-742-28-07.....176       | 24-849-00-04.....29     | 24-857-02-07.....72         |
| 23-899-04-07.....305 | 24-388-20-07.....146 | 24-744-19-07.....176       | 24-849-01-04.....29     | 24-857-02-09.....72         |
| 23-901-23-07.....305 | 24-388-24-07.....146 | 24-744-28-07.....176       | 24-849-02-04.....29     | 24-857-03-07.....72         |
| 23-905-24-07.....306 | 24-388-30-07.....146 | 24-748-17-07.....176       | 24-849-03-04.....29     | 24-857-03-09.....72         |
| 23-907-24-07.....306 | 24-389-16-07.....147 | 24-748-21-07.....176       | 24-849-04-04.....29     | 24-857-04-07.....72         |
| 23-909-24-07.....306 | 24-389-20-07.....147 | 24-823-20-07.....177       | 24-849-05-04.....29     | 24-857-04-09.....72         |
| 23-910-22-07.....307 | 24-389-24-07.....147 | 24-824-20-07.....177       | 24-849-06-04.....29     | 24-857-05-07.....72         |
| 23-911-22-07.....307 | 24-389-30-07.....147 | 24-825-16-07.....177       | 24-849-07-04.....29     | 24-857-05-09.....72         |
| 23-934-14-07.....307 | 24-390-16-07.....146 | 24-827-18-07.....177       | 24-849-08-04.....29     | 24-857-06-07.....72         |
| 23-934-17-07.....307 |                      | 24-830-19-07.....64        | 24-849-09-04.....29     | 24-857-06-09.....72         |

## Nummern-Index

Index of order numbers

Índice de números de referencia

Index numérique des références de commande

Elenco dei codici

## Index

Index

Indice

Index

Indice



|                      |                    |                    |                    |                     |
|----------------------|--------------------|--------------------|--------------------|---------------------|
| 24-857-07-07.....72  | 24-978-05-14.....2 | 24-978-45-14.....2 | 24-978-90-14.....4 | 24-979-35-14.....5  |
| 24-857-07-09.....72  | 24-978-06-07.....2 | 24-978-46-07.....2 | 24-978-91-07.....4 | 24-979-36-07.....5  |
| 24-857-08-07.....72  | 24-978-06-14.....2 | 24-978-46-14.....2 | 24-978-91-14.....4 | 24-979-36-14.....5  |
| 24-857-08-09.....72  | 24-978-07-07.....2 | 24-978-47-07.....2 | 24-978-92-07.....4 | 24-979-37-07.....5  |
| 24-857-09-07.....72  | 24-978-07-14.....2 | 24-978-47-14.....2 | 24-978-92-14.....4 | 24-979-37-14.....5  |
| 24-857-09-09.....72  | 24-978-08-07.....2 | 24-978-48-07.....2 | 24-978-93-07.....4 | 24-979-38-07.....5  |
| 24-857-10-07.....72  | 24-978-08-14.....2 | 24-978-48-14.....2 | 24-978-93-14.....4 | 24-979-38-14.....5  |
| 24-857-10-09.....72  | 24-978-09-07.....2 | 24-978-50-07.....3 | 24-978-94-07.....4 | 24-979-39-07.....5  |
| 24-857-11-07.....72  | 24-978-09-14.....2 | 24-978-50-14.....3 | 24-978-94-14.....4 | 24-979-39-14.....5  |
| 24-857-11-09.....72  | 24-978-10-07.....2 | 24-978-51-07.....3 | 24-978-95-07.....4 | 24-979-40-07.....5  |
| 24-857-12-07.....72  | 24-978-10-14.....2 | 24-978-51-14.....3 | 24-978-95-14.....4 | 24-979-40-14.....5  |
| 24-857-12-09.....72  | 24-978-11-07.....2 | 24-978-52-07.....3 | 24-979-01-07.....5 | 24-979-41-07.....5  |
| 24-857-13-07.....72  | 24-978-11-14.....2 | 24-978-52-14.....3 | 24-979-01-14.....5 | 24-979-41-14.....5  |
| 24-857-13-09.....72  | 24-978-12-07.....2 | 24-978-53-07.....3 | 24-979-02-07.....5 | 24-979-42-07.....5  |
| 24-857-14-07.....72  | 24-978-12-14.....2 | 24-978-53-14.....3 | 24-979-02-14.....5 | 24-979-42-14.....5  |
| 24-857-14-09.....72  | 24-978-13-07.....2 | 24-978-54-07.....3 | 24-979-03-07.....5 | 24-979-43-07.....5  |
| 24-857-15-07.....72  | 24-978-13-14.....2 | 24-978-54-14.....3 | 24-979-03-14.....5 | 24-979-43-14.....5  |
| 24-857-15-09.....72  | 24-978-14-07.....2 | 24-978-55-07.....3 | 24-979-04-07.....5 | 24-979-44-07.....5  |
| 24-857-16-07.....72  | 24-978-14-14.....2 | 24-978-55-14.....3 | 24-979-04-14.....5 | 24-979-44-14.....5  |
| 24-857-16-09.....72  | 24-978-15-07.....2 | 24-978-56-07.....3 | 24-979-05-07.....5 | 24-979-45-07.....5  |
| 24-857-17-07.....72  | 24-978-15-14.....2 | 24-978-56-14.....3 | 24-979-05-14.....5 | 24-979-45-14.....5  |
| 24-857-17-09.....72  | 24-978-16-07.....2 | 24-978-57-07.....3 | 24-979-06-07.....5 | 24-979-46-07.....5  |
| 24-857-18-07.....72  | 24-978-16-14.....2 | 24-978-57-14.....3 | 24-979-06-14.....5 | 24-979-46-14.....5  |
| 24-857-18-09.....72  | 24-978-17-07.....2 | 24-978-58-07.....3 | 24-979-07-07.....5 | 24-979-47-07.....5  |
| 24-857-19-07.....72  | 24-978-17-14.....2 | 24-978-58-14.....3 | 24-979-07-14.....5 | 24-979-47-14.....5  |
| 24-857-19-09.....72  | 24-978-18-07.....2 | 24-978-59-07.....3 | 24-979-08-07.....5 | 24-979-48-07.....5  |
| 24-858-01-07.....67  | 24-978-18-14.....2 | 24-978-59-14.....3 | 24-979-08-14.....5 | 24-979-48-14.....5  |
| 24-858-10-07.....67  | 24-978-19-07.....2 | 24-978-60-07.....3 | 24-979-09-07.....5 | 24-980-21-07.....6  |
| 24-858-11-07.....67  | 24-978-19-14.....2 | 24-978-60-14.....3 | 24-979-09-14.....5 | 24-980-21-14.....6  |
| 24-858-12-07.....67  | 24-978-20-07.....2 | 24-978-61-07.....3 | 24-979-10-07.....5 | 24-980-22-07.....6  |
| 24-858-13-07.....67  | 24-978-20-14.....2 | 24-978-61-14.....3 | 24-979-10-14.....5 | 24-980-22-14.....6  |
| 24-858-20-07.....67  | 24-978-21-07.....2 | 24-978-62-07.....3 | 24-979-11-07.....5 | 24-980-23-07.....6  |
| 24-858-21-07.....67  | 24-978-21-14.....2 | 24-978-62-14.....3 | 24-979-11-14.....5 | 24-980-23-14.....6  |
| 24-858-30-07.....67  | 24-978-22-07.....2 | 24-978-63-07.....3 | 24-979-12-07.....5 | 24-980-24-07.....6  |
| 24-860-02-07.....67  | 24-978-22-14.....2 | 24-978-63-14.....3 | 24-979-12-14.....5 | 24-980-24-14.....6  |
| 24-860-03-07.....67  | 24-978-23-07.....2 | 24-978-64-07.....3 | 24-979-13-07.....5 | 24-980-25-07.....6  |
| 24-860-04-07.....67  | 24-978-23-14.....2 | 24-978-64-14.....3 | 24-979-13-14.....5 | 24-980-25-14.....6  |
| 24-862-01-07.....68  | 24-978-24-07.....2 | 24-978-65-07.....3 | 24-979-14-07.....5 | 24-980-30-07.....7  |
| 24-862-02-07.....68  | 24-978-24-14.....2 | 24-978-65-14.....3 | 24-979-14-14.....5 | 24-980-30-14.....7  |
| 24-862-03-07.....68  | 24-978-25-07.....2 | 24-978-66-07.....3 | 24-979-15-07.....5 | 24-980-31-07.....7  |
| 24-862-04-07.....68  | 24-978-25-14.....2 | 24-978-66-14.....3 | 24-979-15-14.....5 | 24-980-31-14.....7  |
| 24-862-05-07.....68  | 24-978-26-07.....2 | 24-978-67-07.....3 | 24-979-16-07.....5 | 24-980-32-07.....7  |
| 24-862-06-07.....68  | 24-978-26-14.....2 | 24-978-67-14.....3 | 24-979-16-14.....5 | 24-980-32-14.....7  |
| 24-862-07-07.....68  | 24-978-27-07.....2 | 24-978-68-07.....3 | 24-979-17-07.....5 | 24-980-33-07.....7  |
| 24-862-10-07.....68  | 24-978-27-14.....2 | 24-978-68-14.....3 | 24-979-17-14.....5 | 24-980-33-14.....7  |
| 24-862-11-07.....68  | 24-978-28-07.....2 | 24-978-69-07.....3 | 24-979-18-07.....5 | 24-980-34-07.....7  |
| 24-862-20-07.....68  | 24-978-28-14.....2 | 24-978-69-14.....3 | 24-979-18-14.....5 | 24-980-34-14.....7  |
| 24-863-01-07.....69  | 24-978-29-07.....2 | 24-978-70-07.....3 | 24-979-19-07.....5 | 24-980-35-07.....7  |
| 24-863-10-07.....69  | 24-978-29-14.....2 | 24-978-70-14.....3 | 24-979-19-14.....5 | 24-980-35-14.....7  |
| 24-863-11-07.....69  | 24-978-30-07.....2 | 24-978-71-07.....3 | 24-979-20-07.....5 | 24-980-36-07.....7  |
| 24-863-12-07.....69  | 24-978-30-14.....2 | 24-978-71-14.....3 | 24-979-20-14.....5 | 24-980-36-14.....7  |
| 24-863-13-07.....69  | 24-978-31-07.....2 | 24-978-72-07.....3 | 24-979-21-07.....5 | 24-980-37-07.....7  |
| 24-864-01-07.....70  | 24-978-31-14.....2 | 24-978-72-14.....3 | 24-979-21-14.....5 | 24-980-37-14.....7  |
| 24-864-02-07.....70  | 24-978-32-07.....2 | 24-978-73-07.....3 | 24-979-22-07.....5 | 24-980-38-07.....7  |
| 24-865-01-07.....70  | 24-978-32-14.....2 | 24-978-73-14.....3 | 24-979-22-14.....5 | 24-980-38-14.....7  |
| 24-865-10-07.....70  | 24-978-33-07.....2 | 24-978-74-07.....3 | 24-979-23-07.....5 | 24-980-39-07.....7  |
| 24-865-11-07.....70  | 24-978-33-14.....2 | 24-978-74-14.....3 | 24-979-23-14.....5 | 24-980-39-14.....7  |
| 24-866-01-07.....70  | 24-978-34-07.....2 | 24-978-75-07.....3 | 24-979-24-07.....5 | 24-980-40-07.....7  |
| 24-866-02-07.....70  | 24-978-34-14.....2 | 24-978-75-14.....3 | 24-979-24-14.....5 | 24-980-40-14.....7  |
| 24-940-01-07.....71  | 24-978-35-07.....2 | 24-978-76-07.....3 | 24-979-25-07.....5 | 24-980-41-07.....7  |
| 24-940-02-07.....71  | 24-978-35-14.....2 | 24-978-76-14.....3 | 24-979-25-14.....5 | 24-980-41-14.....7  |
| 24-940-03-07.....71  | 24-978-36-07.....2 | 24-978-77-07.....3 | 24-979-26-07.....5 | 24-980-42-07.....7  |
| 24-940-04-07.....71  | 24-978-36-14.....2 | 24-978-77-14.....3 | 24-979-26-14.....5 | 24-980-42-14.....7  |
| 24-942-05-07.....71  | 24-978-37-07.....2 | 24-978-78-07.....3 | 24-979-27-07.....5 | 24-980-43-07.....7  |
| 24-942-07-07.....71  | 24-978-37-14.....2 | 24-978-78-14.....3 | 24-979-27-14.....5 | 24-980-43-14.....7  |
| 24-942-09-07.....71  | 24-978-38-07.....2 | 24-978-79-07.....3 | 24-979-28-07.....5 | 24-980-44-07.....7  |
| 24-942-11-07.....71  | 24-978-38-14.....2 | 24-978-79-14.....3 | 24-979-28-14.....5 | 24-980-44-14.....7  |
| 24-973-16-07.....213 | 24-978-39-07.....2 | 24-978-80-07.....3 | 24-979-29-07.....5 | 24-980-50-07.....8  |
| 24-974-17-07.....214 | 24-978-39-14.....2 | 24-978-80-14.....3 | 24-979-29-14.....5 | 24-981-05-07.....12 |
| 24-975-17-07.....214 | 24-978-40-07.....2 | 24-978-81-07.....3 | 24-979-30-07.....5 | 24-981-05-14.....12 |
| 24-977-27-07.....214 | 24-978-40-14.....2 | 24-978-81-14.....3 | 24-979-30-14.....5 | 24-981-06-07.....12 |
| 24-978-01-07.....2   | 24-978-41-07.....2 | 24-978-82-07.....3 | 24-979-31-07.....5 | 24-981-06-14.....12 |
| 24-978-01-14.....2   | 24-978-41-14.....2 | 24-978-82-14.....3 | 24-979-31-14.....5 | 24-981-07-07.....12 |
| 24-978-02-07.....2   | 24-978-42-07.....2 | 24-978-83-07.....3 | 24-979-32-07.....5 | 24-981-07-14.....12 |
| 24-978-02-14.....2   | 24-978-42-14.....2 | 24-978-83-14.....3 | 24-979-32-14.....5 | 24-981-08-07.....12 |
| 24-978-03-07.....2   | 24-978-43-07.....2 | 24-978-84-07.....3 | 24-979-33-07.....5 | 24-981-08-14.....12 |
| 24-978-03-14.....2   | 24-978-43-14.....2 | 24-978-84-14.....3 | 24-979-33-14.....5 | 24-981-09-07.....12 |
| 24-978-04-07.....2   | 24-978-44-07.....2 | 24-978-85-07.....3 | 24-979-34-07.....5 | 24-981-09-14.....12 |
| 24-978-04-14.....2   | 24-978-44-14.....2 | 24-978-85-14.....3 | 24-979-34-14.....5 | 24-981-10-07.....12 |
| 24-978-05-07.....2   | 24-978-45-07.....2 | 24-978-90-07.....4 | 24-979-35-07.....5 | 24-981-10-14.....12 |

## Nummern-Index

Index of order numbers

Índice de números de referencia

Index numérique des références de commande

Elenco dei codici

|                   |    |
|-------------------|----|
| 24-981-11-07..... | 12 |
| 24-981-11-14..... | 12 |
| 24-981-12-07..... | 12 |
| 24-981-12-14..... | 12 |
| 24-981-13-07..... | 12 |
| 24-981-13-14..... | 12 |
| 24-981-14-07..... | 12 |
| 24-981-14-14..... | 12 |
| 24-981-15-07..... | 12 |
| 24-981-15-14..... | 12 |
| 24-981-16-07..... | 12 |
| 24-981-16-14..... | 12 |
| 24-981-25-07..... | 13 |
| 24-981-25-14..... | 13 |
| 24-981-26-07..... | 13 |
| 24-981-26-14..... | 13 |
| 24-981-27-07..... | 13 |
| 24-981-27-14..... | 13 |
| 24-981-28-07..... | 13 |
| 24-981-28-14..... | 13 |
| 24-981-29-07..... | 13 |
| 24-981-29-14..... | 13 |
| 24-981-30-07..... | 13 |
| 24-981-30-14..... | 13 |
| 24-981-31-07..... | 13 |
| 24-981-31-14..... | 13 |
| 24-981-32-07..... | 13 |
| 24-981-32-14..... | 13 |
| 24-981-33-07..... | 13 |
| 24-981-33-14..... | 13 |
| 24-981-34-07..... | 13 |
| 24-981-34-14..... | 13 |
| 24-981-35-07..... | 13 |
| 24-981-35-14..... | 13 |
| 24-981-36-07..... | 13 |
| 24-981-36-14..... | 13 |
| 24-981-45-07..... | 14 |
| 24-981-45-14..... | 14 |
| 24-981-46-07..... | 14 |
| 24-981-46-14..... | 14 |
| 24-981-47-07..... | 14 |
| 24-981-47-14..... | 14 |
| 24-981-48-07..... | 14 |
| 24-981-48-14..... | 14 |
| 24-981-49-07..... | 14 |
| 24-981-49-14..... | 14 |
| 24-981-50-07..... | 14 |
| 24-981-50-14..... | 14 |
| 24-981-51-07..... | 14 |
| 24-981-51-14..... | 14 |
| 24-981-52-07..... | 14 |
| 24-981-52-14..... | 14 |
| 24-981-53-07..... | 14 |
| 24-981-53-14..... | 14 |
| 24-981-54-07..... | 14 |
| 24-981-54-14..... | 14 |
| 24-981-55-07..... | 14 |
| 24-981-55-14..... | 14 |
| 24-981-56-07..... | 14 |
| 24-981-56-14..... | 14 |
| 24-981-65-07..... | 15 |
| 24-981-65-14..... | 15 |
| 24-981-66-07..... | 15 |
| 24-981-66-14..... | 15 |
| 24-981-67-07..... | 15 |
| 24-981-67-14..... | 15 |
| 24-981-68-07..... | 15 |
| 24-981-68-14..... | 15 |
| 24-981-75-07..... | 16 |
| 24-981-75-14..... | 16 |
| 24-981-76-07..... | 16 |
| 24-981-76-14..... | 16 |
| 24-981-77-07..... | 16 |
| 24-981-77-14..... | 16 |
| 24-981-78-07..... | 16 |
| 24-981-78-14..... | 16 |
| 24-981-80-07..... | 17 |
| 24-981-80-14..... | 17 |
| 24-981-81-07..... | 17 |
| 24-981-81-14..... | 17 |

|                   |    |
|-------------------|----|
| 24-981-82-07..... | 17 |
| 24-981-82-14..... | 17 |
| 24-981-83-07..... | 17 |
| 24-981-83-14..... | 17 |
| 24-981-84-07..... | 18 |
| 24-981-84-14..... | 18 |
| 24-981-85-07..... | 18 |
| 24-981-85-14..... | 18 |
| 24-981-86-07..... | 18 |
| 24-981-86-14..... | 18 |
| 24-981-87-07..... | 18 |
| 24-981-87-14..... | 18 |
| 24-981-91-07..... | 18 |
| 24-981-91-14..... | 18 |
| 24-981-92-07..... | 18 |
| 24-981-92-14..... | 18 |
| 24-981-93-07..... | 18 |
| 24-981-93-14..... | 18 |
| 24-982-10-07..... | 19 |
| 24-982-10-14..... | 19 |
| 24-982-11-07..... | 19 |
| 24-982-11-14..... | 19 |
| 24-982-12-07..... | 19 |
| 24-982-12-14..... | 19 |
| 24-982-13-07..... | 19 |
| 24-982-13-14..... | 19 |
| 24-996-25-07..... | 31 |
| 24-996-27-07..... | 32 |
| 24-996-50-07..... | 32 |
| 24-996-51-07..... | 32 |
| 24-998-08-07..... | 33 |
| 24-998-09-07..... | 33 |
| 24-998-10-07..... | 33 |
| 24-999-07-07..... | 33 |
| 24-999-09-07..... | 33 |
| 24-999-11-07..... | 33 |

## 28

|                   |     |
|-------------------|-----|
| 28-429-18-07..... | 88  |
| 28-466-14-07..... | 91  |
| 28-466-17-07..... | 91  |
| 28-467-14-07..... | 92  |
| 28-467-17-07..... | 92  |
| 28-468-16-07..... | 105 |
| 28-469-16-07..... | 106 |
| 28-471-17-07..... | 94  |
| 28-472-20-07..... | 101 |
| 28-472-23-07..... | 101 |
| 28-473-18-07..... | 118 |
| 28-473-20-07..... | 118 |
| 28-473-23-07..... | 118 |
| 28-474-16-07..... | 96  |
| 28-475-16-07..... | 97  |
| 28-477-18-07..... | 124 |

## 36

|                   |     |
|-------------------|-----|
| 36-391-14-07..... | 148 |
| 36-395-16-07..... | 148 |
| 36-395-20-07..... | 148 |
| 36-743-10-07..... | 275 |
| 36-743-20-07..... | 275 |
| 36-743-30-07..... | 275 |
| 36-743-40-07..... | 275 |
| 36-743-50-07..... | 275 |
| 36-859-75-07..... | 34  |
| 36-859-90-07..... | 34  |
| 36-861-45-07..... | 34  |
| 36-861-75-07..... | 34  |

## 37

|                   |     |
|-------------------|-----|
| 37-115-16-07..... | 148 |
| 37-115-20-07..... | 148 |
| 37-521-04-07..... | 296 |
| 37-521-05-07..... | 296 |
| 37-525-16-07..... | 296 |
| 37-531-16-07..... | 296 |
| 37-541-19-07..... | 296 |
| 37-543-19-07..... | 296 |
| 37-545-18-07..... | 296 |
| 37-546-18-07..... | 296 |

|                   |     |
|-------------------|-----|
| 37-547-20-07..... | 297 |
| 37-549-22-07..... | 297 |
| 37-550-19-07..... | 297 |
| 37-557-22-07..... | 297 |
| 37-559-23-07..... | 297 |
| 37-560-18-07..... | 297 |
| 37-562-22-07..... | 297 |
| 37-568-21-07..... | 298 |
| 37-572-19-07..... | 298 |
| 37-579-22-07..... | 298 |
| 37-581-22-07..... | 298 |
| 37-583-21-07..... | 299 |
| 37-584-21-07..... | 299 |
| 37-585-16-07..... | 299 |
| 37-593-16-07..... | 265 |
| 37-594-16-07..... | 265 |
| 37-595-15-07..... | 265 |
| 37-597-02-07..... | 265 |
| 37-597-04-07..... | 265 |
| 37-597-06-07..... | 265 |
| 37-597-08-07..... | 265 |
| 37-601-16-07..... | 265 |
| 37-605-16-07..... | 265 |
| 37-606-07-07..... | 266 |
| 37-606-09-07..... | 266 |
| 37-606-12-07..... | 266 |
| 37-607-06-07..... | 266 |
| 37-608-02-07..... | 266 |
| 37-608-04-07..... | 266 |
| 37-608-07-07..... | 266 |
| 37-608-09-07..... | 266 |
| 37-608-12-07..... | 266 |
| 37-609-06-07..... | 267 |
| 37-610-16-07..... | 267 |
| 37-612-16-07..... | 267 |
| 37-616-10-07..... | 268 |
| 37-616-12-07..... | 268 |
| 37-616-14-07..... | 268 |
| 37-620-03-07..... | 268 |
| 37-620-04-07..... | 268 |
| 37-622-03-07..... | 268 |
| 37-622-04-07..... | 268 |
| 37-622-07-07..... | 268 |
| 37-622-09-07..... | 268 |
| 37-622-12-07..... | 268 |
| 37-623-04-07..... | 268 |
| 37-623-05-07..... | 268 |
| 37-623-06-07..... | 268 |
| 37-623-07-07..... | 268 |
| 37-671-21-07..... | 290 |
| 37-673-21-07..... | 290 |
| 37-674-18-07..... | 290 |
| 37-676-18-07..... | 290 |
| 37-680-01-07..... | 291 |
| 37-680-02-07..... | 291 |
| 37-680-03-07..... | 291 |
| 37-680-04-07..... | 291 |
| 37-680-05-07..... | 291 |
| 37-680-06-07..... | 291 |
| 37-680-07-07..... | 291 |
| 37-680-08-07..... | 291 |
| 37-680-09-07..... | 291 |
| 37-680-10-07..... | 291 |
| 37-680-21-07..... | 290 |
| 37-681-01-07..... | 292 |
| 37-681-02-07..... | 292 |
| 37-681-03-07..... | 292 |
| 37-681-04-07..... | 292 |
| 37-681-05-07..... | 292 |
| 37-681-06-07..... | 292 |
| 37-681-07-07..... | 292 |
| 37-681-08-07..... | 292 |
| 37-681-09-07..... | 292 |
| 37-681-10-07..... | 292 |
| 37-681-11-07..... | 292 |
| 37-681-12-07..... | 292 |
| 37-681-13-07..... | 292 |
| 37-682-01-07..... | 293 |
| 37-682-02-07..... | 293 |
| 37-682-03-07..... | 293 |

|                   |     |
|-------------------|-----|
| 37-682-04-07..... | 293 |
| 37-682-05-07..... | 293 |
| 37-684-15-07..... | 178 |
| 37-686-16-07..... | 178 |
| 37-687-17-07..... | 178 |
| 37-702-15-07..... | 178 |
| 37-704-02-07..... | 179 |
| 37-704-05-07..... | 179 |
| 37-704-07-07..... | 179 |
| 37-704-10-07..... | 179 |
| 37-731-14-07..... | 148 |

## 55

|                   |    |
|-------------------|----|
| 55-803-10-04..... | 10 |
| 55-803-15-04..... | 11 |
| 55-803-20-04..... | 20 |
| 55-803-50-04..... | 73 |
| 55-997-01-04..... | 21 |









## KLS Martin Group

### **KLS Martin Australia Pty Ltd.**

Sydney · Australia  
Tel. +61 2 9439 5316  
australia@klsmartin.com

### **KLS Martin do Brasil Ltda.**

São Paulo · Brazil  
Tel. +55 11 3554 2299  
brazil@klsmartin.com

### **KLS Martin Medical (Shanghai) International Trading Co., Ltd**

Shanghai · China  
Tel. +86 21 5820 6251  
china@klsmartin.com

### **KLS Martin India Pvt Ltd.**

Chennai · India  
Tel. +91 44 66 442 300  
india@klsmartin.com

### **Martin Italia S.r.l.**

Milan · Italy  
Tel. +39 039 605 67 31  
italia@klsmartin.com

### **Nippon Martin K.K.**

Tokyo · Japan  
Tel. +81 3 3814 1431  
nippon@klsmartin.com

### **KLS Martin SE Asia Sdn. Bhd.**

Penang · Malaysia  
Tel. +604 506 2380  
malaysia@klsmartin.com

### **KLS Martin de México S.A. de C.V.**

Mexico City · Mexico  
Tel. +52 55 7572 0944  
mexico@klsmartin.com

### **Martin Nederland/Marned B.V.**

Huizen · Netherlands  
Tel. +31 35 523 45 38  
infonl@klsmartin.com

### **Gebrüder Martin GmbH & Co. KG**

Moscow · Russia  
Tel. +7 499 792 76 19  
russia@klsmartin.com

### **KLS Martin Taiwan Ltd.**

Taipei 106 · Taiwan  
Tel. +886 2 2325 3169  
taiwan@klsmartin.com

### **Gebrüder Martin GmbH & Co. KG**

Dubai · United Arab Emirates  
Tel. +971 4 454 16 55  
middleeast@klsmartin.com

### **KLS Martin UK Ltd.**

Reading · United Kingdom  
Tel. +44 118 467 1500  
uk@klsmartin.com

### **KLS Martin LP**

Jacksonville · Florida, USA  
Tel. +1 904 641 77 46  
usa@klsmartin.com

### **Gebrüder Martin GmbH & Co. KG**

#### **A company of the KLS Martin Group**

KLS Martin Platz 1 · 78532 Tuttlingen · Germany  
P.O. Box 60 · 78501 Tuttlingen · Germany  
Tel. +49 7461 706-0 · Fax +49 7461 706-193  
info@klsmartin.com · www.klsmartin.com