

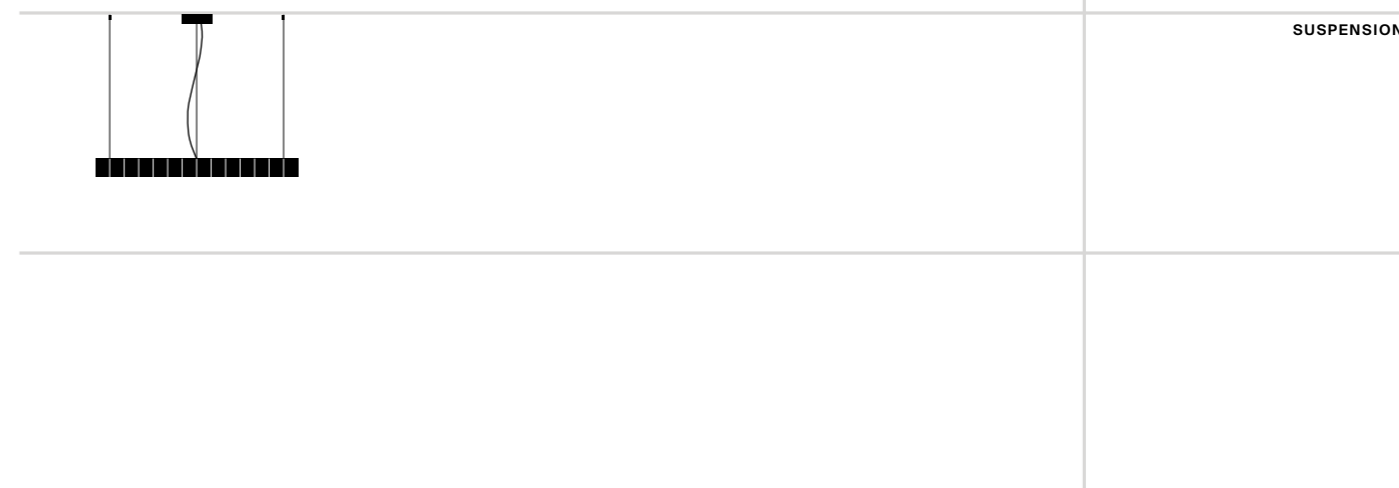

Honeycomb



SUSPENSION

Habits Studio, 2010

EN Like the cells of a beehive, the hexagonal modules of Honeycomb are freely grouped in a suspension lamp of captivating organic symmetry. The hexagons, connected by clips, form a self-supporting structure to contain LED sources for direct lighting.

IT Come le celle di un alveare, i moduli esagonali di Honeycomb si aggregano in una lampada a sospensione dall'affascinante simmetria organica. Gli esagoni, agganciati tra loro da piccole forcelle, danno vita a una struttura autoportante in grado di alloggiare sorgenti LED per luce diretta.

DE Die sechseckigen Module von Honeycomb, lassen sich wie die Zellen einer Bienenwabe beliebig zu einer Hangelampe mit faszinierender organischer Symmetrie aneinanderreihen. Die Sechsecke sind mit kleinen Kunststoffklammern untereinander befestigt, so dass eine selbsttragende Struktur entsteht, die für LED - Lichtquelle geeignet ist für direktes Licht.

FR Comme les alvéoles d'une ruche, les modules hexagonaux de Honeycomb s'assemblent librement pour former une lampe à suspension dotée d'une symétrie organique fascinante. Les hexagones, accrochés entre eux par le biais de petites fourches en plastique, créent une structure autoportante abritant des sources LED pour lumière directe.

ES Al igual que las celdas de una colmena, los módulos hexagonales de Honeycomb se van añadiendo libremente a una lámpara de suspensión con una fascinante simetría orgánica. Los hexágonos, enganchados entre sí por pequeñas horquillas de plástico, crean una estructura autoportante que puede albergar fuentes LED para iluminación directa.

D70

Honeycomb

D70C/1
weight 0,55 kg
D70C/3
weight 1,65 kg

D70C/1

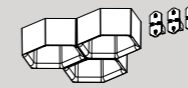

D70C/3

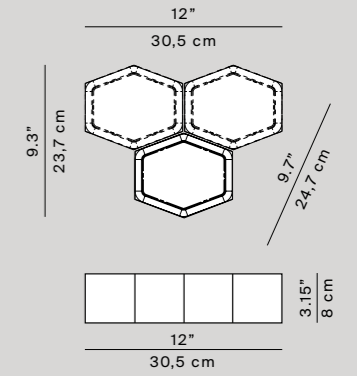
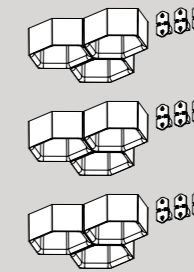

D70L/1N1
dimnable trailing edge
with wall control
structure 3 modukes
weight 1,14 kg

D70L/1N1



D70L/2N1

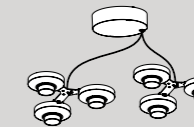

D70L/2N1
dimnable trailing edge
with wall control
structure 6 modukes
weight 1,73 kg

ceiling rose Ø 15 x 5 cm

Accessories

D70S
suspension kit

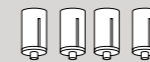

D70A
kit 5 hooks



Light source

D70L/1N1

LED module 25W* 3000K dimmable

D70L/2N1

LED module 50W* 3000K dimmable

Materials

Structure in polycarbonate, metal ceiling rose

Structure finishes

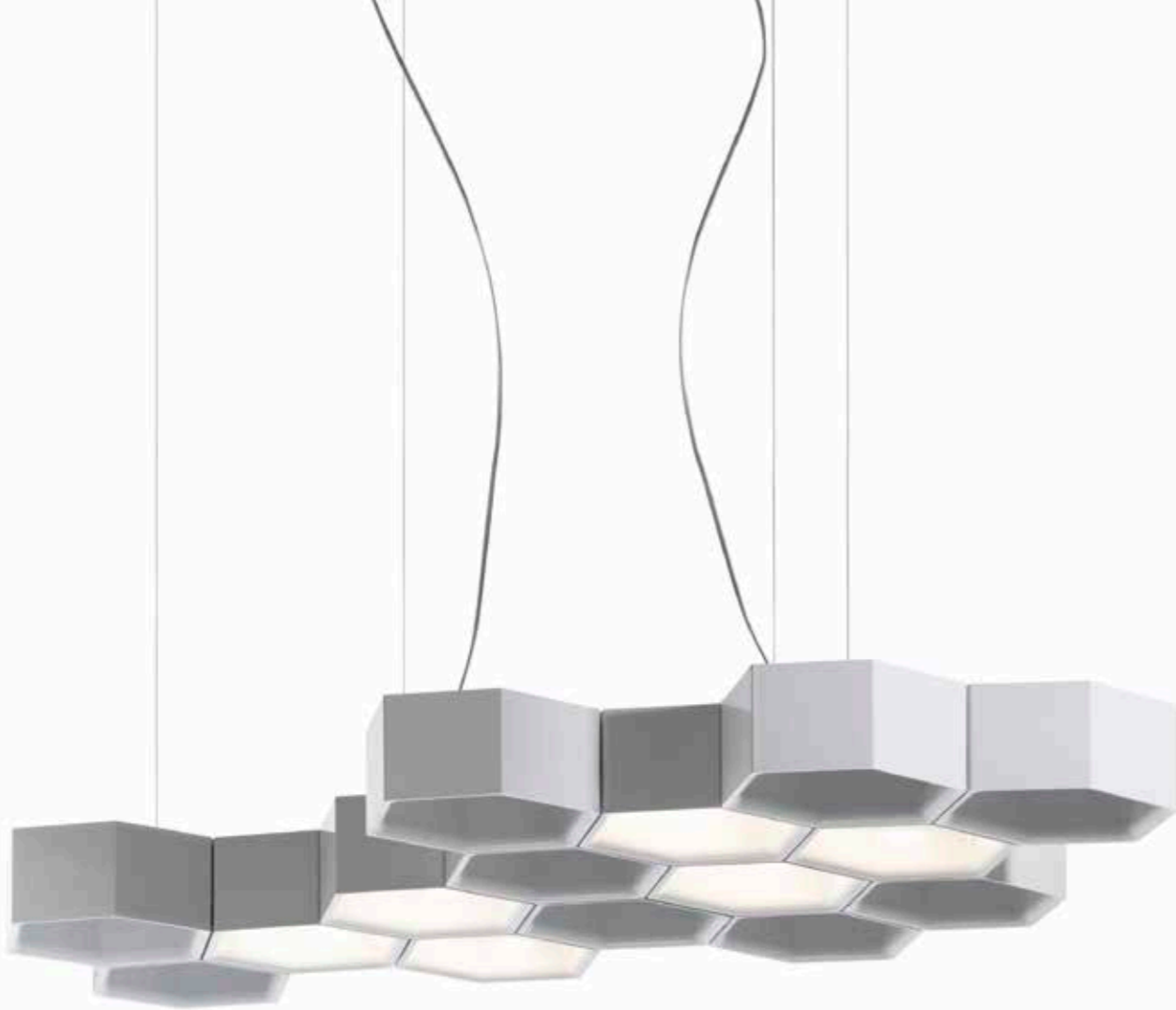

TECHNICAL DATA

MOD. Honeycomb

LUCEPLAN 2021/22

MOD. Honeycomb

LUCEPLAN 2021/22

* Power consumption by device

Suggested configurations

How to make a composition with 3 bodies and 1 light module

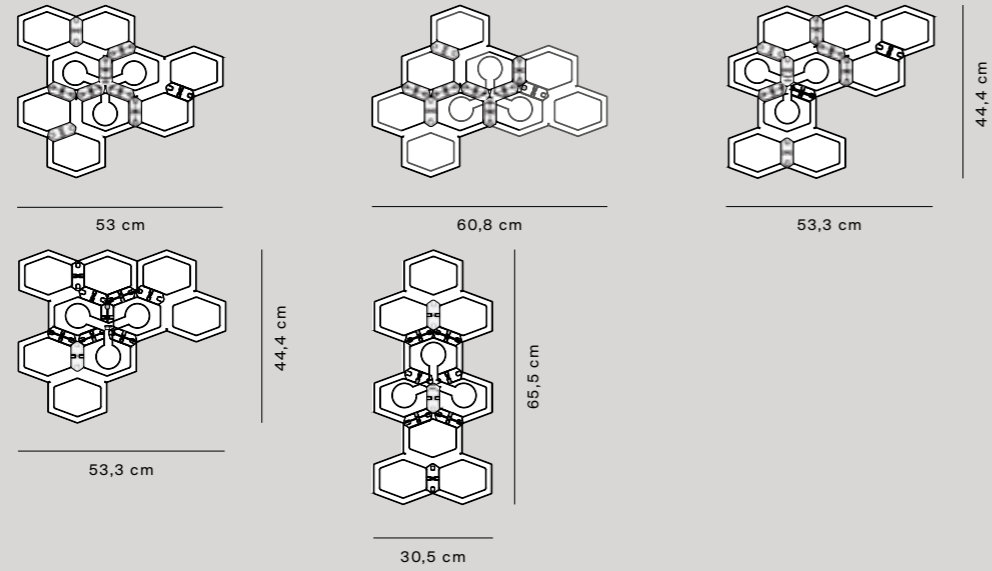

Q.ty	Description	Model	Item code
1	3 bodies + 9 attachments	D70C/3	1D7003000002
1	suspension kit	D70S	1D7002000002
1	+ optic, LED version	D70L/1N1	1D701L100000

How to make a composition with 3 bodies and 2 light modules

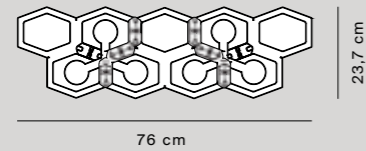

Q.ty	Description	Model	Item code
1	3 bodies + 9 attachments	D70C/3	1D7003000002
1	suspension kit	D70S	1D7002000002
1	+ 2 optics, LED version	D70L/2N1	1D701L200000

How to make a composition with 4 bodies and 1 light module

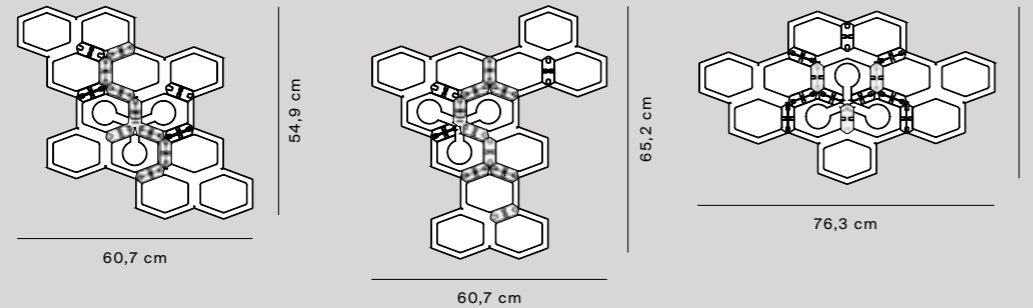

Q.ty	Description	Model	Item code
1	3 bodies + 9 attachments	D70C/3	1D7003000002
1	1 body + 3 attachments	D70C/1	1D7001000002
1	suspension kit	D70S	1D7002000002
1	+ optic, LED version	D70L/1N1	1D701L100000

Suggested configurations

How to make a composition with 4 bodies and 2 light modules

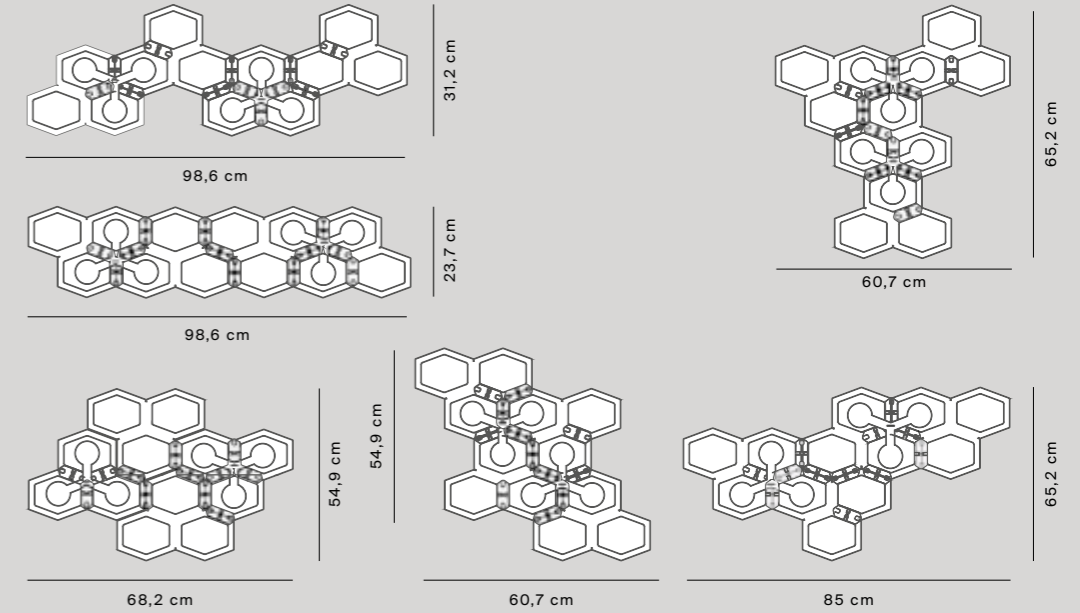

Q.ty	Description	Model	Item code
1	3 bodies + 9 attachments	D70C/3	1D7003000002
1	1 body + 3 attachments	D70C/1	1D7001000002
1	suspension kit	D70S	1D7002000002
1	+ 2 optics, LED version	D70L/2N1	1D701L200000

How to make a composition with 6 bodies and 2 light modules

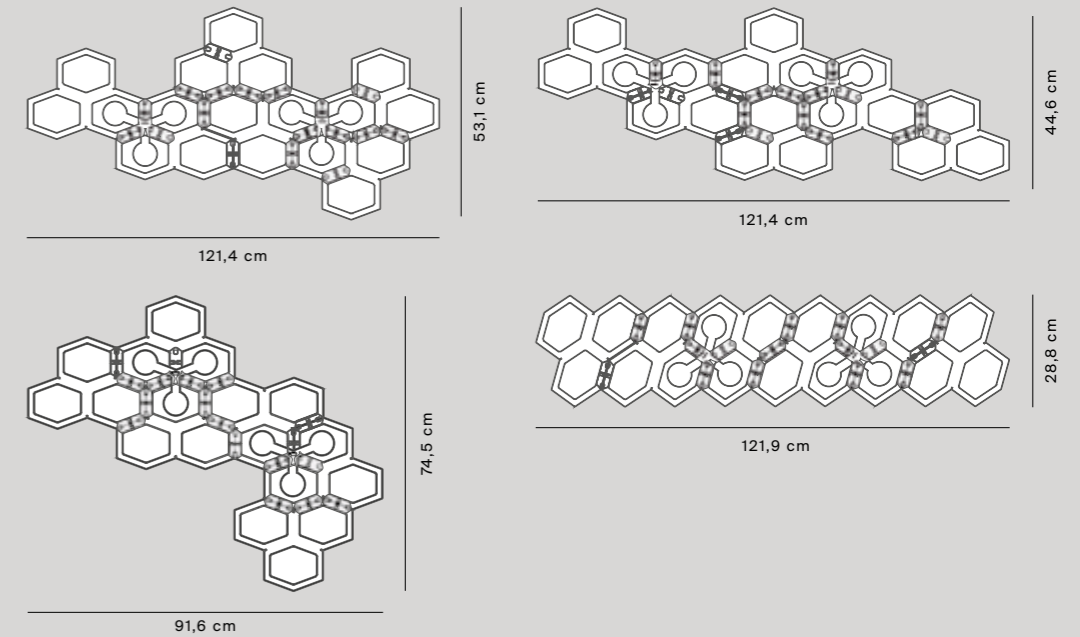

Q.ty	Description	Model	Item code
2	3 bodies + 9 attachments	D70C/3	1D7003000002
1	suspension kit	D70S	1D7002000002
1	+ 2 optics, LED version	D70L/2N1	1D701L200000