



# Reliable series-produced components

**Demag wheel range**

**DEMAG** .....

# Demag wheel systems

## Reliable solutions for every application

### CONTENTS

### PAGE

|                               |    |
|-------------------------------|----|
| Demag DRS wheel block system  | 6  |
| Demag LRS travel wheel system | 14 |
| Demag RS wheel block system   | 16 |
| Demag DWS wheel set           | 18 |

We have been designing and manufacturing modular wheel systems for a wide variety of applications for decades. Our broad range covers wheel loads up to 60 t and offers:

- Simple selection
- Many possible combinations
- Compact dimensions
- Versatile connection to the customer's design
- Design support by means of CAD files
- Simple assembly and alignment

Demag wheel systems are integral components of countless drive solutions that are in operation every day, offering high reliability and a long service life with a minimum maintenance requirement.

### COMPLETE TRAVEL UNITS

Complete travel units provide decisive advantages for drive applications. All components are perfectly matched and pre-assembled ready for fitting – from the travel wheel, housing and connecting arrangement to the gearbox, motor and frequency inverters for electronically controlled travel motions. Complete travel units give you the certainty of solid planning and a reliable investment.

### SOLUTIONS FOR SPECIFIC INDUSTRIES

There is hardly a manufacturing industry in which raw materials, semi-finished products and finished products do not have to be transported, merged, transferred, distributed or assembled. In many applications, special operating conditions and function requirements have to be taken into consideration. Demag wheel systems can meet the demands of any application, making them the first choice for any materials handling situation. If required, wheel blocks can be protected, for example, by special design measures against aggressive media. Or they can be fitted with electronically controlled drives, which enable them to accelerate even more quickly,





travel at uniform speeds and position with precision. Demag wheel systems ensure that floor-level travel units and systems can also negotiate tight curves with radii down to 10 m. Demag wheel systems also operate just as well indoors as outdoors.

#### COMPREHENSIVE APPLICATION EXPERTISE

With the extensive expertise gained from Demag wheel block applications in installations and systems we have built all over the world, we provide our customers with

help and advice for their applications. We offer state-of-the-art selection and design tools as well as calculation programs and project engineering support for the given application requirements.

#### ALL OVER THE WORLD

Wherever your Demag products are used, our many agencies and more than 220 service centres can guarantee a reliable supply of spare parts and provide expert repairs.



# For standardised and specific applications

## Demag wheel systems: Always the right wheel



**DRS**

### DRS WHEEL BLOCK SYSTEM

This versatile system provides optimum performance ratios for a maximum load capacity (from 2.75 to 40 t) with compact dimensions. Finely graded sizes (DRS 112 to DRS 500) ensure that the right unit is selected for the corresponding application.

Besides a wide variety of travel wheel types from our standard range, special designs are also available to meet customer requirements. The housing, which is machined on all sides, can be connected to virtually any customer design. Offset and angular geared motors from our Demag modular system are available for the driven variant as individual or central drive units.

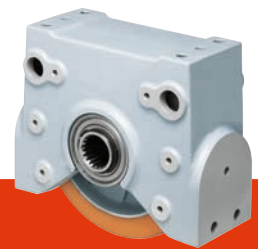

**LRS**

### LRS TRAVEL WHEEL SYSTEM:

A robust, universal travel wheel system for the lower load range up to 6.5 t. Simple project engineering makes it the ideal component for engineers who want to build their own solution for a wide variety of travel applications.

Two standard designs for each size – travel wheel with Hydropur tyre and a spheroidal-graphite cast-iron travel wheel with two flanges – are available pre-assembled from stock and can be supplied in a minimum of time. Standard offset geared motors can be assigned using selection tables for driven solutions.

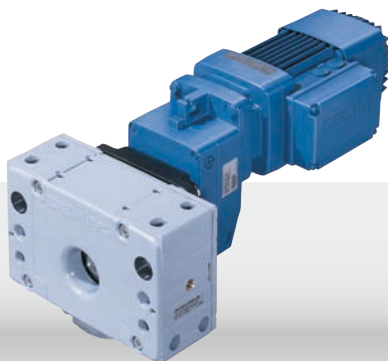

39384-1

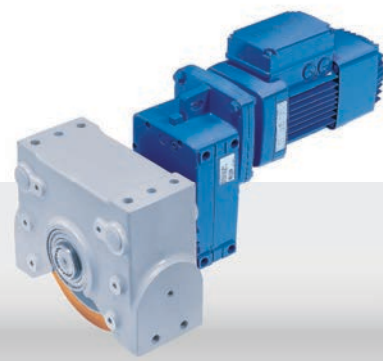

39227

Demag travel components are of modular design to match perfectly from start to finish, enabling fast and cost-effective standardised and tailored modular solutions to be implemented to meet your individual requirements. Every component used is developed, designed and tested by our specialists for unbeatable operating reliability, continuously optimised and manufactured in large series of first-class quality and with maximum precision.

## RS



### RS WHEEL BLOCK SYSTEM:

The system is suitable for special applications in which a stainless steel design or a housing made of sheet steel is required, as well as for high-temperature applications (up to 250 °C).

Various (RS 125 to RS 400) sizes can be supplied with load capacities from 3.5 to 18 t.

Various travel wheel designs and means of connection to customer structures also make this standard component suitable for universal applications. Demag offset geared motors can be used as drive units.

## DWS



### DWS WHEEL SET

This wheel set is the right choice for high load capacity applications. Sizes can be supplied with travel wheel diameters of 400, 500 and 630 mm with load capacities from 28 to 60 t.

DWS wheel sets are suitable for integration into hollow-profile sections or for corner-bearing arrangements. They can be supplied as driven or non-driven units, with Demag offset or angular geared motors being used as the drive.

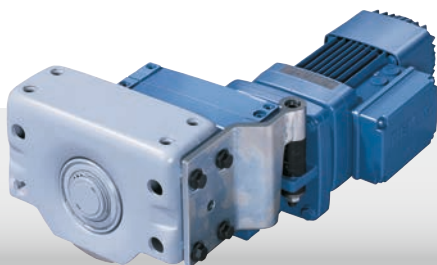

39383-1

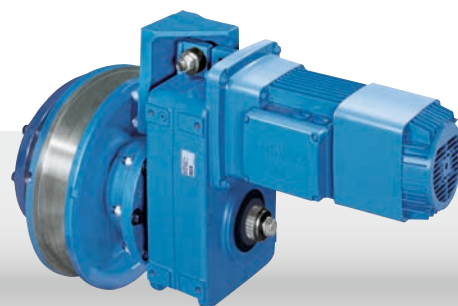

39398-2

# Versatility & high performance

## Demag DRS wheel block system

The Demag DRS wheel block system offers outstanding benefits from project engineering to commissioning of your installation. Wheel blocks are excellent solutions for a wide variety of applications. They also provide particularly high performance, i.e. maximum load capacity with reference to the travel wheel diameter.

### SIMPLE WHEEL REPLACEMENT

- Patented asymmetrical housing eliminates the need for removal and realignment of top-mounted units when travel wheels have to be replaced
  - The housing remains connected to the installation.
  - This job can be completed using conventional tools.
- Wheel blocks can be converted quickly and easily at a later date and equipped with travel wheels of a different design or material.

### WHEEL VARIANTS

- Wheels are available in various shapes and designs, such as:
  - Spheroidal-graphite cast iron
  - Polyamide
  - Hydropur tyres

### PROTECTED TRAVEL WHEELS

- The housing, enclosed on five sides, protects the travel wheels from any external mechanical influences
- Housing made of high-quality, corrosion-resistant, die-cast aluminium with a powder coating up to 90 µm thick for DRS sizes 112 to 200
- High-strength spheroidal-graphite cast iron with a RAL 7001 finishing coat from size DRS 250.
- Any housing openings that are not required can be closed with plugs included in the delivery

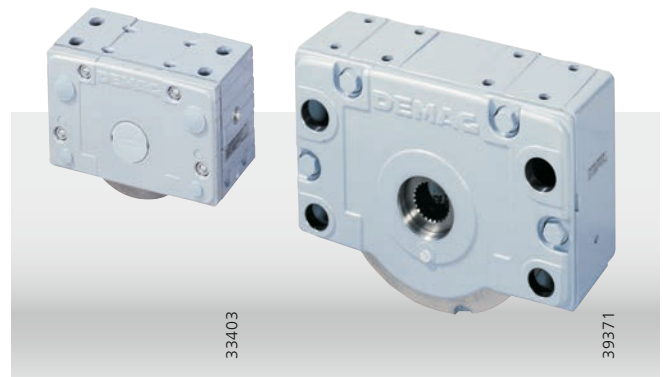
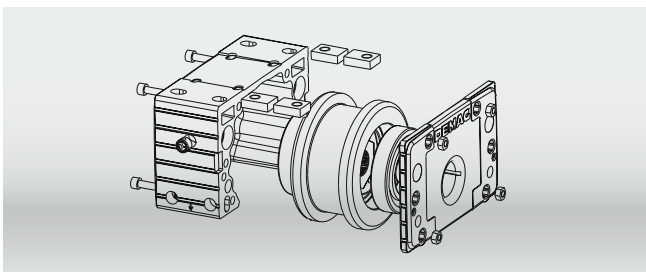



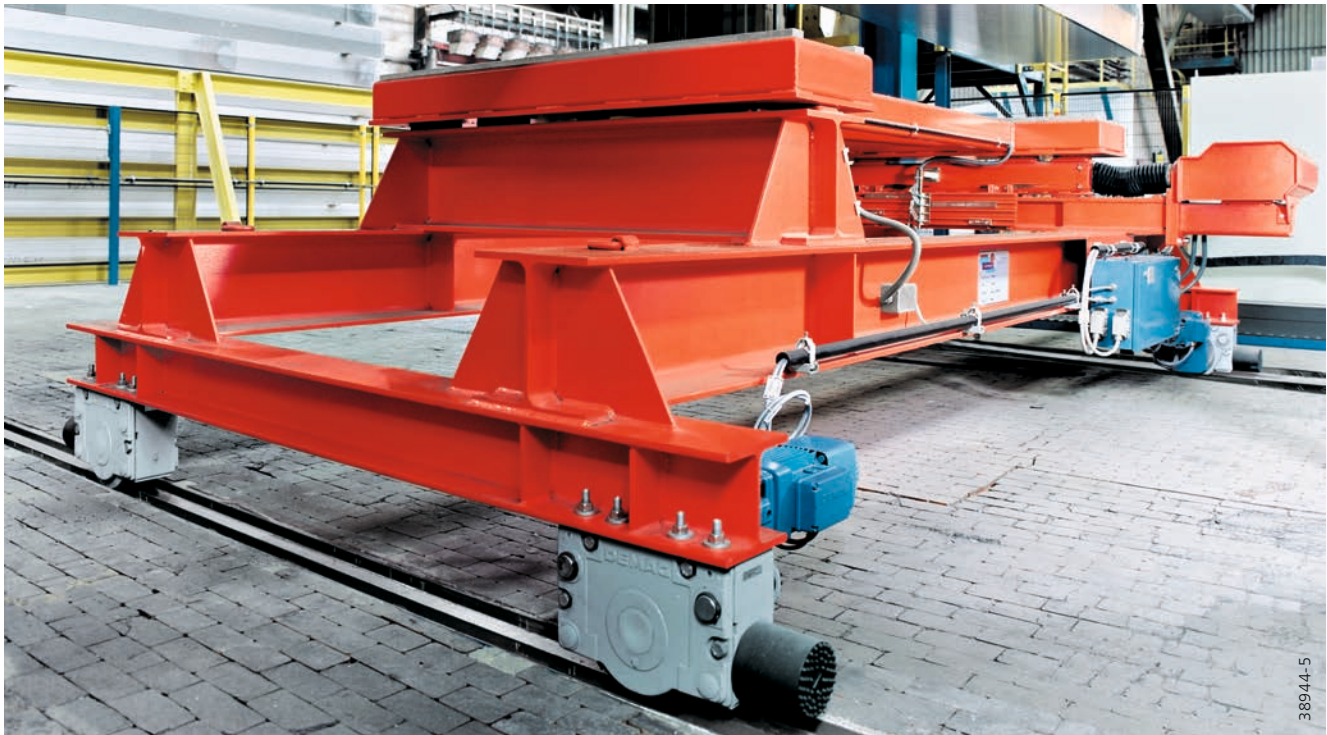

38944-5

#### EASY TO INSTALL AND RIGID DESIGN

- Designed for simple connection to superstructures with starting and braking characteristics that are gentle on the runway
- Tight housing design and position tolerances
- Accurate dimensions in all planes
- Special stiffeners for high rigidity.

#### PRECISE ALIGNMENT

- Laser system for simple alignment of wheel blocks
- Prepared brackets on the housing of all sizes from DRS 112 to DRS 500 enable wheel blocks to be aligned with each other quickly and precisely on multiple trolleys

#### LOW-MAINTENANCE BEARINGS

- Generously dimensioned grooved ball bearings which are lubricated for life, tapered roller bearings from size DRS 250
- Optimum mechanical protection thanks to bearings arranged inside the housing

#### HIGH GROUND CLEARANCE

- High ground clearance thanks to compact design
- Complete drive units with gearbox concept designed to match the wheel load

#### PATENTED SOLUTIONS

- Many design solutions, including patented features
  - Torque bracket
  - Travel wheel bearings
  - Travel wheel hub connection
  - Sliding nuts in the top connection (DRS 112 to DRS 200)

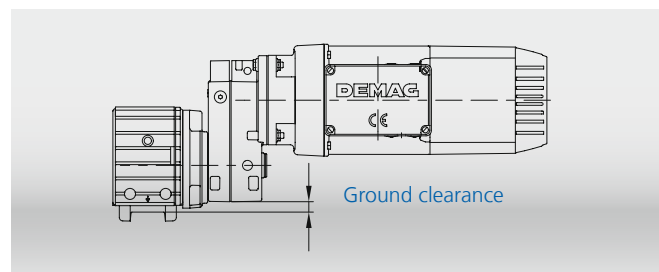
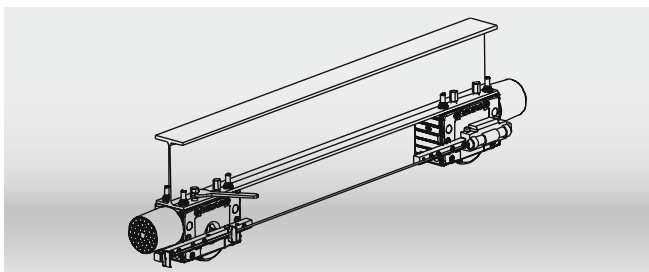

# Modular system for tailor-made solutions

The Demag DRS wheel block system with its wide variety of perfectly matched components can meet all your requirements. Demag DRS wheel blocks can be matched to many different types of travel rail and operating conditions with travel wheels from a wide range of standard designs or with specially developed travel wheel shapes – as cost-effective units ready for installation.

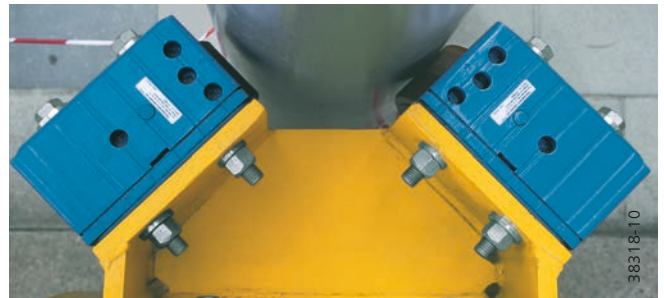

## TRAVEL WHEEL VARIANTS AND MATERIALS

With effective vibration-damping characteristics, the spheroidal-graphite cast-iron (GGG 70) travel wheels guarantee high-speed operation which is particularly gentle on the rail. The self-lubricating effect of the wheel material reduces friction and provides high resistance to wear. These properties make spheroidal-graphite cast-iron travel wheels far superior to conventional steel travel wheels.

Also available are polyamide travel wheels without flanges, which offer particularly smooth and quiet running properties and are gentle on the runway. Flangeless travel wheels fitted with Hydropur tyres, which also provide for smooth operation at high acceleration rates, complete the range of materials used for our travel wheels.

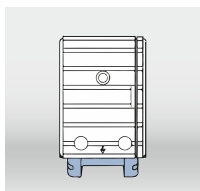

Travel wheels guided by flanges on both sides, with generous wear reserves for common rail systems or with a tread to your specifications.

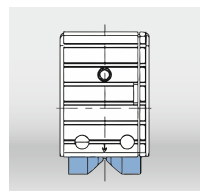

Travel wheels for guided applications in vertical and horizontal planes of prismatic or trapezoidal design or with a concave tread.

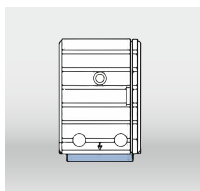

Travel wheels without flanges, if required with guide rollers for rigidly guided systems.



Spheroidal-graphite cast-iron wheels with a convex tread or of hardened design can also be supplied.

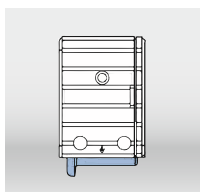

Travel wheels guided by a flange on one side for units running at floor level, also with a central flange for special requirements

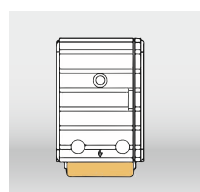

Flangeless travel wheels with a Hydropur tyre for high acceleration and smooth operation.

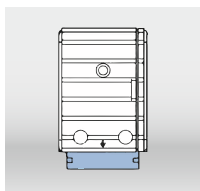

Large diameter travel wheels without a flange for increased ground clearance.

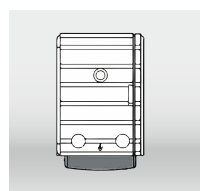

Polyamide travel wheels without a flange for quiet running and gentle on the runway.



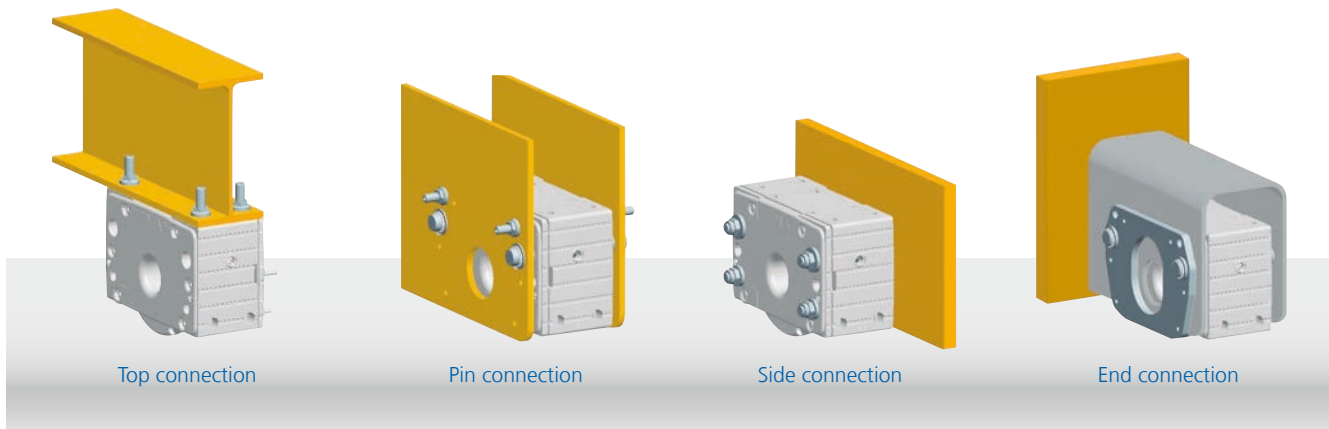

### CONNECTION VARIANTS

Prepared mounting surfaces facilitate virtually any connection arrangement – ranging from top and end connection arrangements with bolted and welded connection elements, to side and pin connection arrangements for installation in hollow profile sections and crossbeams. Top, end and pin connection arrangements make it possible to move and align the wheel blocks laterally even after they have been fitted.

### GUIDE ARRANGEMENT VARIANTS

Tailored solutions are also available for guiding wheel blocks. Flange-guided travel wheels and wheels with prism-shaped or concave treads for round cross-section rails provide for exact vertical and horizontal guide arrangements. If strong horizontal forces have to be reliably absorbed, infinitely adjustable guide rollers with a positive connection should be used.

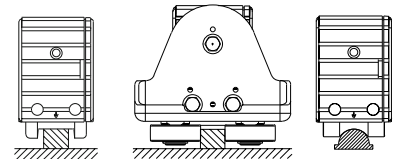
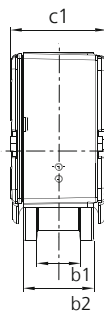
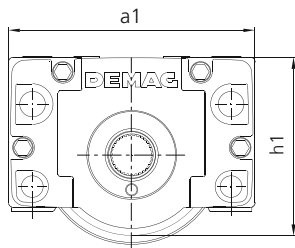

### TECHNICAL DATA

| Size    | Max. load capacity<br>[t] | Travel wheel diameter<br>[mm] | Weight<br>[kg] | Dimensions<br>[mm] |     |     |     |       |
|---------|---------------------------|-------------------------------|----------------|--------------------|-----|-----|-----|-------|
|         |                           |                               |                | a1                 | b1  | b2  | c1  | h1    |
| DRS 112 | 2.75                      | 112                           | 7.3            | 190                | 47  | 80  | 96  | 131   |
| DRS 125 | 5                         | 125                           | 9.9            | 220                | 60  | 80  | 98  | 147.5 |
| DRS 160 | 7                         | 160                           | 18.3           | 275                | 65  | 89  | 110 | 187   |
| DRS 200 | 10                        | 200                           | 35.7           | 340                | 65  | 101 | 130 | 238   |
| DRS 250 | 16                        | 250                           | 62             | 385                | 75  | 110 | 150 | 281   |
| DRS 315 | 22                        | 315                           | 117            | 470                | 90  | 130 | 180 | 349.5 |
| DRS 400 | 30                        | 400                           | 201            | 580                | 110 | 155 | 210 | 440   |
| DRS 500 | 40                        | 500                           | 352            | 700                | 110 | 170 | 240 | 566   |

### OPTIONS AND ACCESSORIES

Horizontal guide roller arrangements, rail-sweeper systems and buffers are available in various sizes and designs.

(DRS spheroidal-graphite cast-iron travel wheel with two flanges)

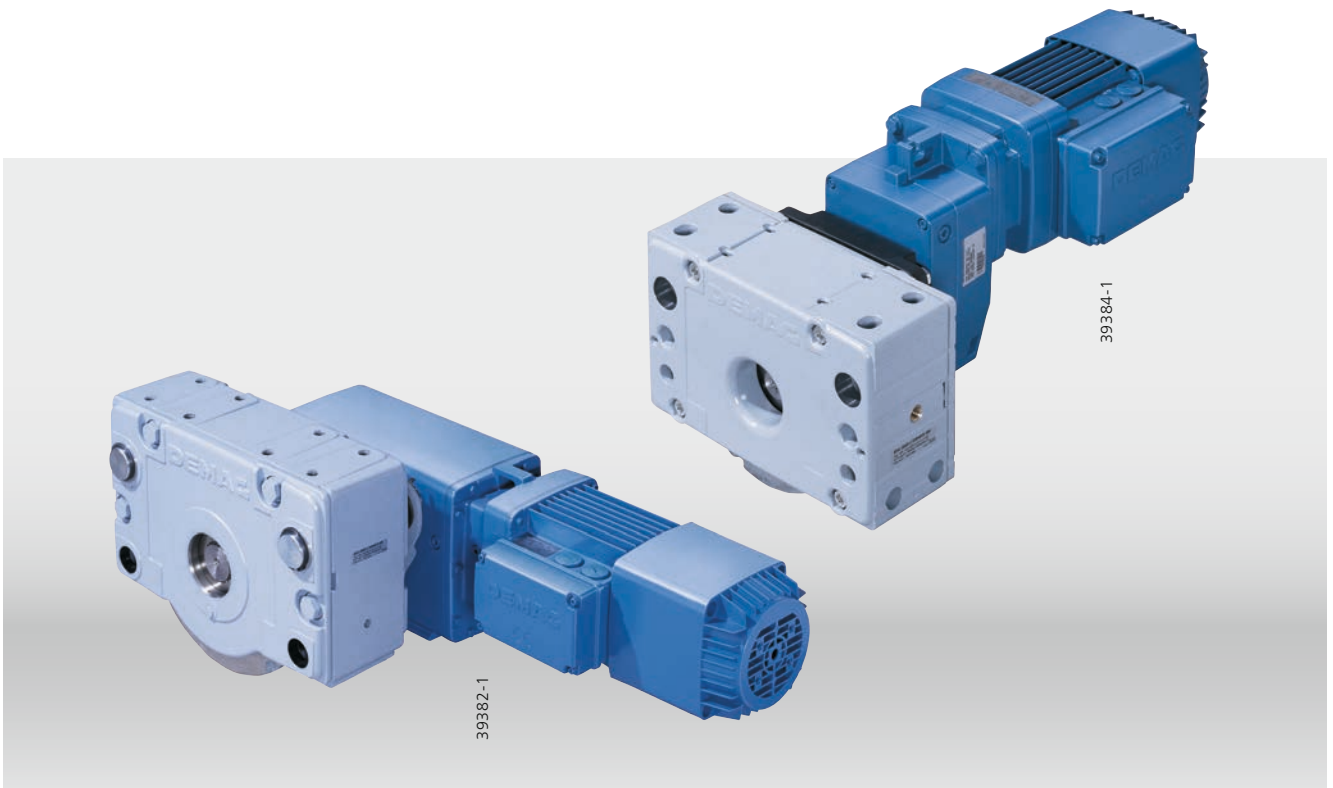

# The right drive

## – precisely matched to the Demag wheel range

Demag drive system components consisting of motors and gearboxes as well as inverters for particularly smooth and precise acceleration, braking and positioning are precisely matched to the Demag wheel range. The perfect combination of all components turns installations into efficient systems.

The direct drive input with a cylindrical-rotor motor and an additional flywheel variant is characterised by a shallow torque curve. The additional flywheel, arranged close to the offset or angular gearbox, also provides an optimum centre of gravity for the drive.

The coupling connection variant has the advantage that it can also be driven by our high-performance KB conical-rotor brake motors with their high starting frequency and braking capacity, for example for very demanding stopping and starting applications.

Drives can also be designed with one motor to drive two wheel blocks. These central drive arrangements guarantee absolute synchronous operation of pairs of wheel blocks.

In combination with the relevant torque bracket, the integrated torque ring cast into the housing cover of our offset gearboxes makes it possible to fix the drive in various positions relative to the DRS wheel block – in 15° steps to provide an optimum fit of the drive into the connecting structure.



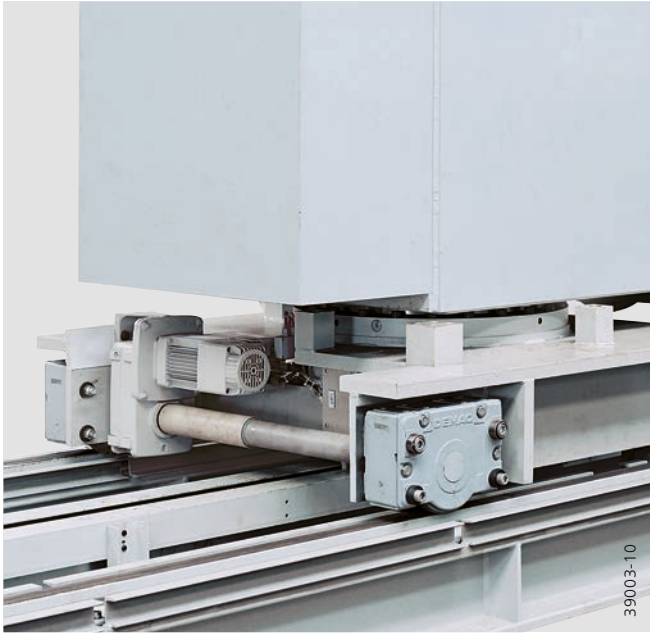

Furthermore, the patented torque bracket enables torque to be transmitted from the geared motor to the wheel block without any radial force. This reduces the load on the drive shaft and extends its service life.

In addition to special Demag travel motors for line-fed operation – also available as pole-changing units for two speeds – we offer standard drive motors with frequency inverters for electronically controlled operation, e.g. for exact positioning at low speeds. There are two frequency

inverter ranges: Dedrive Compact STO for motor outputs up to 110 kW and Dedrive Pro for motor outputs up to 560 kW. Demag FG microspeed drives provide outstanding characteristics if a wide ratio is required between the “positioning speed” and “fast speed”. They can be used to achieve transmission ratios of up to 500:1 with line-fed drives without the need for an inverter.





# Drive Designer online

## Simple project engineering

You can obtain optimum online support for your project engineering and design work at our website [www.demag-drivedesigner.com](http://www.demag-drivedesigner.com). Drive Designer facilitates rapid access to technical data and drawings of Demag wheel blocks and geared motors via the Internet. Use it as a configurator, for project engineering support and for enquiries.

Selection of the required wheel blocks is usually based on the planned load capacity. The speed at which a particular mass needs to be transported is also a key factor.

The corresponding components can be specified by entering the known parameters, such as the temperature range, cycle times, rail type and materials. The result is a complete, distinct type code. Any required options can also be selected. A data sheet shows all relevant technical data.

You can generate the corresponding dimension diagrams and product geometry details in the usual CAD formats for the selected combinations. Circuit diagrams show the electric connections for the motor.

### FURTHER DETAILS

- In addition to the configuration of complete 4-wheel carriages, travel units consisting of one, two, four or more wheel blocks can be individually designed and configured.
- Both offset gearboxes and angular gearboxes can be selected.
- When the configuration has been specified, the wheel blocks can be ordered direct in Demag Shop at [www.demag-shop.com](http://www.demag-shop.com).

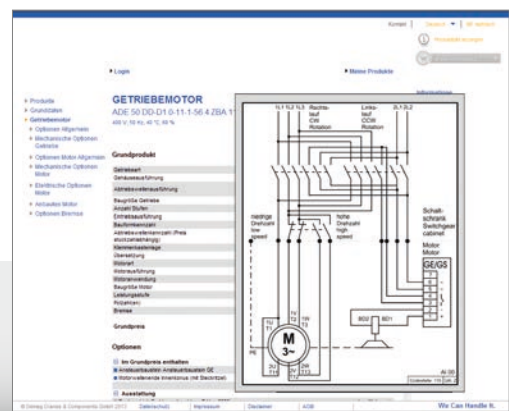

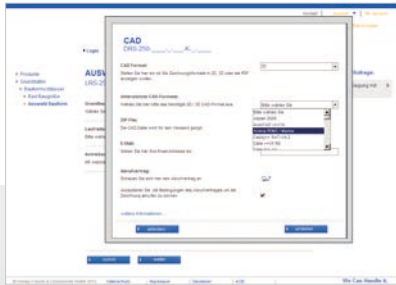

Selection of various CAD formats

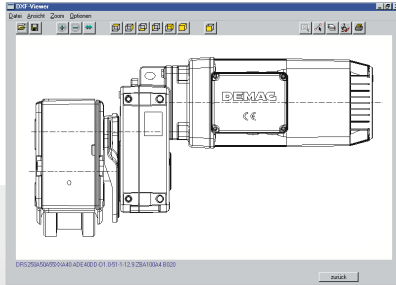

Individual 2D CAD files

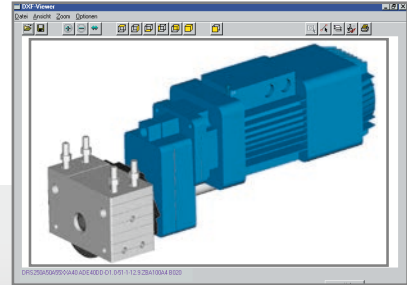

3D product geometries

## CALCULATE THE RIGHT DRIVE WITH CALDRIVE

The required output, loads and speeds need to be entered into Drive Designer to select travel units. Alternatively, the travel unit can be selected on the basis of the complete mounting code.

CalDrive calculation software is used to determine the required drive data from the specified physical characteristics.

The basic characteristics and data of Demag geared motors and wheel blocks are included in CalDrive. Drives for travel and lifting applications, as well as for roller, chain or belt conveyors can be specified with ease. The program suggests solutions for the combination of our offset, angular and helical gearboxes with cylindrical or conical-rotor motors. You can also determine solutions for line-fed or frequency inverter systems. Besides the technical data, you are also shown acceleration and deceleration values in the result.



41729

# Universal solutions for loads up to 6.5 t

## Demag LRS travel wheel system

The Demag LRS travel wheel system is a rugged system suitable for universal applications. It is the solution for travel applications with wheel loads weighing up to 6.5 t (at 100 m/min) and travel speeds up to 240 m/min. Simple project engineering makes LRS the ideal component for engineers who want to build their own solutions for a wide variety of travel applications.

### RUGGED AND MAINTENANCE-FREE

The LRS system requires virtually no maintenance and is suitable for operation at ambient temperatures from -10°C to +40°C. The five precisely machined connecting surfaces of the extremely rugged spheroidal-graphite cast-iron housing block offer a wide range of connection variants. It is fitted with top-connection bolts as standard. The LRS travel wheel system is available in two designs:

- **LRS...A** with a spheroidal-graphite cast-iron travel wheel and two flanges with high load capacity and good rolling and damping characteristics
- **LRS...F** as a travel wheel with a Hydropur tyre for very good traction and quiet running characteristics

Also available as optional accessories: a pin connection set, a buffer set, horizontal guide roller arrangement and

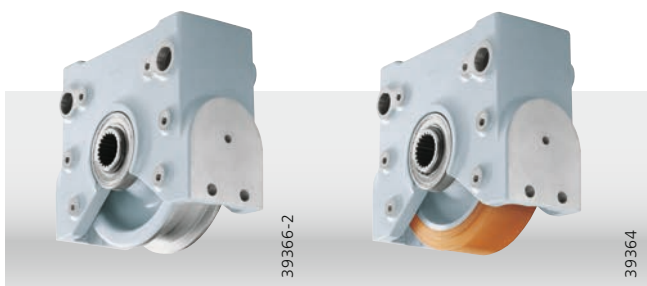

central drive unit set for track gauges of 1,500 mm and 2,900 mm.

### DRIVE

Demag offset and angular geared motors are ideally suited as travel drives for the Demag LRS travel wheel



Four-wheel trolley fitted with two individual drive units

Four-wheel trolley with central drive unit

system. The gearbox is connected to the LRS system with a hollow shaft featuring involute splines (to DIN 5480) by means of a shaft system and a matching torque bracket.

Various gearbox sizes are available with corresponding travel motors depending on the load to be moved and the required speed. Pole-changing geared travel motors can be selected from tables for line-fed operation (400 V, 50 Hz).



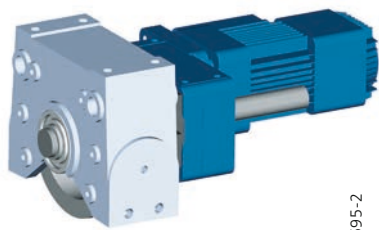
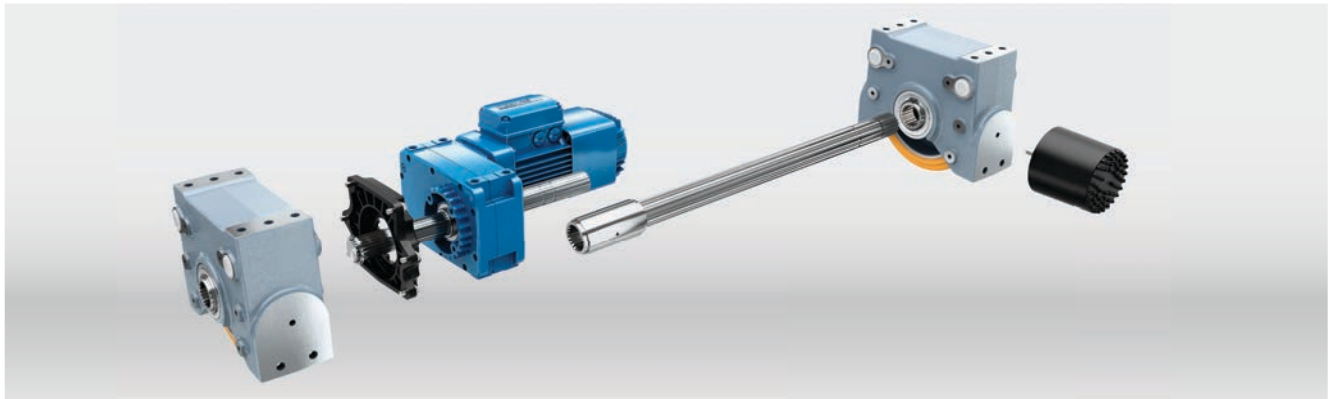

41595-2

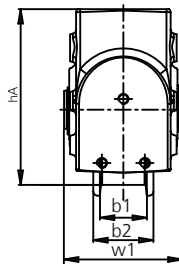

LRS...A

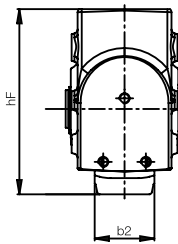

LRS...F

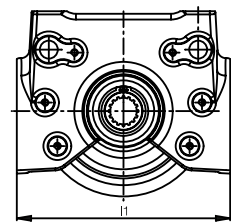

### FROM CAD MODEL TO CONVENIENT ONLINE ORDER

Visit our online configuration tool at [www.drives.demag-designer.com](http://www.drives.demag-designer.com) for 2D and 3D CAD files in various formats and use them for simple integration of the selected LRS components into your design.

In the Demag Shop system, you can either reserve or order the required component parts direct, specifying the shipping method as well as the required delivery date. When you have ordered components, we will immediately advise you of our order number and the calculated delivery date.



39886-10

### TECHNICAL DATA

| Size    | Travel wheel | Max. load capacity<br>[t] | Wheel dia.<br>[mm] | Weight<br>[kg] | [mm] |     |       |     |    |     |
|---------|--------------|---------------------------|--------------------|----------------|------|-----|-------|-----|----|-----|
|         |              |                           |                    |                | l1   | w1  | hA    | hF  | b1 | b2  |
| LRS 200 | A            | 2.5                       | 175                | 15.3           | 250  | 135 | 204.5 | 242 | 52 | 70  |
|         | F            | 1.2                       | 200                | 15.1           |      |     |       |     | -  | 70  |
| LRS 250 | A            | 3.5                       | 220                | 27.6           | 306  | 156 | 255   | 270 | 55 | 80  |
|         | F            | 1.7                       | 250                | 26.7           |      |     |       |     | -  | 80  |
| LRS 350 | A            | 6.5                       | 315                | 63.0           | 450  | 200 | 359.5 | 367 | 65 | 95  |
|         | F            | 3                         | 350                | 65.0           |      |     |       |     | -  | 110 |

A = travel wheel made of spheroidal-graphite cast iron with flange, F = travel wheel Hydropur tyre



# Special applications

## Demag RS wheel block system

The Demag RS wheel block system consists of a housing welded together from two sheet steel halves with an integrated travel wheel. It can be attached to customer structures with ease using its prepared connecting surfaces. The varied connection options also make it simple to add it to existing installations at a later date.

### MAIN RS FEATURES

- Load-bearing block enclosed on 5 sides with connecting surfaces featuring multiple bore holes
- Reamed lateral bore holes for the pin connection
- Integrated connections for torque brackets, guide roller arrangements and buffers
- Steel housing primed and finished with a top coat in RAL 7001
- Long service life of the steel and mechanical elements
- Rapid installation and removal for all connection variants
- Wide variety of standard travel wheel designs

### FOR PARTICULARLY TOUGH APPLICATIONS

The special designs for high temperature applications up to 150 °C or with furnace carriage bearings up to 250 °C are a special feature of the RS wheel block system.

The RS 125 size is available in stainless steel. It is particularly suitable for applications in the chemical industry, the foodstuffs sector and in aggressive environments.

### DRIVE

The gearbox has a hollow shaft featuring involute splines on the output side. The positive connection to the travel wheel shaft guarantees reliable torque transmission. This is particularly important for reversing and intermittent operation. The Demag modular system includes the D1 torque bracket (fitted direct to the wheel block) or D2 torque bracket (fitted to the customer's support superstructure) to accommodate the torque transmitted by the drive.

### COMPLETE TRAVEL UNIT

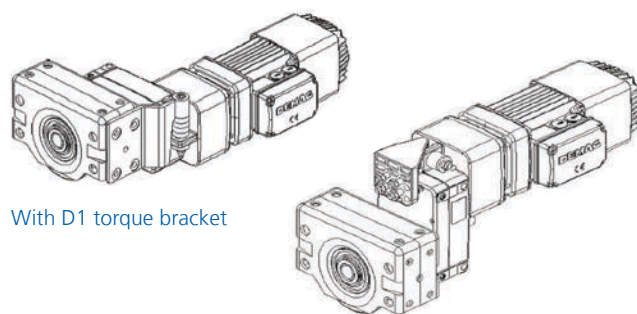

With D1 torque bracket

With D2 torque bracket

## CONNECTION VARIANTS

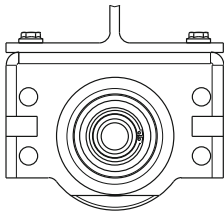

Top connection

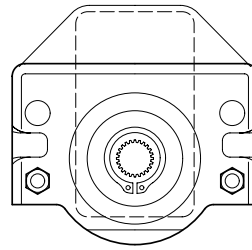
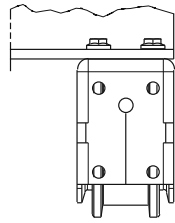

Side connection

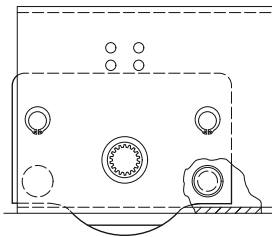
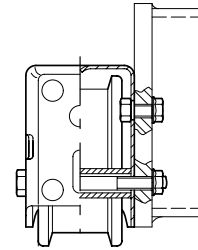

Pin connection

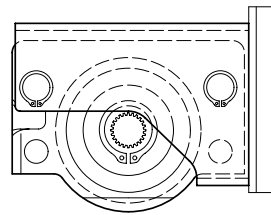
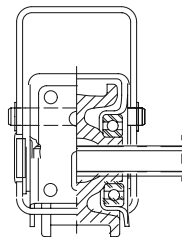

End connection

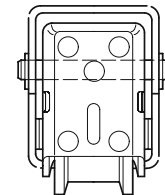

## TECHNICAL DATA

| Size   | Max. load capacity<br>[t] | Wheel dia.<br>[mm] | Weight<br>[kg] | [mm] |     |     |    |     |
|--------|---------------------------|--------------------|----------------|------|-----|-----|----|-----|
|        |                           |                    |                | a4   | l5  | h7  | b1 | b2  |
| RS 125 | 3.5                       | 125                | 8.0            | 220  | 98  | 148 | 60 | 68  |
| RS 160 | 5                         | 160                | 15             | 275  | 110 | 187 | 60 | 75  |
| RS 250 | 9                         | 250                | 40             | 385  | 150 | 281 | 65 | 100 |
| RS 315 | 12                        | 315                | 65             | 470  | 180 | 350 | 65 | 110 |
| RS 400 | 18                        | 400                | 153            | 580  | 210 | 440 | 80 | 140 |

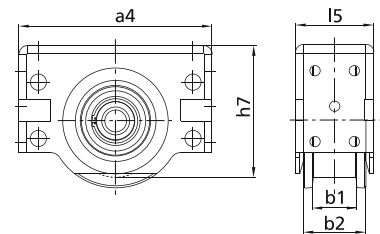

(RS with spheroidal-graphite cast-iron travel wheel with two flanges)



38132-2



37708-13



# The solution for heavy loads

## Demag DWS wheel set

Demag travel units are also used for rail-guided travel applications for heavy loads. DWS wheel sets are offered as driven and non-driven types to provide complete travel units. Demag offset or angular geared motors are used as drive units.

The use of these proven series-manufactured components offers a high level of operating reliability and guarantees interchangeability if the wheel is replaced. Owing to their versatility, DWS wheel sets are not only used in the crane and materials handling sector, but also for related mechanical engineering solutions.

The wheel sets can be installed in hollow profile sections and box girder sections and as corner bearing units.

Corner bearing arrangements offer the advantage of installing a pre-assembled wheel set in a travel unit without the need for extensive alignment. The unit can be rapidly replaced without the need for any alignment work, which ensures a high level of availability.

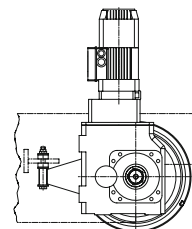

DWS with angular gearbox

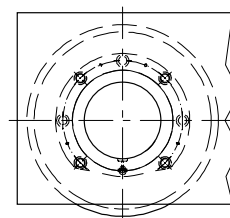

Fitted in hollow profile section

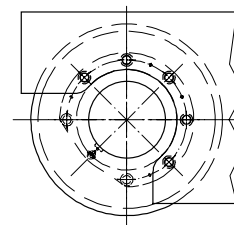

Corner bearing arrangement

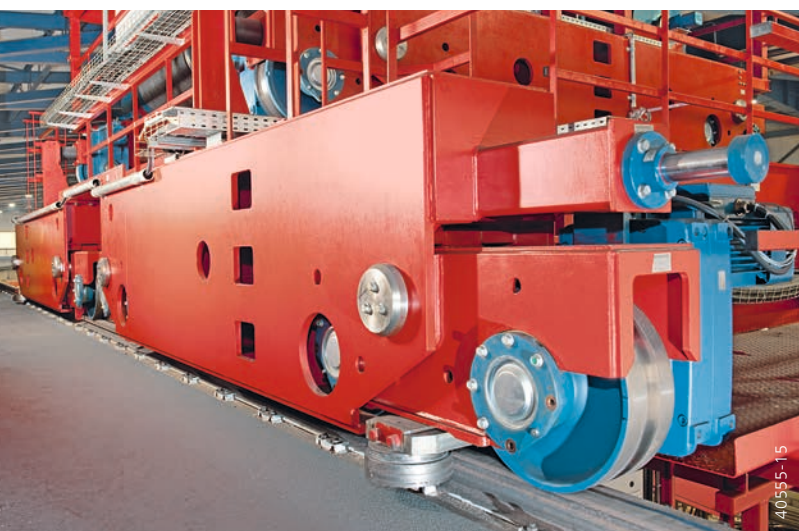

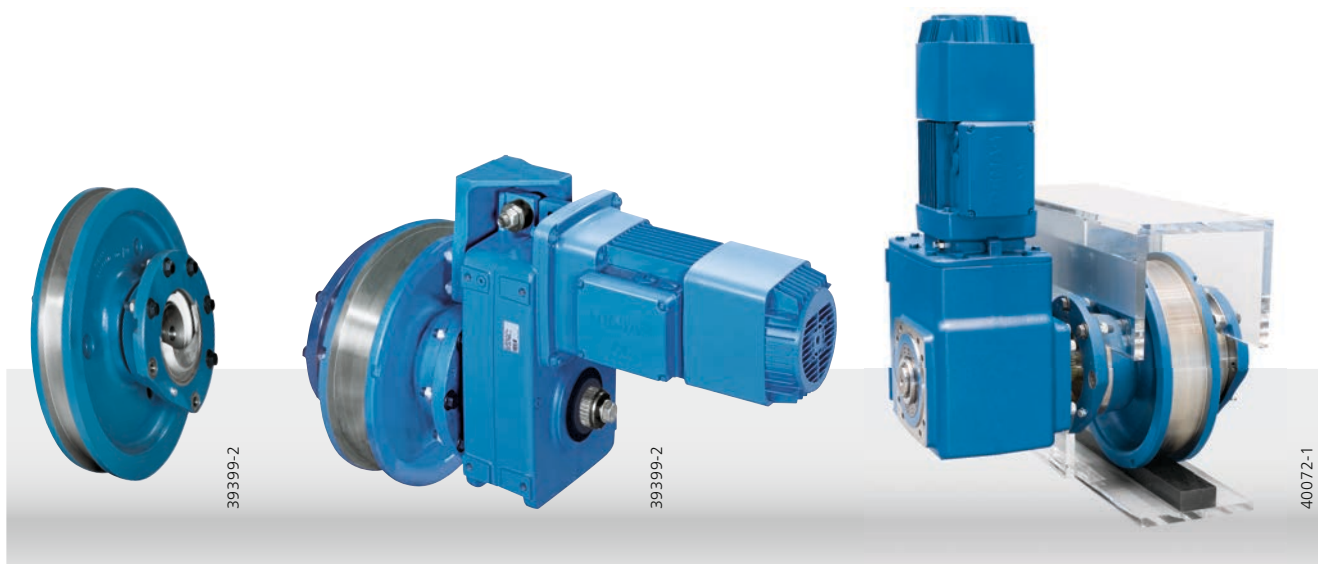

## DRIVE

Demag AUK/ADK offset gearboxes or WUK angular gearboxes with Z motors with direct drive input or with a coupling connection with KB motors are used as the drives.

The D2 or Arm2 torque bracket is also fitted to the supporting structure to form a complete solution with the motor and gearbox.

## DESIGN FEATURES

- Simple track gauge adjustment thanks to interchangeable distance washers between the anti-friction bearings and retaining rings
- Rapid installation and removal of the travel wheel from the travel unit using conventional tools
- Long service life thanks to standard re-lubrication facility
- Driven design matched to Demag offset or angular geared motors
- Guide flange wear indicator
- Flange bearings provided with recesses to attach extractors

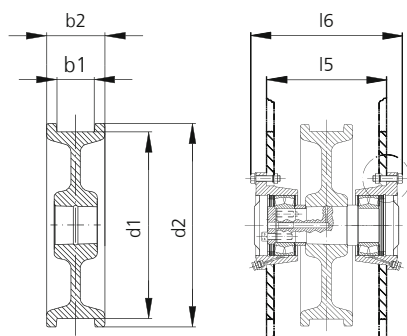

## TECHNICAL DATA

| Size    | Max. load capacity<br>[t] | Wheel diameter<br>d1 [mm] | Weight<br>[kg] | [mm] |     |     |     |     |  |
|---------|---------------------------|---------------------------|----------------|------|-----|-----|-----|-----|--|
|         |                           |                           |                | l5   | l6  | d2  | b1* | b2  |  |
| DWS 400 | 28                        | 400                       | 105            | 280  | 362 | 437 | 80  | 125 |  |
|         |                           |                           |                |      |     |     | 90  | 140 |  |
| DWS 500 | 40                        | 500                       | 142            | 320  | 402 | 537 | 90  | 140 |  |
|         |                           |                           |                |      |     |     | 110 | 170 |  |
| DWS 630 | 60                        | 630                       | 310            | 350  | 456 | 680 | 75  | 140 |  |
|         |                           |                           |                |      |     |     | 110 | 170 |  |

\* Other treads on request

# Demag drives – from components to systems

## GEARED MOTORS

- Helical geared motors from 90 to 1,800 Nm
- Angular geared motors from 120 to 12,000 Nm
- Offset geared motors from 130 to 11,500 Nm with cylindrical-rotor motors from 0.18 to 45 kW.

## BRAKE MOTORS

- KB conical-rotor motors for demanding requirements such as extremely high switching frequencies and braking operation for outputs from 0.37 to 42 kW
- Z cylindrical-rotor motors as standard motors for outputs from 0.18 to 45kW or as travel motors with integrated flywheel mass

## MICROSPEED DRIVES

- With conical-rotor motors
- For high speed ranges and positioning with high stopping accuracy
- Speed ratios up to 500 : 1

## TRAVEL UNIT COMPONENTS

- Modular systems for elements in materials handling installations and mechanical engineering applications without the need for any additional design work and production
- Wheel systems and wheel sets ready for installation for wheel loads up to 60 t
- Travel drives designed to match the wheel systems

## FREQUENCY INVERTERS

- Dedrive Compact STO and
- Dedrive Pro for AC drives with motor shaft outputs up to 560 kW
- Control of cylindrical and conical-rotor motors as single or groups of drives
- Current loads from 2.4 to 210 A and 4.2 to 544 A, respectively

## POWER SUPPLY LINE

- To supply mobile consumers with electric power
- Rated for currents up to 200 A (100% CDF)
- Fitted with up to 7 conductors, as required

## Solid Service Throughout Asia-Pacific

### ■ SINGAPORE

MHE-Demag (S) Pte Ltd  
33 Gul Circle, Jurong,  
Singapore 629570,  
Republic of Singapore  
Phone : +65 6305 3500  
Fax : +65 6862 1933  
Service: +65 6862 1123

### ■ INDONESIA

PT MHE-Demag Indonesia  
Graha Inti Fauzi Building, Floor 7,  
Jalan Buncit Raya No. 22,  
Jakarta Selatan 12510,  
DKI Jakarta, Indonesia  
Phone : +62 21 2753 7200  
Fax : +62 21 2753 7201  
Service: +62 21 2753 7250

### ■ TAIWAN

MHE-Demag Taiwan Co. Ltd.  
5F.-3, No. 286, Xinya Rd., Qianzhen Dist.,  
Kaohsiung City 806, Taiwan (R.O.C.)  
Phone : +886 7 970 8900  
Fax : +886 7 970 8901  
Service: +886 7 970 8910

### ■ MALAYSIA

MHE-Demag (M) Sdn Bhd  
No.15, Persiaran Astana / KU 2,  
Bandar Bukit Raja, 41050 Klang,  
Selangor, Malaysia  
Phone : +60 3 3345 7888  
Fax : +60 3 3345 7999  
Service: +60 3 3345 7777

### ■ PHILIPPINES

MHE-Demag (P) Inc  
Main Avenue, Severina Diamond  
Industrial Estate, Km 16, West Service Road,  
South Expressway 1700 Parañaque City,  
Metro Manila, Philippines  
Phone : +63 2 786 7500  
Fax : +63 2 786 7555  
Service: +63 2 821 5149

### ■ AUSTRALIA

MHE-Demag Australia Pty Ltd  
92 Long Street, Smithfield  
NSW 2164, Australia  
Phone : +61 2 9609 9500  
Fax : +61 2 9609 9519  
Service: +61 1300 336 241

### ■ THAILAND

MHE-Demag (T) Ltd  
23/110-117 Sorachai Building, 25-29th Floor,  
Soi Sukhumvit 63 (Ekamai), Sukhumvit Road,  
Klongton Nua, Wattana, Bangkok 10110, Thailand  
Phone : +66 2 787 8500  
Fax : +66 2 787 8501  
Service: +66 2 787 8555

### ■ VIETNAM

MHE-Demag Vietnam Co. Ltd.  
Unit 15, Street 2, Vietnam Singapore  
Industrial Park, Thuan An Town,  
Binh Duong Province, Vietnam  
Phone : +84 650 378 4080  
Fax : +84 650 378 4082  
Service: +84 8 3823 6540

with **70**  
over  
**SERVICE**  
**CENTRES**  
ACROSS THE REGION



[sales\\_mhe@mhe-demag.com](mailto:sales_mhe@mhe-demag.com)  
[www.mhe-demag.com](http://www.mhe-demag.com)

**DEMAG**  
.....