

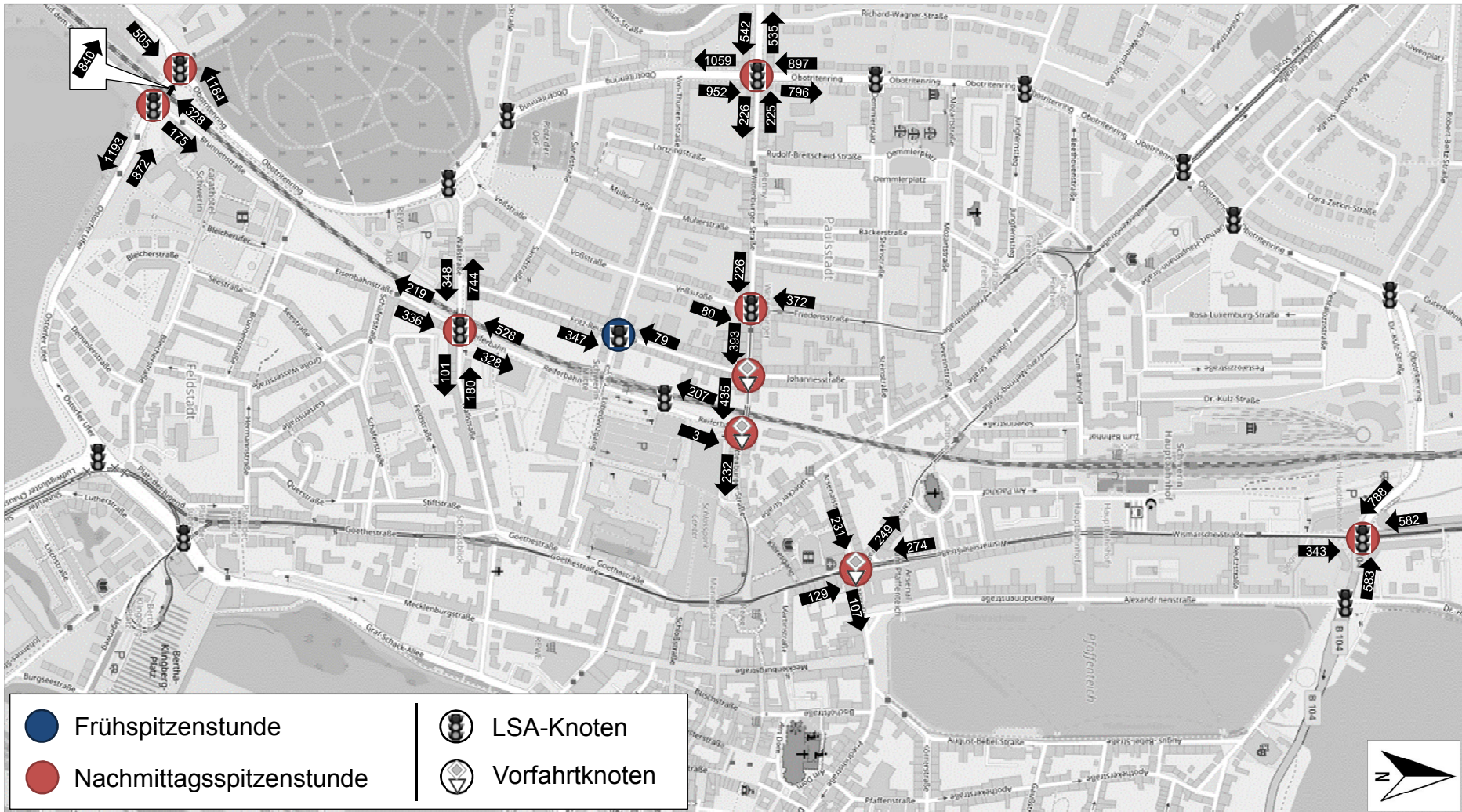

# Stündliche Streckenverkehrsbelastungen im Bestand

## Ausgewählte Verkehrszählungen der Landeshauptstadt Schwerin 2017+2018



Kartengrundlage: OpenStreetMap / © OpenStreetMap-Mitwirkende



## Leistungsfähigkeitsbewertungen im Bestand

### Gesamtqualität an ausgewählten Knotenpunkten

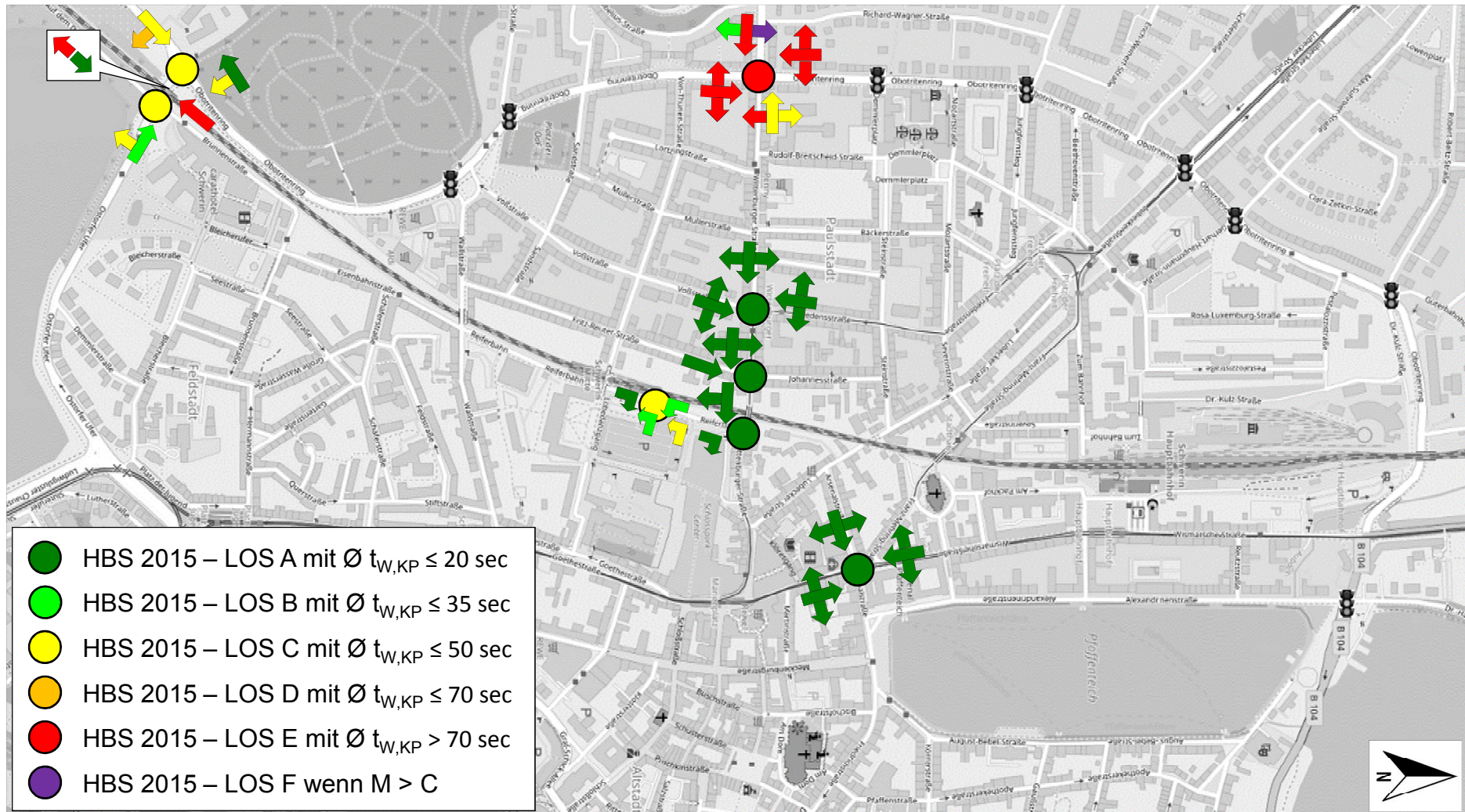



# Verkehrsmengen

# Bestand

Obotritenring / Ostorfer Ufer / A.-d.-Dwang, 20.09.2017 - Nachmittagsspitzenstunde in Kfz/h incl. SV

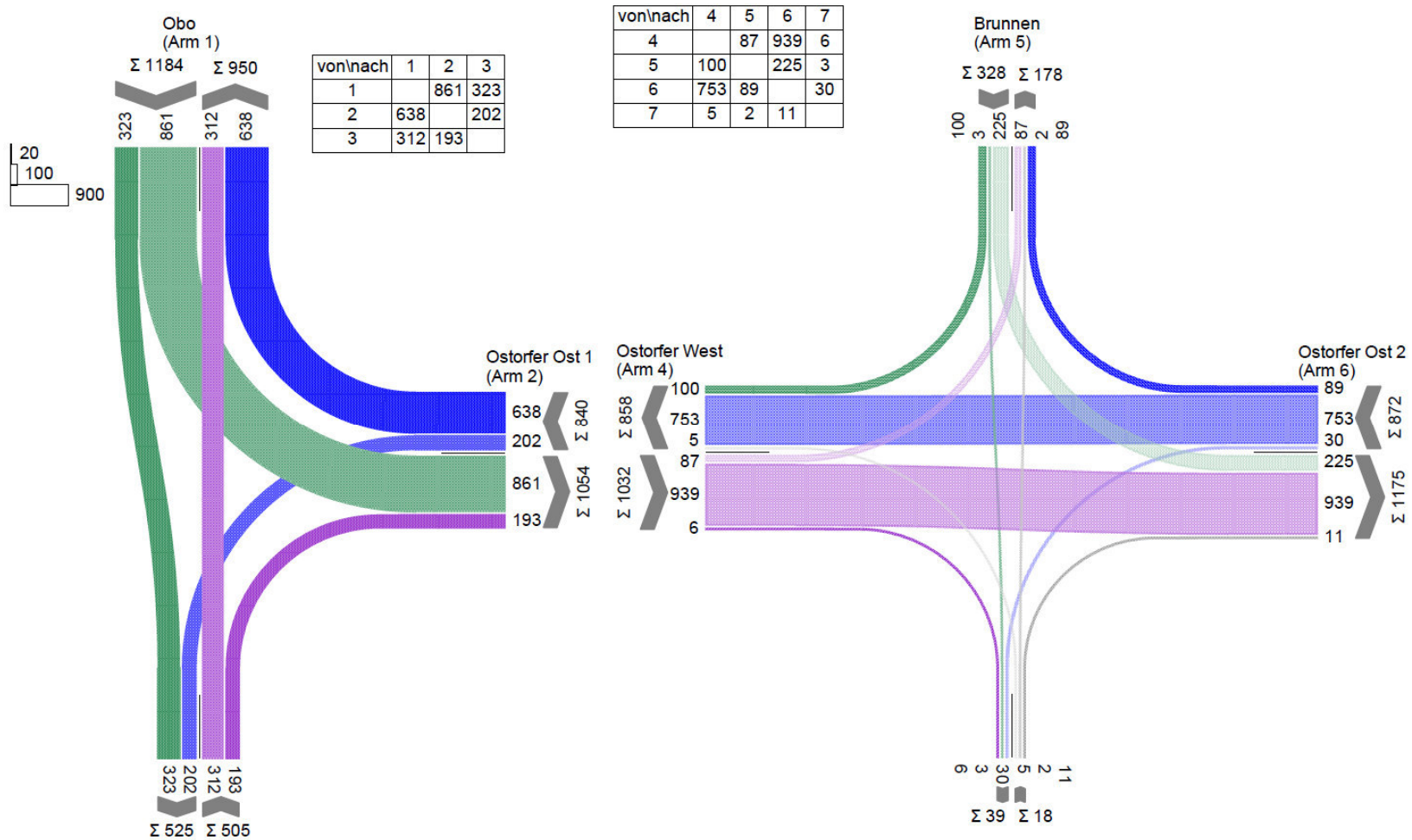



## Leistungsfähigkeiten und Verkehrsqualität

Obotritenring / Ostorfer Ufer / A.-d.-Dwang ; NSP ;  $T_U = 100$  sec

Zuf	Fstr.Nr.	Symbol	SGR	$t_f$ [s]	$t_A$ [s]	$t_s$ [s]	$f_A$	q [Kfz/h]	m [Kfz/U]	$t_b$ [s/Kfz]	$q_s$ [Kfz/h]	$N_{MS,95>NK}$	$n_c$ [Kfz/U]	C [Kfz/h]	x	$t_w$ [s]	$N_{G\epsilon}$ [Kfz]	$N_{MS}$ [Kfz]	$N_{MS,95}$ [Kfz]	$L_x$ [m]	QSV	Bemerkung	
1	1	↓	K5-TK1	57	58	43	0,580	323	8,972	1,809	1990	-	32	1154	0,280	11,223	0,222	4,721	8,396	50,628	A		
	3	↘	K1-TK1	36	37	64	0,370	476	13,222	2,066	1742	-	18	645	0,738	38,679	2,039	13,498	19,712	121,229	C		
	4	↘	K1-TK1	36	37	64	0,370	385	10,694	2,048	1758	-	18	650	0,592	30,512	0,921	9,548	14,774	90,062	B		
2	1	↑	K2-TK1	73	74	27	0,740	322	8,944	2,062	1746	-	36	1292	0,249	4,667	0,188	3,039	5,987	36,748	A		
	3	↑	K2-TK1	73	74	27	0,740	316	8,778	2,016	1786	-	37	1322	0,239	4,591	0,178	2,951	5,856	35,136	A		
	4	↖	K4-TK1	29	30	71	0,300	202	5,611	2,046	1760	(x)	15	528	0,383	30,155	0,363	4,801	8,507	51,808	B		
3	4	↑	K3-TK1	17	18	83	0,180	155	4,306	1,800	2000	-	10	360	0,431	40,918	0,447	4,274	7,770	46,620	C		
	3	↑	K3-TK1	17	18	83	0,180	157	4,361	1,834	1963	-	10	353	0,445	41,391	0,475	4,362	7,894	48,264	C		
	1	↘	K7-TK1	16	17	84	0,170	193	5,361	2,078	1732	(x)	8	294	0,656	53,854	1,232	6,240	10,465	64,736	D		
4	4	↖	K1-TK2, K1L-TK2	58	59	42	0,590	87	2,417	2,085	1727	(x)	12	423	0,206	31,259	0,146	2,068	4,500	27,918	B		
	3	→	K1-TK2	58	59	42	0,590	421	11,694	1,832	1965	-	32	1159	0,363	11,727	0,332	6,433	10,723	65,496	A		
	1	↘	K1-TK2	58	59	42	0,590	524	14,556	1,854	1942	-	32	1146	0,457	13,091	0,504	8,675	13,656	84,312	A		
5	1	↔	K4-TK2	19	20	81	0,200	328	9,111	2,023	1780	-	9	332	0,988	176,427	12,532	21,618	29,481	176,886	E		
6	1	↖	K3-TK2	32	33	68	0,330	89	2,472	2,016	1786	-	16	589	0,151	24,233	0,100	1,843	4,139	24,834	B		
	3	←	K3-TK2	32	33	68	0,330	378	10,500	1,836	1961	-	18	647	0,584	32,733	0,886	9,600	14,840	90,821	B		
	4	←	K3-TK2	32	33	68	0,330	375	10,417	1,814	1985	-	18	655	0,573	32,307	0,842	9,449	14,648	88,591	B		
	5	↖	K3-TK2, K3L-TK2	32	33	68	0,330	30	0,833	2,016	1786	-	5	172	0,174	44,025	0,118	0,884	2,474	14,844	C		
7	1	↔	K2-TK2	18	19	82	0,190	18	0,500	1,992	1807	-	10	343	0,052	33,447	0,030	0,439	1,560	9,360	B		
Knotenpunktssummen:								4779						12064									
Gewichtete Mittelwerte:															0,493	34,948							<b>C</b>
				TU = 100 s T = 3600 s																			
				(x) Für diese Spuranordnung ist nach HBS 2015 keine Berechnung kurzer Aufstellstreifen definiert.																			



## Verkehrsmengen

## Bestand

Obotritenring / Wittenburger Straße, 26.04.2017 - Nachmittagsspitzenstunde in Kfz/h incl. SV

von\nach	1	2	3	4
1		158	97	287
2	157		63	677
3	86	44		95
4	292	594	66	

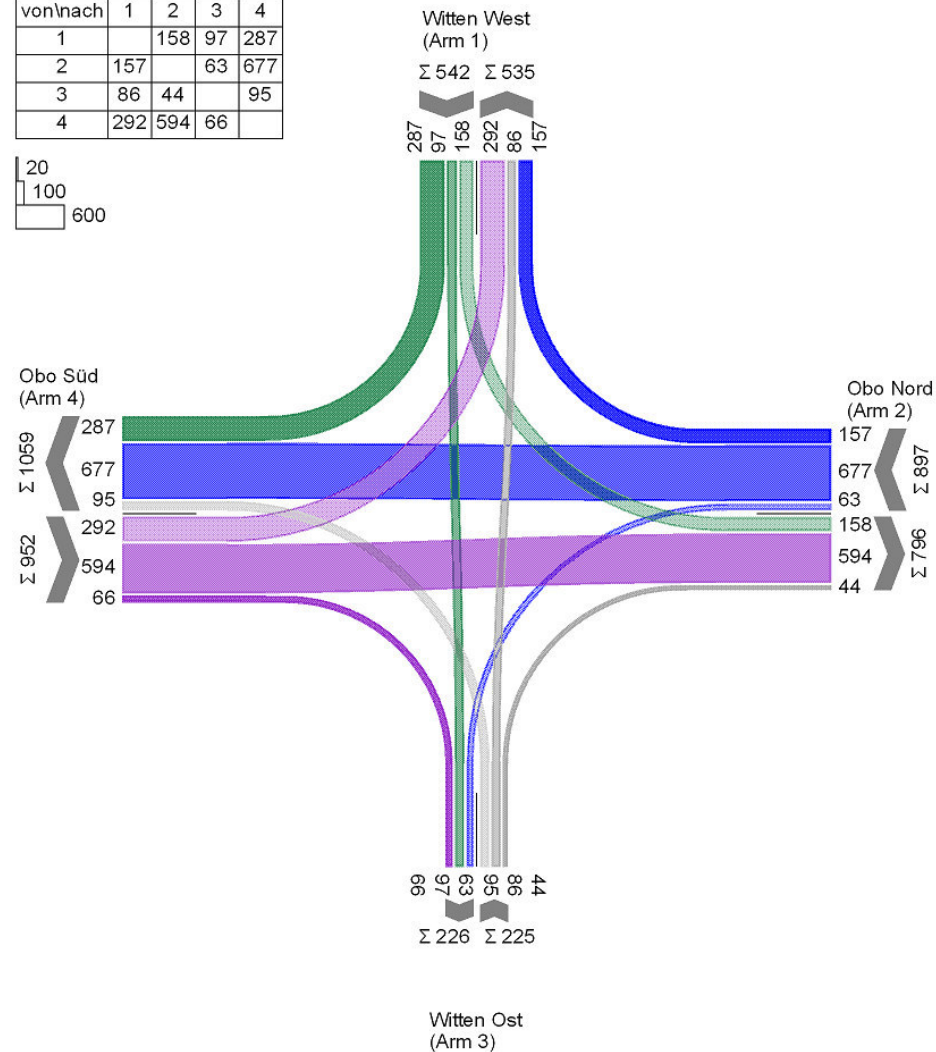
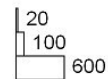



## Leistungsfähigkeiten und Verkehrsqualität <sup>1)</sup>

Obotritenring / Wittenburger Straße; NSP ;  $T_U = 100 \text{ sec}$

Zuf	Fstr.Nr.	Symbol	SGR	t <sub>r</sub> [s]	t <sub>a</sub> [s]	t <sub>s</sub> [s]	f <sub>A</sub>	q [Kfz/h]	m [Kfz/U]	t <sub>b</sub> [s/Kfz]	q <sub>s</sub> [Kfz/h]	N <sub>MS,95&gt;nK</sub>	nc [Kfz/U]	C [Kfz/h]	x	t <sub>w</sub> [s]	N <sub>GE</sub> [Kfz]	N <sub>MS</sub> [Kfz]	N <sub>MS,95</sub> [Kfz]	L <sub>x</sub> [m]	QSV	Bemerkung	
1	1	↙	K4, KR4	46	47	54	0,470	287	7,972	2,052	1754	-	21	753	0,381	21,208	0,360	5,802	9,876	60,323	B		
	3	↓	K4	16	17	84	0,170	97	2,694	1,800	1817	-	9	309	0,825	80,386	3,461	10,299	15,727	94,362	E		
	4	↘	K4, K4L_Gn	16	17	84	0,170	158	4,389	2,093	1720	x								74,144			
2	1	↖	K1	27	28	73	0,280	418	11,611	1,885	1952	-	13	480	0,871	79,060	5,755	16,885	23,835	143,010	E		
	3	↙	K1, K1L	27	28	73	0,280	479	13,306	1,832	1978	-	15	550	0,871	73,664	6,017	18,687	25,998	156,300	E		
3	3	↙	K2	17	18	83	0,180	95	2,639	1,814	1985	-	4	142	0,669	76,928	1,250	3,823	7,130	43,122	E		
	1	↖	K2	17	18	83	0,180	130	3,611	2,213	1627	-	7	267	0,487	45,636	0,568	3,849	7,167	44,894	C		
4	3	↖	K3, K3L	27	28	73	0,280	474	13,167	1,951	1906	-	14	516	0,919	101,536	9,551	22,316	30,305	183,648	E		
	1	↖	K3	27	28	73	0,280	478	13,278	1,854	1952	-	14	521	0,917	100,549	9,411	22,297	30,283	183,333	E		
Knotenpunktssummen:								2616						3538									
Gewichtete Mittelwerte:															0,803	78,115							<b>E</b>
				TU = 100 s T = 3600 s																			

<sup>1)</sup> Die Freigabezeiten der Kfz-Querrichtung K2 und K4 wurden anteilig errechnet, unter Berücksichtigung einer - lt. SIPL-Online-Mittschnitt - R1/R3-Anforderungshäufigkeit von 16%, die sich auf die Freigabezeit der Kfz-Querrichtung auswirkt.



## Verkehrsmengen

Wittenburger Straße / Voßstraße, 10.10.2017 - Nachmittagsspitzenstunde in Kfz/h incl. SV

von/nach	1	2	3	4
1			205	21
2	115		168	89
3				
4	60		20	

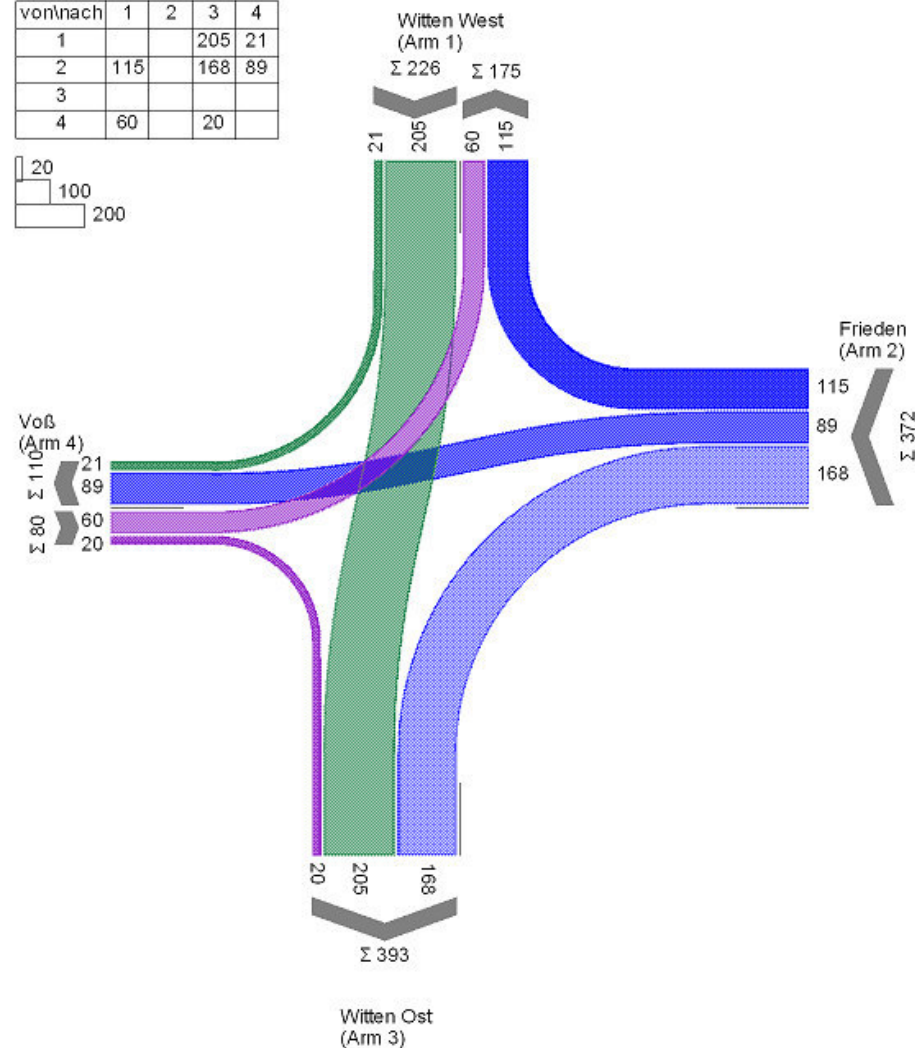
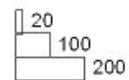



# Leistungsfähigkeiten und Verkehrsqualität

## Wittenburger Straße / Voßstraße; NSP

Bestand

Arm	Zufahrt	Vorfahrtsregelung	Verkehrsstrom
1	C	Vorfahrtsstraße	8
			9
2	B	Vorfahrt gewähren!	4
			5
			6
3	A	Vorfahrtsstraße	1
			2
4	D	Vorfahrt gewähren!	10
			12

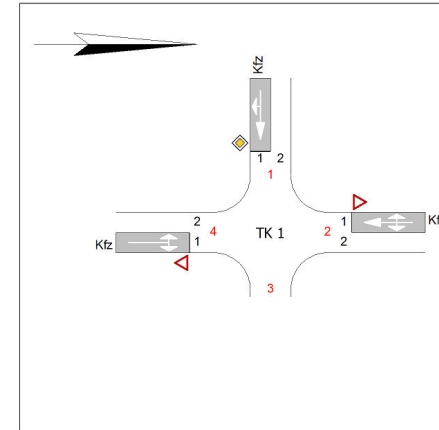

Arm	Zufahrt	Strom	Verkehrsstrom	qFz [Fz/h]	qPE [Pkw-E/h]	C <sub>PE</sub> [Pkw-E/h]	C <sub>Fz</sub> [Fz/h]	x <sub>i</sub> [-]	R [Fz/h]	tw [s]	QSV
3	A	3 → 4	1	0,0	0,0	994,0	903,5	0,000	903,5	4,0	A
		3 → 1	2	0,0	0,0	1.800,0	1.636,5	0,000	1.636,5	2,2	A
		-	3	-	-	-	-	-	-	-	-
2	B	2 → 3	4	168,0	168,5	798,5	796,0	0,211	628,0	5,7	A
		2 → 4	5	89,0	89,0	794,5	794,5	0,112	705,5	5,1	A
		2 → 1	6	115,0	118,5	1.200,0	1.165,0	0,099	1.050,0	3,4	A
1	C	-	7	-	-	-	-	-	-	-	-
		1 → 3	8	205,0	217,0	1.800,0	1.699,5	0,121	1.494,5	2,4	A
		1 → 4	9	21,0	21,0	1.600,0	1.600,0	0,013	1.579,0	2,3	A
4	D	4 → 1	10	60,0	60,5	508,5	504,5	0,119	444,5	8,1	A
		-	11	-	-	-	-	-	-	-	-
		4 → 3	12	20,0	20,5	922,0	899,5	0,022	879,5	4,1	A
Mischströme											
3	A	-	1+2+3	-	-	-	-	-	-	-	A
2	B	-	4+5+6	372,0	376,0	891,0	881,5	0,422	509,5	7,1	A
1	C	-	7+8+9	-	-	-	-	-	-	-	A
4	D	-	10+11+12	80,0	81,0	574,5	567,0	0,141	487,0	7,4	A
Gesamt QSV											<b>A</b>





# Verkehrsmengen

Wittenburger Straße / Fr.-Reuter-Straße, Kfz/h incl. SV

von/nach	1	2	3	4
1		37	263	56
2			3	16
3	40	4		4
4	8	127	103	

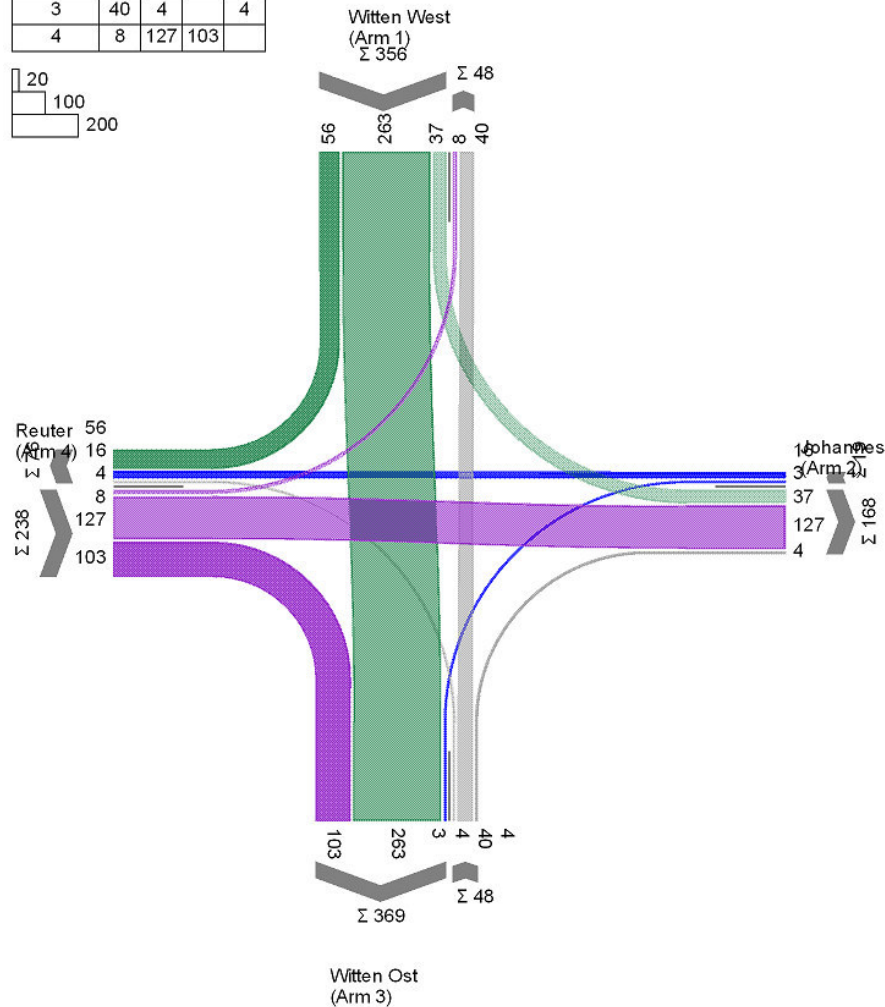
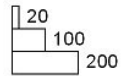



# Leistungsfähigkeiten und Verkehrsqualität

## Wittenburger Straße / Fr.-Reuter-Straße

Bestand

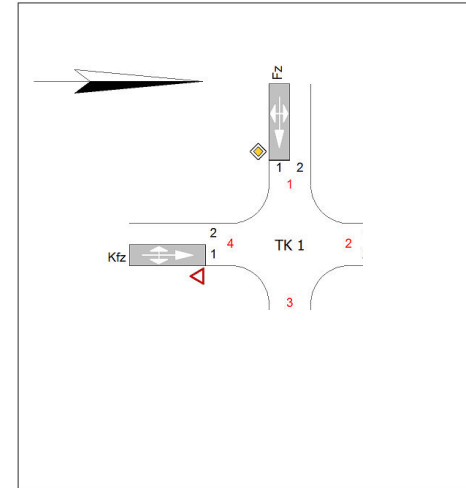

Arm	Zufahrt	Vorfahrtsregelung	Verkehrsstrom
1	C	Vorfahrtsstraße	7
			8
			9
2	B	Vorfahrt gewähren!	6
3	A	Vorfahrtsstraße	3
4	D	Vorfahrt gewähren!	10
			11
			12

Arm	Zufahrt	Strom	Verkehrsstrom	qFz [Fz/h]	qPE [Pkw-E/h]	CPE [Pkw-E/h]	CFz [Fz/h]	xi [-]	R [Fz/h]	tw [s]	QSV
3	A	-	1	-	-	-	-	-	-	-	-
		-	2	-	-	-	-	-	-	-	-
		-	3	-	-	-	-	-	-	-	-
2	B	2 → 3	4	3,0	1,5	451,0	902,0	0,003	899,0	4,0	A
		2 → 4	5	16,0	11,0	761,0	1.106,0	0,014	1.090,0	3,3	A
		-	6	-	-	-	-	-	-	-	-
1	C	1 → 2	7	37,0	36,5	1.600,0	1.622,5	0,023	1.585,5	2,3	A
		1 → 3	8	259,0	243,0	1.800,0	1.919,0	0,135	1.660,0	2,2	A
		1 → 4	9	56,0	54,5	1.600,0	1.644,5	0,034	1.588,5	2,3	A
4	D	4 → 1	10	8,0	4,0	760,0	1.520,0	0,005	1.512,0	2,4	A
		4 → 2	11	127,0	123,5	785,0	807,5	0,157	680,5	5,3	A
		4 → 3	12	103,0	101,5	845,0	858,0	0,120	755,0	4,8	A
Mischströme											
3	A	-	1+2+3	-	-	-	-	-	-	-	A
2	B	-	4+5+6	19,0	12,5	735,5	1.118,0	0,017	1.099,0	3,3	A
1	C	-	7+8+9	-	-	-	-	-	-	-	A
4	D	-	10+11+12	238,0	229,0	812,0	844,0	0,282	606,0	5,9	A
Gesamt QSV											<b>A</b>

Gesamt QSV

**A**



## Verkehrsmengen

## Bestand

Wittenburger Straße / Reiferbahn, 20.03.2018 - Nachmittagsspitzenstunde in Kfz/h incl. SV

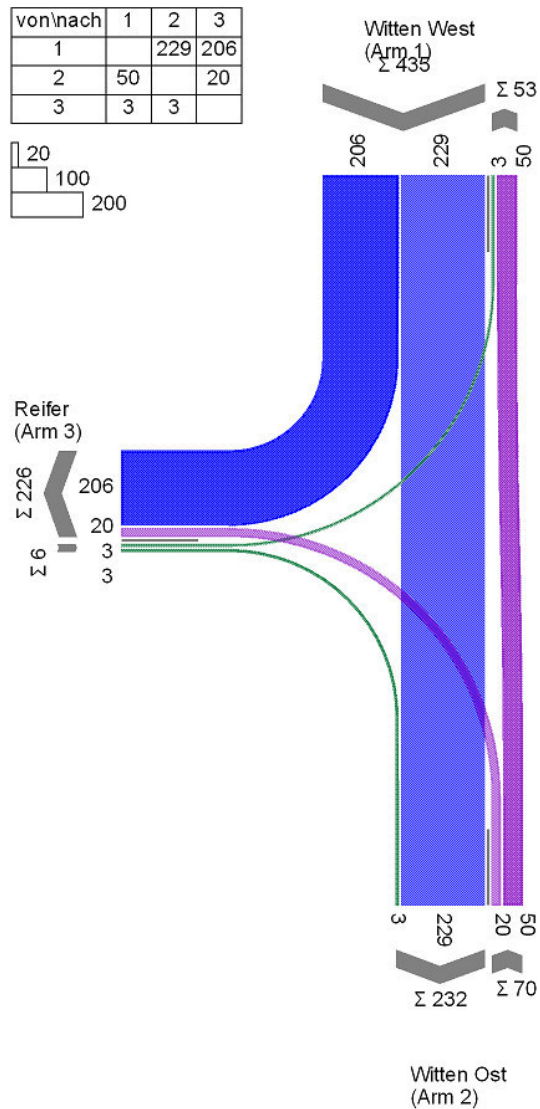



# Leistungsfähigkeiten und Verkehrsqualität

## Wittenburger Straße / Reiferbahn; NSP

Bestand

Arm	Zufahrt	Vorfahrtsregelung		Verkehrsstrom
1	A		Vorfahrtsstraße	2
				3
2	C		Vorfahrtsstraße	7
				8
3	B		Vorfahrt gewähren!	4
				6

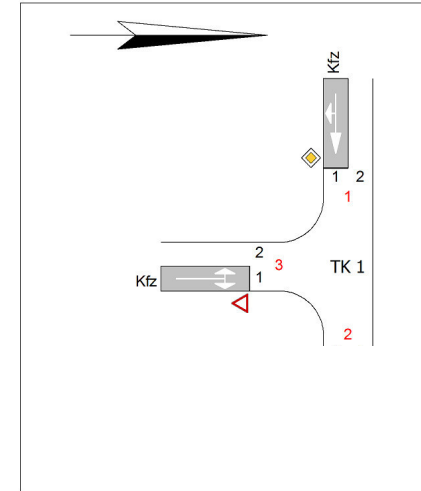

Arm	Zufahrt	Strom	Verkehrsstrom	q <sub>Fz</sub> [Fz/h]	q <sub>PE</sub> [Pkw-E/h]	C <sub>PE</sub> [Pkw-E/h]	C <sub>Fz</sub> [Fz/h]	x <sub>i</sub> [-]	R [Fz/h]	t <sub>w</sub> [s]	QSV
1	A	1 → 2	2	229,0	231,0	1.800,0	1.784,0	0,128	1.555,0	2,3	A
		1 → 3	3	206,0	206,0	1.600,0	1.600,0	0,129	1.394,0	2,6	A
3	B	3 → 1	4	3,0	3,0	633,5	633,5	0,005	630,5	5,7	A
		3 → 2	6	3,0	3,0	799,5	799,5	0,004	796,5	4,5	A
2	C	2 → 3	7	20,0	20,0	783,5	783,5	0,026	763,5	4,7	A
		2 → 1	8	50,0	50,0	1.800,0	1.800,0	0,028	1.750,0	2,1	A
Mischströme											
3	B	-	4+6	6,0	6,0	666,5	666,5	0,009	660,5	5,5	A
2	C	-	7+8	70,0	70,0	1.800,0	1.800,0	0,039	1.730,0	2,1	A
Gesamt QSV											<b>A</b>



## Verkehrsmengen

# Bestand

Reiferbahn / Parkplatz Schloßparkcenter, 20.03.2018 - Nachmittagsspitzenstunde in Kfz/h incl. SV

von\nach	1	2	3
1		328	
2	194		
3	396		

von\nach	4	5	6	7	9
4					
5	264				
6	70				
7			207		
9					

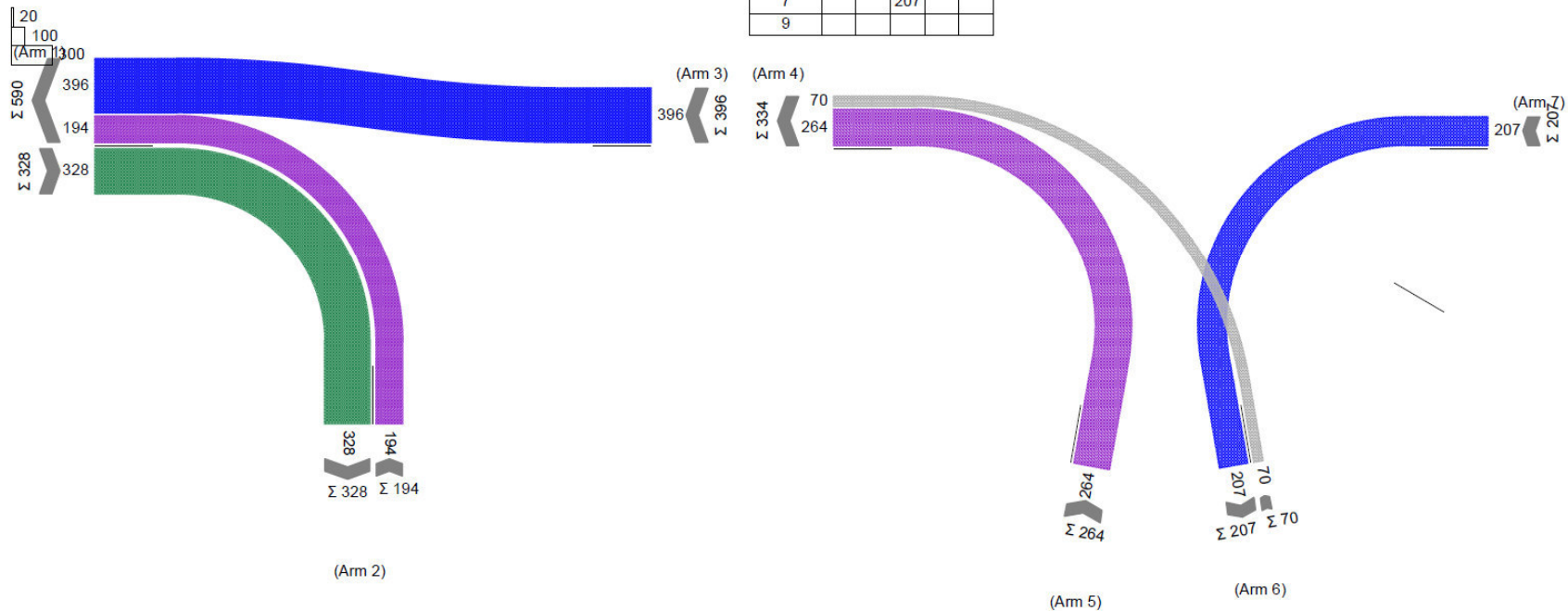



## Leistungsfähigkeiten und Verkehrsqualität

Reiferbahn / Parkplatz Schloßparkcenter ; NSP ;  $T_U = 85 \text{ sec}$

Zuf	Fstr.Nr.	Symbol	SGR	$t_f$ [s]	$t_A$ [s]	$t_s$ [s]	$f_A$	$q$ [Kfz/h]	$m$ [Kfz/U]	$t_b$ [s/Kfz]	$q_s$ [Kfz/h]	$N_{MS,95>NK}$	$n_c$ [Kfz/U]	$C$ [Kfz/h]	$x$	$t_w$ [s]	$N_{GE}$ [Kfz]	$N_{MS}$ [Kfz]	$N_{MS,95}$ [Kfz]	$L_x$ [m]	QSV	Bemerkung	
1	1		K1	55	56	30	0,659	328	7,744	2,016	1786	-	28	1177	0,279	6,731	0,221	3,457	6,602	39,612	A		
2	1		K2	47	48	38	0,565	194	4,581	2,016	1786	-	24	1009	0,192	9,499	0,134	2,369	4,972	29,832	A		
3	1																						
4	1		K6	0	0	85	0,000	0	0,000	2,016	0	-	0	0	-	-	-	-	-	-	-	F	
5	3		K5	12	13	73	0,153	132	3,117	2,016	1786	x								39,216			
	1		K5	12	13	73	0,272	132	3,117	2,016	1786	-	11	485	0,544	31,892	0,735	6,061	10,225	61,350	B		
6	1		K9	11	12	74	0,141	70	1,653	2,016	1786	-	6	252	0,278	35,768	0,219	1,697	3,900	23,400	C		
7	1		K4, K7	22	23	63	0,271	207	4,888	2,016	1786	-	11	484	0,428	28,838	0,442	4,472	8,048	48,288	B		
9	1		K8	0	0	85	0,000	0	0,000	1,800	0	-	0	0	-	-	-	-	-	-	-	F	
Knotenpunktssummen:								1063						3407									
Gewichtete Mittelwerte:																-	-						
				TU = 85 s T = 3600 s																			

C

Die Ströme K6 und K8 blieben wegen geringer Anforderungshäufigkeit unberücksichtigt.



## Verkehrsmengen

Wismarsche Str./Arsenalstr./F.-Mehring-Str., 21.03.2018 - Nachmittagsspitzenstunde in Kfz/h incl. SV

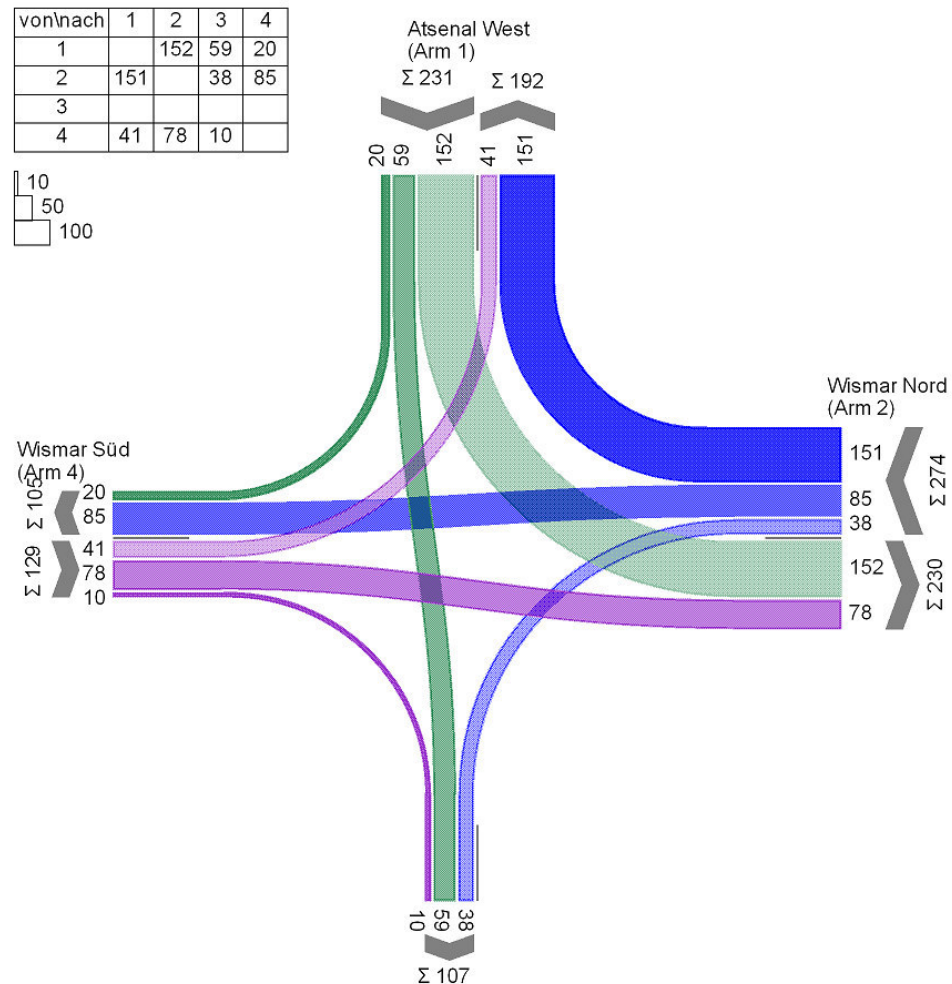



# Leistungsfähigkeiten und Verkehrsqualität

## Wismarsche Str./Arsenalstr./F.-Mehring-Str. ; NSP

Bestand

Arm	Zufahrt	Vorfahrtsregelung	Verkehrsstrom
1	D		Vorfahrt gewähren!
			10
			11
2	C		Vorfahrtsstraße
			7
			8
3	B		Vorfahrt gewähren!
			9
			6
4	A		Vorfahrtsstraße
			1
			2
			3

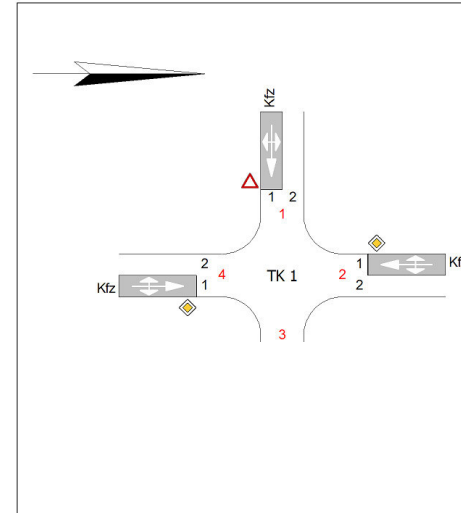

Arm	Zufahrt	Strom	Verkehrsstrom	q <sub>Fz</sub> [Fz/h]	q <sub>PE</sub> [Pkw-E/h]	C <sub>PE</sub> [Pkw-E/h]	C <sub>Fz</sub> [Fz/h]	x <sub>i</sub> [-]	R [Fz/h]	tw [s]	QSV
4	A	4 → 1	1	41,0	44,5	982,5	905,5	0,045	864,5	4,2	A
		4 → 2	2	78,0	84,5	1.800,0	1.662,0	0,047	1.584,0	2,3	A
		4 → 3	3	10,0	10,0	1.600,0	1.600,0	0,006	1.590,0	2,3	A
3	B	-	4	-	-	-	-	-	-	-	-
		-	5	-	-	-	-	-	-	-	-
		3 → 2	6	0,0	0,0	1.084,0	985,5	0,000	985,5	3,7	A
2	C	2 → 3	7	38,0	38,5	1.163,0	1.148,0	0,033	1.110,0	3,2	A
		2 → 4	8	85,0	90,5	1.800,0	1.690,0	0,050	1.605,0	2,2	A
		2 → 1	9	151,0	151,0	1.600,0	1.600,0	0,094	1.449,0	2,5	A
1	D	1 → 2	10	152,0	152,0	664,0	664,0	0,229	512,0	7,0	A
		1 → 3	11	59,0	59,0	630,5	630,5	0,094	571,5	6,3	A
		1 → 4	12	20,0	20,0	986,5	986,5	0,020	966,5	3,7	A
Mischströme											
4	A	-	1+2+3	129,0	139,0	1.800,0	1.670,0	0,077	1.541,0	2,3	A
3	B	-	4+5+6	0,0	0,0	-	-	-	-	-	A
2	C	-	7+8+9	274,0	280,0	1.800,0	1.761,5	0,156	1.487,5	2,4	A
1	D	-	10+11+12	231,0	231,0	673,5	673,5	0,343	442,5	8,1	A
Gesamt QSV											A