



KONGSBERG



AVL

Engine Performance Optimization by Permanent Use of Holistic Expert Condition Monitoring System



Dr. Hinrich Mohr
Dr. Rüdiger Teichmann

AVL List GmbH

Vegard Hansen

Kongsberg Maritime AS



KONGSBERG



AVL

Content of Presentation

- Introduction and Overview
- Requirements for Condition Monitoring Systems
- Concept of AVL EPOS™
- Integration into Kongsberg's Vessel Performance Monitoring
- Field Experiences
- Conclusion and Outlook

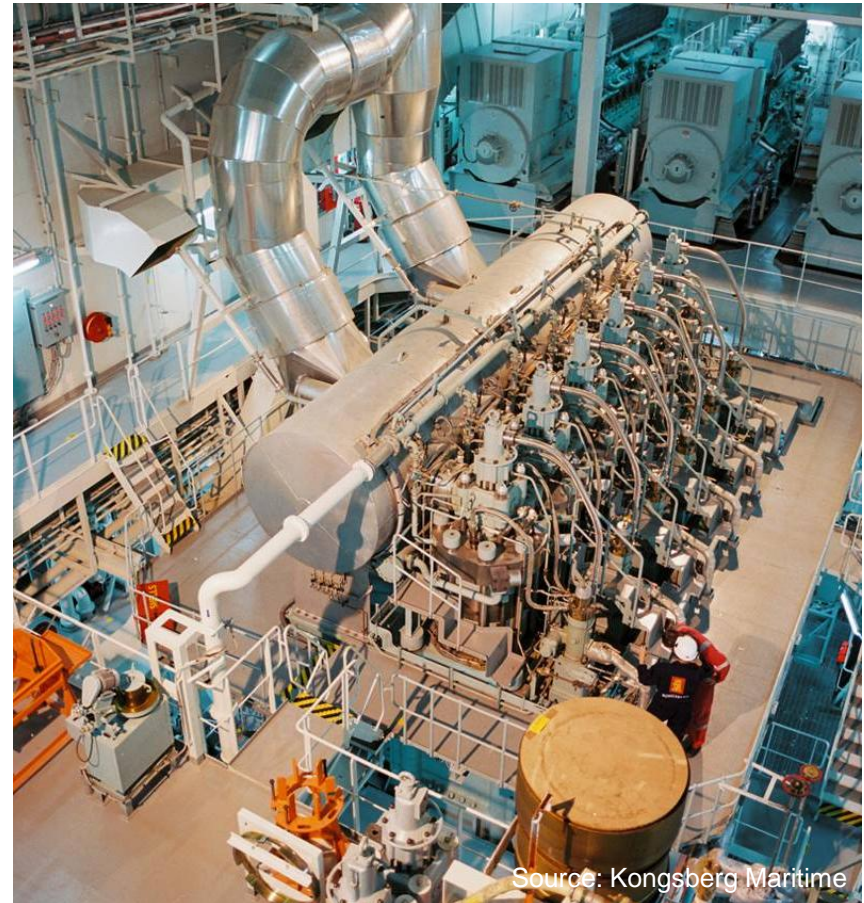



KONGSBERG



AVL

Who is AVL from Graz / Austria?



World's largest privately owned and independent company

for the development of powertrain systems
(combustion engines, hybrid systems, electric drives)
as well as simulation and test systems

Founded 1948

4,500 Employees
worldwide

45 Representations and
affiliates worldwide



KONGSBERG



AVL

AVL covers all Customer Segments



Passenger Cars



2-Wheelers



Racing



Construction



Agriculture



Commercial Vehicle



Locomotive



Marine



Power Plants



Engineering

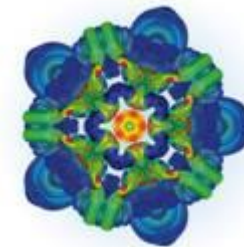

Simulation



Testing

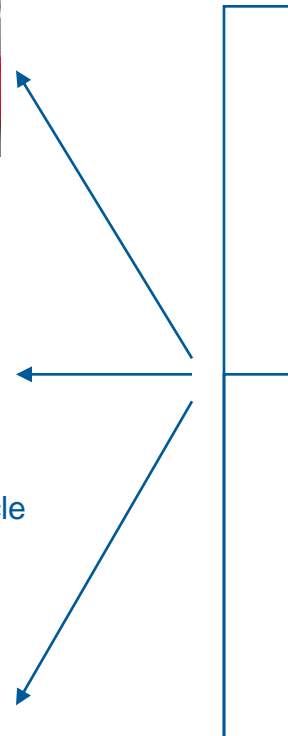



KONGSBERG



AVL

Introduction and Overview

Question out of Book 'Modern System of Naval Architecture':

'how to make her fast before the wind, fast against the wind, fast across the wind, fast when she is deeply loaded, and fast when the sea is smooth, and fast when the sea is rough?'

- statement nowadays still valid for newbuildings and vessels in operation, especially in times of economical crisis
- directly related to efficiency (speed, fuel consumption, emissions)

⇒ key word:

Optimum
Vessel Performance



John Scott Russell, 1865



KONGSBERG



AVL

Introduction and Overview

Kongsberg Vessel Performance System for Merchant Marine Fleet

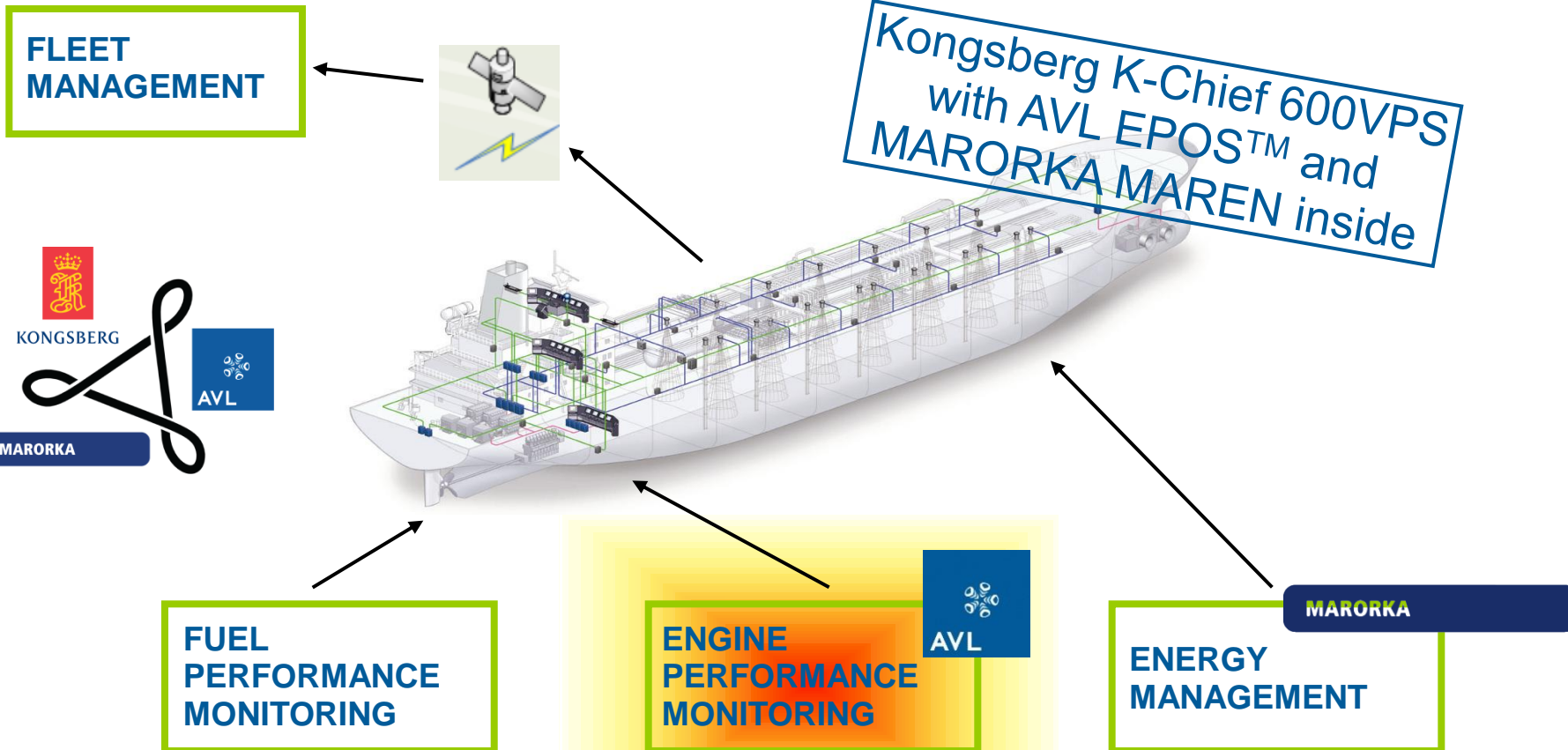



KONGSBERG



AVL

Introduction and Overview

Goal of Engine Performance Monitoring:

Optimum thermodynamical and mechanical engine behaviour leading to low operating costs and high life cycle quality.



⇒ The view has to be set onto the main and auxiliary engines, in particular to:

- combustion
- fuel supply and injection
- turbocharging
- cooling
- lubrication

... as well for the related auxiliary systems



KONGSBERG



AVL

Requirements for Condition Monitoring Systems

- extensive engine expert knowledge in combination with measurement and data evaluation experience as basis for effective and reliable system development evident
- robust system components for long lifetimes under rough operating conditions
- broad interface to alarm and monitoring systems for additional data input
- simple GUI (graphical user interface) for intuitive handling
- effective and operator-configurable data storage
- integration of additional measurement systems possible
- regular and easy data submission to fleet management



Concept of AVL EPOS™ (1)

AVL EPOS™ – the **E**ngine **P**erformance and **O**ptimization **S**ystem

- open diagnosis platform for all kind of IC engines and their auxiliaries
- integrated into Kongsberg Maritime's automation system and vessel performance optimizer for the marine market

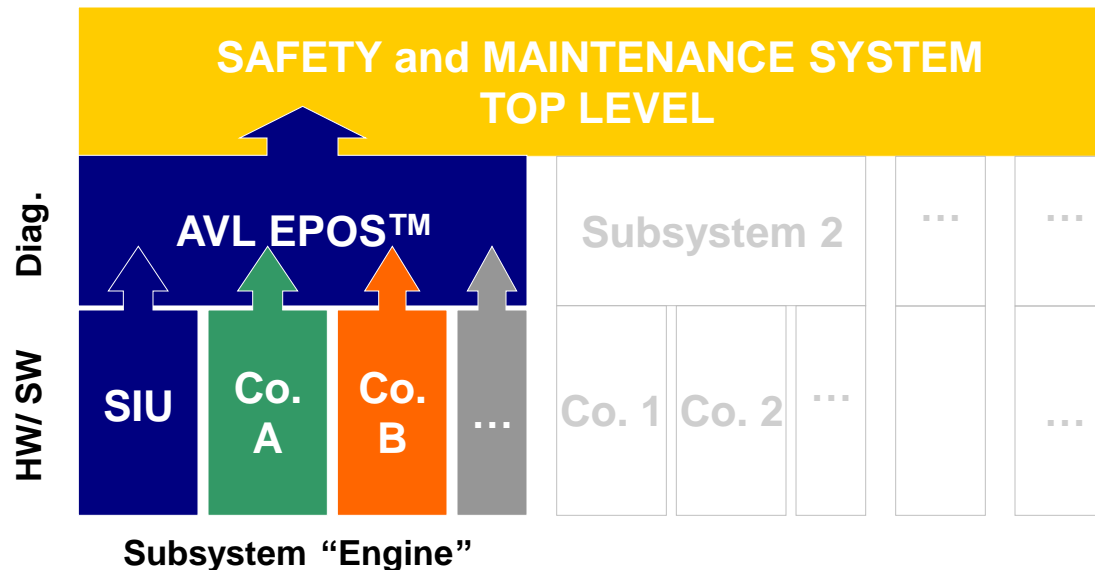



KONGSBERG



AVL

Concept of AVL EPOS™ (2)

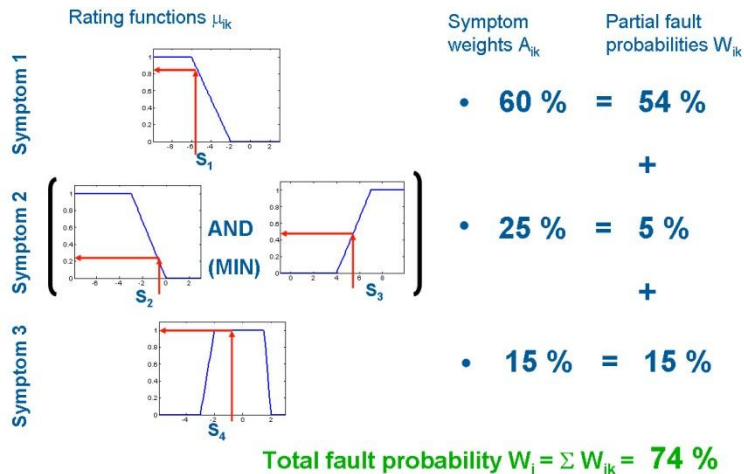
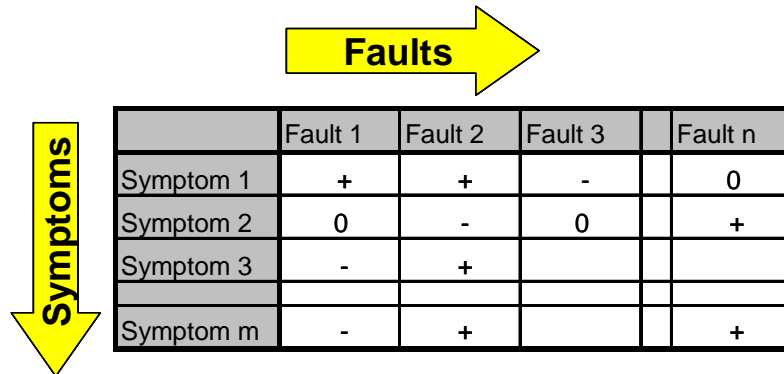

- plausibility check of input signals including sensor modeling
- AVL IndiCom combustion analysis
- extended concept of fault-symptom-pattern, based on field experience
- subsequent algorithms based on upstream data analysis, fuzzy logic and different physical models
- signatures of input signals compared to reference values
- consideration of fault probability and symptom importance
- final status classification of engine, cylinders and subsystems



KONGSBERG



GUI-Concept of AVL EPOS™

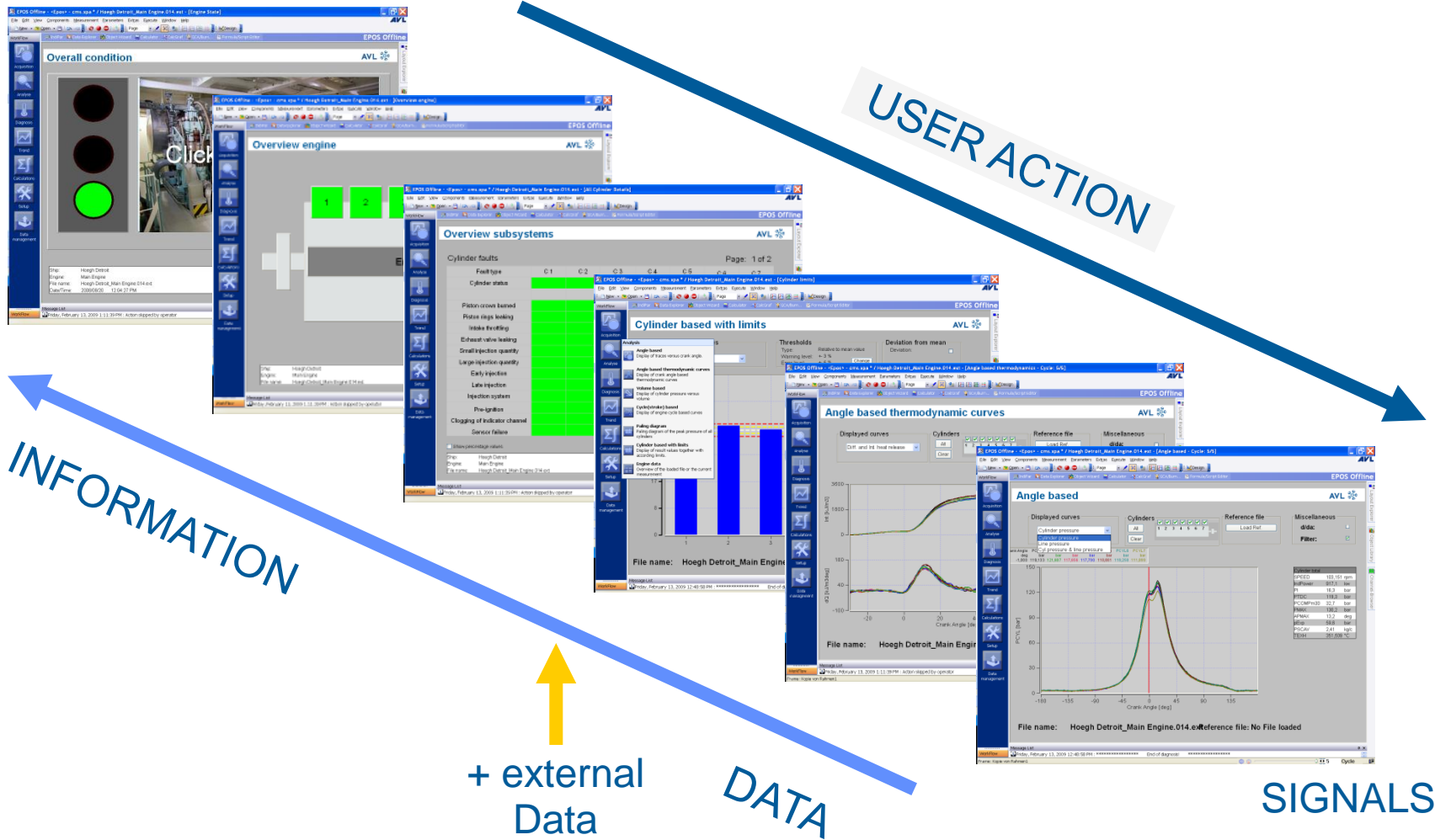



KONGSBERG



AVL

Features of AVL EPOS™

AVL EPOS™ V1.1 includes already

- continuous evaluation and permanent analysis of fuel injection process and combustion process (with AVL GaPO₄ cylinder pressure sensors)
- failure detection by expert algorithms of fuel injection system and combustion chamber area
- trend analysis (chronological, characteristic plot vs. engine load or speed) and trend prediction
- integration of external monitoring devices





KONGSBERG



AVL

Integration into Kongsberg's Vessel Performance Monitoring

- basis of Kongsberg's VPS is K-Chief 600 automation system, using standard modules communicating by dual redundant process network and configurable for all vessel types
- Kongsberg's VPS provides set of tools for optimized ship operation in a more economical and environmentally beneficial way
- full integration of AVL EPOS™ enabling operator's access to important engine performance data 24/7
- seamless flow of data between both systems organized in the background
- AVL EPOS™ results integrated in KC-600 user interface for easy handling, diving into system for increased information possible
- no interference with integrity of automation system



KONGSBERG



Integration into Kongsberg's Vessel Performance Monitoring

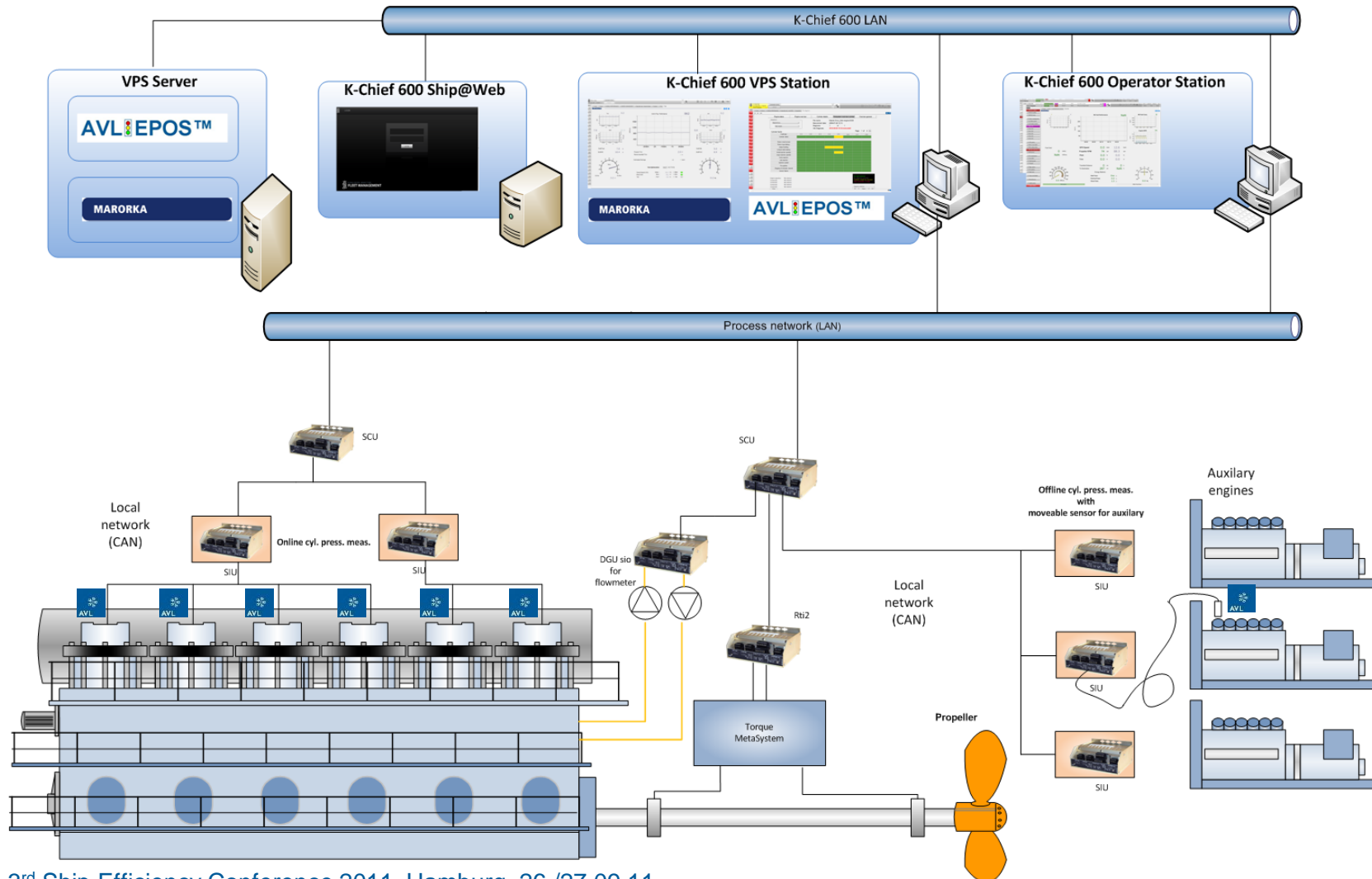



KONGSBERG



Integration into Kongsberg's Vessel Performance Monitoring

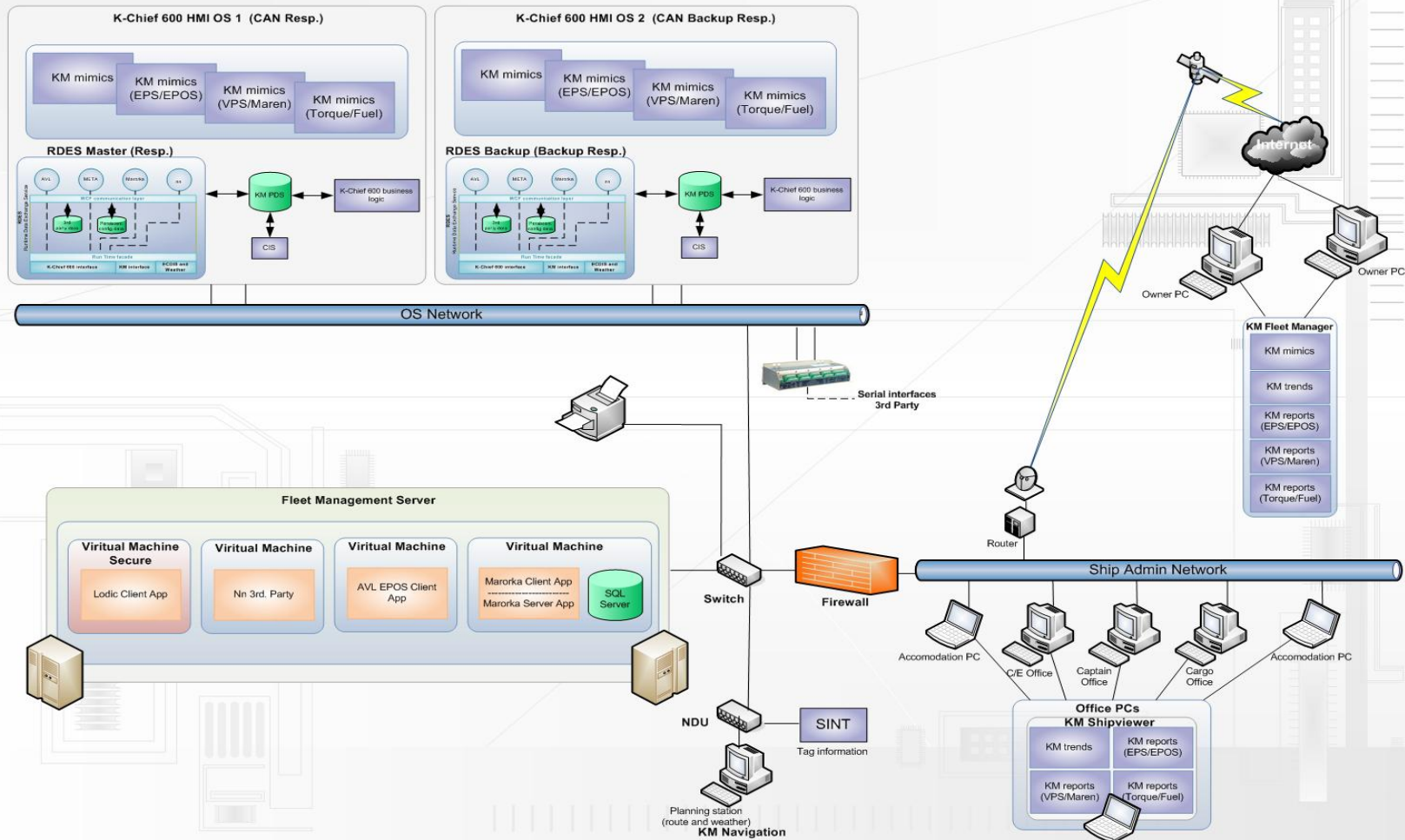



KONGSBERG



AVL

Field Experiences



AVL EPOS™



+ 9 sister vessels





KONGSBERG



Field Experiences – the Sensor as robust Hardware Core

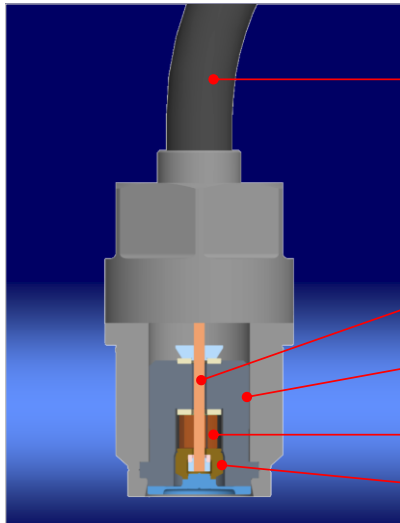

Integrated FPM Cable
integrated Amplifier
(..DA) or Connector for
Standardcable (..DI)

Central Pre-tension
Element

Double Shell Housing
front- (M14) or shoulder sealed (M14 and M10)

GaPO₄ Piezoelements

Leak-proof Konzept (verified)



- extensive positive experiences on HFO-, gas and biofuel engines
- on 2-strokes as well as on 4-strokes

HFO > 15.000 h

Gas > 15.000 h

Biofuel > 15.000 h



KONGSBERG



Field Experiences – the Software as proven Expert Tool

• Example M/E Compression Failure

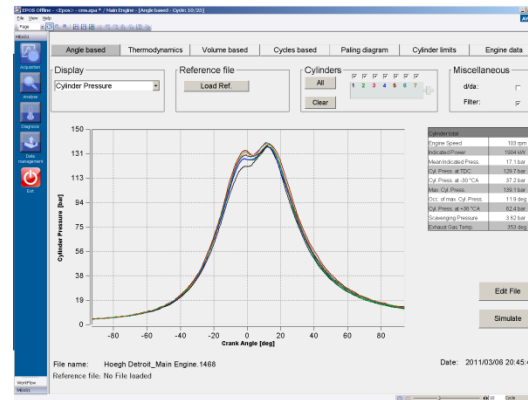
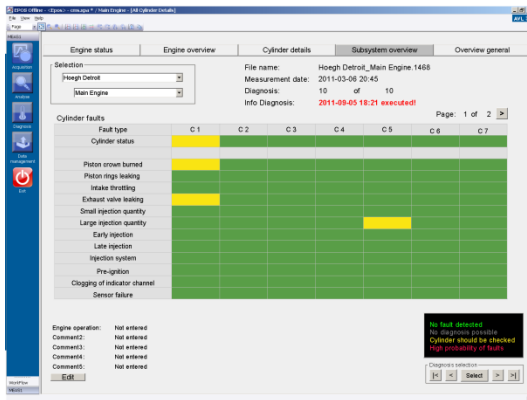

• Example A/E Fuel Injection Pump Failure

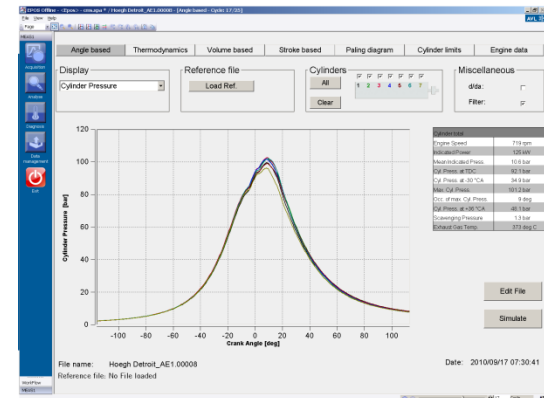
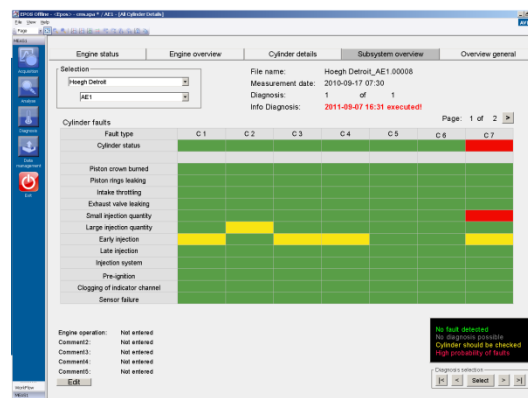
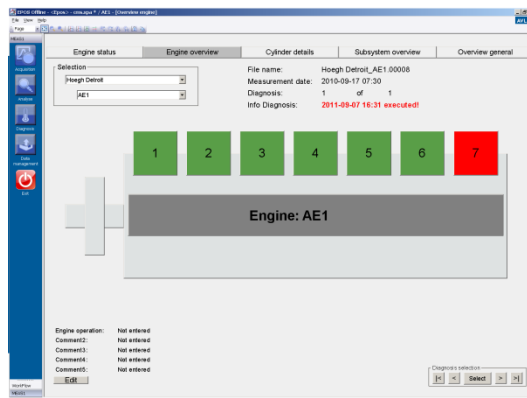



KONGSBERG



AVL

Field Experiences – Installation NITC/Oman Shipping

- Example M/T Seeb

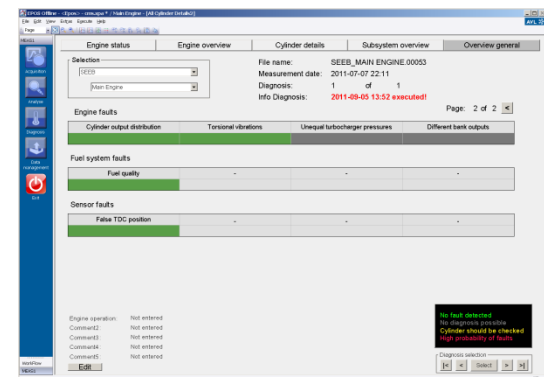
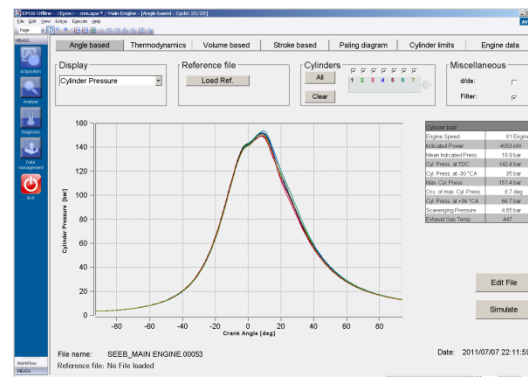
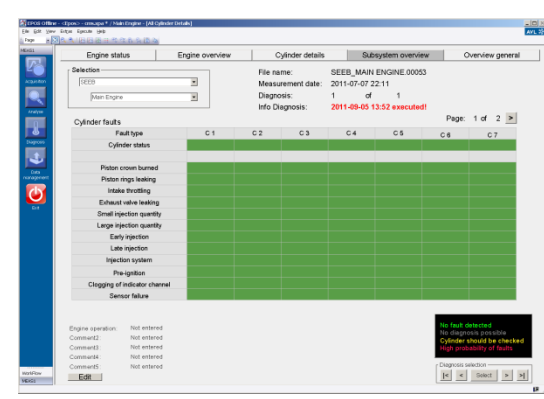
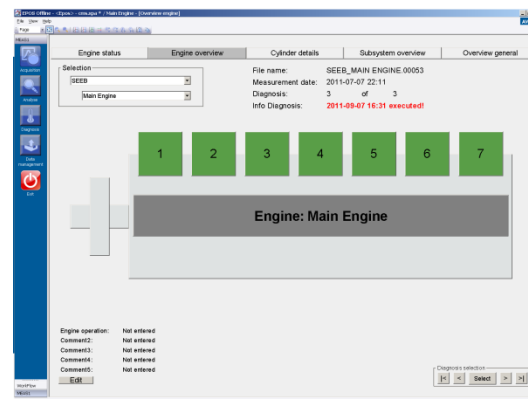
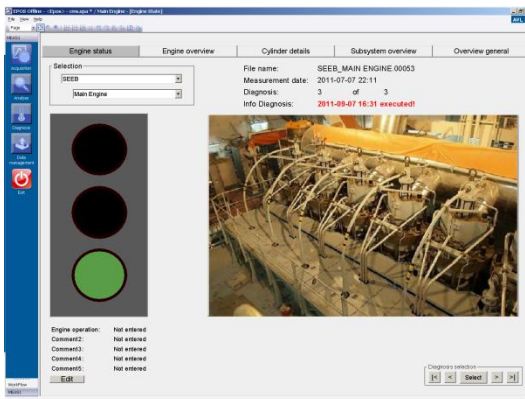



KONGSBERG



AVL

Field Experience – Engine Optimization Impact

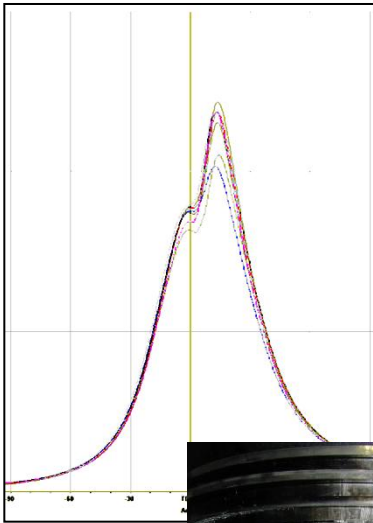

- beside early detection of upcoming faults and avoidance of damages also regularly engine operation optimization possible with AVL EPOS™
- unplanned repair works can be changed to planned maintenance works
- experience show optimization potential up to 3 % efficiency ($\approx 4 \dots 6$ g/kWh) on usual maintained engines, even higher on poor maintained engines (confirmed by MAN Diesel CIMAC publication)
- consequent use of delivered information about engine status enables savings of up to 100.000 US-\$ per year



KONGSBERG



AVL

Conclusion



- CMS for all large-bore engine types and applications
- current version concentrates on combustion and fuel injection expert analysis
- maximum performance reached by integration in KM automation system, stand-alone also available
- trouble-free acting test systems
- vessel operators appreciate independant maker
- consequent system use allows life cycle improvement and savings from optimized engine operation



KONGSBERG



AVL

Outlook



Current development activities:

- thermodynamic and vibration turbocharger monitoring
- online NO_x modelling as well as SO_x and CO₂ calculation
- prediction of engine component behaviour
- improved hardware diagnosis to ensure high signal reliability

Further topics are in the pipeline ...