

# Switzerland



**.22 Box-ID**  
**.22 Boxes of the World**

Created and Edited By  
Roger E. Huegel

2013



Map and flag from Wikipedia.org

# SWITZERLAND

## INTRODUCTION

The Swiss Confederation is located in central Europe north of Italy and south of Germany. It has an area of 15,940 sq. miles. It has a population of 8 million as of 2012. The capital is Bern. The economy centers around a well developed manufacturing industry of machinery, chemicals, watches and clocks. The Swiss are major exporters of many products, including guns. Modern Switzerland dates its history back to 1815, however the history of the Swiss predates any written history.

The Swiss have been producing .22s for their own use for many years, with production ceasing about 1979. The Swiss are a nation of shooters and the .22 has provided them not only a military training loading, but a sporting round as well. While the Swiss have exported guns, they never seem to have a major exporter of ammunition, including .22s.



**EIDG. MUNITIONSFABRIK THUN.** Established in 1863, this is the only producer of .22s in Switzerland. They have produced .22s for both sporting purposes and the Swiss military. Located in Thun with both offices and manufacturing there. They seem to have produced .22s from the 1920s until approximately 1979. The current requirements for .22s are being produced under subcontract of importers.

**J. STAHEL.** This manufacturer produced rimfires in Zurich sometime prior to 1918. Their history is not known at this time.

# SWITZERLAND

## HEADSTAMPS (h/s)

*Headstamp drawings courtesy of the RIMFIRE HEADSTAMP GUIDE by George Kass*

7-9	7-10
	

## THANKS

Special thanks to the following collectors for helping me with this project by supplying me with box images and sharing their knowledge. Presented in alphabetical order.

BERNARD CHEVALIER

ALEX DIEHL

GERARD DUTTON

MANFRED GRUTZNER

JERRY HANEWINCKEL

GEORGE KASS

RON MERCHANT

GÉRARD MOUGIN

RICH RAINS

CURTIS STEINHAUER

ERIC WARD

# SWITZERLAND

## EDDG. MUNITIONFABRIK THUN Early Issues

S-1



S-2



S-3



S-4



S-5



# SWITZERLAND

## EDDG. MUNITIONFABRIK THUN Early Issues

These boxes should have been produced prior to World War II. It is not known when Thun first produced .22s.

S-1 .22 **SHORT**. "No. 2". Cream colored label with red printing. Green, two-piece box with a slip in tray. Yellow side sealing label with black printing "7-9" h/s on a copper case. Lead bullets. Date stamps from 21 3 24 to 6 3 29 noted. Also one box with a code of T1127 noted.

S-2 .22 **SHORT**. Same as S-1 except the top has been over-stamped VERSTARK LADUNG, in place of the date stamps. "7-10" h/s on a copper case. Lead bullets.



S-3 .22 **SHORT**. Same as S-1 except the top over-stamped UMGEPETIET in blue ink. Contents are unknown.

S-4 .22 **SHORT**. "No. 2". Same as S-1 except over-stamped "Für largen Drall"..Contents unknown.

S-5 .22 **SHORT**. "No. 2". S-1 label on a Long pill box style box. TU813 Date stamp on top. Contents unknown.



S-5.5 .22 **SHORT**. "No. 2". Same as S-5 but over-stamped MAYOR LAUSANNE on the top and bottom

### S-5.5



# SWITZERLAND

## EDDG. MUNITIONFABRIK THUN Early Issues

All boxes below have this bottom.



S-6



S-7



S-8



S-9



S-10



S-11



# SWITZERLAND

## EDDG. MUNITIONFABRIK THUN Early Issues

More examples of S-1 style box with examples of different date stamps on top.

S-6 .22 **SHORT.** "No. 2". Same as S-1 except 28.9.28 date stamp

S-7 .22 **SHORT.** "No. 2". Same as S-1 except 21.3.24date stamp

S-8 .22 **SHORT.** "No. 2". Same as S-1 except TD126 date stamp

S-9 .22 **SHORT.** "No. 2". Same as S-1 except T1127 date stamp

S-10 .22 **SHORT.** "No. 2". Same as S-1 except TD310date stamp

S-11 ..22 **SHORT.** "No. 2". Same as S-1 except 6.3.29date stamp



# SWITZERLAND

## EDDG. MUNITIONFABRIK THUN Early Issues

L-1



LR-1



XL-1





# SWITZERLAND

## EDDG. MUNITIONFABRIK THUN Early Issues

L-1 **.22 LONG.** "No. 3" Cream colored label with black printing. Green, Two-piece box with a slip in tray. Cream colored side sealing label with black printing. Contents are unknown

LR-1 **.22 LONG RIFLE.** "No. 6". Yellow label with black printing Green, two-piece box with a slip in tray. Yellow side sealing label with black printing. "7-9" h/s on a copper case. Lead bullets. Dates from 26 10 24 to T1227 noted.



XL-1 **.22 EXTRA LONG.** "NO. 7". Blue green label with white printing. Buff, two-piece box, half-split. "7-9" h/s on a copper case with heavy crimps. Lead bullets. Codes T1021 and To611.



# SWITZERLAND

## EDDG. MUNITIONFABRIK THUN No. 2 Middle Issues

S-1

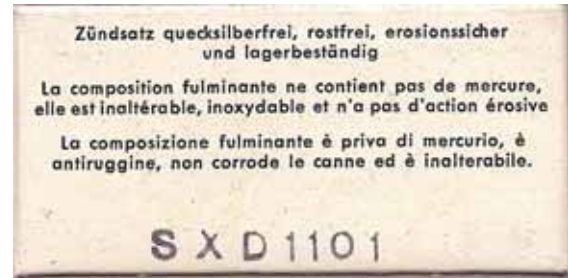

S-2



S-3



S-4



# SWITZERLAND

## EDDG. MUNITIONFABRIK THUN No. 2 Middle Issues

The dates of production of these issues are not known at this time but they could have been introduced as early as the 1940s. They seem to have remained in production until the 1970s.

S-1 **.22 SHORT.** "No. 2". Yellow and red box with black and red printing. Large, one-piece box with end flaps. Copper case. Lead bullets. Variations noted:

- (a) "7-9" h/s.
- (b) "7-10" h/s.



S-2 **.22 SHORT.** White box with black printing. "7-9" h/s on a copper case. Lead bullet



S-3 **.22 SHORT.** "FUR SELBSTLADEWAFFEN= For **AUTOMATIC WEAPONS**". Yellow and red box with black, red and green printing. Large, one-piece box with end flaps. Contents are unknown. This is a loading for single shot guns.



S-4 **.22 SHORT (DUMMY).** "MANIPULIER". Yellow and red box with black printing. Large, one-piece box with end flaps. A white label with red printing has been added to the top. "7-9" h/s on a copper case with a hole in the side. Lead bullets.



# SWITZERLAND

## EDDG. MUNITIONFABRIK THUN No. 2 Middle Issues

S-5



S-6



S-7

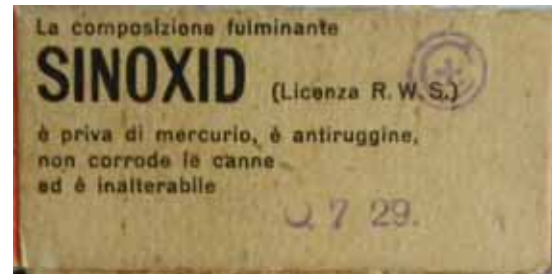

S-8



# SWITZERLAND

## EDDG. MUNITIONFABRIK THUN No. 2 Middle Issues

- S-5 .22 SHORT. "No. 2". Yellow and red box with black and red printing.  
Large, one-piece box with end flaps. No large 2 on top. Contents unknown



- S-6 .22 SHORT. "No. 2". Yellow and red box with black and red printing.  
Large, one-piece box with end flaps. No large 2 on top. Top states:  
"AUSFUHR VERBOTEN (EXPORT FORBIDDEN)". Contents unknown

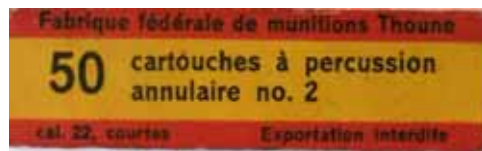

- S-7 .22 SHORT. "No. 2". Same as S-6 but slightly different side.

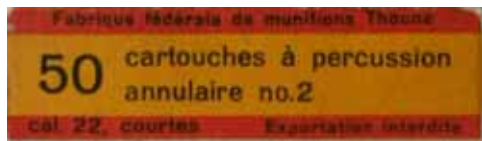

- S-8 .22 SHORT. "No. 2". S-6 box with over-label. Contents unknown.



# SWITZERLAND

## EDDG. MUNITIONFABRIK THUN No. 3 Middle Issues

L-1

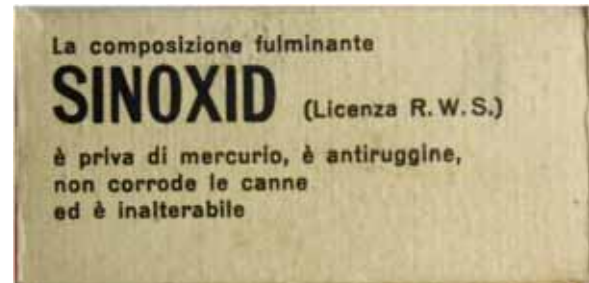

# SWITZERLAND

## EDDG. MUNITIONFABRIK THUN No. 3 Middle Issues

L-1 .22 LONG. "No. 3". Yellow and red box with black and red printing. Large, one-piece box with end flaps. No large 2 on top. Top states: "AUSFUHR VERBOTEN (EXPORT FORBIDDEN)". Contents unknown





# SWITZERLAND

## EDDG. MUNITIONFABRIK THUN No. 6 Middle Issues

LR-1



LR-2

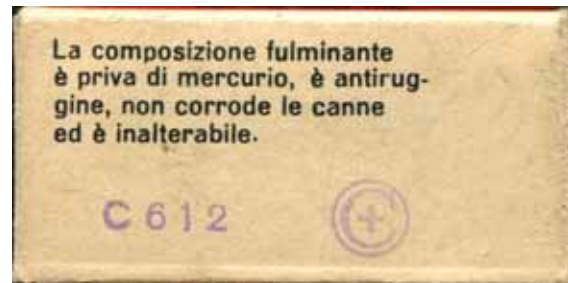

LR-3

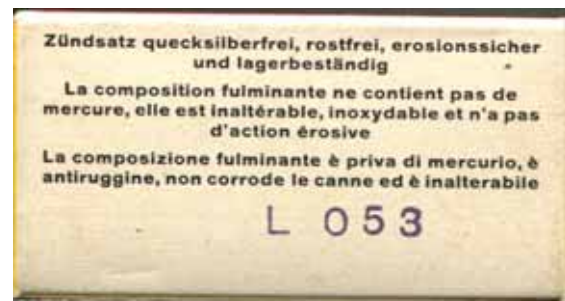

LR-4

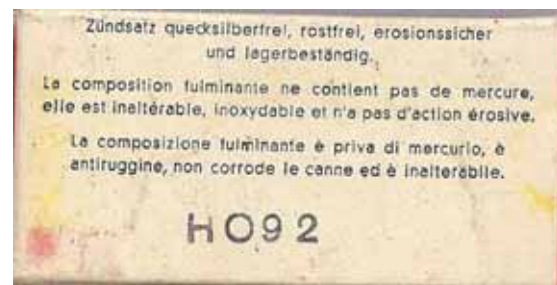

# SWITZERLAND

## EDDG. MUNITIONFABRIK THUN No. 6 Middle Issues

- LR-1 **.22 LONG RIFLE.** "Nr.. 6". Red, white and yellow box with black printing: Large, one-piece box with end flaps. Red and yellow side sealing label with black printing. Side states "Exportation interdite" ([Export prohibited](#)). Contents unknown.



- LR-2 **.22 LONG RIFLE.** "Nr.. 6". Red, white and yellow box with black printing: Large, one-piece box with end flaps. Red and yellow side sealing label with black printing. "7-9" h/s on a copper case. Lead bullets.

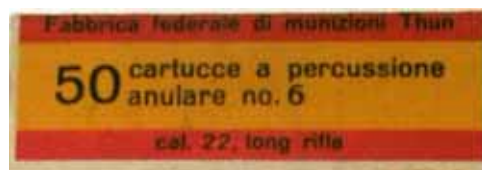

- LR-3 **.22 LONG RIFLE. (MATCH).** "Nr. 6". Red, white, and yellow box with black printing. Large, one-piece box with end flaps. Contents are unknown.

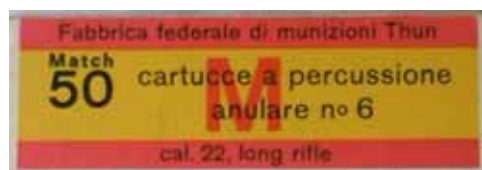

- LR-4 **.22 LONG RIFLE.** "Nr.. 6". Red, white and yellow box with black printing: Large, one-piece box with end flaps. Variations noted:  
(a) "7-9" h/s on a copper case. Red and yellow ends to box.  
(b) Same as (a) except a drawing of Mount Matterhorn on end.  
(c) "7-10" h/s on a brass case. Cardboard tray.  
(d) Same as (c) except a plastic tray.



# SWITZERLAND

## EDDG. MUNITIONFABRIK THUN No. 6 Middle Issues

LR-5



LR-6

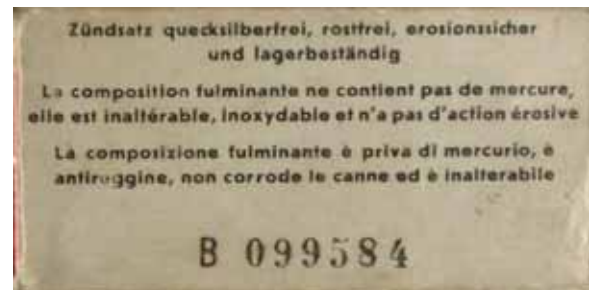

LR-7

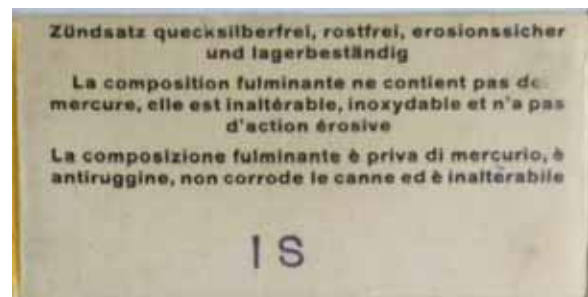

LR-8





# SWITZERLAND

## EDDG. MUNITIONFABRIK THUN No. 6 Middle Issues

LR-5 **.22 LONG RIFLE.** Another variation of LR-4 with a slightly different format to the top text line length and font thickness. Sides and ends are different. Contents unknown.

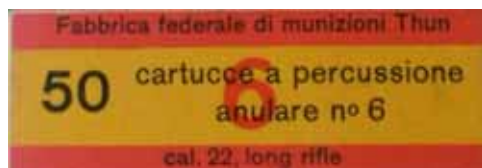

LR-6 **.22 LONG RIFLE.** Another variation of LR-4 and LR-5 with a slightly different font thickness. Sides and ends are different. Contents unknown.



LR-7 **.22 LONG RIFLE (MATCH).** "Nr.. 6". Red, white and yellow box with black printing: Large, one-piece box with end flaps. Red and yellow side sealing label with black printing. "7-9" h/s on a copper case. Lead bullets.



LR-6 **.22 LONG RIFLE (DUMMY).** "MANIPULIER". LR-2 box with white over-label with red printing. Contents unknown.

# SWITZERLAND

## EDDG. MUNITIONFABRIK THUN No. 7 Middle Issues

XL-1

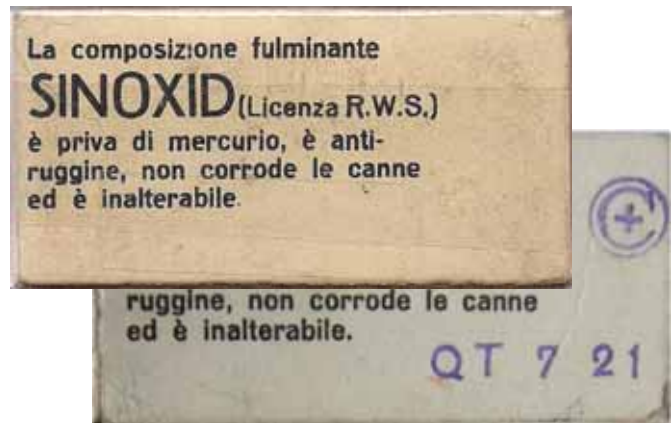

XL-2

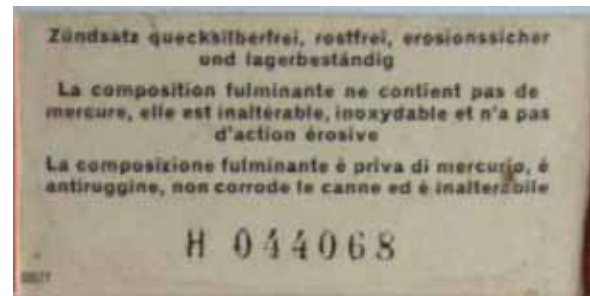

XL-2.5

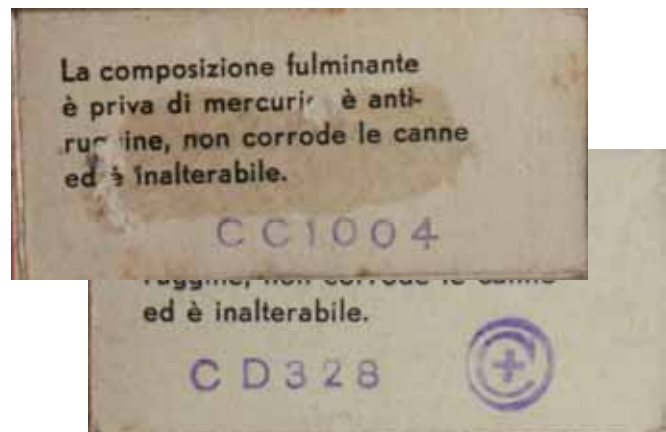

XL-3



# SWITZERLAND

## EDDG. MUNITIONFABRIK THUN No. 7 Middle Issues

XL-1 **.22 EXTRA LONG.** "No. 7". Yellow and blue box with black printing. Large, one-piece box with end flaps. Yellow and blue side sealing label with black printing. "7-9" h/s on a copper case. Lead bullets.



XL-2 **.22 EXTRA LONG.** "Nr. 7". Yellow and red box with black printing. Large, one-piece box with end flaps. No side sealing label. "7-9" h/s on a copper case. Lead bullets.



XL-2.5 **.22 EXTRA LONG.** "Nr. 7". Same as XL-2 but different ends and bottoms.



XL-3 **.22 EXTRA LONG.** "No. 7". Same as XL-1 except the different fonts. And bottom.



XL-4 **.22 EXTRA LONG.** "No. 7". Blue and yellow box with black printing. Large, one-piece box with end flaps. Note the CAL. 22, EXTRA LANG is now in the yellow part of the top in place in the red. "7-9" h/s on a copper case. Lead bullet.



### XI-4





# SWITZERLAND

## EDDG. MUNITIONFABRIK THUN No. 7 Middle Issues

XL-5



XL-6

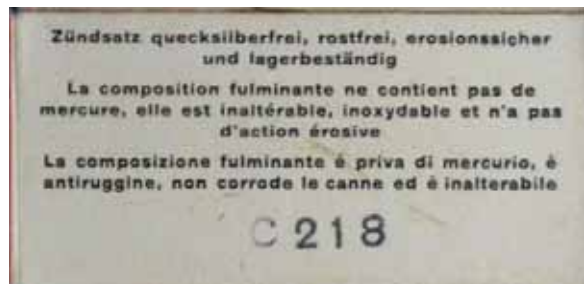

XL-7

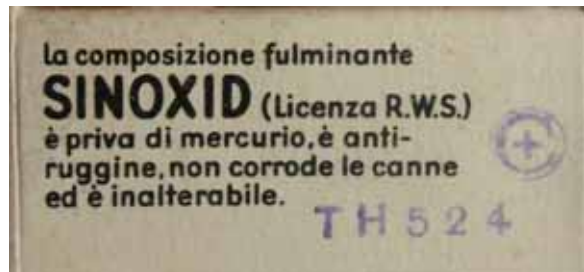

XL-9

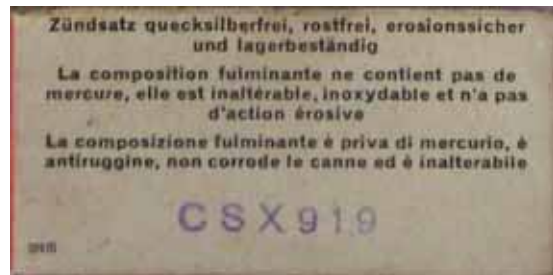



# SWITZERLAND

## EDDG. MUNITIONFABRIK THUN No. 7 Middle Issues

XL-5 **.22 EXTRA LONG (DUMMY).** "MANIPULIER". Same as XL-2 except for a white label with red ink added to the top. "7-9" h/s on copper cases with a hole in the side. Lead bullet



XL-6 **.22 EXTRA LONG.** "No. 7". Red, white and yellow box with black printing: Large, one-piece box with end flaps. Contents unknown.

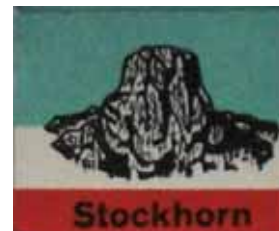

XL-7 **.22 EXTRA LONG.** "No. 7". Yellow and blue box with black printing. Large, one-piece box with end flaps. Much bolder font and different 7.



XL-8 **.22 EXTRA LONG.** "No. 7". Yellow and blue box with black printing. Large, one-piece box with end flaps. The "o" in No. is different.



XL-9 **.22 EXTRA LONG. (BLANK)** "No. 7". XL-1 box with two white over-labels stating Markierpatronen (simulating cartridge). Rose-crimped copper case.

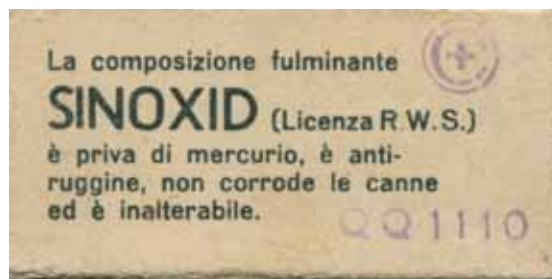

# SWITZERLAND

## EDDG. MUNITIONFABRIK THUN No. 8 Middle Issues

LR-1



LR-2



LR-3

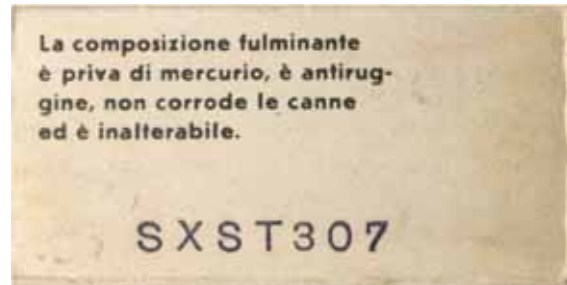

# SWITZERLAND

## EDDG. MUNITIONFABRIK THUN No. 8 Middle Issues

- LR-1 **.22 LONG RIFLE.** "FUR SELBSTLADEWAFFEN (FOR AUTOMATIC WEAPONS)". Green and red box with red and black printing. Large, one-piece box with end flaps. "7-9" h/s on a nickel washed brass case, Lead bullet. Code No. 8 on the top.
- LR-2 **.22 LONG RIFLE (DUMMY).** "MANIPULIER". Green. and red box with black printing. A white label with red printing has been added to the top. Large, one-piece box with end flaps. "7-9" h/s on a nickel washed brass case with a hole in the side. Lead bullets.
- LR-3 **.22 LONG RIFLE.** "FUR SELBSTLADEWAFFEN (FOR AUTOMATIC WEAPONS)". Green and red box with red and black printing. Large, one-piece box with end flaps. Over-stamped VERSUCH.(EXPERIMENTAL). Code No. 8 on the top.



# SWITZERLAND

## EDDG. MUNITIONFABRIK THUN Misc. Middle Issues

XL-11

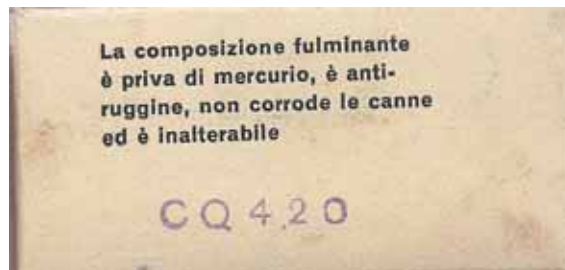

*H=10:1*  
*Detail von "B"*

*Ansicht des Bodens*  
*N° 1 ce 41 mm vertica*

**Zündsele Mischung:**

- 5% Tetrazol
- 50% Triazol
- 23% Bariumnitrat
- 5% Bleisuperoxyd
- 5% Schwefelantimon
- 2% Glaspulver

*Gewicht der Patronenhülse  
gepresst und angefeuert: ca. 0,900g*

*Gewicht des Zündsatzes: 0,045<sup>±0,005</sup>g*

**Ungiftig**  
ersetzt durch: T4373

1	Abschlusscheibchen	3	Wesepapier	T 14626	Dicke gepresst 0,1 mm
-	Zündsatz (Sinoxid)	2	-	-	-
1	Hülse, Fertigung	1	Tamok	T 35942	-
Stk.	Gegenstand	Pos.	Material	Z. Nr.	Bemerkung
<b>Verwendung:</b>					Ersetzt durch Z.Nr. T 4373
Für Nischen, Winter-Mur, Viehsicherungsmunition, Standfeuerpatronenhüllen					Ersetzt für Z.Nr. T 34882
<b>Patronenhülse</b>					Massstab
					5:1
Eidg. Munitionsfabrik Thun					Z.Nr. T 35941



# SWITZERLAND

## EDDG. MUNITIONFABRIK THUN Misc. Middle Issues

XL-1 .22 EXTRA LONG (TRAINING). "No. 66". White and red box with black printing. Large, one-piece box with end flaps. "7-9" h/s on a brass case. Round lead bullet.

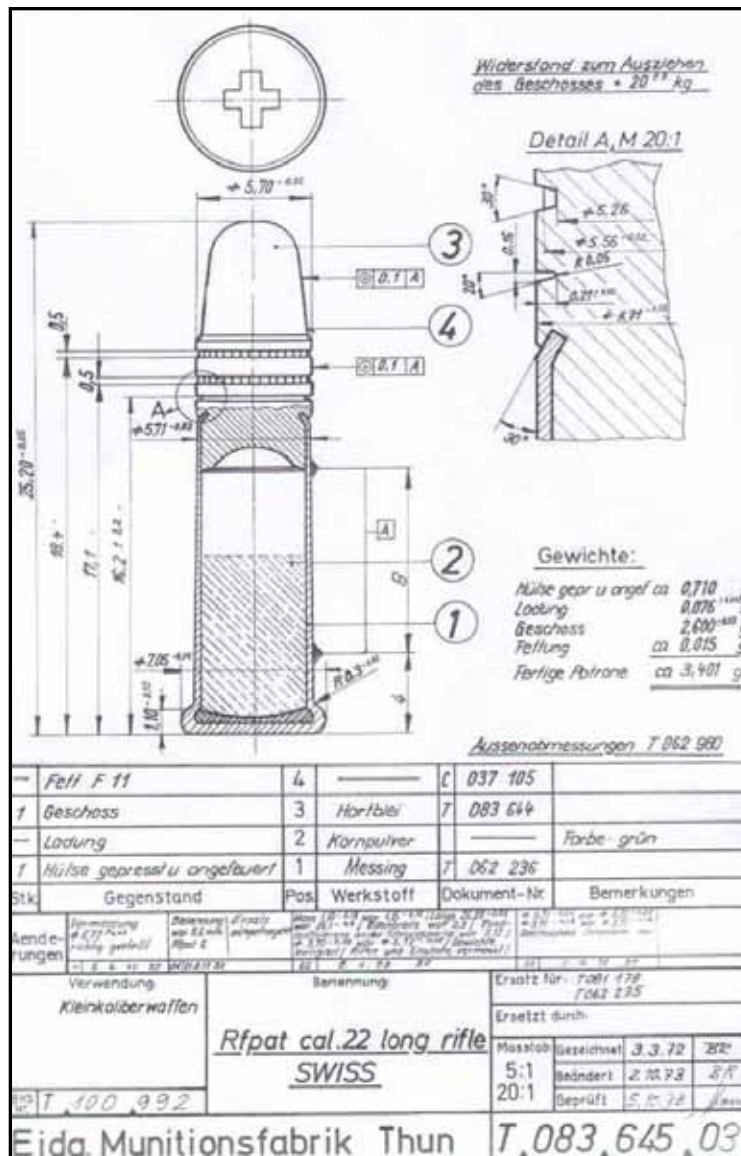

# SWITZERLAND

## EDDG. MUNITIONFABRIK THUN

Late Issues

LR-1



LR-2



LR-3



LR-4



# SWITZERLAND

## EDDG. MUNITIONFABRIK THUN Late Issues

These are the last issues produced by Thun and were probably produced in the late 1970s and early 1980s. These boxes may have been special boxes for target shooting.

LR-1 **.22 LONG RIFLE. (STANDARD VELOCITY). "STANDARD".** Black box with white, blue and black printing. Large, one-piece box with end flaps. Code 159-79T on bottom. Contents unknown.



LR-2 **.22 LONG RIFLE. (STANDARD VELOCITY). "STANDARD".** Same as LR-1 except white, black and red printing. "7-10" h/s on a copper case. Lead bullets. Variations noted:  
(a) Code 202-78T on the bottom.  
(b) No code on the bottom.



LR-3 **.22 LONG RIFLE. "TRAINING".** Black box with yellow, white and black printing. Large, one-piece box with end flaps. No code on the bottom. Contents are unknown.



LR-4 **.22 LONG RIFLE. "TRAINING".** Same as LR-3 except red, white and black printing. Code 091-74T on the bottom.





# SWITZERLAND

## EDDG. MUNITIONFABRIK THUN

Late Issues

LR-5



LR-6



LR-7



LR-8

# SWITZERLAND

## EDDG. MUNITIONFABRIK THUN Late Issues

LR-5 **.22 LONG RIFLE (TARGET), "MATCH".** Black box with red, white and black printing. Large, one-piece box with end flaps. Code 530-76T on the bottom. "7-10" h/s on a brass case. Lead bullets.



LR-6 **.22 LONG RIFLE (TARGET).** Same as LR-1 except a over-pack of two boxes for the SCHUTZEN 1977.

LR-7 **.22 LONG RIFLE (TARGET).** Same as LR-5 except a over-pack of two boxes for the SCHUTZAN 1977.

# SWITZERLAND

## EDDG. MUNITIONFABRIK THUN Late Military Issues

LR-1



LR-2



LR-2.5



# SWITZERLAND

## EDDG. MUNITIONFABRIK THUN Late Military Issues

Thun produced .22s for both sporting and military uses. However, it was not until the later production period that a special packaging for military loadings was used.

- LR-1 **.22 LONG RIFLE (MILITARY)**. White label with black printing. Kraft colored, two-piece, full cover box. Contents are unknown. This box was manufactured by I.M.I. of England for the Swiss military. This would give an indication of the end of .22 production by Thun as being about 1979 as this seems to be a contract loadings after the Thun production ceased.
- LR-2 **.22 LONG RIFLE (MILITARY)**. Kraft carton with end flaps and with a pull tab made of cloth."7-9" h/s on a copper case. Lead bullets. The rounds are linked together in a cloth machinegun belt. Box of 100.
- (a) Green label
  - (b) Cream label



- LR-2.5 **.22 LONG RIFLE (MILITARY)**. Similar to LR-2 but different font sizes.



# SWITZERLAND

## EDDG. MUNITIONFABRIK THUN Late Military Issues

LR-3



LR-3.5



# SWITZERLAND

## EDDG. MUNITIONFABRIK THUN Late Military Issues

LR-3 **.22 LONG RIFLE (MILITARY)**. White and green label with black printing. Kraft colored carton with end flaps. Partial wrap-around label. "7-9" h/s on a copper case. Lead bullets. The rounds are linked together in a white cloth machinegun belt. Box of 100.. 2 examples shown.

LR-3.5 **.22 LONG RIFLE (MILITARY)**. Similar to LR-3 but 594-7010 in larger font.



# SWITZERLAND

## Swiss Imports Misc. Issues

LR-1



LR-2





# SWITZERLAND

## Swiss Imports Misc. Issues

- LR-1 **.22 LONG RIFLE** . “ELEY UNIVERSAL”. White label with black and red printing. Black plastic box. “E-24” h/s on brass case Lead round-nose bullet. Product code 3112-30140  
NOTE: Sold only in Switzerland.



- LR-2 **.22 LONG RIFLE** . “RWS—SPECIAL STOCKHORN”. Light gray one-piece box with black, red and white printing “R-10” h/s on brass case Lead round-nose bullet. Product code 231 76 91.  
NOTE: Made in Germany. Sold only in Switzerland.

