



**Industrial Lines
for the production
of dry baked goods**

WP BAKERYGROUP

WP BAKERYGROUP is the company for bakers. Our comprehensive range of high-quality machines and equipment is aimed at the requirements of bakeries worldwide. We provide baking technology for every step in the process – starting with kneading, dividing & moulding, through to proving & refrigerating and finally baking in both production and shop environments.

Our motto is **'think process!'**. Because only when all the separate processes are perfectly in tune with one another, is it possible to achieve consistently high quality and cost-effectiveness.

- Measurable energy savings
- Less waste
- Higher productivity
- Very simple machine operation
- Reproducible product quality

Day after day

think process!

 Werner & Pfleiderer
Bakery Technologies

 Haton

 Werner & Pfleiderer
Industrial Bakery Technologies

 Kemper

 Werner & Pfleiderer
Bakery Cooling

 Winkler

 Werner & Pfleiderer
Instore Baking

 BackNet
Bakery Software

 Werner & Pfleiderer
Bakery Service

WP CompetenceCenter

- _ Mixing.** Emil Kemper GmbH, Rietberg
- _ Dividing & moulding Rolls.** Emil Kemper GmbH, Rietberg
- _ Dividing & moulding Bread.** Werner & Pfleiderer Haton B.V., NL-Panningen
- _ Baking.** Werner & Pfleiderer Lebensmitteltechnik GmbH, Dinkelsbühl
- _ In-store baking.** Werner & Pfleiderer Lebensmitteltechnik GmbH, Dinkelsbühl
- _ Proofing & Cooling.** Werner & Pfleiderer Lebensmitteltechnik GmbH, Dinkelsbühl
- _ Laminating.** Werner & Pfleiderer Industrielle Backtechnik GmbH, Tamm
- _ Engineering.** Werner & Pfleiderer Industrielle Backtechnik GmbH, Tamm
- _ Bakery software.** BackNet E&S GmbH, Muggensturm

www.wpbakerygroup.com



WP BAKERYGROUP



INDUSTRIAL LINES

*The professional development, manufacture, installation and maintenance of industrial lines for the production of baked goods requires in-depth knowledge and many years of experience. High performance multi-shift production, consistently high product quality, state-of-the-art control systems, challenging hygiene standards and short cleaning and maintenance times are key requirements for modern plant concepts. Requirements the individual companies of the **WP BAKERY GROUP** are definitely able to meet. Based on this background we supply individually equipped industrial lines that are acknowledged worldwide for their reliability.*



Werner & Pfleiderer Industrial Bakery Technologies – For more than 125 years we have developed, projected, manufactured, installed and maintained industrial machines and equipment for the production of baked goods. Today, we have become one of the leading suppliers of highly automated concepts for the continuous production of different types of products - from dough production to conveying of the baked goods and automated packaging. Our core activity within the **WP BAKERYGROUP** are “industrial solutions”. Our product portfolio includes industrial lines for the production of bread and rolls, hard and soft biscuits, soft pretzels, crispbread, rusk, cakes, croutons, breadcrumbs, ...

We supply technical solutions that meet highest expectations. In close cooperation with our clients we develop concepts that comply with the market requirements or are setting future trends in industrial production.

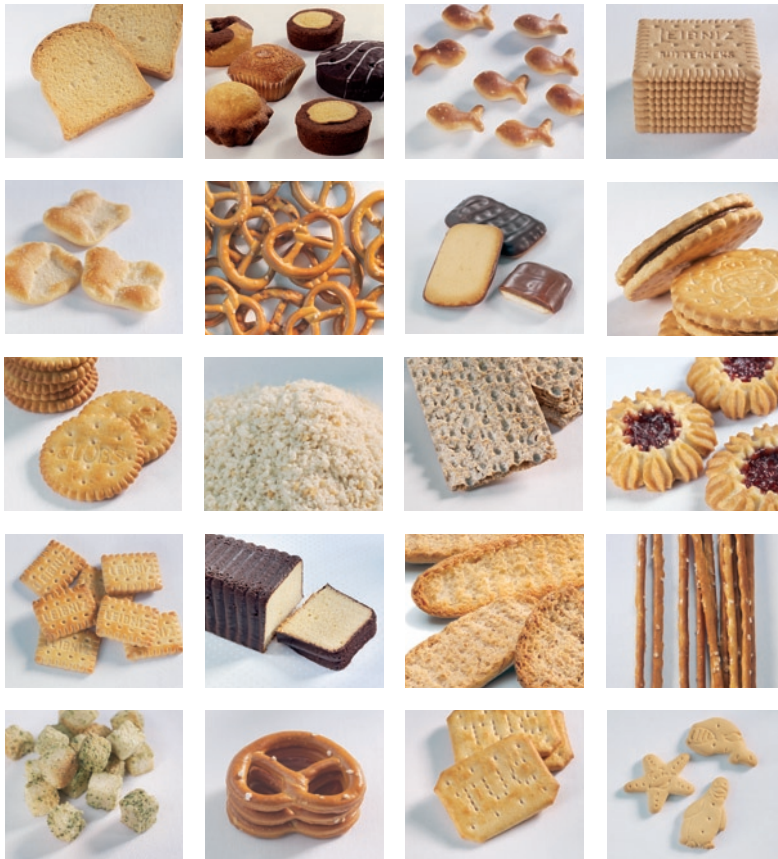

| EQUIPMENT AND MACHINES | MODULES |
|------------------------------------|--|
| _Hard biscuit/cracker lines | Mixer, continuous dough production and dough feed Laminator, rotary cutter with gauge rollers Tunnel ovens and oven combinations with various heating systems Cooling conveyors and feeding systems to the downstream processing stations (finishing, packaging, etc.) |
| _Soft biscuit lines | Mixer, continuous dough production and dough feed Biscuit moulder Equipment for deposited, wire cut and extruded baked goods Tunnel ovens and oven combinations with various heating systems Cooling conveyors and feeding systems to the downstream processing stations (finishing, packaging, etc.) |
| _Soft pretzel lines | Mixer, continuous dough production and dough feed Sticks press, biscuit moulder Lye bath with sprinkler and cutter Tunnel ovens and oven combinations with various heating systems, Cooling conveyors and feeding systems to the downstream processing stations (finishing, packaging, etc.) |
| _Cake lines | Mixer, continuous dough production and dough feed or depositing into pans Tunnel ovens Automatic depanning Product cooling, product injection, Conveyors to the downstream processing stations (finishing, packaging, etc.) |
| _Crispbread lines | Dough premixer and feeder, Crispbread moulder, Flour duster, seeder and dusting flour conditioning Dockering rollers and dough sheet cutter High temperature continuous oven Cutting, sawing and stacking machine Conveyors and feeding systems to the downstream processing stations (finishing, packaging, etc.) |
| _Rusk lines | Mixer, continuous dough production and dough feed Dough make-up, intermediate proofer, moulder Final proofer Continuous oven, transport of pans Bread depanner, bread cooling, Bread slicer and slice handling machine, Continuous toast oven Product stacking and feeding systems to the downstream processing stations (finishing, packaging, etc.) |
| _Breadcrumbs lines | Mixer, continuous dough production and dough feed Dough scaling Continuous proofer Tunnel oven Bread cooling Grinding, drying, milling |



HARD BISCUIT/CRACKER LINES

Hard biscuit/cracker lines The process of making hard biscuits or cracker starts with dough production followed by dough feed and moulding. Next, the products are transported through a rotary cutter and on into an SNK tunnel oven or any other suitable combination of ovens.

The number of oven modules or zones is depending on the necessary baking time and the desired product performance. An optimal baking process can be achieved with the right selection of zones (number of burners).

Via a cooling conveyor and a stacker the products are then moved on to the final step, the packaging.

- 1 **Two-shaft high performance ZK mixer** with PLC for 50 recipes.
The two Z-shaped mixing arms ensure homogeneous mixing of different kinds of dough.
- 2 **Vertical laminator**, available in many variants for the production of different types of crackers and hard biscuits. **Automatic dough feeding systems** with dough scaling, metal detector and dough feeding systems.
- 3 Outlet **laminator** with folded dough sheet
- 4 **Gauge rollers**
- 5 Rotary **cutter type RTA**
- 6 Rotary **double cutter Type RTAD** for stamping and cutting
- 7 **Scrap lift** and **dough return**
- 8 **Tunnel oven** in modular design with different heating options (direct, indirect, convection and combinations thereof).

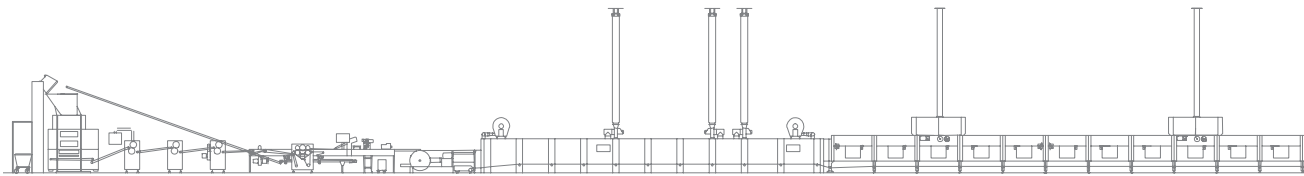

1



2



3



4



5

A large range of different types of biscuits can be produced on this **WP** equipment. It is possible to equip the line with optional units such a four roller system, coated rollers, heated rollers or cooled rollers depending on the product. A PLC allows to store the relevant production parameters independently of the recipe and to set the necessary values. It can also be combined with a cascade control.

Product examples

- **Crackers:** Cream crackers, soda crackers, cocktail crackers, mixed crackers, potato crackers, cheese crackers
- **Hard biscuits:** Traditional hard biscuits, biscuits for kids, animal biscuits, plain biscuit that can be enhanced with crème or chocolate

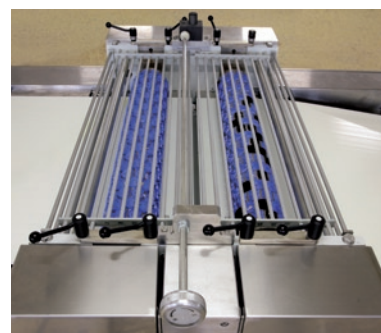
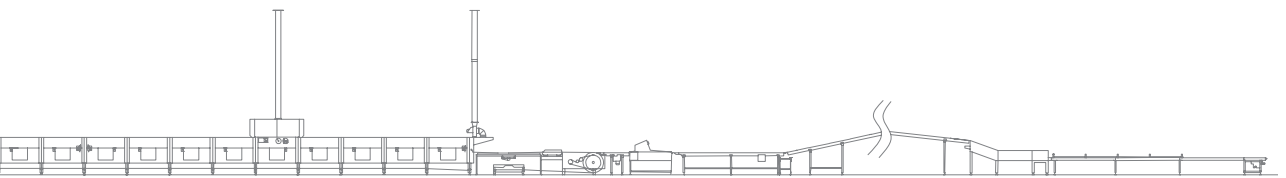

6



7



8



SOFT BISCUIT LINES

Soft biscuit lines The production process for soft biscuits starts with the production of the doughs. Next stages are dough feed, dough moulding and placing of the dough pieces onto a steel belt. The number of oven modules is depending on the necessary baking time in relation to the maximum traveling speed (performance).

After the baking, the biscuits are moved on a cooling conveyor and through a stacker to the packaging equipment.

- 1 **Batch mixer** for the production of dough for moulded biscuits.
- 2 **Biscuit moulder, dough feeding roller** and **moulding roller** for the scrapless moulding of doughs.
- 3 **Tunnel oven SNK**, ideal for the production of soft biscuits and fine bakery wares.
- 4 **Extruded biscuits**, cut at the transition to the baking belt.
- 5 Biscuits discharged from the **oven**.
- 6 Natural **cooling** and **transport** to the packaging.
- 7 Biscuits at the in-feed section of the **layering machine**.

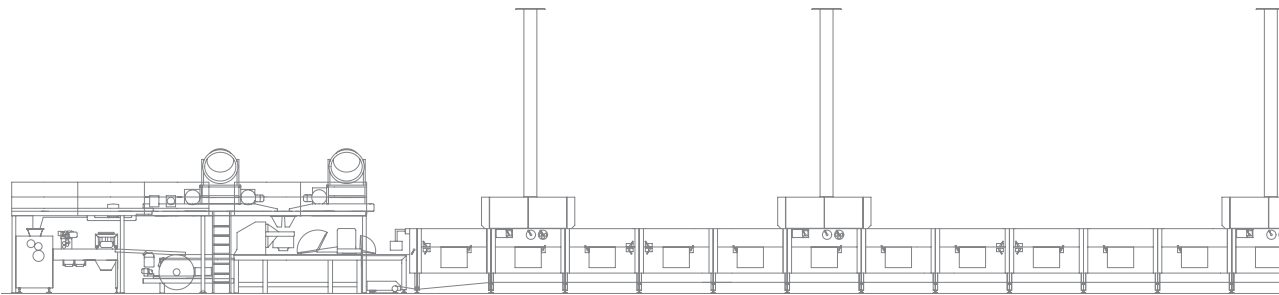

1



2



3

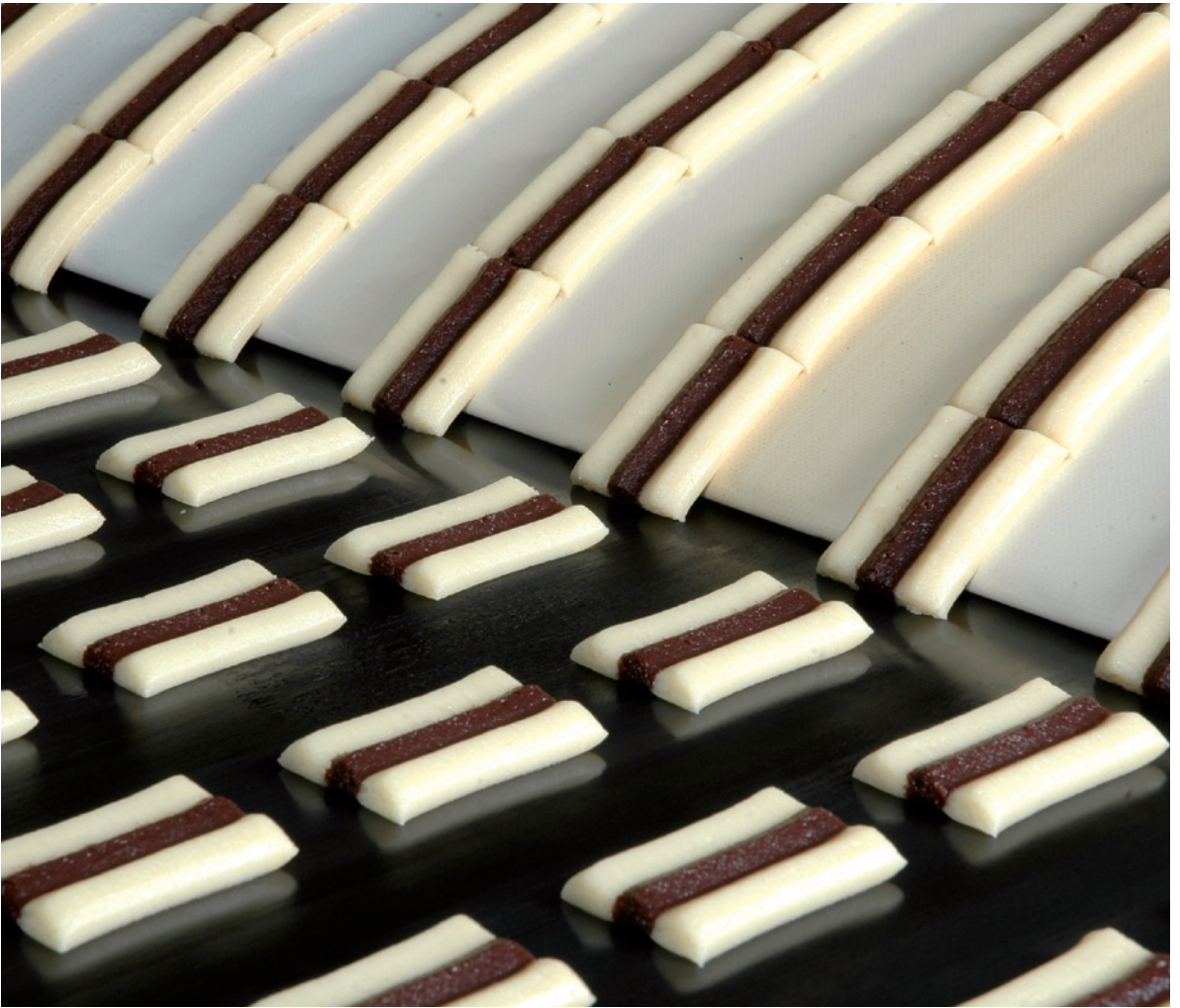

4

A large range of different types of biscuits can be produced on this **WP** equipment. The set of machines is combined based on the types of products to be produced. Additional equipment such as dusters, sprinklers, seeders or jam applicators can be provided depending on the product range. Soft biscuits and fine bakery wares are made in tunnel ovens equipped with either mesh or solid steel belts. The **WP** SNK convection oven delivers optimum baking results with uniform browning and higher output.

- Depending on the products, the different types of dough can either be moulded (moulded biscuits), wire cut (wire cut biscuits), extruded (extruded biscuits) or deposited (deposited biscuits).
- Other special products are co-extruded biscuits, these are biscuits filled with a fruit or crème filling.

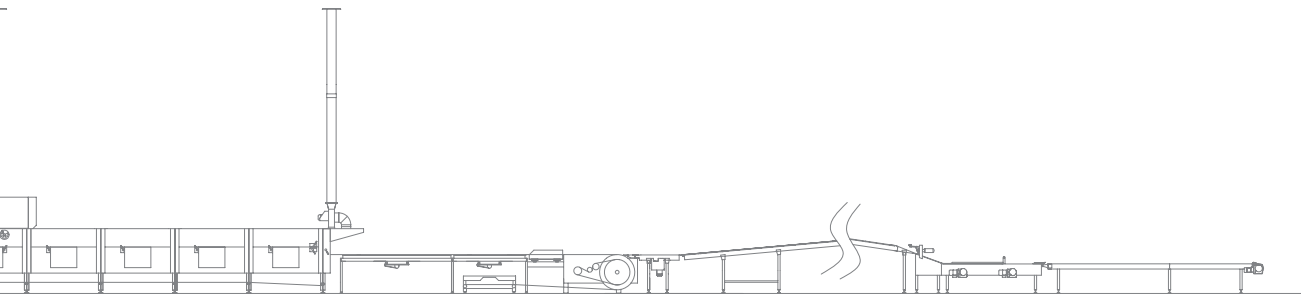

5

6

7



SOFT PRETZEL LINES

Soft pretzel lines The production of soft pretzels and similar lye-treated products starts with dough metering and extrusion. Next stations are the lye bath, the sprinkler or seeder, the cutter and finally the oven. WP is offering its SNK convection oven for this type of baked goods. For other types of lye-treated baked goods such as cocktail pretzels, different cutters or moulders can be provided.

The number of oven modules is depending on the necessary baking time in relation to the maximum traveling speed. After baking, the soft pretzel products are transported to the packaging machines. The length of the conveyors shall correspond to the required cooling time.

- 1 The **SP extruder** and a special dough metering unit ensure uniform extrusion of the dough ropes
- 2 The dough ropes are individually extruded through nozzles. **Filled sticks** are produced with special nozzles.
- 3 After extrusion the dough ropes are transported through a lye bath, sprinkled with salt and then cut with a **guillotine** to the required length.
- 4 Pretzels and other snacks can also be made with a **biscuit moulder or cutter** integrated into the line.
- 5 For higher performances the soft pretzel snacks can be produced on **rotary cutters** equipped with a **twin roller system**.
- 6 The **SNK tunnel oven** ensures proper development of the baked goods with uniform and shiny browning. Convection heat and radiation heat can be combined to ensure an optimum baking process.
- 7 Transfer of the baked sticks to the **transverse belt** with downstream cooling conveyor and transport to the packaging stations.

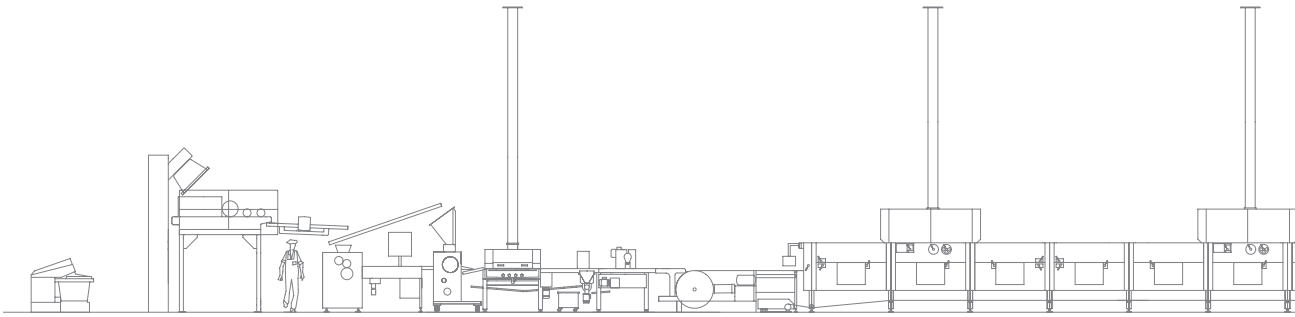

1

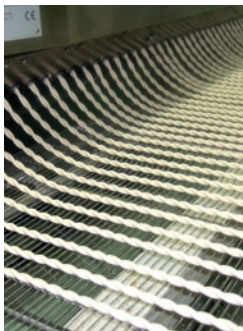

2



3



4



Lye-treated baked goods

- Pretzels moulded or cut
- Sticks extruded or cut
- Sticks coextruded with savoury filling
- Sticks coextruded with sweet filling
- Application of salt, sesame seeds, cheese or mixed spices

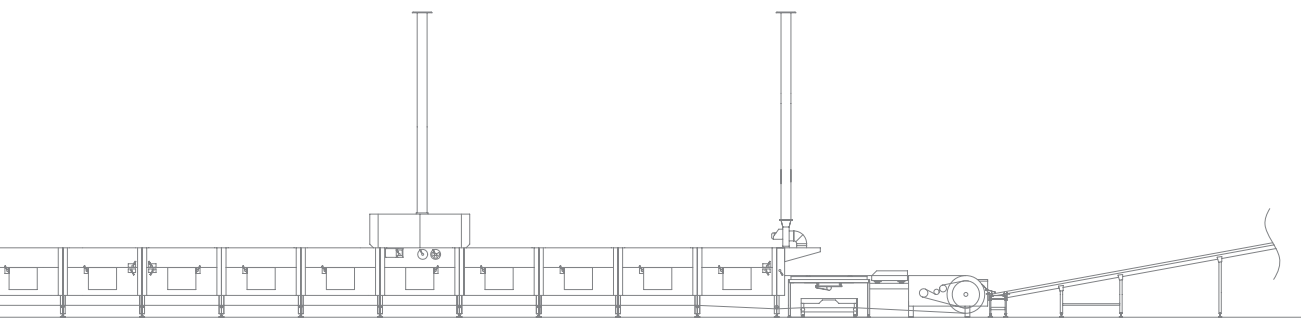

5



6

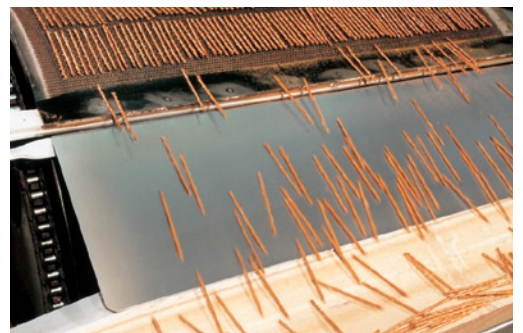

7



CAKE LINES

Cake lines The production line for cakes starts with dough production, dough feed and shaping of the dough or depositing into pans. After baking the cakes are depanned, cooled down and then sent to the packaging machines.

The size and length of the continuous oven is depending on the necessary baking time in relation to the desired production performance.

Processing stations:

(cup cake production)

- 1 Dough production in a **vertical batch mixer**
- 2 Dough depositing into pans with a **filling machine**
- 3 **Oven loader**
- 4 **Tunnel oven**
- 5 **Product cooling**
- 6 **Product injection**
- 2 **Depanner**
- 8 Transport to the **packaging machines**
- 9 **Pan turning unit**
- 10 **Pan washer**
- 11 **Pan oiler**

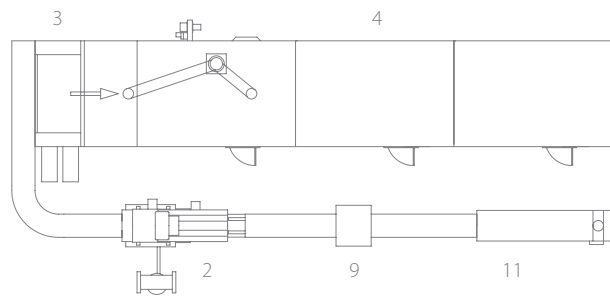
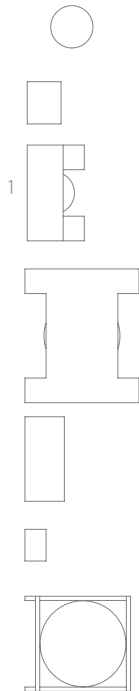

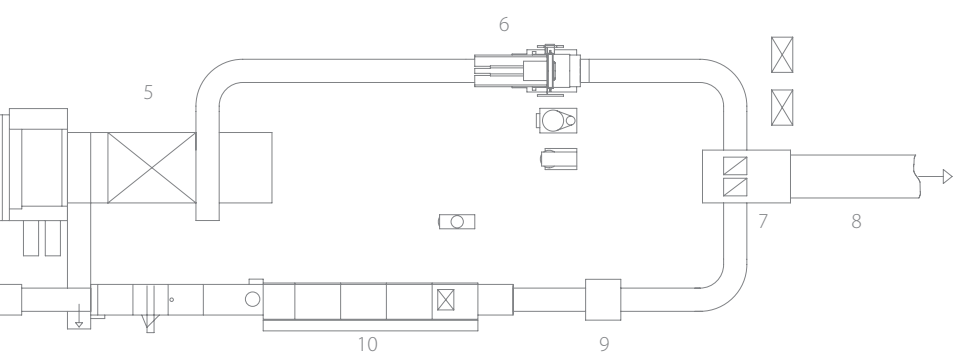

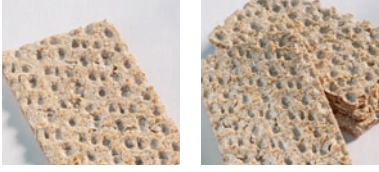

CRISPbread LINES

Crispbread lines The production process for crispbread starts with the production of the dough. Next stations are dough aeration, cooling and application as well as several flour dusting and seeding processes followed by a special high temperature tunnel oven.

The number of heating zones or the length of the continuous oven is depending on the necessary baking time in relation to the desired production performance.

After baking, the crispbread sheets are broken, sawn, cooled and transported to the downstream stations for cutting, stacking and packaging.

Processing stations:

(special type of crispbread production)

- 1 Dough production with **pre-mixer**, soaking vessel, combination unit for cooling and aeration.
- 2 **Flour duster** for top and bottom flour application and **seeder**. The endless dough sheet produced with a **special dough sheet former** is placed on a layer of dusting flour.
- 3 A synchronously running **pair of docking rollers** with cleaning device produces the typical crispbread appearance.
- 4 **Suction unit** to remove dusting flour from the dough surface. The removed excess dusting flour is recycled and reused.
- 5 The **special high temperature crispbread oven** is equipped with two gas burners each for top and bottom heat. After baking the sheets are sawn in a **transverse and longitudinal cutting unit** to the final format.
- 6 Via a **collation unit** and **conveyors** the crispbread slabs are transported to the packaging machine.

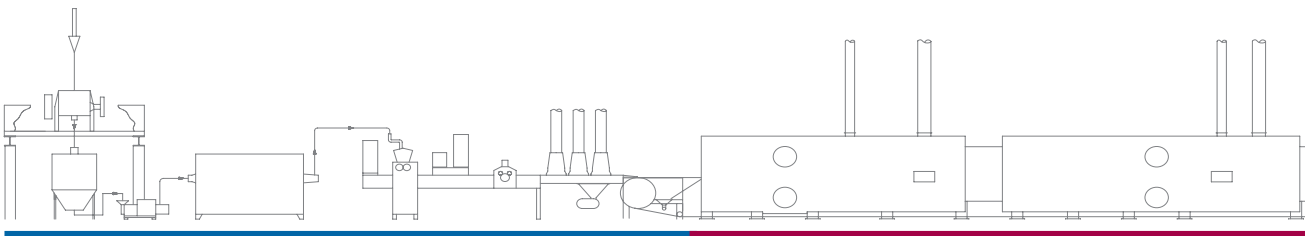

1



2

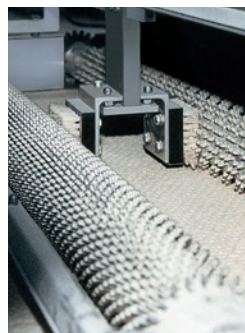

3



4



Types of crispbread:

- Crispbread with milk
- Crispbread with spelt
- Crispbread with sesame seeds
- Crispbread with caraway
- Crispbread with dietary fiber

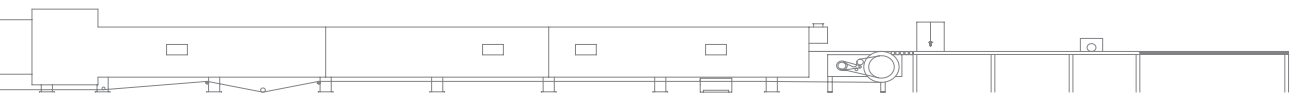

5



5



6



RUSK LINES

Rusk lines The production process for rusk starts with dough production. Next stations are dough feed and moulding. The dough is proofed and baked in pans. After baking the bread loaves are depanned, cooled and sliced. In a second baking process the slices are toasted and then transported to the packaging machines.

The dimension (size and length) of the oven is depending on the necessary baking time in relation to the desired production performance.

- 1 **Mixing unit** with spiral mixer
- 2 Dough make-up with **dough divider and moulder, conical rounder, intermediate proofer, sheeter** and depositing of the dough pieces into pans
- 3 **Final proofer**
- 4 **Tunnel oven**
- 5 **Bread depanner**
- 6 **Bread cooler, slicer and slice handling unit**
- 7 **Toast oven**
- 8 **Product stacking**
- 9 **Packaging**

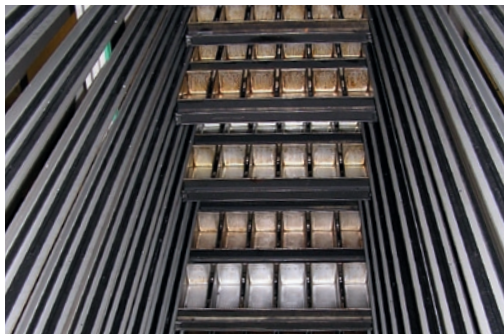
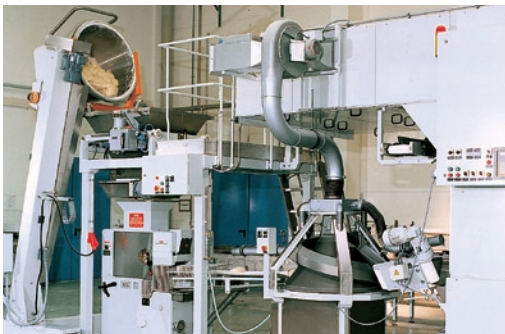
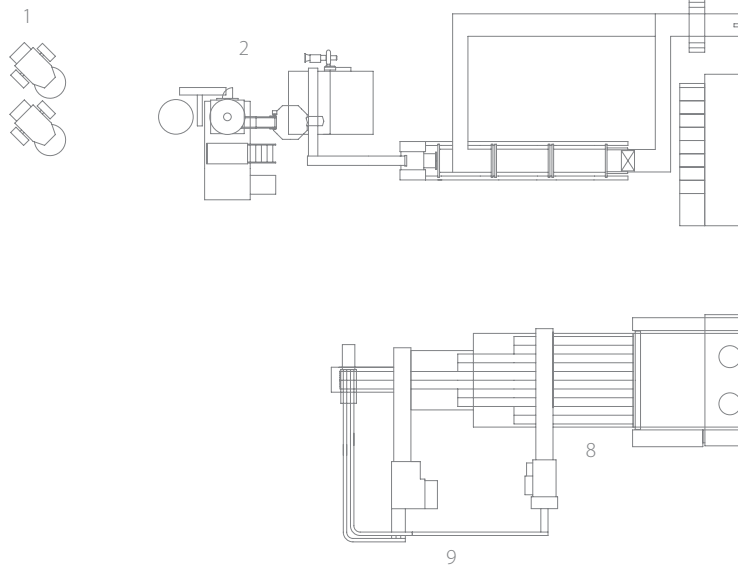



6

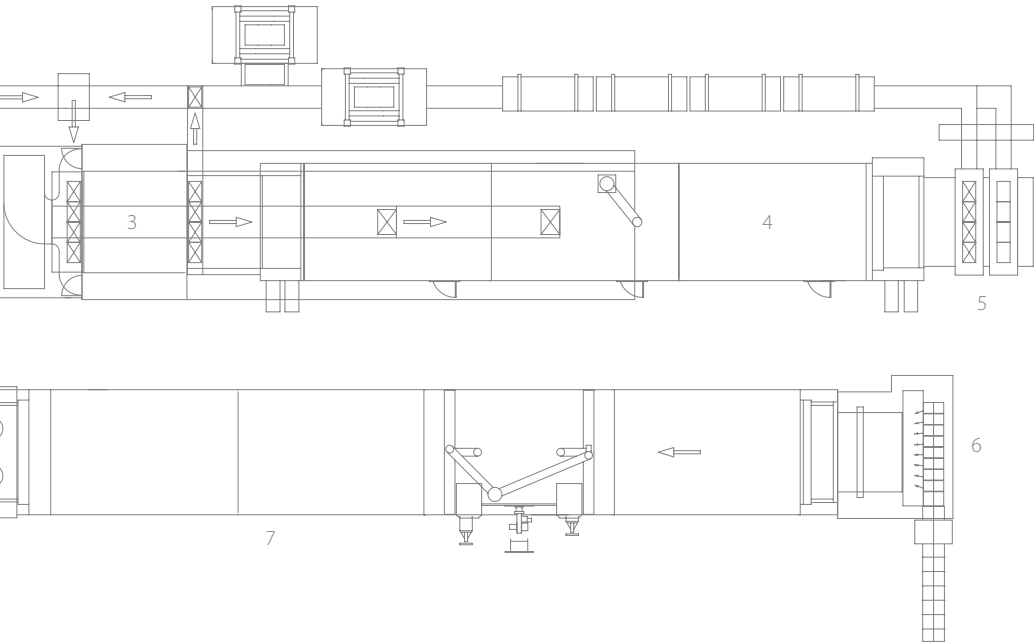

5

6

7



BREADCRUMB LINES

Breadcrumb lines In general, a continuous mixer is the starting point of the production line. Next are dough feeding and moulding. A continuous proofer is used for the proofing process which is followed by a tunnel oven.

For the process described here, first individual bread loaves are baked which are cooled down after baking. Then they are coarsely ground and the pieces dried, milled and packed.

The dimension (size and length) of the oven is depending on the necessary baking time in relation to the desired production performance.

- 1 Continuous dough production in the **ZPM mixer**
- 2 **Scaling**
- 3 **Transfer** from the continuous proofer to the oven
- 4 Oven outlet section with **bread conveyor**
- 5 **Tunnel oven**

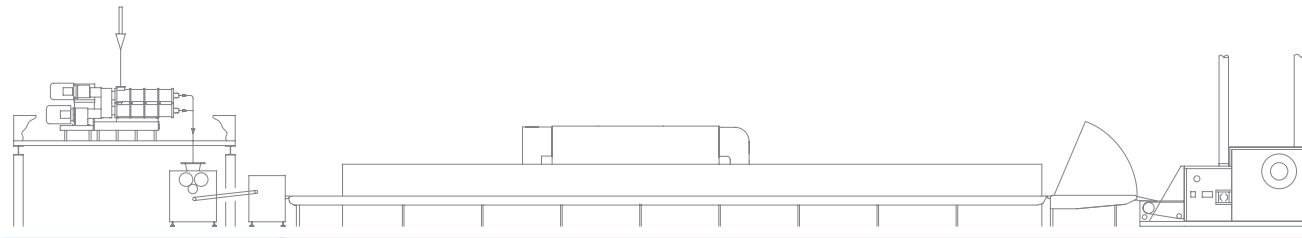

1



2



3

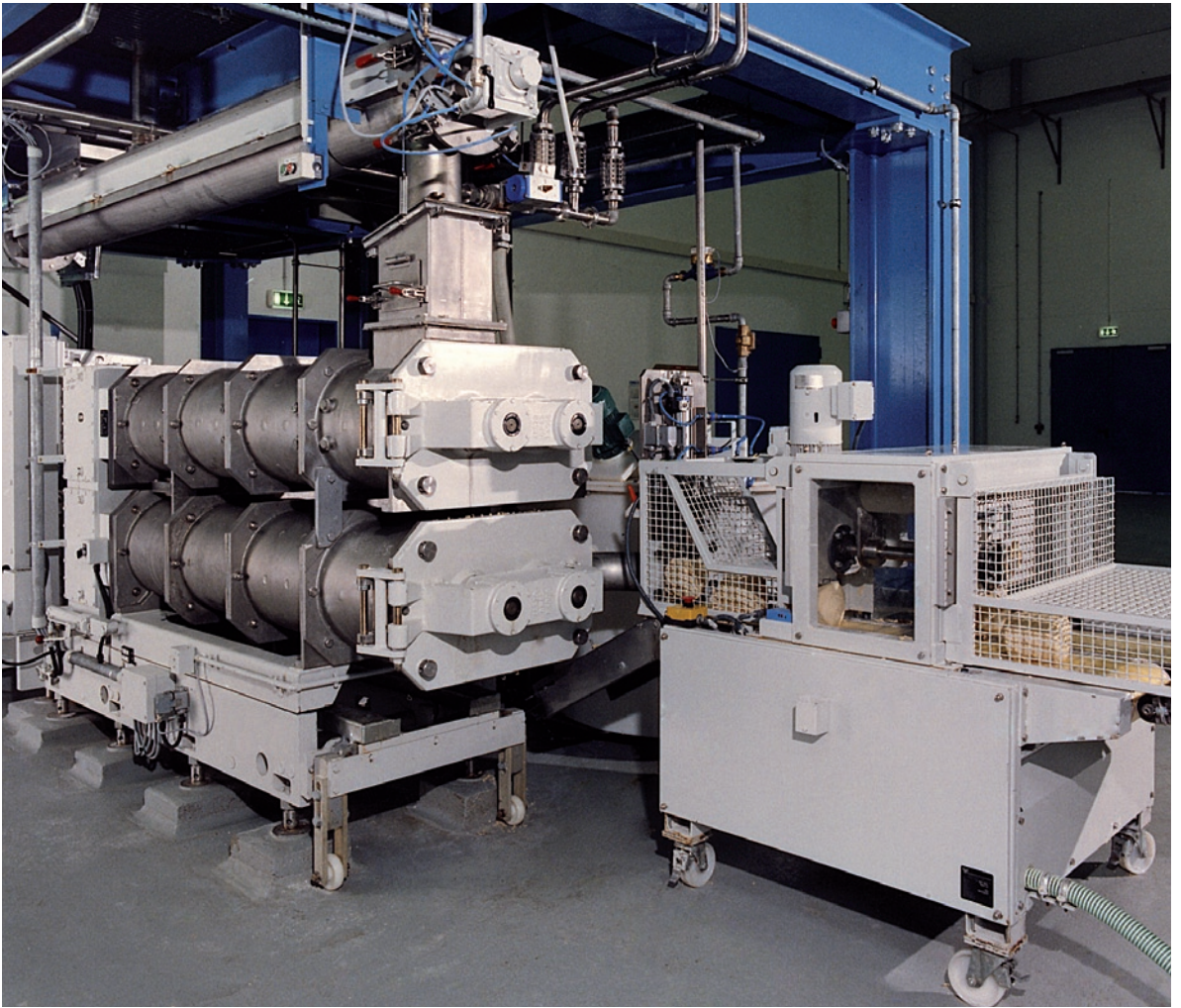

1

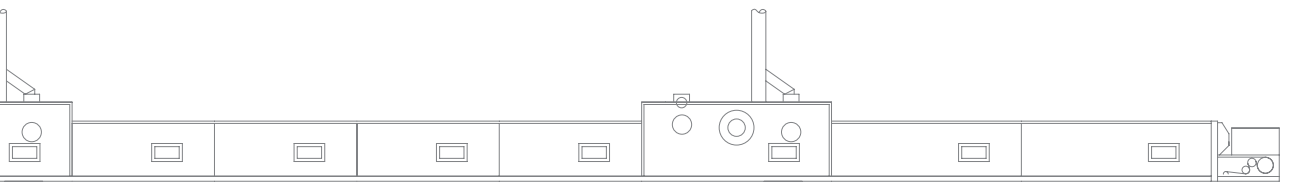

4



5

AUTOMATION

Convenient operation, complete reproducibility of product qualities and excellent availability characterize the industrial equipment provided by **Werner & Pfleiderer**. These features are also directly related to the lines' high degree of automation. Controlling, measuring, adjusting – all parameters can monitored and corrected automatically by the control system or manually by the line operator. A wealth of different sensors permanently monitors the quality relevant parameters of the production process including dough quality and performance, thickness, width and speed of the dough sheet, humidity and temperature inside the oven, moisture and temperature of the product. The lines' modules react immediately to the obtained results and modify their settings – a completely self-regulating system.

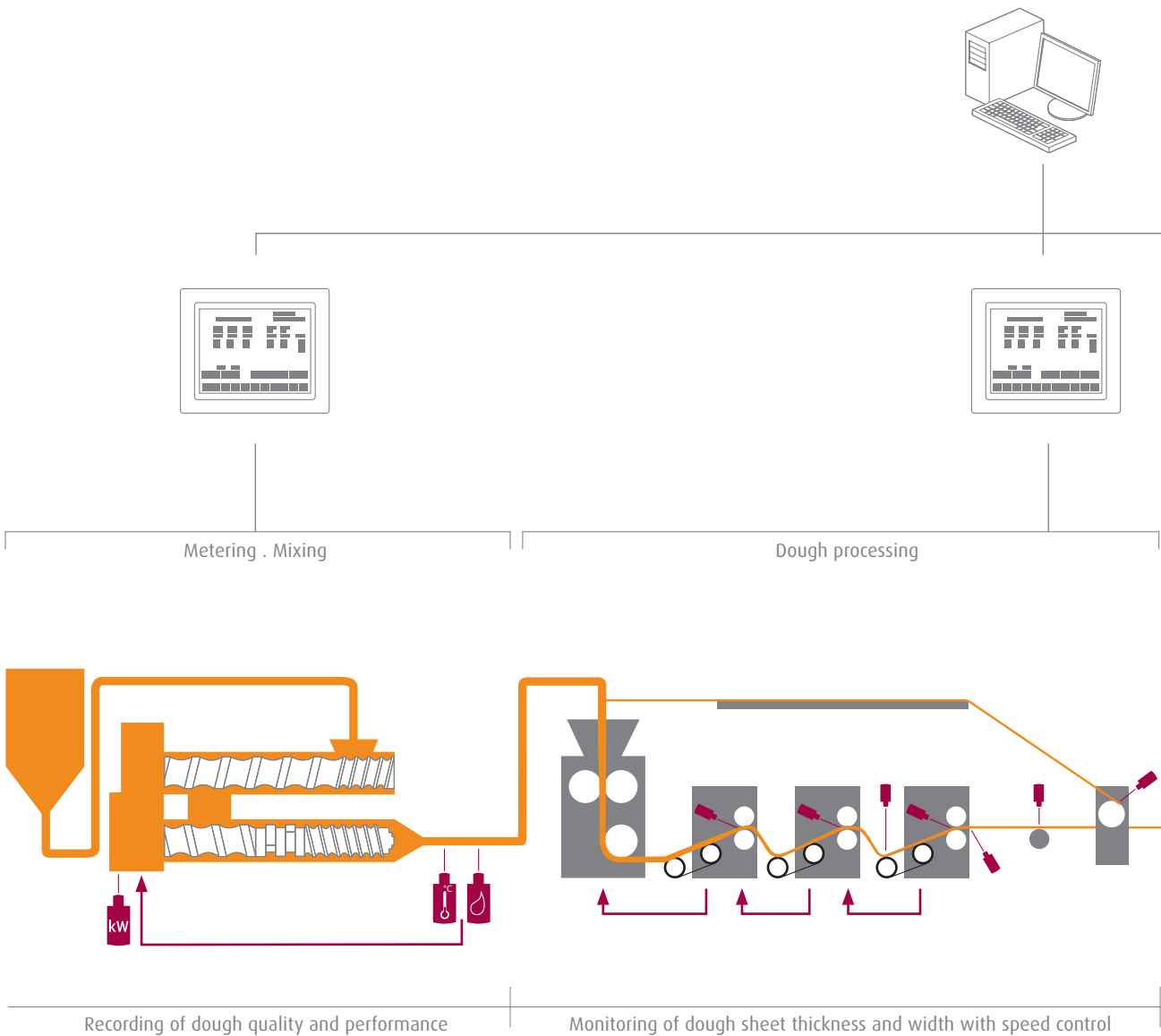

The entire production process is documented in detail. It can be monitored by the authorized line operator and his supervisor and manually corrected, if needed. Via internet the entire automation system can be remote controlled and maintained.

Werner & Pfleiderer Industrial Bakery Technologies turns special customer requirements into different productions lines with the desired degree of automation.

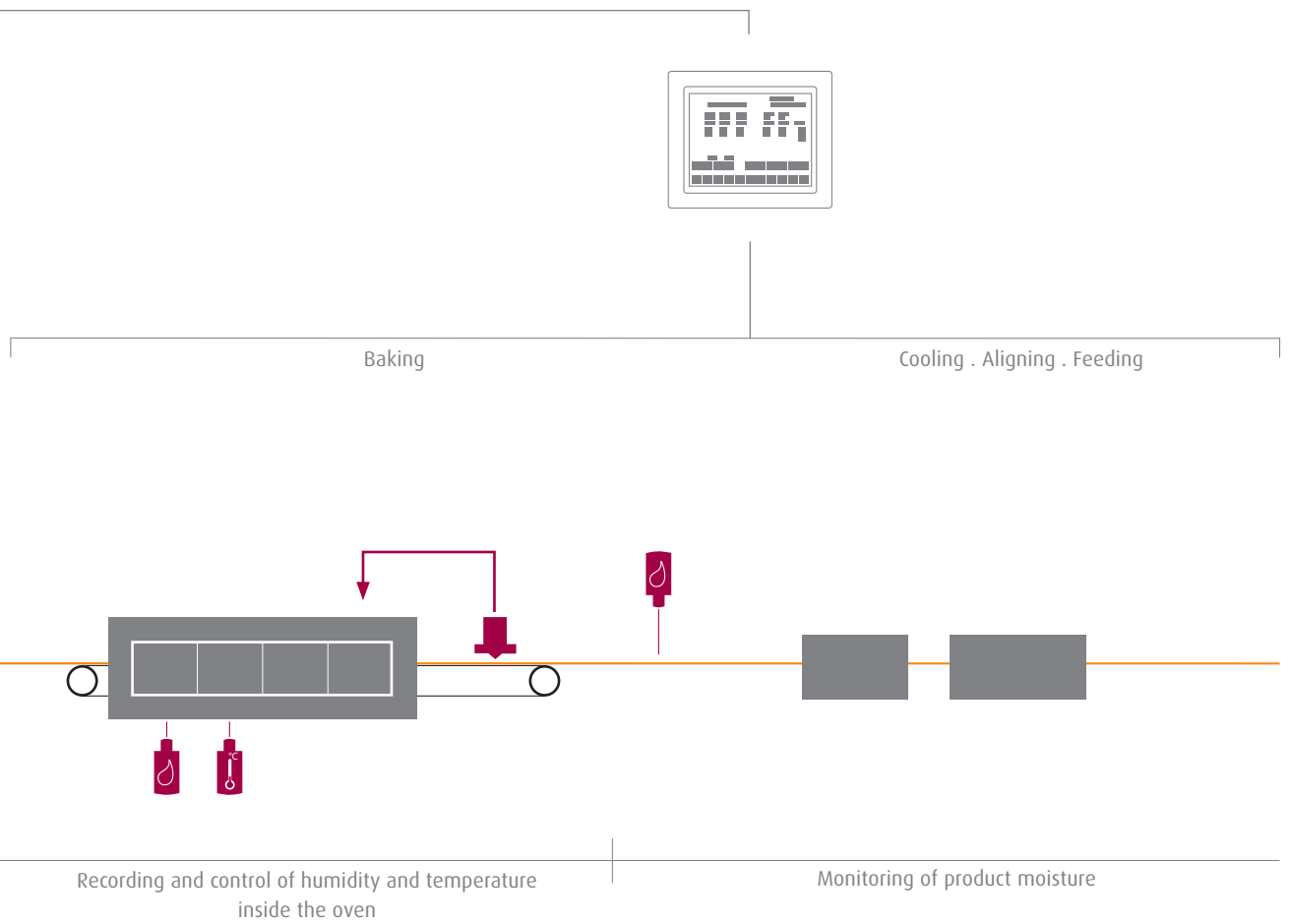

WP BAKERYGROUP

Werner & Pfeiderer
Industrielle Backtechnik GmbH
 Frankfurter Straße 17
 71732 Tamm
 Germany

Fon +49 (0) 71 41-202-0
 Fax +49 (0) 71 41-202-111
 info@wpib.de
 www.wpib.de

*The **WP BAKERYGROUP** has subsidiaries in France, Italy, Belgium, Russia and the USA.*

You will also find dealerships with service stations all over the world.

 **Werner & Pfeiderer**
Bakery Technologies

 **Werner & Pfeiderer**
Industrial Bakery Technologies

 **Werner & Pfeiderer**
Bakery Cooling

 **Werner & Pfeiderer**
Instore Baking

 **Werner & Pfeiderer**
Bakery Service

 **Haton**

 **Kemper**

 **Winkler**

 **BackNet**
Bakery Software

www.wpbakerygroup.com